

BrassCraft®



Brass Fittings

Innovative solutions delivered

Better engineering, better selection, better results



FLARE

COMPRESSION

CPVC

IRON PIPE

HOSE BARB

GARDEN HOSE

DRAIN/SHUT-OFF COCKS

NEEDLE & HUMIDIFIER VALVES

BRASSCRAFT

THE PROFESSIONAL'S HEAD START

The Professional's Head Start

Our clearly illustrated, easy-to-use catalogs are an important part of the BrassCraft leadership tradition – versatile, highly effective products that can help make your job easier and more rewarding. With BrassCraft catalogs by your side, finding and ordering the right plumbing products for every application is faster and simpler than ever before.

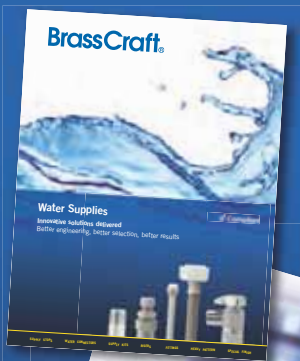

WATER SUPPLIES

An invaluable, one-stop resource for plumbing professionals.

- Supply Stops
- Water Connectors
- Supply Kits
- Risers
- Fittings
- Heavy Pattern
- Special Finish

GAS APPLIANCE & WATER HEATER CONNECTOR

A complete source for BrassCraft stainless steel gas connectors.

- Gas Connectors
- Water Heater Connectors
- Gas Valves
- Excess Flow Valves
- Tankless Service Valves
- Installation Kits

BRASS FITTINGS

A comprehensive catalog featuring a full line of reliable, easy-to-install fittings and products.

- Flare
- Compression
- CPVC
- Iron Pipe
- Hose Barb
- Garden Hose
- Drain/Shut-off Cocks
- Needle & Humidifier Valves

BRASS FITTINGS

Table of Contents

BrassCraft®

Flare	4-14	Waste Connector	42-44
Compression	15-26	Drain & Shut-Off Cocks.....	45
CPVC	27	Needle & Humidifier Valves	46-48
Iron Pipe	28-34	Displays.....	49
Hose Barb.....	35-38	Specifications	50-57
Garden Hose.....	39-41	Index	58-66

BrassCraft®

Manufacturing Techniques

Extruded Fittings

Extruded brass rod is drawn to custom shapes with precise tolerances. This eliminates splits, pin holes and sand holes. BrassCraft Mfg. then machines the extruded brass rods using many different machining operations. The result is a one-piece, solid brass fitting without seams or brazed joints.

BrassCraft Mfg.'s process of machining fittings from extruded brass rod produces a fitting that's dense, nonporous and stronger in it's longitudinal direction.



Forged Fittings

Forged brass fittings are made from extruded brass rod that have different temper and chemical composition than brass rod used for the extruded fittings. The bars are cut to the correct length slug for the fitting, heated to a pliable state and pressed between dies with 25,000 pounds per square inch pressure. Next they are cooled, then the flash is trimmed and the forging blank is machined into the finished fitting.

Compliant Solutions for the 2014 No-Lead Law



As of January 4, 2014, Federal Public Law 111-380 prohibits the sale of plumbing fixtures with a wetted surface area containing more than a weighted average of 0.25% lead. This law virtually eliminates the lead content of pipes, pipe fittings, plumbing fittings and fixtures intended to convey or dispense water for drinking or cooking.

BrassCraft Manufacturing is meeting the new no-lead law head on with a comprehensive range of compliant products including brass stops, braided water connectors, brass fittings, and hot water heater connectors.

Look for the checkmark ✓ on packaging to verify that the product meets the new no-lead legislation requirements. Look for the ● next to products listed in this catalog that meet the new no-lead regulations.

Dryseal Pipe Threads

BrassCraft® tapered pipe threads are made to the American National Standard B1.20.3, Dryseal Pipe Thread standard, known as either NPTF, or in the SAE short version, PTF.

Unlike other types of threads, Dryseal pipe threads seal joints pressure-tight, because their thread roots are wider than the crests. Wrenching the threads together causes the roots to crush the sharper crests of the mating threads, forming a metal-to-metal seal. Dryseal threads improve sealing characteristics, but using a thread sealant is still recommended.



Dryseal pipe threads, hand tight. Does not provide a positive seal.



Regular pipe threads, hand tight. Only seals joints on the sides of the threads, allowing spiral leakage



Dryseal pipe threads, wrench tight. Tightly seals all thread surfaces, providing a positive seal.

Your Best Choice for Engineered Product Solutions

BrassCraft Mfg. has been providing quality engineered product solutions to customers since 1946. Offering a full range of machining capabilities, we manufacture an array of brass alloys including compliant, no-lead alloys for potable water applications. BrassCraft Mfg. also provides collaborative design and engineering services for a wide spectrum of products and applications.



Manufacturing Expertise

With a broad range of machining, finishing and assembly capabilities, we provide comprehensive solutions to your product needs. More than one million square feet of manufacturing, packaging and distribution facilities means we have the flexibility to effectively respond to your production needs, with stringent quality control and prompt service.

Breadth of Line

BrassCraft Mfg. offers customers a comprehensive product line. The ability to source globally and manufacture products to exact specifications makes the program even more complete by providing customers with added product selection and competitive pricing.

Global Sourcing

When customers request a product that we do not inventory, the customer is accommodated, not turned away. With business partners across the globe, BrassCraft Mfg. can source any product to satisfy our customers' needs.

Custom Engineered Products

Our expertise in product design and manufacturing offers customers assistance in any stage of the product development process. With a full suite of specialty and finishing operations, BrassCraft Mfg. can modify an existing part or manufacture to a customer's specifications.

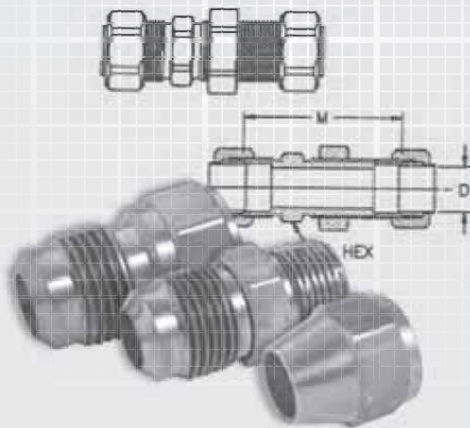

Brass 45° Flare Fittings



Product Applications

- For use with copper, brass, aluminum and welded steel tubing that can be flared.
- Used extensively for connections of fuel, oil, air, liquid petroleum (LP), and natural gas lines.

Product Advantages

- BrassCraft® Flare Fittings resist mechanical pull out.
- Recommended for higher pressures than those covered by compression fittings.
- Designed to be assembled and disassembled over and over again.
- Reusable with long or short nuts.
- Manufactured from brass rod.
- Backed by BrassCraft Mfg.'s 65 plus year history and reputation for quality and service.

Special Orders

- Special fitting configurations and sizes may be ordered. Please furnish a print or sketch of your needs with your inquiry.
- Fittings are available in bulk quantities on request. Contact your sales representative for details.

How To Order

- Order fittings by part number and product name.
- Flare bodies and nuts are separate items and are ordered individually. (Indicate both part numbers – body and nut – when ordering).
- To order flare fittings with nuts assembled, add suffix "WN".

Assembly Instructions

1. Cut tubing to required length, making sure that the ends are square and all burrs are removed.
2. Slide nut onto tubing. Threaded end of nut must face out.
3. Flare tubing end with a 45° flaring tool.
 - A. Measure flare diameter.
 - B. Check flare for excessive thin out.
4. Lubricate threads with a drop of oil and assemble nut onto body, hand tighten.
5. Tighten with wrench until assembly feels "solid". Then apply a one-sixth turn.

CAUTION: Do not over torque. May damage the fitting and split the tubing at the flare.

HINT!

Single or Double Flares?

Tubing may be either single or double flared for maximum reliability. When working with steel tubing, such as Bundy, double flaring is recommended to protect against tube cracking or splitting. Single flares are commonly used to connect copper and aluminum tubing.

Double Flare Eliminates the Danger of Over Tightening

The advantage of a double flare is that an effective seal can be made with specified wrench torques, and yet maximum wrench torques for single flares can be exceeded by a considerable margin without "ironing out" or "washing out" the flare. The double flare compensates for this over-torquing while maintaining a reliable seal. The double flare is also desirable for tubing joints which must be taken apart and reassembled frequently, especially on 3/8" OD tube size or smaller.

Part Numbering System

Iron Pipe Nipples

Fitting Type	Pipe Thread	Length	Finish	Option
113	-06-	2.5	-C-	X

Type	112	Close Pipe Nipples
	113	Long Pipe Nipples

Pipe Thread	02	1/8" Male Iron Pipe
	04	1/4" Male Iron Pipe
	06	3/8" Male Iron Pipe
	08	1/2" Male Iron Pipe
	10	5/8" Male Iron Pipe
	12	3/4" Male Iron Pipe
	16	1" Male Iron Pipe

Length*	1.5	1-1/2"
	2	2"
	2.5	2-1/2"
	3	3"
	3.5	3-1/2"
	4	4"
	4.5	4-1/2"
	5	5"
	5.5	5-1/2"
	6	6"

Finish	C	Chrome plated
	R	Rough (unplated)

Option	X	100% Compliant
(Modifier)		

*For Close Nipples, omit length

Working Pressures

Working pressures vary by type and size of tubing used, and style of fitting. However, based on .032 wall copper tubing, the pressures may range as follows depending on size:

CONNECTION TYPE PRESSURE	WORKING
Flare (1/8" to 3/4")	600 to 3,000 PSI
Compression	100 to 400 PSI
Iron Pipe	Up to 1,200 PSI
PEX Tubing	Up to 150 PSI
Polyethylene Tubing	Up to 80 PSI

Industry Standard Fittings

Fitting Type	Inlet Size	Outlet Size	Option	Finish
69	-8-	6	-X-	C

Type	62	Compression x Compression Union
	65	Compression x Compression Elbow
	68	Male Iron Pipe x Compression Union
	69	Male Iron Pipe x Compression Elbow
	70	Female Iron Pipe x Compression Elbow
	462	Flare x Compression Union Adaptor

Inlet Size	4	1/4"
	6	3/8"
	8	1/2"
	10	5/8"
	12	3/4"
	14	7/8"

Outlet Size	4	1/4"
	6	3/8"
	8	1/2"
	10	5/8"
	12	3/4"
	14	7/8"

Option	DT	Drill Through
(Modifier)	X	100% Compliant

Finish	C	Chrome plated
	R	Rough (unplated)

Fitting Thread Size Comparison Chart

SIZE	FLARE	COMPRESSION	PIPE
1/8	5/16-24	5/16-24	1/8-27
3/16	3/8-24	3/8-24	—
1/4	7/16-20	7/16-24	1/4-18
5/16	1/2-20	1/2-24	—
3/8	5/8-18	9/16-24	3/8-18
7/16	11/16-16	5/8-24	—
1/2	3/4-16	11/16-20	1/2-14
5/8	7/8-14	13/16-18	—
3/4	1-1/16-14	1-18	3/4-14
7/8	1-1/4-12	1-1/8-18	—
1	1-3/8-12	—	1-11-1/2

General Information

Most brass fittings have a temperature range of -65°F to 250°F. They can be used on copper, brass, aluminum, plastic, and welded steel.

Note: Compression fittings are not recommended for steel tubing.



PART NO.	USE	UPC	DESCRIPTION	FINISH	QTY	LBS
Flare Plugs						
39-4	○	026613024608	1/4" OD Tube	Rough	10	0.2
39-5	○	026613058757	5/16" OD Tube	Rough	10	0.3
39-6	○	026613005690	3/8" OD Tube	Rough	10	0.5
39-8	○	026613005706	1/2" OD Tube	Rough	10	0.8
39-10	○	026613005713	5/8" OD Tube	Rough	10	1.3



PART NO.	USE	UPC	DESCRIPTION	FINISH	QTY	LBS
Flare Caps						
40-3	○	026613058764	3/16" OD Tube	Rough	10	0.2
40-4	○	026613004914	1/4" OD Tube	Rough	5	0.1
40-5	○	026613058771	5/16" OD Tube	Rough	10	0.4
40-6	○	026613004921	3/8" OD Tube	Rough	10	0.4
40-6X	▲	026613141077	3/8" OD Tube	Rough	10	0.4
40-8	○	026613004938	1/2" OD Tube	Rough	10	0.4
40-10	○	026613004945	5/8" OD Tube	Rough	5	0.6



PART NO.	USE	UPC	DESCRIPTION	FINISH	QTY	LBS
Flare Nuts - Short						
41S-2	●	026613058863	1/8" OD Tube	Rough	10	0.1
41S-3	●	026613058870	3/16" OD Tube	Rough	10	0.1
41S-4	●	026613004952	1/4" OD Tube	Rough	10	0.3
41S-5	●	026613004969	5/16" OD Tube	Rough	10	0.4
41S-6	●	026613004976	3/8" OD Tube	Rough	10	0.5
41S-7	●	026613004983	7/16" OD Tube	Rough	10	0.7
41S-8	●	026613004990	1/2" OD Tube	Rough	10	0.7
41S-10	●	026613005003	5/8" OD Tube	Rough	5	0.5
41S-12	●	026613058849	3/4" OD Tube	Rough	10	2.0
41S-14	●	026613058856	7/8" OD Tube	Rough	10	3.6
41S-6X	●	026613058900	3/8" OD Tube, Heavy Pattern	Rough	10	0.6
41S-8X	●	026613058955	1/2" OD Tube, Heavy Pattern	Rough	10	0.9



PART NO.	USE	UPC	DESCRIPTION	FINISH	QTY	LBS
Flare Nuts - Long						
41L-4	●	026613058795	1/4" OD Tube	Rough	10	0.3
41L-5	●	026613058801	5/16" OD Tube	Rough	10	.01
41L-6	●	026613058818	3/8" OD Tube	Rough	10	0.7
41L-8	●	026613058825	1/2" OD Tube	Rough	10	1.3
41L-10	●	026613058788	5/8" OD Tube	Rough	10	1.8



PART NO.	USE	UPC	DESCRIPTION	FINISH	QTY	LBS
Flare Bonnets						
FB-5	○	026613059013	For 5/16" OD Tube	Rough	10	.03
FB-6	○	026613005850	For 3/8" OD Tube	Rough	10	0.1
FB-8	○	026613005867	For 1/2" OD Tube	Rough	10	0.1



PART NO.	USE	UPC	DESCRIPTION	FINISH	QTY	LBS
Flare Unions						
42-2	○	026613060132	1/8" OD Tube, Both Ends	Rough	10	0.2
42-3	○	026613060149	3/16" OD Tube, Both Ends	Rough	10	0.2
42-4	○	026613005010	1/4" OD Tube, Both Ends	Rough	10	0.3
42-5	○	026613005027	5/16" OD Tube, Both Ends	Rough	10	0.5

○ Not for use in potable water applications.

● Can be used in potable water applications.

▲ Certified Compliant to NSF/ANSI 372 for potable water applications

PART NO.	USE	UPC	DESCRIPTION	FINISH	QTY	LBS
Flare Unions (cont.)						
42-6	○	026613005034	3/8" OD Tube, Both Ends	Rough	10	0.8
42-8	○	026613005041	1/2" OD Tube, Both Ends	Rough	10	1.5
42-10	○	026613005058	5/8" OD Tube, Both Ends	Rough	5	1.0
42-12	○	026613060095	3/4" OD Tube, Both Ends	Rough	5	1.8
42-14	○	026613060125	7/8" OD Tube, Both Ends	Rough	5	2.2



Flare Reducing Unions						
42-5-4	○	026613061023	5/16" OD Tube x 1/4" OD Tube	Rough	25	1.0
42-6-4	○	026613005065	3/8" OD Tube x 1/4" OD Tube	Rough	10	0.6
42-6-5	○	026613060187	3/8" OD Tube x 5/16" OD Tube	Rough	10	0.7
42-8-4	○	026613005072	1/2" OD Tube x 1/4" OD Tube	Rough	10	0.7
42-8-6	○	026613005089	1/2" OD Tube x 3/8" OD Tube	Rough	10	1.1
42-10-6	○	026613005096	5/8" OD Tube x 3/8" OD Tube	Rough	5	0.8
42-10-8	○	026613005102	5/8" OD Tube x 1/2" OD Tube	Rough	5	0.9
42-12-8	○	026613060118	3/4" OD Tube x 1/2" OD Tube	Rough	5	1.4
42-12-10	○	026613060101	3/4" OD Tube x 5/8" OD Tube	Rough	5	1.2



Flare Female Adaptors						
46-4-4	○	026613060255	1/4" OD Tube x 1/4" FIP	Rough	10	0.4
46-6-6	○	026613005225	3/8" OD Tube x 3/8" FIP	Rough	10	0.6
46-8-8	○	026613005270	1/2" OD Tube x 1/2" FIP	Rough	10	1.1
46-12-12	○	026613060224	3/4" OD Tube x 3/4" FIP	Rough	5	1.1



Flare Female Reducing Adaptors						
46-3-2	○	026613060248	3/16" OD Tube x 1/8" FIP	Rough	10	0.4
46-4-2	○	026613005331	1/4" OD Tube x 1/8" FIP	Rough	10	0.4
46-4-6	○	026613060262	1/4" OD Tube x 3/8" FIP	Rough	10	0.8
46-4-8	○	026613060279	1/4" OD Tube x 1/2" FIP	Rough	10	1.0
46-5-4	○	026613060293	5/16" OD Tube x 1/4" FIP	Rough	10	0.7
46-6-12	○	026613005249	3/8" OD Tube x 3/4" FIP	Rough	10	0.9
46-6-2	○	026613060309	3/8" OD Tube x 1/8" FIP	Rough	10	0.6
46-6-4	○	026613005218	3/8" OD Tube x 1/4" FIP	Rough	10	0.5
46-6-8	○	026613005232	3/8" OD Tube x 1/2" FIP	Rough	10	0.9
46-8-12	○	026613005287	1/2" OD Tube x 3/4" FIP	Rough	10	1.3
46-8-4	○	026613005256	1/2" OD Tube x 1/4" FIP	Rough	10	1.0
46-8-6	○	026613005263	1/2" OD Tube x 3/8" FIP	Rough	10	0.8
46-10-6	○	026613005294	5/8" OD Tube x 3/8" FIP	Rough	5	0.7
46-10-8	○	026613005300	5/8" OD Tube x 1/2" FIP	Rough	10	1.1
46-12-8	○	026613060231	3/4" OD Tube x 1/2" FIP	Rough	5	1.5
46-10-12	○	026613005317	5/8" OD Tube x 3/4" FIP	Rough	10	1.3
46-14-12	○	026613005324	7/8" OD Tube x 3/4" FIP	Rough	5	1.8



Flare Male Adaptors						
48-2-2	○	026613060453	1/8" OD Tube x 1/8" MIP	Rough	10	0.3
48-4-4	○	026613005348	1/4" OD Tube x 1/4" MIP	Rough	10	0.4
48-6-6	○	026613005386	3/8" OD Tube x 3/8" MIP	Rough	10	0.7



○ Not for use in potable water applications.



PART NO.	USE	UPC	DESCRIPTION	FINISH	QTY	LBS
Flare Male Adaptors (cont.)						
48-8-8	○	026613005430	1/2" OD Tube x 1/2" MIP	Rough	10	1.1
48-12-12	○	026613060422	3/4" OD Tube x 3/4" MIP	Rough	5	1.3

Flare Male Reducing Adaptors

48-3-2	○	026613060460	3/16" OD Tube x 1/8" MIP	Rough	10	0.2
48-3-4	○	026613060477	3/16" OD Tube x 1/4" MIP	Rough	10	0.3
48-4-2	○	026613060484	1/4" OD Tube x 1/8" MIP	Rough	10	0.3
48-4-6	○	026613060507	1/4" OD Tube x 3/8" MIP	Rough	10	0.6
48-4-8	○	026613060521	1/4" OD Tube x 1/2" MIP	Rough	10	1.0
48-5-2	○	026613060545	5/16" OD Tube x 1/8" MIP	Rough	10	0.4
48-5-4	○	026613005355	5/16" OD Tube x 1/4" MIP	Rough	10	0.5
48-5-6	○	026613060552	5/16" OD Tube x 3/8" MIP	Rough	10	0.5
48-6-2	○	026613005362	3/8" OD Tube x 1/8" MIP	Rough	10	0.6
48-6-4	○	026613005379	3/8" OD Tube x 1/4" MIP	Rough	10	0.7
48-6-8	○	026613005393	3/8" OD Tube x 1/2" MIP	Rough	10	1.1
48-6-12	○	026613005409	3/8" OD Tube x 3/4" MIP	Rough	10	1.7
48-8-4	○	026613005416	1/2" OD Tube x 1/4" MIP	Rough	10	1.0
48-8-6	○	026613005423	1/2" OD Tube x 3/8" MIP	Rough	10	1.1
48-8-12	○	026613005447	1/2" OD Tube x 3/4" MIP	Rough	10	1.7
48-10-4	○	026613060415	5/8" OD Tube x 1/4" MIP	Rough	10	1.5
48-10-6	○	026613005454	5/8" OD Tube x 3/8" MIP	Rough	5	0.7
48-10-8	○	026613005461	5/8" OD Tube x 1/2" MIP	Rough	5	0.7
48-10-12	○	026613005478	5/8" OD Tube x 3/4" MIP	Rough	10	1.8
48-12-8	○	026613060439	3/4" OD Tube x 1/2" MIP	Rough	5	1.3
48-14-12	○	026613005485	7/8" OD Tube x 3/4" MIP	Rough	5	2.0



Flare Female Elbows

50-6-6	○	026613005584	3/8" OD Tube x 3/8" FIP	Rough	10	1.4
--------	---	--------------	-------------------------	-------	----	-----



Flare Female Reducing Elbows

50-6-8	○	026613005591	3/8" OD Tube x 1/2" FIP	Rough	10	2.1
50-10-8	○	026613005621	5/8" OD Tube x 1/2" FIP	Rough	5	1.6
50-10-12	○	026613005638	5/8" OD Tube x 3/4" FIP	Rough	5	1.9



Flare Male Elbows

49-4-4	○	026613005508	1/4" OD Tube x 1/4" MIP	Rough	10	0.7
49-6-6	○	026613005522	3/8" OD Tube x 3/8" MIP	Rough	10	1.4
49-8-8	○	026613005560	1/2" OD Tube x 1/2" MIP	Rough	10	2.4



Flare Male Reducing Elbows

49-3-2	○	026613063690	3/16" OD Tube x 1/8" MIP	Rough	10	0.4
49-4-2	○	026613005492	1/4" OD Tube x 1/8" MIP	Rough	10	0.5
49-4-6	○	026613063706	1/4" OD Tube x 3/8" MIP	Rough	10	0.8
49-5-2	○	026613063713	5/16" OD Tube x 1/8" MIP	Rough	10	0.5



○ Not for use in potable water applications.

PART NO.	USE	UPC	DESCRIPTION	FINISH	QTY	LBS
----------	-----	-----	-------------	--------	-----	-----

Flare Male Reducing Elbows (cont.)

49-5-4	○	026613063720	5/16" OD Tube x 1/4" MIP	Rough	10	0.7
49-6-2	○	026613063737	3/8" OD Tube x 1/8" MIP	Rough	10	1.2
49-6-4	○	026613005515	3/8" OD Tube x 1/4" MIP	Rough	10	1.0
49-6-8	○	026613005539	3/8" OD Tube x 1/2" MIP	Rough	10	1.9
49-8-4	○	026613005546	1/2" OD Tube x 1/4" MIP	Rough	10	1.7
49-8-6	○	026613005553	1/2" OD Tube x 3/8" MIP	Rough	10	1.8
49-10-8	○	026613005577	5/8" OD Tube x 1/2" MIP	Rough	5	1.2



Flare Union Elbows

55-3 B	○	026613065854	3/16" OD Tube, Both Ends	Rough	10	0.4
55-4	○	026613063898	1/4" OD Tube, Both Ends	Rough	10	0.5
55-6	○	026613005645	3/8" OD Tube, Both Ends	Rough	10	1.3
55-8	○	026613005652	1/2" OD Tube, Both Ends	Rough	10	2.0
55-10	○	026613005669	5/8" OD Tube, Both Ends	Rough	5	1.5



Flare Tees

44-3	○	026613063584	3/16" OD Tube, All 3 Ends	Rough	10	0.5
44-4	○	026613005126	1/4" OD Tube, All 3 Ends	Rough	10	0.7
44-5	○	026613063607	5/16" OD Tube, All 3 Ends	Rough	10	0.9
44-6	○	026613005133	3/8" OD Tube, All 3 Ends	Rough	10	1.7
44-8	○	026613005140	1/2" OD Tube, All 3 Ends	Rough	10	2.8
44-10	○	026613005157	5/8" OD Tube, All 3 Ends	Rough	5	1.9



Flare Reducing Tees

44-6-6-8	○	026613005164	3/8" OD Tube x 3/8" OD Tube x 1/2" OD Tube	Rough	10	2.2
44-8-6-6	○	026613063638	1/2" OD Tube x 3/8" OD Tube x 3/8" OD Tube	Rough	10	2.7
44-8-6-8	○	026613063645	1/2" OD Tube x 3/8" OD Tube x 1/2" OD Tube	Rough	10	2.7
44-8-8-6	○	026613005171	1/2" OD Tube x 1/2" OD Tube x 3/8" OD Tube	Rough	10	2.4
44-10-6-6	○	026613063560	5/8" OD Tube x 3/8" OD Tube x 3/8" OD Tube	Rough	10	2.7
44-10-10-8	○	026613063553	5/8" OD Tube x 5/8" OD Tube x 1/2" OD Tube	Rough	10	3.5



○ Not for use in potable water applications.

PART NO.	UPC	DESCRIPTION	FINISH	QTY	LBS
----------	-----	-------------	--------	-----	-----

Flare x FIP

AU1-6S	026613088501	3/8" OD Flare x 3/8" FIP, Steel	Rough	25	1.9
AU1-6-8S	026613106717	3/8" OD Flare x 1/2" FIP, Steel	Rough	25	2.8
AU1-8S	026613088532	1/2" OD Flare x 1/2" FIP, Steel	Rough	25	3.1
AU1-8-12S	026613088518	1/2" OD Flare x 3/4" FIP, Steel	Rough	25	3.3



AU1-14-12	026613132846	7/8" OD Flare x 3/4" FIP, Brass	Rough	10	1.8
AU1-14-16	026613132853	7/8" OD Flare x 1" FIP, Brass	Rough	10	2.9



MAU1-10-8S	026613088570	5/8" OD (15/16-16 Thread) Flare x 1/2" FIP, Steel	Rough	25	4.2
MAU1-10-12S	026613082660	5/8" OD (15/16-16 Thread) Flare x 3/4" FIP, Steel	Rough	25	4.7



MAE1-10-12	026613084213	5/8" OD (15/16-16 Thread) Flare x 3/4" FIP, Brass	Rough	25	8.1
------------	--------------	---	-------	----	-----

Flare x MIP

AU2-6S	026613088549	3/8" OD Flare x 3/8" MIP, Steel	Rough	25	2.5
AU2-6-8S	026613106724	3/8" OD Flare x 1/2" MIP (3/8" FIP), Steel	Rough	25	3.2
AU2-8S	026613082646	1/2" OD Flare x 1/2" MIP (3/8" FIP), Steel	Rough	25	3.5
AU2-8-6S	026613053707	1/2" OD Flare x 3/8" MIP, Steel	Rough	10	1.1
AU2-8-12S	026613088563	1/2" OD Flare x 3/4" MIP (1/2" FIP), Steel	Rough	25	7.2



AU2-14-12	026613132860	7/8" OD Flare x 3/4" MIP (1/2" FIP), Brass	Rough	10	2.6
AU2-14-16	026613132877	7/8" OD Flare x 1" MIP (3/4" FIP), Brass	Rough	10	4.2



MAU2-10-8S	026613082684	5/8" OD (15/16-16 Thread) Flare x 1/2" MIP, Steel	Rough	25	4.8
MAU2-10-12S	026613082677	5/8" OD (15/16-16 Thread) Flare x 3/4" MIP (1/2" FIP), Steel	Rough	25	6.2

Flare Caps

M40-10	026613052069	5/8" OD (15/16-16 Thread) Flare, Brass	Rough	10	1.0
--------	--------------	--	-------	----	-----

Gas Connector Nuts

ASN-10	026613082387	5/8" OD (15/16-16 Thread) Flare, Steel	Rough	25	2.7
--------	--------------	--	-------	----	-----

PART NO.	USE	UPC	DESCRIPTION	FINISH	QTY	LBS
----------	-----	-----	-------------	--------	-----	-----

Flare Refrigeration Nuts - Short

141S-4	●	026613005720	1/4" OD Tube	Rough	10	0.4
141S-5	●	026613058726	5/16" OD Tube	Rough	10	0.4
141S-6	●	026613005737	3/8" OD Tube	Rough	10	0.6
141S-8	●	026613005744	1/2" OD Tube	Rough	10	0.8
141S-10	●	026613005751	5/8" OD Tube	Rough	10	1.2
141S-12	●	026613005768	3/4" OD Tube	Rough	10	2.3
141S-14	●	026613058702	7/8" OD Tube	Rough	5	2.1



Flare Refrigeration Reducing Nuts - Short

141S-6-4	●	026613005775	3/8" OD Tube x 1/4" OD Tube	Rough	10	0.5
141S-8-6	●	026613005782	1/2" OD Tube x 3/8" OD Tube	Rough	10	0.8
141S-10-8	●	026613005799	5/8" OD Tube x 1/2" OD Tube	Rough	10	1.2



Flare Refrigeration Nuts - Long

141L-6 B	●	026613059235	3/8" OD Tube	Rough	10	28.1
141L-8	●	026613058696	1/2" OD Tube	Rough	10	1.1
141L-10	●	026613058634	5/8" OD Tube	Rough	10	2.0



Flare Female Elbows

150-4-4	○	026613063072	1/4" OD Tube x 1/4" FIP	Rough	10	2.5
150-6-6	○	026613063157	3/8" OD Tube x 3/8" FIP	Rough	10	1.0
150-8-8	○	026613063201	1/2" OD Tube x 1/2" FIP	Rough	10	2.5



Flare Female Reducing Elbows

150-4-2	○	026613063058	1/4" OD Tube x 1/8" FIP	Rough	10	0.8
150-4-6	○	026613063096	1/4" OD Tube x 3/8" FIP	Rough	10	0.8
150-5-4	○	026613063119	5/16" OD Tube x 1/4" FIP	Rough	10	0.8
150-6-4	○	026613063140	3/8" OD Tube x 1/4" FIP	Rough	10	0.8
150-6-8	○	026613063164	3/8" OD Tube x 1/2" FIP	Rough	10	1.3
150-6-12	○	026613063126	3/8" OD Tube x 3/4" FIP	Rough	10	1.5
150-8-6	○	026613063195	1/2" OD Tube x 3/8" FIP	Rough	10	1.2
150-8-12	○	026613063171	1/2" OD Tube x 3/4" FIP	Rough	10	2.1
150-10-6	○	026613063027	5/8" OD Tube x 3/8" FIP	Rough	10	2.1
150-10-8	○	026613082745	5/8" OD Tube x 1/2" FIP	Rough	10	2.3
150-10-12	○	026613063010	5/8" OD Tube x 3/4" MIP	Rough	10	2.3



Flare Male Elbows

149-2-2	○	026613062815	1/8" OD Tube x 1/8" MIP	Rough	10	0.3
149-4-4	○	026613062853	1/4" OD Tube x 1/4" MIP	Rough	10	0.5
149-6-6	○	026613062952	3/8" OD Tube x 3/8" MIP	Rough	10	1.3
149-8-8	○	026613063003	1/2" OD Tube x 1/2" MIP	Rough	10	1.4
149-12-12	○	026613064437	3/4" OD Tube x 3/4" MIP	Rough	25	9.8



Flare Male Reducing Elbows

149-3-2	○	026613062822	3/16" OD Tube x 1/8" MIP	Rough	10	0.4
149-4-2	○	026613062846	1/4" OD Tube x 1/8" MIP	Rough	10	0.4
149-4-6	○	026613062860	1/4" OD Tube x 3/8" MIP	Rough	10	0.7



- Not for use in potable water applications.
- Can be used in potable water applications.



PART NO.	USE	UPC	DESCRIPTION	FINISH	QTY	LBS
Flare Male Reducing Elbows (cont.)						
149-4-8	○	026613062877	1/4" OD Tube x 1/2" MIP	Rough	10	1.0
149-5-2	○	026613062884	5/16" OD Tube x 1/8" MIP	Rough	10	0.6
149-5-4	○	026613062891	5/16" OD Tube x 1/4" MIP	Rough	10	0.7
149-6-2	○	026613062938	3/8" OD Tube x 1/8" MIP	Rough	10	0.8
149-6-4	○	026613062945	3/8" OD Tube x 1/4" MIP	Rough	10	1.0
149-6-8	○	026613062969	3/8" OD Tube x 1/2" MIP	Rough	10	1.9
149-6-12	○	026613062921	3/8" OD Tube x 3/4" MIP	Rough	10	1.8
149-8-4	○	026613062983	1/2" OD Tube x 1/4" MIP	Rough	10	1.2
149-8-6	○	026613062990	1/2" OD Tube x 3/8" MIP	Rough	10	1.8
149-8-12	○	026613062976	1/2" OD Tube x 3/4" MIP	Rough	10	2.0
149-10-4	○	026613062778	5/8" OD Tube x 1/4" MIP	Rough	10	1.7
149-10-6	○	026613062785	5/8" OD Tube x 3/8" MIP	Rough	10	2.4
149-10-8	○	026613062792	5/8" OD Tube x 1/2" MIP	Rough	5	1.0
149-10-12	○	026613062761	5/8" OD Tube x 3/4" MIP	Rough	5	1.5
149-12-8	○	026613062808	3/4" OD Tube x 1/2" MIP	Rough	10	3.5



Flare Union Elbows						
155-4	○	026613063447	1/4" OD Tube, Both Ends	Rough	10	0.4
155-6	○	026613063461	3/8" OD Tube, Both Ends	Rough	10	0.9
155-8	○	026613005676	1/2" OD Tube, Both Ends	Rough	10	1.4
155-10	○	026613063386	5/8" OD Tube, Both Ends	Rough	10	2.1



Flare Reducing Union Elbows						
155-8-6	○	026613063485	1/2" OD Tube x 3/8" OD Tube	Rough	10	1.3
155-10-8	○	026613005683	5/8" OD Tube x 1/2" OD Tube	Rough	5	1.1



Flare 45° Male Elbows						
159-4-4	○	026613063515	1/4" OD Tube x 1/4" MIP	Rough	10	0.6
159-6-6	○	026613063539	3/8" OD Tube x 3/8" MIP	Rough	10	1.1



Flare 45° Male Reducing Elbows						
159-4-2	○	026613063508	1/4" OD Tube x 1/8" MIP	Rough	10	0.4
159-6-4	○	026613063522	3/8" OD Tube x 1/4" MIP	Rough	10	0.8
159-8-6	○	026613063546	1/2" OD Tube x 3/8" MIP	Rough	10	1.3
159-10-8	○	026613063492	5/8" OD Tube x 1/2" MIP	Rough	10	1.8



Swivel Flare Nut Connectors						
114FSV-4	●	026613058597	1/4" OD Tube, Both Ends	Rough	10	1.0
114FSV-5	●	026613058603	5/16" OD Tube, Both Ends	Rough	5	0.4
114FSV-6	●	026613058610	3/8" OD Tube, Both Ends	Rough	10	1.2
114FSV-8	●	026613058627	1/2" OD Tube, Both Ends	Rough	10	1.7
114FSV-10	●	026613058580	5/8" OD Tube, Both Ends	Rough	5	1.3

- Not for use in potable water applications.
 ● Can be used in potable water applications.

PART NO.	USE	UPC	DESCRIPTION	FINISH	QTY	LBS
Flare Tees						
144-4	○	026613062532	1/4" OD Tube, All 3 Ends	Rough	10	0.5
144-5	○	026613062556	5/16" OD Tube, All 3 Ends	Rough	10	0.9
144-6	○	026613062563	3/8" OD Tube, All 3 Ends	Rough	10	1.2
144-8	○	026613062594	1/2" OD Tube, All 3 Ends	Rough	10	1.9
144-10	○	026613062433	5/8" OD Tube, All 3 Ends	Rough	10	3.0



Flare Reducing Tees						
144-6-6-4	○	026613062587	3/8" OD Tube x 3/8" OD Tube x 1/4" OD Tube	Rough	10	1.0
144-8-6-6	○	026613062600	1/2" OD Tube x 3/8" OD Tube x 3/8" OD Tube	Rough	10	1.8
144-8-6-8	○	026613062617	1/2" OD Tube x 3/8" OD Tube x 1/2" OD Tube	Rough	10	1.8
144-8-8-6	○	026613007007	1/2" OD Tube x 1/2" OD Tube x 3/8" OD Tube	Rough	10	1.9
144-8-8-10	○	026613007014	1/2" OD Tube x 1/2" OD Tube x 5/8" OD Tube	Rough	5	1.4
144-10-10-6	○	026613062440	5/8" OD Tube x 5/8" OD Tube x 3/8" OD Tube	Rough	5	1.3
144-10-10-8	○	026613007021	5/8" OD Tube x 5/8" OD Tube x 1/2" OD Tube	Rough	5	1.4



Flare Female Reducing Tees (FIP on Branch)						
136-6-8	○	026613062402	3/8" OD Tube x 3/8" OD Tube x 1/2" FIP	Rough	10	1.9



Flare Male Tee Adaptors (MIP on Run)						
151-4-2	○	026613063232	1/4" OD Tube x 1/8" MIP x 1/4" OD Tube	Rough	10	1.0
151-4-4	○	026613063249	1/4" OD Tube x 1/4" MIP x 1/4" OD Tube	Rough	10	0.8
151-6-4	○	026613063287	3/8" OD Tube x 1/4" MIP x 3/8" OD Tube	Rough	10	1.1
151-6-6	○	026613063294	3/8" OD Tube x 3/8" MIP x 3/8" OD Tube	Rough	10	1.3
151-8-8	○	026613006956	1/2" OD Tube x 1/2" MIP x 1/2" OD Tube	Rough	10	2.3
151-10-8	○	026613063218	5/8" OD Tube x 1/2" MIP x 5/8" OD Tube	Rough	5	1.4



Flare Male Tee Adaptors (MIP on Branch)						
145-3-2	○	026613062662	3/16" OD Tube x 3/16" OD Tube x 1/8" MIP	Rough	10	0.5
145-4-2	○	026613062679	1/4" OD Tube x 1/4" OD Tube x 1/2" MIP	Rough	10	0.5
145-4-4	○	026613062686	1/4" OD Tube x 1/4" OD Tube x 1/4" MIP	Rough	10	0.7
145-6-4	○	026613062716	3/8" OD Tube x 3/8" OD Tube x 1/4" MIP	Rough	10	1.3
145-6-6	○	026613005805	3/8" OD Tube x 3/8" OD Tube x 3/8" MIP	Rough	10	1.3
145-6-8	○	026613062730	3/8" OD Tube x 3/8" OD Tube x 1/2" MIP	Rough	10	2.2
145-8-6	○	026613062747	1/2" OD Tube x 1/2" OD Tube x 3/8" MIP	Rough	10	1.8
145-8-8	○	026613005829	1/2" OD Tube x 1/2" OD Tube x 1/2" MIP	Rough	10	2.3
145-10-8	○	026613062631	5/8" OD Tube x 5/8" OD Tube x 1/2" MIP	Rough	5	1.4



Flare Cross Tees						
152-8	○	026613005843	1/2" OD Tube, All Ends	Rough	10	2.4



○ Not for use in potable water applications.



PART NO.	USE	UPC	DESCRIPTION	FINISH	QTY	LBS
Fine Thread Flare Caps						
FC-6	○	026613059037	3/8" OD Tube (9/16-24 Thread)	Rough	10	0.3



Fine Thread Flare Nuts						
F0-6	●	026613004785	3/8" OD Tube (9/16-24 Thread)	Rough	10	0.2
F0-6 C	●	026613059877	3/8" OD Tube (9/16-24 Thread)	Chrome	10	0.2
F0-8	●	026613967349	1/2" OD Tube (9/16-24 Thread)	Rough	10	0.4
F0-8 C	●	026613059884	1/2" OD Tube (9/16-24 Thread)	Chrome	10	0.4



Fine Thread Flare Reducing Nuts						
F0-6-4 R	●	026613058962	3/8" OD Tube (9/16-24 Thread) x 1/4" OD Tube	Rough	10	0.3
F0-6-4 C	●	026613059846	3/8" OD Tube (9/16-24 Thread) x 1/4" OD Tube	Chrome	10	0.3



Fine Thread Flare Unions						
FU3-6	○	026613005119	3/8" OD Tube (9/16-24 Thread), Both Ends	Rough	10	0.5



Fine Thread Flare Female Adaptors						
F10-6	○	026613004792	3/8" OD Tube (9/16-24 Thread) x 3/8" FIP	Rough	10	0.5
F12-6-8	○	026613004808	3/8" OD Tube (9/16-24 Thread) x 1/2" FIP	Rough	10	0.7



Fine Thread Flare Male Adaptors						
FRC11-6	○	026613004761	3/8" OD Tube (9/16-24 Thread) x 3/8" MIP (Tapped 1/8" FIP)	Rough	10	0.6
FRC13-6-8	○	026613004778	3/8" OD Tube (9/16-24 Thread) x 1/2" MIP (Tapped 3/8" FIP)	Rough	10	0.8



Fine Thread Flare Male Elbows						
FRC16-6	○	026613064031	3/8" OD Tube (9/16-24 Thread) x 3/8" MIP	Rough	10	1.0
FRC18-6-8	○	026613064048	3/8" OD Tube (9/16-24 Thread) x 1/2" MIP	Rough	10	1.3



Fine Thread Flare Tees						
FT3-6	○	026613064055	3/8" OD Tube (9/16-24 Thread), All 3 Ends	Rough	10	1.4

- Not for use in potable water applications.
 ● Can be used in potable water applications.

Brass Compression Fittings

Product Applications

- For use with potable water, instrumentation, hydraulic and pneumatic systems.
- Designed to be used with aluminum, copper and plastic tubing. Not recommended for steel tubing. Plastic tubing requires 63PT insert and 60PT sleeve.

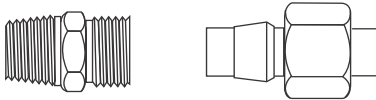

WARNING: Do not use compression fittings for gas connections of any kind.

Product Advantages

- BrassCraft® Compression Fittings do not require any flaring, soldering or other type of tubing preparation.
- Available in a broad range of sizes and styles.
- Manufactured from brass rod.
- Backed by BrassCraft Mfg.'s 65 plus year history and reputation for quality and service.

Working Pressure Ranges

- Operating temperatures and tubing type are important factors. The following table (73° F temperature with copper tubing) is a good guide to use for proper selection.

PSI	Tube OD (IN)	Tube Wall (IN)
400	1/8	.030
400	3/16	.030
300	1/4	.030
300	5/16	.032
200	3/8	.032
200	1/2	.032
150	5/8	.035
100	3/4	.035
75	7/8	.035

How to Order

- Ordered as complete assemblies (body, nut, sleeve). Nuts and sleeves can also be ordered separately by part number.

Special Orders

- Special fitting configurations and sizes may be ordered. Please furnish a print or sketch of your needs with your inquiry.
- Fittings are available in bulk quantities on request. Contact your sales representative for details.



Assembly Instructions

1. For use with type L or M copper only. A drop of oil or thread sealant will make tightening easier. If using a drop of oil or thread sealant, be sure that threads are clean of any debris and that sealant is also free of any metal debris. DO NOT USE a "PUTTY" or gasket type material.
2. Cut tubing to required length.
3. Slide nut and then sleeve onto tubing. Threaded end of nut must face toward fitting.
4. Insert tubing into fitting body, making sure tubing is bottomed on fitting shoulder.
5. Assemble nut to fitting body, hand tighten.
6. Tighten with a wrench 1/2 turn after nut begins to take hold or bite.

PEX Tube Compression Connection

For PEX Tube 3/8" OD and smaller, use plastic compression sleeve.

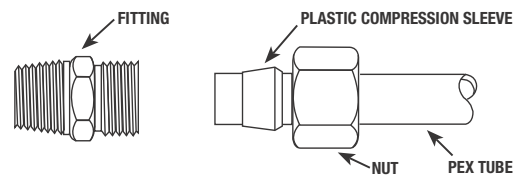

For PEX Tube larger than 3/8" OD, use brass compression sleeve with stainless steel tube insert.

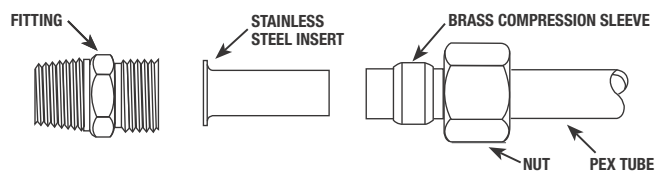

PART NO.	USE	UPC	DESCRIPTION	FINISH	QTY	LBS
Compression Plugs						
CSP-4	○	026613066257	For 1/4" OD Tube	Rough	10	.05
CSP-4X	▲	026613149486	For 1/4" OD Tube	Rough	10	.05
CSP-6	○	026613066271	For 3/8" OD Tube	Rough	10	0.1
CSP-6X	▲	026613149509	For 3/8" OD Tube	Rough	10	0.1
CSP-8	○	026613066288	For 1/2" OD Tube	Rough	10	0.2
CSP-8X	▲	026613149523	For 1/2" OD Tube	Rough	10	0.2
CSP-10	○	026613066240	For 5/8" OD Tube	Rough	10	0.2
CSP-10X	▲	026613149479	For 5/8" OD Tube	Rough	10	0.2



Compression Sleeves

60-2	●	026613005904	For 1/8" OD Tube	Brass	10	.01
60-3	●	026613005911	For 3/16" OD Tube	Brass	10	.02
60-4	●	026613005928	For 1/4" OD Tube	Brass	10	.02
60-5	●	026613005935	For 5/16" OD Tube	Brass	10	.04
60-6	●	026613005942	For 3/8" OD Tube	Brass	10	.03
60-7	●	026613005959	For 7/16" OD Tube	Brass	10	.05
60-8	●	026613005966	For 1/2" OD Tube	Brass	10	0.1
60-10	●	026613005973	For 5/8" OD Tube	Brass	5	.03
60-12	●	026613066059	For 3/4" OD Tube	Brass	5	0.1
60-14	●	026613005980	For 7/8" OD Tube	Brass	5	0.1



Compression Caps

61CP-4	○	026613024561	1/4" OD Tube	Rough	10	0.1
61CP-4X	▲	026613154411	1/4" OD Tube	Rough	10	0.1
61CP-6	○	026613024578	3/8" OD Tube	Rough	10	0.2
61CP-6X	▲	026613154428	3/8" OD Tube	Rough	10	0.2
61CP-8	○	026613024585	1/2" OD Tube	Rough	10	0.4
61CP-8X	▲	026613154435	1/2" OD Tube	Rough	10	0.4
61CP-10	○	026613024592	5/8" OD Tube	Rough	10	0.4
61CP-10X	▲	026613154404	5/8" OD Tube	Rough	10	0.6



Compression Nuts

61-2	●	026613066073	1/8" OD Tube	Rough	10	0.1
61-3	●	026613006048	3/16" OD Tube	Rough	10	0.1
61-4	●	026613006055	1/4" OD Tube	Rough	10	0.1
61-5	●	026613006062	5/16" OD Tube	Rough	10	0.2
61-6	●	026613006079	3/8" OD Tube	Rough	10	0.2
61-7	●	026613066080	7/16" OD Tube	Rough	10	0.2
61-8	●	026613006086	1/2" OD Tube	Rough	10	0.4
61-10	●	026613006093	5/8" OD Tube	Rough	5	0.2
61-12	●	026613066066	3/4" OD Tube	Rough	10	0.8
61-14	●	026613006109	7/8" OD Tube	Rough	5	0.4



○ Not for use in potable water applications.

● Can be used in potable water applications.

▲ Certified Compliant to NSF/ANSI 372 for potable water applications

PART NO.	USE	UPC	DESCRIPTION	FINISH	QTY	LBS
Compression Nuts - Long						
61L-4	●	026613006116	1/4" OD Tube	Rough	10	0.2
61L-6	●	026613006123	3/8" OD Tube	Rough	10	0.4
61L-12	●	026613066202	3/4" OD Tube	Rough	5	1.0



Compression Unions						
62-2	○	026613006147	1/8" OD Tube, Both Ends	Rough	10	0.3
62-3	○	026613006154	3/16" OD Tube, Both Ends	Rough	10	0.4
62-4	○	026613006161	1/4" OD Tube, Both Ends	Rough	10	0.5
62-4X	▲	026613135403	1/4" OD Tube, Both Ends	Rough	10	0.5
62-4DT	○	026613068756	1/4" OD Tube, Drill Through (No Tube Stop), Both Ends	Rough	50	2.4
62-4DTX	▲	026613147833	1/4" OD Tube, Drill Through (No Tube Stop), Both Ends	Rough	50	2.4
62-5	○	026613006178	5/16" OD Tube, Both Ends	Rough	10	0.7
62-6	○	026613006185	3/8" OD Tube, Both Ends	Rough	10	0.7
62-6X	▲	026613136899	3/8" OD Tube, Both Ends	Rough	10	0.7
62-6X C	▲	026613147888	3/8" OD Tube, Both Ends	Chrome	10	0.7
62-6DT	○	026613067308	3/8" OD Tube, Drill Through (No Tube Stop), Both Ends	Rough	25	1.7
62-6DTX	▲	026613147871	3/8" OD Tube, Drill Through (No Tube Stop), Both Ends	Rough	25	1.7
62-7	○	026613067315	7/16" OD Tube, Both Ends	Rough	10	0.9
62-8	○	026613006192	1/2" OD Tube, Both Ends	Rough	10	1.3
62-8X	▲	026613136905	1/2" OD Tube, Both Ends	Rough	10	1.3
62-8DT	○	026613067322	1/2" OD Tube, Drill Through (No Tube Stop), Both Ends	Rough	25	3.1
62-10	○	026613006208	5/8" OD Tube, Both Ends	Rough	10	1.8
62-10X	▲	026613136783	5/8" OD Tube, Both Ends	Rough	10	1.8
62-10DT	○	026613067230	5/8" OD Tube, Drill Through (No Tube Stop), Both Ends	Rough	10	1.6
62-10DTX	▲	026613147802	5/8" OD Tube, Drill Through (No Tube Stop), Both Ends	Rough	10	1.6
62-12	○	026613006215	3/4" OD Tube, Both Ends	Rough	10	3.5
62-14	○	026613006222	7/8" OD Tube, Both Ends	Rough	10	3.2
62-14X	▲	026613136806	7/8" OD Tube, Both Ends	Rough	10	3.2
62-14DT	○	026613067254	7/8" OD Tube, Drill Through (No Tube Stop), Both Ends	Rough	10	3.2



Compression Reducing Unions						
62-4-2	○	026613067261	1/4" OD Tube x 1/8" OD Tube	Rough	10	0.7
62-4-3	○	026613067278	1/4" OD Tube x 3/16" OD Tube	Rough	10	0.8
62-5-4	○	026613067285	5/16" OD Tube x 1/4" OD Tube	Rough	10	0.9
62-6-4	○	026613006239	3/8" OD Tube x 1/4" OD Tube	Rough	10	0.7
62-6-4X	▲	026613135427	3/8" OD Tube x 1/4" OD Tube	Rough	10	0.7
62-6-5	○	026613067292	3/8" OD Tube x 5/16" OD Tube	Rough	10	0.7
62-8-6	○	026613006246	1/2" OD Tube x 3/8" OD Tube	Rough	10	1.1
62-8-6 C	○	026613069029	1/2" OD Tube x 3/8" OD Tube	Chrome	10	1.1



- Not for use in potable water applications.
- Can be used in potable water applications.
- ▲ Certified Compliant to NSF/ANSI 372 for potable water applications



PART NO.	USE	UPC	DESCRIPTION	FINISH	QTY	LBS
Compression Reducing Unions (cont.)						
62-8-6X	▲	026613136912	1/2" OD Tube x 3/8" OD Tube	Rough	10	1.1
62-10-6	○	026613006253	5/8" OD Tube x 3/8" OD Tube	Rough	10	1.4
62-10-6X	▲	026613136776	5/8" OD Tube x 3/8" OD Tube	Rough	10	1.4
62-10-8	○	026613006260	5/8" OD Tube x 1/2" OD Tube	Rough	5	0.8
62-10-8X	▲	026613147772	5/8" OD Tube x 1/2" OD Tube	Rough	5	0.8



Compression Female Adaptors

66-12-12	○	026613067568	3/4" OD Tube x 3/4" FIP	Rough	10	2.5
66-2-2	○	026613067582	1/8" OD Tube x 1/8" FIP	Rough	10	0.3
66-4-4	○	026613006437	1/4" OD Tube x 1/4" FIP	Rough	10	0.6
66-4-4X	▲	026613136226	1/4" OD Tube x 1/4" FIP	Rough	10	0.6
66-6-6	○	026613006475	3/8" OD Tube x 3/8" FIP	Rough	10	0.6
66-6-6X	▲	026613136202	3/8" OD Tube x 3/8" FIP	Rough	10	0.6
66-8-8	○	026613006505	1/2" OD Tube x 1/2" FIP	Rough	10	0.9
66-8-8X	▲	026613148274	1/2" OD Tube x 1/2" FIP	Rough	10	0.9



Compression Female Reducing Adaptors

66-3-2	○	026613006406	3/16" OD Tube x 1/8" FIP	Rough	10	0.4
66-3-4	○	026613006413	3/16" OD Tube x 1/4" FIP	Rough	10	0.6
66-4-2	○	026613006420	1/4" OD Tube x 1/8" FIP	Rough	10	0.4
66-4-2X	▲	026613148168	1/4" OD Tube x 1/8" FIP	Rough	10	0.3
66-4-6	○	026613067599	1/4" OD Tube x 3/8" FIP	Rough	10	0.7
66-4-6X	▲	026613148199	1/4" OD Tube x 3/8" FIP	Rough	10	0.7
66-4-8	○	026613067605	1/4" OD Tube x 1/2" FIP	Rough	10	0.8
66-4-8X	▲	026613148205	1/4" OD Tube x 1/2" FIP	Rough	10	0.8
66-5-4	○	026613006451	5/16" OD Tube x 1/4" FIP	Rough	10	0.6
66-5-6	○	026613067612	5/16" OD Tube x 3/8" FIP	Rough	10	0.8
66-6-12	○	026613067629	3/8" OD Tube x 3/4" FIP	Rough	25	3.7
66-6-2	○	026613067636	3/8" OD Tube x 1/8" FIP	Rough	10	0.5
66-6-2X	▲	026613137681	3/8" OD Tube x 1/8" FIP	Rough	10	0.5
66-6-4	○	026613006468	3/8" OD Tube x 1/4" FIP	Rough	10	0.6
66-6-4X	▲	026613148212	3/8" OD Tube x 1/4" FIP	Rough	10	0.6
66-6-8	○	026613006499	3/8" OD Tube x 1/2" FIP	Rough	10	0.7
66-6-8X	▲	026613136189	3/8" OD Tube x 1/2" FIP	Rough	10	0.7
66-6-8 C	○	026613067650	3/8" OD Tube x 1/2" FIP	Chrome	10	0.7
66-6-8X C	▲	026613148236	3/8" OD Tube x 1/2" FIP	Chrome	10	0.7
66-8-12	○	026613068336	1/2" OD Tube x 3/4" FIP	Rough	25	4.3
66-8-4	○	026613067667	1/2" OD Tube x 1/4" FIP	Rough	10	1.0
66-8-6	○	026613006482	1/2" OD Tube x 3/8" FIP	Rough	10	0.8
66-8-6X	▲	026613148250	1/2" OD Tube x 3/8" FIP	Rough	10	0.8
66-10-6	○	026613006512	5/8" OD Tube x 3/8" FIP	Rough	5	0.6
66-10-6X	▲	026613148120	5/8" OD Tube x 3/8" FIP	Rough	5	0.6
66-10-8	○	026613006529	5/8" OD Tube x 1/2" FIP	Rough	5	0.7
66-10-8X	▲	026613135441	5/8" OD Tube x 1/2" FIP	Rough	5	0.7
66-10-12	○	026613006536	5/8" OD Tube x 3/4" FIP	Rough	5	0.8

○ Not for use in potable water applications.

▲ Certified Compliant to NSF/ANSI 372 for potable water applications

PART NO.	USE	UPC	DESCRIPTION	FINISH	QTY	LBS
Compression Female Reducing Adaptors (cont.)						
66-10-12X	▲	026613148113	5/8" OD Tube x 3/4" FIP	Rough	5	0.8
66-12-8	○	026613067575	3/4" OD Tube x 1/2" FIP	Rough	5	1.3
66-14-12	○	026613006543	7/8" OD Tube x 3/4" FIP	Rough	5	1.4
66-14-12X	▲	026613148144	7/8" OD Tube x 3/4" FIP	Rough	5	1.4



Compression Male Adaptors						
68-2-2	○	026613006550	1/8" OD Tube x 1/8" MIP	Rough	10	0.3
68-4-4	○	026613006598	1/4" OD Tube x 1/4" MIP	Rough	10	0.4
68-4-4X	▲	026613136639	1/4" OD Tube x 1/4" MIP	Rough	10	0.4
68-6-6	○	026613006642	3/8" OD Tube x 3/8" MIP	Rough	10	0.7
68-6-6X	▲	026613136646	3/8" OD Tube x 3/8" MIP	Rough	10	0.7
68-6-6X C	▲	026613139043	3/8" OD Tube x 3/8" MIP	Chrome	10	0.7
68-8-8	○	026613006673	1/2" OD Tube x 1/2" MIP	Rough	10	1.2
68-8-8X	▲	026613135380	1/2" OD Tube x 1/2" MIP	Rough	10	1.2
68-8DT	○	026613054155	1/2" OD Tube, Drill Through (No Tube Stop) x 1/2" MIP	Rough	25	3.0
68-8DTX	▲	026613148649	1/2" OD Tube, Drill Through (No Tube Stop) x 1/2" MIP	Rough	25	3.0
68-12-12	○	026613067858	3/4" OD Tube x 3/4" MIP	Rough	10	2.5



Compression Male Reducing Adaptors						
68-3-2	○	026613006567	3/16" OD Tube x 1/8" MIP	Rough	10	0.3
68-3-4	○	026613006574	3/16" OD Tube x 1/4" MIP	Rough	10	0.6
68-4-2	○	026613006581	1/4" OD Tube x 1/8" MIP	Rough	10	0.4
68-4-2X	▲	026613135533	1/4" OD Tube x 1/8" MIP	Rough	10	0.4
68-4-6	○	026613067919	1/4" OD Tube x 3/8" MIP	Rough	10	0.7
68-4-6X	▲	026613136585	1/4" OD Tube x 3/8" MIP	Rough	10	0.7
68-4-8	○	026613067926	1/4" OD Tube x 1/2" MIP	Rough	10	1.0
68-4-8X	▲	026613136608	1/4" OD Tube x 1/2" MIP	Rough	10	1.0
68-5-2	○	026613006604	5/16" OD Tube x 1/8" MIP	Rough	10	0.5
68-5-4	○	026613006611	5/16" OD Tube x 1/4" MIP	Rough	10	0.6
68-5-6	○	026613067940	5/16" OD Tube x 3/8" MIP	Rough	10	0.5
68-6-2	○	026613006628	3/8" OD Tube x 1/8" MIP	Rough	10	0.5
68-6-2X	▲	026613135564	3/8" OD Tube x 1/8" MIP	Rough	10	0.5
68-6-4	○	026613006635	3/8" OD Tube x 1/4" MIP	Rough	10	0.6
68-6-4X	▲	026613135526	3/8" OD Tube x 1/4" MIP	Rough	10	0.6
68-6-4X C	▲	026613148526	3/8" OD Tube x 1/4" MIP	Chrome	10	0.6
68-6-8	○	026613006659	3/8" OD Tube x 1/2" MIP	Rough	10	0.9
68-6-8X	▲	026613136615	3/8" OD Tube x 1/2" MIP	Rough	10	0.9
68-6-8X C	▲	026613139036	3/8" OD Tube x 1/2" MIP	chrome	10	0.9
13X R	▲	026613136257	3/8" OD Tube, Drill Through (No Tube Stop) x 1/2" MIP	Rough	25	2.3
13X C	▲	026613136264	3/8" OD Tube, Drill Through (No Tube Stop) x 1/2" MIP	Chrome	25	2.3
68-6-12	○	026613067957	3/8" OD Tube x 3/4" MIP	Rough	10	2.0
68-6-12X	▲	026613148489	3/8" OD Tube x 3/4" MIP	Rough	10	2.0



○ Not for use in potable water applications.
 ▲ Certified Compliant to NSF/ANSI 372 for potable water applications

PART NO.	USE	UPC	DESCRIPTION	FINISH	QTY	LBS
Compression Male Reducing Adaptors (cont.)						
68-7-4	○	026613067964	7/16" OD Tube x 1/4" MIP	Rough	10	0.7
68-7-4X	▲	026613148557	7/16" OD Tube x 1/4" MIP	Rough	10	0.7
68-7-6	○	026613067971	7/16" OD Tube x 3/8" MIP	Rough	10	0.7
68-8-4	○	026613067995	1/2" OD Tube x 1/4" MIP	Rough	10	1.0
68-8-4X	▲	026613148588	1/2" OD Tube x 1/4" MIP	Rough	10	1.0
68-8-6	○	026613006666	1/2" OD Tube x 3/8" MIP	Rough	10	0.9
68-8-6X	▲	026613136592	1/2" OD Tube x 3/8" MIP	Rough	10	0.8
68-8-12	○	026613067988	1/2" OD Tube x 3/4" MIP	Rough	10	1.8
68-8-12X	▲	026613148564	1/2" OD Tube x 3/4" MIP	Rough	10	1.6
68-10-6	○	026613067841	5/8" OD Tube x 3/8" MIP	Rough	10	1.3
68-10-8	○	026613006680	5/8" OD Tube x 1/2" MIP	Rough	10	1.3
68-10-8X	▲	026613136622	5/8" OD Tube x 1/2" MIP	Rough	10	1.3
68-10-12	○	026613006697	5/8" OD Tube x 3/4" MIP	Rough	10	1.7
68-10-12X	▲	026613135557	5/8" OD Tube x 3/4" MIP	Rough	10	1.7
68-12-8	○	026613067865	3/4" OD Tube x 1/2" MIP	Rough	10	2.5
68-14-8	○	026613067889	7/8" OD Tube x 1/2" MIP	Rough	10	2.3
68-14-8X	▲	026613148328	7/8" OD Tube x 1/2" MIP	Rough	10	2.3
68-14-12	○	026613006703	7/8" OD Tube x 3/4" MIP	Rough	10	2.3
68-14-12X	▲	026613135366	7/8" OD Tube x 3/4" MIP	Rough	10	2.3
68-14-16	○	026613067872	7/8" OD Tube x 1" MIP	Rough	5	1.6
68-14-16X	▲	026613148311	7/8" OD Tube x 1" MIP	Rough	5	1.6



Compression Union Elbows

65-2	○	026613071022	1/8" OD Tube, Both Ends	Rough	10	0.3
65-3	○	026613006345	3/16" OD Tube, Both Ends	Rough	10	0.5
65-4	○	026613006352	1/4" OD Tube, Both Ends	Rough	10	0.7
65-4X	▲	026613148076	1/4" OD Tube, Both Ends	Rough	10	0.7
65-5	○	026613006369	5/16" OD Tube, Both Ends	Rough	10	0.9
65-6	○	026613006376	3/8" OD Tube, Both Ends	Rough	10	1.1
65-6X	▲	026613136394	3/8" OD Tube, Both Ends	Rough	10	1.1
65-6 C	○	026613071046	3/8" OD Tube, Both Ends	Chrome	10	1.1
65-8	○	026613006383	1/2" OD Tube, Both Ends	Rough	10	2.0
65-8X	▲	026613148106	1/2" OD Tube, Both Ends	Rough	10	2.4
65-10	○	026613006390	5/8" OD Tube, Both Ends	Rough	10	2.9
65-10X	▲	026613136301	5/8" OD Tube, Both Ends	Rough	10	3.0
65-14	○	026613072210	7/8" OD Tube, Both Ends	Rough	5	2.2
65-14X	▲	026613148069	7/8" OD Tube, Both Ends	Rough	5	2.2



Compression Reducing Union Elbows

65-8-6	○	026613967714	1/2" OD Tube x 3/8" OD Tube	Rough	10	1.5
65-10-6	○	026613070971	5/8" OD Tube x 3/8" OD Tube	Rough	10	1.8
65-10-6 C	○	026613070988	5/8" OD Tube x 3/8" OD Tube	Chrome	10	1.8
65-10-6X	▲	026613148045	5/8" OD Tube x 3/8" OD Tube	Rough	10	1.8
65-10-6X C	▲	026613148052	5/8" OD Tube x 3/8" OD Tube	Chrome	10	1.8
65-10-8	○	026613070995	5/8" OD Tube x 1/2" OD Tube	Rough	10	2.1



○ Not for use in potable water applications.

▲ Certified Compliant to NSF/ANSI 372 for potable water applications

PART NO.	USE	UPC	DESCRIPTION	FINISH	QTY	LBS
Compression Female Elbows						
70-2-2	○	026613071435	1/8" OD Tube x 1/8" FIP	Rough	5	0.3
70-4-4	○	026613071466	1/4" OD Tube x 1/4" FIP	Rough	10	0.8
70-4-4X	▲	026613148779	1/4" OD Tube x 1/4" FIP	Rough	10	0.8
70-6-6	○	026613071510	3/8" OD Tube x 3/8" FIP	Rough	10	1.0
70-6-6X	▲	026613148793	3/8" OD Tube x 3/8" FIP	Rough	10	1.4
70-6-6 C	○	026613066233	3/8" OD Tube x 3/8" FIP	Chrome	10	1.0
70-8-8	○	026613071565	1/2" OD Tube x 1/2" FIP	Rough	10	1.7
70-8-8 C	○	026613054193	1/2" OD Tube x 1/2" FIP	Chrome	25	4.4



Compression Female Reducing Elbows						
70-3-2	○	026613071442	3/16" OD Tube x 1/8" FIP	Rough	5	0.3
70-4-2	○	026613071459	1/4" OD Tube x 1/8" FIP	Rough	10	0.7
70-4-2X	▲	026613148762	1/4" OD Tube x 1/8" FIP	Rough	10	0.7
70-4-8	○	026613074023	1/4" OD Tube x 1/2" FIP	Rough	10	1.2
70-5-2	○	026613071473	5/16" OD Tube x 1/8" FIP	Rough	10	0.8
70-5-2X	▲	026613137759	5/16" OD Tube x 1/8" FIP	Rough	10	1.1
70-5-4	○	026613071480	5/16" OD Tube x 1/4" FIP	Rough	5	0.5
70-6-2	○	026613071497	3/8" OD Tube x 1/8" FIP	Rough	10	0.8
70-6-4	○	026613071503	3/8" OD Tube x 1/4" FIP	Rough	10	0.9
70-6-4X	▲	026613148786	3/8" OD Tube x 1/4" FIP	Rough	10	0.9
70-6-8	○	026613071527	3/8" OD Tube x 1/2" FIP	Rough	10	1.3
70-6-8X	▲	026613148809	3/8" OD Tube x 1/2" FIP	Rough	10	1.3
70-6-8 C	○	026613054179	3/8" OD Tube x 1/2" FIP	Chrome	10	1.3
70-6-8X C	▲	026613148816	3/8" OD Tube x 1/2" FIP	Chrome	10	1.3
70-8-6	○	026613071558	1/2" OD Tube x 3/8" FIP	Rough	10	1.5
70-10-8	○	026613071428	5/8" OD Tube x 1/2" FIP	Rough	10	2.6
70-10-8X	▲	026613136370	5/8" OD Tube x 1/2" FIP	Rough	10	2.6
70-10-12	○	026613073941	5/8" OD Tube x 3/4" FIP	Rough	10	2.2



Compression Female 90° Drop-Ear Elbows						
38C-10-8	○	026613070933	5/8" OD Tube x 1/2" FIP	Rough	10	4.3



Compression Male Elbows						
69-2-2	○	026613071077	1/8" OD Tube x 1/8" MIP	Rough	10	0.4
69-2-2X	▲	026613152882	1/8" OD Tube x 1/8" MIP	Rough	10	0.4
69-4-4	○	026613006734	1/4" OD Tube x 1/4" MIP	Rough	10	0.7
69-4-4X	▲	026613136424	1/4" OD Tube x 1/4" MIP	Rough	10	0.7
69-6-6	○	026613006765	3/8" OD Tube x 3/8" MIP	Rough	10	1.1
69-6-6X	▲	026613136325	3/8" OD Tube x 3/8" MIP	Rough	10	1.1
69-6-6 C	○	026613073507	3/8" OD Tube x 3/8" MIP	Chrome	10	1.1
69-6-6X C	▲	026613148700	3/8" OD Tube x 3/8" MIP	Chrome	10	1.1
69-8-8	○	026613006796	1/2" OD Tube x 1/2" MIP	Rough	10	1.8
69-8-8X	▲	026613148748	1/2" OD Tube x 1/2" MIP	Rough	10	1.8



○ Not for use in potable water applications.
 ▲ Certified Compliant to NSF/ANSI 372 for potable water applications



PART NO.	USE	UPC	DESCRIPTION	FINISH	QTY	LBS
----------	-----	-----	-------------	--------	-----	-----

Compression Male Elbows (cont.)

69-8-8 C	○	026613071220	1/2" OD Tube x 1/2" MIP	Chrome	10	1.8
----------	---	--------------	-------------------------	--------	----	-----

Compression Male Reducing Elbows

69-3-2	○	026613006710	3/16" OD Tube x 1/8" MIP	Rough	10	0.5
69-3-4	○	026613071084	3/16" OD Tube x 1/4" MIP	Rough	10	0.5
69-4-2	○	026613006727	1/4" OD Tube x 1/8" MIP	Rough	10	0.5
69-4-2X	▲	026613136431	1/4" OD Tube x 1/8" MIP	Rough	10	0.5
69-4-6	○	026613071107	1/4" OD Tube x 3/8" MIP	Rough	10	1.2
69-4-6X	▲	026613148663	1/4" OD Tube x 3/8" MIP	Rough	10	1.2
69-5-2	○	026613006741	5/16" OD Tube x 1/8" MIP	Rough	10	0.7
69-5-4	○	026613071114	5/16" OD Tube x 1/4" MIP	Rough	10	0.7
69-5-6	○	026613071121	5/16" OD Tube x 3/8" MIP	Rough	10	0.7
69-5-8	○	026613071138	5/16" OD Tube x 1/2" MIP	Rough	10	1.2
69-6-2	○	026613071152	3/8" OD Tube x 1/8" MIP	Rough	10	0.8
69-6-2X	▲	026613136455	3/8" OD Tube x 1/8" MIP	Rough	10	0.8
69-6-4	○	026613006758	3/8" OD Tube x 1/4" MIP	Rough	10	0.9
69-6-4X	▲	026613136349	3/8" OD Tube x 1/4" MIP	Rough	10	0.9
69-6-4 C	○	026613071176	3/8" OD Tube x 1/4" MIP	Chrome	10	0.9
69-6-8	○	026613006772	3/8" OD Tube x 1/2" MIP	Rough	10	1.4
69-6-8X	▲	026613136479	3/8" OD Tube x 1/2" MIP	Rough	10	1.5
69-6-8 C	○	026613072241	3/8" OD Tube x 1/2" MIP	Chrome	10	1.4
69-6-8X C	▲	026613148717	3/8" OD Tube x 1/2" MIP	Chrome	10	1.4
69-6-12	○	026613071145	3/8" OD Tube x 3/4" MIP	Rough	5	0.8
69-7-4	○	026613071183	7/16" OD Tube x 1/4" MIP	Rough	5	0.6
69-7-6	○	026613071190	7/16" OD Tube x 3/8" MIP	Rough	10	1.1
69-8-4	○	026613071206	1/2" OD Tube x 1/4" MIP	Rough	10	0.8
69-8-4X	▲	026613148724	1/2" OD Tube x 1/4" MIP	Rough	10	0.8
69-8-6	○	026613006789	1/2" OD Tube x 3/8" MIP	Rough	10	1.5
69-8-6X	▲	026613136493	1/2" OD Tube x 3/8" MIP	Rough	10	1.4
69-8-6 C	○	026613071213	1/2" OD Tube x 3/8" MIP	Chrome	10	1.5
69-8-6X C	▲	026613148731	1/2" OD Tube x 3/8" MIP	Chrome	10	1.4
69-10-6	○	026613006802	5/8" OD Tube x 3/8" MIP	Rough	5	1.0
69-10-8	○	026613006819	5/8" OD Tube x 1/2" MIP	Rough	5	1.5
69-10-8X	▲	026613136516	5/8" OD Tube x 1/2" MIP	Rough	5	1.4
69-10-12	○	026613006826	5/8" OD Tube x 3/4" MIP	Rough	5	1.3
69-14-12	○	026613073095	7/8" OD Tube x 3/4" MIP	Rough	10	3.4



Compression Tees

64-2	○	026613070940	1/8" OD Tube, All 3 Ends	Rough	10	0.6
64-3	○	026613006277	3/16" OD Tube, All 3 Ends	Rough	10	0.7
64-4	○	026613006284	1/4" OD Tube, All 3 Ends	Rough	10	1.0
64-4X	▲	026613136684	1/4" OD Tube, All 3 Ends	Rough	10	1.1



○ Not for use in potable water applications.

▲ Certified Compliant to NSF/ANSI 372 for potable water applications

PART NO.	USE	UPC	DESCRIPTION	FINISH	QTY	LBS
Compression Tees (cont.)						
64-5	○	026613006291	5/16" OD Tube, All 3 Ends	Rough	10	1.3
64-6	○	026613006307	3/8" OD Tube, All 3 Ends	Rough	10	1.5
64-6X	▲	026613136660	3/8" OD Tube, All 3 Ends	Rough	10	1.5
64-6X C	▲	026613147994	3/8" OD Tube, All 3 Ends	Chrome	10	1.5
64-8	○	026613006314	1/2" OD Tube, All 3 Ends	Rough	10	2.6
64-8X	▲	026613148038	1/2" OD Tube, All 3 Ends	Rough	10	3.0
64-10	○	026613006321	5/8" OD Tube, All 3 Ends	Rough	10	3.7
64-10X	▲	026613135311	5/8" OD Tube, All 3 Ends	Rough	10	3.8



Compression Reducing Tees						
64-6-6-4	○	026613004075	3/8" OD Tube x 3/8" OD Tube x 1/4" OD Tube	Rough	10	1.3
64-6-6-4X	▲	026613148014	3/8" OD Tube x 3/8" OD Tube x 1/4" OD Tube	Rough	10	1.3
64-8-8-6	○	026613006338	1/2" OD Tube x 1/2" OD Tube x 3/8" OD Tube	Rough	10	2.1



Compression Female Tee Adaptors (FIP on Branch)						
CT1-662	○	026613072173	3/8" OD Tube x 3/8" OD Tube x 1/8" FIP	Rough	10	1.0
CT2-664X P	▲	026613140933	3/8" OD Tube x 3/8" OD Tube x 1/4" Female Comp Nut	Rough	10	1.9
CT2-666X P	▲	026613140926	3/8" OD Tube x 3/8" OD Tube x 3/8" Female Comp Nut	Rough	10	1.9



Compression Male Tee Adaptors (MIP on Run)						
71-4-2	○	026613071749	1/4" OD Tube x 1/8" MIP x 1/4" OD Tube	Rough	10	0.8
71-4-2X	▲	026613148854	1/4" OD Tube x 1/8" MIP x 1/4" OD Tube	Rough	10	0.9
71-4-4	○	026613071756	1/4" OD Tube x 1/4" MIP x 1/4" OD Tube	Rough	5	0.5
71-6-4	○	026613071794	3/8" OD Tube x 1/4" MIP x 3/8" OD Tube	Rough	10	1.1
71-6-4X	▲	026613148861	3/8" OD Tube x 1/4" MIP x 3/8" OD Tube	Rough	10	1.1
71-6-6	○	026613071800	3/8" OD Tube x 3/8" MIP x 3/8" OD Tube	Rough	10	1.3



Compression Male Tee Adaptors (MIP on Branch)						
72-2-2	○	026613071954	1/8" OD Tube x 1/8" OD Tube x 1/8" MIP	Rough	10	0.6
72-3-2	○	026613071961	3/16" OD Tube x 3/16" OD Tube x 1/8" MIP	Rough	10	0.6
72-4-2	○	026613071978	1/4" OD Tube x 1/4" OD Tube x 1/8" MIP	Rough	10	0.7
72-4-2X	▲	026613148878	1/4" OD Tube x 1/4" OD Tube x 1/8" MIP	Rough	10	0.7
72-4-4	○	026613071985	1/4" OD Tube x 1/4" OD Tube x 1/4" MIP	Rough	10	0.9
72-4-4X	▲	026613148885	1/4" OD Tube x 1/4" OD Tube x 1/4" MIP	Rough	10	0.9
72-5-2	○	026613071992	5/16" OD Tube x 5/16" OD Tube x 1/8" MIP	Rough	10	1.1
72-6-2	○	026613072012	3/8" OD Tube x 3/8" OD Tube x 1/8" MIP	Rough	10	1.1
72-6-4	○	026613072029	3/8" OD Tube x 3/8" OD Tube x 1/4" MIP	Rough	10	1.3
72-6-6	○	026613072036	3/8" OD Tube x 3/8" OD Tube x 3/8" MIP	Rough	10	2.3
72-6-6X	▲	026613148892	3/8" OD Tube x 3/8" OD Tube x 3/8" MIP	Rough	10	1.6
72-8-6	○	026613072043	1/2" OD Tube x 1/2" OD Tube x 3/8" MIP	Rough	10	2.1
72-8-8	○	026613072050	1/2" OD Tube x 1/2" OD Tube x 1/2" MIP	Rough	10	3.0
72-10-8	○	026613071947	5/8" OD Tube x 5/8" OD Tube x 1/2" MIP	Rough	5	1.4



○ Not for use in potable water applications.
 ▲ Certified Compliant to NSF/ANSI 372 for potable water applications



PART NO.	USE	UPC	DESCRIPTION	FINISH	QTY	LBS
Compression Bulkhead Unions						
62BH-4	○	026613067339	1/4" OD Tube, Both Ends	Rough	10	1.0
62BH-6	○	026613067346	3/8" OD Tube, Both Ends	Rough	10	1.5



PART NO.	USE	UPC	DESCRIPTION	FINISH	QTY	LBS
Flare Compression Adaptors						
462-6-4	○	026613100708	3/8" Female Flare x 1/4" OD Tube	Rough	10	0.6
462-6-4X	▲	026613154381	3/8" Female Flare x 1/4" OD Tube	Rough	10	0.6
462-6-6	○	026613100692	3/8" Female Flare x 3/8" OD Tube	Rough	10	0.7
462-6-6X	▲	026613154398	3/8" Female Flare x 3/8" OD Tube	Rough	10	0.7
462-8-6	○	026613100685	1/2" Female Flare x 3/8" OD Tube	Rough	10	0.7
462-8-6X	▲	026613155494	1/2" Female Flare x 3/8" OD Tube	Rough	10	0.5



PART NO.	USE	UPC	DESCRIPTION	FINISH	QTY	LBS
Sweat Compression Unions						
24 R	○	026613054537	1/2" Nom Sweat x 1/4" OD Tube	Rough	25	1.4
24X R	▲	026613147697	1/2" Nom Sweat x 1/4" OD Tube	Rough	25	1.2



PART NO.	USE	UPC	DESCRIPTION	FINISH	QTY	LBS
Sweat Compression Adaptors						
14 R	○	026613054483	1/2" Nom Sweat x 3/8" OD Tube, Drill Through (No Tube Stop)	Rough	25	1.4
14X R	▲	026613140698	1/2" Nom Sweat x 3/8" OD Tube, Drill Through (No Tube Stop)	Rough	25	1.4
14 C	○	026613054476	1/2" Nom Sweat x 3/8" OD Tube	Chrome	25	1.6
14X C	▲	026613146850	1/2" Nom Sweat x 3/8" OD Tube, Drill Through (No Tube Stop)	Chrome	25	1.4



PART NO.	USE	UPC	DESCRIPTION	FINISH	QTY	LBS
Sweat Compression Elbows						
19 R	○	026613054506	1/2" Nom Sweat x 3/8" OD Tube	Rough	25	2.9
19 C	○	026613054490	1/2" Nom Sweat x 3/8" OD Tube	Chrome	25	2.9
19X C	▲	026613146904	1/2" Nom Sweat x 3/8" OD Tube	Chrome	25	2.9



PART NO.	USE	UPC	DESCRIPTION	FINISH	QTY	LBS
Compression Female Adaptors						
10 R	○	026613053691	3/8" OD Tube, Drill Through (No Tube Stop) x 3/8" FIP	Rough	25	1.5
10 C	○	026613053684	3/8" OD Tube, Drill Through (No Tube Stop) x 3/8" FIP	Chrome	25	1.5
10X C	▲	026613145266	3/8" OD Tube, Drill Through (No Tube Stop) x 3/8" FIP	Chrome	25	1.5
32 C	○	026613053974	1/2" OD Tube, Drill Through (No Tube Stop) x 1/2" FIP	Chrome	10	0.9



PART NO.	USE	UPC	DESCRIPTION	FINISH	QTY	LBS
Compression Male Adaptors						
11 R	○	026613053806	3/8" OD Tube, Drill Through (No Tube Stop) x 3/8" MIP	Rough	25	1.7
11X R	▲	026613145297	3/8" OD Tube, Drill Through (No Tube Stop) x 3/8" MIP	Rough	25	1.7
11 C	○	026613053790	3/8" OD Tube, Drill Through (No Tube Stop) x 3/8" MIP	Chrome	25	1.7
11X C	▲	026613136172	3/8" OD Tube, Drill Through (No Tube Stop) x 3/8" MIP	Chrome	25	1.7
33 C	○	026613053998	1/2" OD Tube, Drill Through (No Tube Stop) x 1/2" MIP	Chrome	25	3.0

○ Not for use in potable water applications.

▲ Certified Compliant to NSF/ANSI 372 for potable water applications

PART NO.	USE	UPC	DESCRIPTION	FINISH	QTY	LBS
----------	-----	-----	-------------	--------	-----	-----

Compression Male Adaptors (cont.)

33X C	▲	026613147703	1/2" OD Tube, Drill Through (No Tube Stop) x 1/2" MIP	Chrome	25	3.0
-------	---	--------------	---	--------	----	-----



Compression Female Reducing Adaptors

12 R	○	026613053820	3/8" OD Tube, Drill Through (No Tube Stop) x 1/2" FIP	Rough	25	1.8
12X R	▲	026613146188	3/8" OD Tube, Drill Through (No Tube Stop) x 1/2" FIP	Rough	25	1.8
12 C	○	026613053813	3/8" OD Tube, Drill Through (No Tube Stop) x 1/2" FIP	Chrome	25	1.8
12X C	▲	026613146171	3/8" OD Tube, Drill Through (No Tube Stop) x 1/2" FIP	Chrome	25	1.8



Sweat Compression Adaptors

30 C	○	026613053936	1/2" OD Tube, Drill Through (No Tube Stop) x 3/8" FIP	Chrome	25	2.0
34 R	○	026613054551	1/2" Nom Sweat x 1/2" OD Tube, Drill Through (No Tube Stop)	Rough	25	2.0
34 C	○	026613054544	1/2" Nom Sweat x 1/2" OD Tube, Drill Through (No Tube Stop)	Chrome	25	2.1



Compression Reducing Unions

C14 R	○	026613054681	5/8" OD Tube x 3/8" OD Tube, Drill Through (No Tube Stop)	Rough	10	1.4
C14 C	○	026613054674	5/8" OD Tube x 3/8" OD Tube, Drill Through (No Tube Stop)	Chrome	25	3.4
C14X C	▲	026613149066	5/8" OD Tube x 3/8" OD Tube, Drill Through (No Tube Stop)	Chrome	25	3.4
C34 R	○	026613054728	5/8" OD Tube x 1/2" OD Tube, Drill Through (No Tube Stop)	Rough	10	1.5
C34 C	○	026613054711	5/8" OD Tube x 1/2" OD Tube, Drill Through (No Tube Stop)	Chrome	25	3.9



○ Not for use in potable water applications.

▲ Certified Compliant to NSF/ANSI 372 for potable water applications



PART NO.	USE	UPC	DESCRIPTION	FINISH	QTY	LBS
Compression Sleeves for Plastic Tube						
60PT-4	▲	026613005997	For 1/4" OD Tube	Plastic	10	.01
60PT-5	▲	026613006000	For 5/16" OD Tube	Plastic	10	.02
60PT-6	▲	026613006017	For 3/8" OD Tube	Plastic	10	.01
60PT-8	▲	026613006024	For 1/2" OD Tube	Plastic	10	.02
60PT-10	▲	026613006031	For 5/8" OD Tube	Plastic	10	.02



PART NO.	USE	UPC	DESCRIPTION	FINISH	QTY	LBS
Brass Inserts for Nylon & Plastic Hose						
63PT-4X	▲	026613152868	For 1/4" OD Tube	Brass	10	.02
63PT-5X	▲	026613158006	For 5/16" OD Tube	Brass	10	.02
63PT-6X	▲	026613152875	For 3/8" OD Tube	Brass	10	.03
63PT-8X	▲	026613147956	For 1/2" OD Tube	Brass	10	.05
63PT-10X	▲	026613152851	For 5/8" OD Tube	Brass	10	0.1



PART NO.	USE	UPC	DESCRIPTION	FINISH	QTY	LBS
Compression Sleeves for Plastic Tube						
TS-6X	▲	026613107110	For 3/8" Nom Tube	Steel	10	0.1
TS-8X	▲	026613097541	For 1/2" Nom Tube	Steel	10	0.1



PART NO.	USE	UPC	DESCRIPTION	FINISH	QTY	LBS
Compression Nut with Captive Brass Sleeves						
61CA-2	●	026613066134	1/8" OD Tube	Rough	10	0.1
61CA-3 B	●	026613066981	3/16" OD Tube	Rough	10	4.3
61CA-4	●	026613066158	1/4" OD Tube	Rough	10	0.1
61CA-5	●	026613066165	5/16" OD Tube	Rough	10	0.2
61CA-6	●	026613066172	3/8" OD Tube	Rough	10	0.2
61CA-8	●	026613066189	1/2" OD Tube	Rough	10	0.4



PART NO.	USE	UPC	DESCRIPTION	FINISH	QTY	LBS
Compression Union with Captive Sleeves						
62CA-4	○	026613079363	1/4" OD Tube, Both Ends	Rough	10	0.5



PART NO.	USE	UPC	DESCRIPTION	FINISH	QTY	LBS
Compression Male Reducing Elbow with Captive Sleeves						
69CA-4-2	○	026613079691	1/4" OD Tube x 1/8" MIP	Rough	10	0.5



PART NO.	USE	UPC	DESCRIPTION	FINISH	QTY	LBS
Compression Male Adaptor with Captive Sleeves						
68CA-4-2	○	026613079622	1/4" OD Tube x 1/8" MIP	Rough	10	0.3
68CA-4-4	○	026613079639	1/4" OD Tube x 1/4" MIP	Rough	10	0.4

○ Not for use in potable water applications.

● Can be used in potable water applications.

▲ Certified Compliant to NSF/ANSI 372 for potable water applications

PART NO.	USE	UPC	DESCRIPTION	FINISH	QTY	LBS
CPVC Compression Reducing Adaptors						
P14C C	○	026613054759	1/2" Nom CPVC x 3/8" OD Tube	Chrome	10	1.5
P14C R	○	026613054766	1/2" Nom CPVC x 3/8" OD Tube	Rough	10	1.5
P14CX R	▲	026613154497	1/2" Nom CPVC x 3/8" OD Tube	Rough	10	1.5
P44C R	○	026613054797	1/2" Nom CPVC x 5/8" OD Tube	Rough	10	1.9
P44CX R	▲	026613154503	1/2" Nom CPVC x 5/8" OD Tube	Rough	10	1.9
P77C R	○	026613054889	1/2" Nom CPVC x 7/8" OD Tube	Rough	10	4.2



CPVC Compression Reducing Elbow						
P19C C	○	026613054773	1/2" Nom CPVC x 3/8" OD Tube	Chrome	10	1.9



CPVC Female Adaptors						
P48F R	○	026613054810	1/2" Nom CPVC x 1/2" FIP	Rough	10	1.6
P48FX R	▲	026613154510	1/2" Nom CPVC x 1/2" FIP	Rough	10	1.6
P72F R	○	026613054865	3/4" Nom CPVC x 3/4" FIP	Rough	10	3.7
P72FX R	▲	026613150932	3/4" Nom CPVC x 3/4" FIP	Rough	10	3.7



CPVC Female 90° Drop-Ear Elbows						
P48W R	○	026613054841	1/2" Nom CPVC x 1/2" FIP	Rough	10	4.4
P48WX R	▲	026613150925	1/2" Nom CPVC x 1/2" FIP	Rough	10	4.4



CPVC Male Adaptors						
P48M C	○	026613054827	1/2" Nom CPVC x 1/2" MIP	Chrome	10	1.4
P48M R	○	026613054834	1/2" Nom CPVC x 1/2" MIP	Rough	10	1.4
P48MX R	▲	026613150918	1/2" Nom CPVC x 1/2" MIP	Rough	10	1.4
P72M R	○	026613054872	3/4" Nom CPVC x 3/4" MIP	Rough	10	3.3
P72MX R	▲	026613150949	3/4" Nom CPVC x 3/4" MIP	Rough	10	3.3



○ Not for use in potable water applications.
 ▲ Certified Compliant to NSF/ANSI 372 for potable water applications

Iron Pipe Fittings

Product Applications

- For use with brass, copper or iron pipe.
- Designed for low and medium pressure pipe line connections.
- Typically used in water, grease, fuels, LP and natural gas, refrigeration, instrumentation and hydraulic systems.

Product Advantages

- All pipe fitting threads meet the standards developed by the Society of Automotive Engineers (SAE).
- Connectors, unions, nuts and extruded elbows and tees machined from brass rod.
- Forged elbows and tees machined from brass.
- Backed by BrassCraft Mfg.'s 65 plus year history and reputation for quality and service.

How to Order

- Order fittings by part number and product name.
- To order with pre-applied pipe sealant, add a "V" suffix to part number.
Example: 202-6V.
"V" fittings special order only.

Special Orders

- Special fitting configurations and sizes may be ordered. Please furnish a print or sketch of your needs with your inquiry.
- Fittings are available in bulk quantities on request. Contact your sales representative for details.



PART NO.	USE	UPC	DESCRIPTION	FINISH	QTY	LBS
----------	-----	-----	-------------	--------	-----	-----

Hex Countersink Pipe Plugs



219-2X	▲	026613147451	1/8" MIP	Rough	10	0.1
219-4X	▲	026613147475	1/4" MIP	Rough	10	0.2
219-6X	▲	026613147482	3/8" MIP	Rough	10	0.3
219-8X	▲	026613147499	1/2" MIP	Rough	10	0.7

Hex Head Pipe Plugs



PPH-2	○	026613006901	1/8" MIP	Rough	10	0.2
PPH-2X	▲	026613151137	1/8" MIP	Rough	10	0.2
PPH-4	○	026613006918	1/4" MIP	Rough	10	0.4
PPH-4X	▲	026613151151	1/4" MIP	Rough	10	0.4
PPH-6	○	026613006925	3/8" MIP	Rough	10	0.6
PPH-6X	▲	026613151175	3/8" MIP	Rough	10	0.6
PPH-8	○	026613006932	1/2" MIP	Rough	10	1.1
PPH-8X	▲	026613151199	1/2" MIP	Rough	10	1.1
PPH-12	○	026613076058	3/4" MIP	Rough	10	1.4

Square Head Pipe Plugs



211-2	○	026613003979	1/8" MIP	Rough	10	0.2
211-2X	▲	026613147369	1/8" MIP	Rough	10	0.2
211-4	○	026613003986	1/4" MIP	Rough	10	0.4
211-4X	▲	026613147376	1/4" MIP	Rough	10	0.4
211-6	○	026613003993	3/8" MIP	Rough	10	0.6
211-6X	▲	026613147383	3/8" MIP	Rough	10	0.6
211-8	○	026613004006	1/2" MIP	Rough	10	1.2
211-8X	▲	026613147390	1/2" MIP	Rough	10	1.2
211-12	○	026613004457	3/4" MIP	Rough	10	1.2

○ Not for use in potable water applications.

▲ Certified Compliant to NSF/ANSI 372 for potable water applications

PART NO.	USE	UPC	DESCRIPTION	FINISH	QTY	LBS
Pipe Caps						
213-2	○	026613004013	1/8" FIP	Rough	10	0.2
213-2X	▲	026613147406	1/8" FIP	Rough	10	0.2
213-4	○	026613004020	1/4" FIP	Rough	10	0.4
213-6	○	026613004037	3/8" FIP	Rough	10	0.6
213-6X	▲	026613147413	3/8" FIP	Rough	10	0.6
213-8	○	026613004464	1/2" FIP	Rough	10	0.8
213-12	○	026613004471	3/4" FIP	Rough	10	1.6



Pipe Locknuts						
210-2	●	026613075730	1/8" FIP	Rough	10	0.2
210-4	●	026613075747	1/4" FIP	Rough	10	0.3
210-6	●	026613075754	3/8" FIP	Rough	10	0.4
210-8	●	026613075761	1/2" FIP	Rough	10	0.4



Female Pipe Unions						
104-4	○	026613074733	1/4" FIP, Both Ends	Rough	10	1.8
104-6	○	026613074740	3/8" FIP, Both Ends	Rough	10	2.3
104-8	○	026613074757	1/2" FIP, Both Ends	Rough	10	4.2
104-12	○	026613074719	3/4" FIP, Both Ends	Rough	5	2.3



Female Pipe Couplings						
207-2	○	026613003931	1/8" FIP, Both Ends	Rough	10	0.3
207-2X	▲	026613147284	1/8" FIP, Both Ends	Rough	10	0.3
207-4	○	026613003948	1/4" FIP, Both Ends	Rough	10	0.9
207-4X	▲	026613147307	1/4" FIP, Both Ends	Rough	10	0.9
207-6	○	026613003955	3/8" FIP, Both Ends	Rough	10	1.0
207-6X	▲	026613147321	3/8" FIP, Both Ends	Rough	10	0.8
207-8	○	026613003962	1/2" FIP, Both Ends	Rough	10	2.0
207-8X	▲	026613147345	1/2" FIP, Both Ends	Rough	10	2.0
207-12	○	026613004440	3/4" FIP, Both Ends	Rough	10	2.3
207-12X	▲	026613147260	3/4" FIP, Both Ends	Rough	10	2.3



Pipe Reducer Couplings						
119-4-2	○	026613010526	1/4" FIP x 1/8" FIP	Rough	10	0.8
119-6-2	○	026613075501	3/8" FIP x 1/8" FIP	Rough	10	0.6
119-6-4	○	026613010540	3/8" FIP x 1/4" FIP	Rough	10	1.2
119-6-4X	▲	026613146140	3/8" FIP x 1/4" FIP	Rough	10	1.2
119-8-2	○	026613075518	1/2" FIP x 1/8" FIP	Rough	10	1.0
119-8-4	○	026613075525	1/2" FIP x 1/4" FIP	Rough	10	1.9
119-8-4X	▲	026613146157	1/2" FIP x 1/4" FIP	Rough	10	1.9
119-8-6	○	026613010557	1/2" FIP x 3/8" FIP	Rough	10	2.0
119-8-6X	▲	026613146164	1/2" FIP x 3/8" FIP	Rough	10	1.0
119-12-8	○	026613010533	3/4" FIP x 1/2" FIP	Rough	10	1.8
119-12-8X	▲	026613146133	3/4" FIP x 1/2" FIP	Rough	10	1.8



- Not for use in potable water applications.
- Can be used in potable water applications.
- ▲ Certified Compliant to NSF/ANSI 372 for potable water applications

PART NO.	USE	UPC	DESCRIPTION	FINISH	QTY	LBS
Pipe Adaptors						
120-2	○	026613075563	1/8" FIP x 1/8" MIP	Rough	25	0.6
120-2X	▲	026613146201	1/8" FIP x 1/8" MIP	Rough	25	0.6
120-4	○	026613075570	1/4" FIP x 1/4" MIP	Rough	25	2.4
120-4X	▲	026613146218	1/4" FIP x 1/4" MIP	Rough	25	2.4
120-4-2	○	026613075587	1/4" FIP x 1/8" MIP	Rough	25	1.9
120-4-2X	▲	026613146225	1/4" FIP x 1/8" MIP	Rough	25	1.9
120-6	○	026613075594	3/8" FIP x 3/8" MIP	Rough	25	2.8
120-6-2	○	026613075600	3/8" FIP x 1/8" MIP	Rough	25	2.3
120-6-2X	▲	026613146232	3/8" FIP x 1/8" MIP	Rough	25	2.3
120-6-4	○	026613075617	3/8" FIP x 1/4" MIP	Rough	25	2.5
120-8	○	026613075624	1/2" FIP x 1/2" MIP	Rough	25	2.6
120-8X	▲	026613146249	1/2" FIP x 1/2" MIP	Rough	25	2.6
120-8-4	○	026613075631	1/2" FIP x 1/4" MIP	Rough	10	1.5
120-8-4X	▲	026613146256	1/2" FIP x 1/4" MIP	Rough	10	1.8
120-8-6	○	026613075648	1/2" FIP x 3/8" MIP	Rough	25	3.3
120-8-6X	▲	026613146270	1/2" FIP x 3/8" MIP	Rough	25	3.3
120-12	○	026613075532	3/4" FIP x 3/4" MIP	Rough	10	3.7
120-12-6	○	026613075549	3/4" FIP x 3/8" MIP	Rough	10	3.0
120-12-8	○	026613075556	3/4" FIP x 1/2" MIP	Rough	10	3.5
120-12-8X	▲	026613146195	3/4" FIP x 1/2" MIP	Rough	10	3.5



Pipe Reducer Bushings

PRB-4-2	○	026613004112	1/4" MIP x 1/8" FIP	Rough	10	0.2
PRB-4-2X	▲	026613151304	1/4" MIP x 1/8" FIP	Rough	10	0.2
PRB-6-2	○	026613076102	3/8" MIP x 1/8" FIP	Rough	10	0.5
PRB-6-2X	▲	026613151328	3/8" MIP x 1/8" FIP	Rough	10	0.5
PRB-6-4	○	026613004129	3/8" MIP x 1/4" FIP	Rough	10	0.4
PRB-6-4X	▲	026613151342	3/8" MIP x 1/4" FIP	Rough	10	0.4
PRB-8-2	○	026613076119	1/2" MIP x 1/8" FIP	Rough	10	1.3
PRB-8-2X	▲	026613151366	1/2" MIP x 1/8" FIP	Rough	10	1.3
PRB-8-4	○	026613076126	1/2" MIP x 1/4" FIP	Rough	10	1.1
PRB-8-4X	▲	026613151373	1/2" MIP x 1/4" FIP	Rough	10	1.1
PRB-8-6	○	026613004136	1/2" MIP x 3/8" FIP	Rough	10	0.7
PRB-8-6X	▲	026613151397	1/2" MIP x 3/8" FIP	Rough	10	0.7
PRB-12-2	○	026613076065	3/4" MIP x 1/8" FIP	Rough	10	2.3
PRB-12-4	○	026613076072	3/4" MIP x 1/4" FIP	Rough	10	2.1
PRB-12-4X	▲	026613151267	3/4" MIP x 1/4" FIP	Rough	10	2.1
PRB-12-6	○	026613076089	3/4" MIP x 3/8" FIP	Rough	10	1.7
PRB-12-8	○	026613004105	3/4" MIP x 1/2" FIP	Rough	5	0.6
PRB-12-8X	▲	026613151281	3/4" MIP x 1/2" FIP	Rough	5	0.6
PRB-16-12	○	026613967028	1" MIP x 3/4" FIP	Rough	5	1.0



○ Not for use in potable water applications.

▲ Certified Compliant to NSF/ANSI 372 for potable water applications

PART NO.	USE	UPC	DESCRIPTION	FINISH	QTY	LBS
----------	-----	-----	-------------	--------	-----	-----

Male Pipe Sweat Adaptors (Converts Female Pipe to Sweat Joint)

PSA-8	○	026613076157	1/2" MIP x 1/2" Nom Sweat	Rough	10	0.3
PSA-8X	▲	039166120444	1/2" MIP x 1/2" Nom Sweat	Rough	10	0.3
PSA-12	○	026613076133	3/4" MIP x 3/4" Nom Sweat	Rough	10	0.3
PSA-12X	▲	039166120420	3/4" MIP x 3/4" Nom Sweat	Rough	10	0.3
PSA-16	○	026613076140	1" MIP x 1" Nom Sweat	Rough	10	0.7
PSA-16X	▲	039166120437	1" MIP x 1" Nom Sweat	Rough	10	0.7



90° Female Pipe Elbows

200-2	○	026613003849	1/8" FIP, Both Ends	Rough	10	0.7
200-2X	▲	026613146911	1/8" FIP, Both Ends	Rough	10	0.7
200-4	○	026613003856	1/4" FIP, Both Ends	Rough	10	1.2
200-4X	▲	026613146942	1/4" FIP, Both Ends	Rough	10	1.2
200-6	○	026613003863	3/8" FIP, Both Ends	Rough	10	1.4
200-6X	▲	026613146966	3/8" FIP, Both Ends	Rough	10	1.8
200-8	○	026613004426	1/2" FIP, Both Ends	Rough	10	2.7
200-8X	▲	026613146997	1/2" FIP, Both Ends	Rough	10	2.7
200-12	○	026613004433	3/4" FIP, Both Ends	Rough	10	4.0



90° Street Elbows

202-2	○	026613006888	1/8" FIP x 1/8" MIP	Rough	10	0.5
202-2X	▲	026613147031	1/8" FIP x 1/8" MIP	Rough	10	0.5
202-4	○	026613006895	1/4" FIP x 1/4" MIP	Rough	10	1.1
202-4X	▲	026613147062	1/4" FIP x 1/4" MIP	Rough	10	1.1
202-6	○	026613012315	3/8" FIP x 3/8" MIP	Rough	10	1.7
202-6X	▲	026613147093	3/8" FIP x 3/8" MIP	Rough	10	1.6
202-8	○	026613012322	1/2" FIP x 1/2" MIP	Rough	10	3.1
202-8X	▲	026613147123	1/2" FIP x 1/2" MIP	Rough	10	3.1
202-12	○	026613075679	3/4" FIP x 3/4" MIP	Rough	10	2.4
202-12X	▲	026613147024	3/4" FIP x 3/4" MIP	Rough	10	2.4



45° Female Pipe Elbows

205-2	○	026613075693	1/8" FIP, Both Ends	Rough	10	0.6
205-4	○	026613075709	1/4" FIP, Both Ends	Rough	10	1.2
205-6	○	026613075716	3/8" FIP, Both Ends	Rough	10	1.4
205-8	○	026613075723	1/2" FIP, Both Ends	Rough	10	2.3
205-12	○	026613075686	3/4" FIP, Both Ends	Rough	10	3.1



45° Street Elbows

224-2	○	026613075860	1/8" FIP x 1/8" MIP	Rough	10	0.4
224-2X	▲	026613147512	1/8" FIP x 1/8" MIP	Rough	10	0.4
224-4	○	026613075877	1/4" FIP x 1/4" MIP	Rough	10	0.9
224-4X	▲	026613147529	1/4" FIP x 1/4" MIP	Rough	10	0.9
224-6	○	026613075884	3/8" FIP x 3/8" MIP	Rough	10	1.1
224-6X	▲	026613147536	3/8" FIP x 3/8" MIP	Rough	10	1.1
224-8	○	026613075891	1/2" FIP x 1/2" MIP	Rough	10	2.2



○ Not for use in potable water applications.

▲ Certified Compliant to NSF/ANSI 372 for potable water applications



PART NO.	USE	UPC	DESCRIPTION	FINISH	QTY	LBS
45° Street Elbows (cont.)						
224-8X	▲	026613147543	1/2" FIP x 1/2" MIP	Rough	10	2.2

Close Pipe Nipples



112-02-RX	▲	026613145303	1/8" MIP, Both Ends	Rough	25	0.3
112-04-RX	▲	026613145310	1/4" MIP, Both Ends	Rough	25	0.6
112-06-CX	▲	026613145327	3/8" MIP, Both Ends	Chrome	25	1.2
112-06-RX	▲	026613145334	3/8" MIP, Both Ends	Rough	25	0.9
112-08-CX	▲	026613145341	1/2" MIP, Both Ends	Chrome	5	0.4
112-08-RX	▲	026613145358	1/2" MIP, Both Ends	Rough	5	0.4
112-12-RX	▲	026613145365	3/4" MIP, Both Ends	Rough	5	0.6
112-16-RX	▲	026613145372	1" MIP, Both Ends	Rough	5	0.8

Hex Pipe Nipples



PHN-2	○	026613004082	1/8" MIP, Both Ends	Rough	10	0.3
PHN-2X	▲	026613150970	1/8" MIP, Both Ends	Rough	10	0.3
PHN-4	○	026613004273	1/4" MIP, Both Ends	Rough	10	0.5
PHN-4X	▲	026613150994	1/4" MIP, Both Ends	Rough	10	0.5
PHN-4-2	○	026613076003	1/4" MIP x 1/8" MIP	Rough	10	0.5
PHN-4-2X	▲	026613151014	1/4" MIP x 1/8" MIP	Rough	10	0.5
PHN-6	○	026613004099	3/8" MIP, Both Ends	Rough	10	0.8
PHN-6X	▲	026613151038	3/8" MIP, Both Ends	Rough	10	0.8
PHN-6-2	○	026613076010	3/8" MIP x 1/8" MIP	Rough	10	0.7
PHN-6-4	○	026613076027	3/8" MIP x 1/4" MIP	Rough	10	0.8
PHN-8	○	026613004334	1/2" MIP, Both Ends	Rough	10	1.4
PHN-8X	▲	026613151076	1/2" MIP, Both Ends	Rough	10	1.3
PHN-8-4	○	026613076034	1/2" MIP x 1/4" MIP	Rough	10	1.2
PHN-8-4X	▲	026613151090	1/2" MIP x 1/4" MIP	Rough	10	1.2
PHN-8-6	○	026613076041	1/2" MIP x 3/8" MIP	Rough	10	1.2
PHN-8-6X	▲	026613151113	1/2" MIP x 3/8" MIP	Rough	10	1.2
PHN-12	○	026613075990	3/4" MIP x 3/4" MIP	Rough	10	2.0
PHN-12X	▲	026613150956	3/4" MIP x 3/4" MIP	Rough	10	2.0

Pipe Nipples



113-02-1.5-RX	▲	026613145402	1/8" MIP x 1-1/2"	Rough	25	0.8
113-02-2-RX	▲	026613145426	1/8" MIP x 2"	Rough	25	1.0
113-02-2.5-RX	▲	026613145419	1/8" MIP x 2-1/2"	Rough	25	1.2
113-02-3-RX	▲	026613145440	1/8" MIP x 3"	Rough	25	1.5
113-02-3.5-RX	▲	026613145433	1/8" MIP x 3-1/2"	Rough	25	2.0
113-02-4-RX	▲	026613145457	1/8" MIP x 4"	Rough	25	2.2
113-04-1.5-RX	▲	026613145464	1/4" MIP x 1-1/2"	Rough	25	1.5
113-04-2-RX	▲	026613145488	1/4" MIP x 2"	Rough	25	1.8
113-04-2.5-RX	▲	026613145471	1/4" MIP x 2-1/2"	Rough	25	1.9
113-04-3-RX	▲	026613145501	1/4" MIP x 3"	Rough	25	3.0
113-04-3.5-RX	▲	026613145495	1/4" MIP x 3-1/2"	Rough	25	2.8

○ Not for use in potable water applications.

▲ Certified Compliant to NSF/ANSI 372 for potable water applications

PART NO.	USE	UPC	DESCRIPTION	FINISH	QTY	LBS
Pipe Nipples (cont.)						
113-04-4-RX	▲	026613145518	1/4" MIP x 4"	Rough	25	3.9
113-04-6-RX	▲	026613145525	1/4" MIP x 6"	Rough	25	5.2
113-06-1.5-RX	▲	026613145549	3/8" MIP x 1-1/2"	Rough	25	1.6
113-06-1.5-CX	▲	026613145532	3/8" MIP x 1-1/2"	Chrome	25	1.6
113-06-2-RX	▲	026613145587	3/8" MIP x 2"	Rough	25	2.5
113-06-2-CX	▲	026613145570	3/8" MIP x 2"	Chrome	25	2.3
113-06-2.5-RX	▲	026613145563	3/8" MIP x 2-1/2"	Rough	25	2.5
113-06-2.5-CX	▲	026613145556	3/8" MIP x 2-1/2"	Chrome	25	2.4
113-06-3-RX	▲	026613145617	3/8" MIP x 3"	Rough	25	3.8
113-06-3-CX	▲	026613145600	3/8" MIP x 3"	Chrome	25	3.6
113-06-3.5-CX	▲	026613145594	3/8" MIP x 3-1/2"	Chrome	25	4.4
113-06-4-RX	▲	026613145686	3/8" MIP x 4"	Rough	25	4.9
113-06-4-CX	▲	026613145679	3/8" MIP x 4"	Chrome	25	5.1
113-06-4.5-CX	▲	026613145662	3/8" MIP x 4-1/2"	Chrome	25	5.5
113-06-5-CX	▲	026613145709	3/8" MIP x 5"	Chrome	25	6.1
113-06-5.5-CX	▲	026613145693	3/8" MIP x 5-1/2"	Chrome	25	7.7
113-06-6-CX	▲	026613145730	3/8" MIP x 6"	Chrome	25	7.5
113-08-1.5-RX	▲	026613145754	1/2" MIP x 1-1/2"	Rough	5	0.5
113-08-1.5-CX	▲	026613145747	1/2" MIP x 1-1/2"	Chrome	5	0.5
113-08-2.5-RX	▲	026613145778	1/2" MIP x 2-1/2"	Rough	5	0.9
113-08-2.5-CX	▲	026613145761	1/2" MIP x 2-1/2"	Chrome	5	0.9
113-08-2-RX	▲	026613145792	1/2" MIP x 2"	Rough	5	0.6
113-08-2-CX	▲	026613145785	1/2" MIP x 2"	Chrome	5	0.6
113-08-3-RX	▲	026613145839	1/2" MIP x 3"	Rough	5	1.0
113-08-3-CX	▲	026613145822	1/2" MIP x 3"	Chrome	5	0.9
113-08-3.5-RX	▲	026613145815	1/2" MIP x 3-1/2"	Rough	5	1.3
113-08-3.5-CX	▲	026613145808	1/2" MIP x 3-1/2"	Chrome	5	1.3
113-08-4-RX	▲	026613145907	1/2" MIP x 4"	Rough	5	1.4
113-08-4-CX	▲	026613145891	1/2" MIP x 4"	Chrome	5	1.3
113-08-4.5-CX	▲	026613145884	1/2" MIP x 4-1/2"	Chrome	5	1.5
113-08-5.5-RX	▲	026613145921	1/2" MIP x 5-1/2"	Rough	5	1.7
113-08-5.5-CX	▲	026613145914	1/2" MIP x 5-1/2"	Chrome	5	1.7
113-08-5-RX	▲	026613145945	1/2" MIP x 5"	Rough	5	1.4
113-08-5-CX	▲	026613145938	1/2" MIP x 5"	Chrome	5	1.4
113-08-6-RX	▲	026613145983	1/2" MIP x 6"	Rough	5	2.0
113-08-6-CX	▲	026613145976	1/2" MIP x 6"	Chrome	5	2.0
113-12-1.5-RX	▲	026613145990	3/4" MIP x 1-1/2"	Rough	5	0.7
113-12-2-RX	▲	026613146027	3/4" MIP x 2"	Rough	5	0.9
113-12-2-CX	▲	026613146010	3/4" MIP x 2"	Chrome	5	0.9
113-12-2.5-RX	▲	026613146003	3/4" MIP x 2-1/2"	Rough	5	1.0
113-12-3-RX	▲	026613146041	3/4" MIP x 3"	Rough	5	1.3
113-12-3.5-RX	▲	026613146034	3/4" MIP x 3-1/2"	Rough	5	1.7
113-12-4-RX	▲	026613146065	3/4" MIP x 4"	Rough	5	1.8



▲ Certified Compliant to NSF/ANSI 372 for potable water applications

PART NO.	USE	UPC	DESCRIPTION	FINISH	QTY	LBS
Pipe Nipples (cont.)						
113-12-4.5-CX	▲	026613146058	3/4" MIP x 4-1/2"	Chrome	5	0.1
113-12-5-RX	▲	026613146072	3/4" MIP x 5"	Rough	5	2.3
113-12-6-RX	▲	026613146089	3/4" MIP x 6"	Rough	5	2.8
113-16-2-RX	▲	026613146096	1" MIP x 2"	Rough	5	1.2
113-16-3-RX	▲	026613146102	1" MIP x 3"	Rough	5	1.8
113-16-4-RX	▲	026613146119	1" MIP x 4"	Rough	5	0.1
113-16-6-RX	▲	026613146126	1" MIP x 6"	Rough	5	3.9



Pipe Tees

203-2	○	026613003894	1/8" FIP, All 3 Ends	Rough	10	0.8
203-2X	▲	026613147161	1/8" FIP, All 3 Ends	Rough	10	0.8
203-4	○	026613003900	1/4" FIP, All 3 Ends	Rough	10	1.6
203-4X	▲	026613147185	1/4" FIP, All 3 Ends	Rough	10	1.6
203-6	○	026613003917	3/8" FIP, All 3 Ends	Rough	10	2.2
203-6X	▲	026613147215	3/8" FIP, All 3 Ends	Rough	10	2.2
203-8	○	026613003924	1/2" FIP, All 3 Ends	Rough	10	4.3
203-8X	▲	026613147246	1/2" FIP, All 3 Ends	Rough	10	4.3
203-12	○	026613004419	3/4" FIP, All 3 Ends	Rough	10	5.3



Street Tees

225-2	○	026613075907	1/8" FIP x 1/8" MIP x 1/8" FIP	Rough	10	0.7
225-2X	▲	026613147550	1/8" FIP x 1/8" MIP x 1/8" FIP	Rough	10	0.7
225-4	○	026613075914	1/4" FIP x 1/4" MIP x 1/4" FIP	Rough	10	1.5
225-4X	▲	026613147581	1/4" FIP x 1/4" MIP x 1/4" FIP	Rough	10	1.5
225-6	○	026613075921	3/8" FIP x 3/8" MIP x 3/8" FIP	Rough	10	1.9
225-6X	▲	026613147598	3/8" FIP x 3/8" MIP x 3/8" FIP	Rough	10	1.9
225-8	○	026613075938	1/2" FIP x 1/2" MIP x 1/2" FIP	Rough	10	3.9



Female Pipe Cross

102-2	○	026613074672	1/8" FIP, All 4 Ends	Rough	10	0.6
102-4	○	026613074689	1/4" FIP, All 4 Ends	Rough	10	1.5
102-6	○	026613074696	3/8" FIP, All 4 Ends	Rough	10	1.1
102-8	○	026613074702	1/2" FIP, All 4 Ends	Rough	10	3.6
102-12	○	026613074665	3/4" FIP, All 4 Ends	Rough	10	7.3



Male Branch Tees

226-2	○	026613075952	1/8" FIP x 1/8" FIP x 1/8" MIP	Rough	25	1.8
226-4	○	026613075969	1/4" FIP x 1/4" FIP x 1/4" MIP	Rough	25	3.9
226-4X	▲	026613147659	1/4" FIP x 1/4" FIP x 1/4" MIP	Rough	25	3.5
226-6	○	026613075976	3/8" FIP x 3/8" FIP x 3/8" MIP	Rough	10	1.9
226-8	○	026613075983	1/2" FIP x 1/2" FIP x 1/2" MIP	Rough	10	3.8
226-12	○	026613075945	3/4" FIP x 3/4" FIP x 3/4" MIP	Rough	5	2.8



○ Not for use in potable water applications.

▲ Certified Compliant to NSF/ANSI 372 for potable water applications

Brass Hose Barb Fittings

Product Applications

- For use with plastic or rubber tubing. Installation requires hose clamp.

Product Advantages

- BrassCraft® Hose Barb Fittings are manufactured with Dryseal pipe threads.
- Connectors, unions, nuts, elbows and tees machined from brass rod.
- Backed by BrassCraft Mfg.'s 65 plus year history and reputation for quality and service.

How to Order

- Order fittings by part number and product name.

Special Orders

- Special fitting configurations and sizes may be ordered. Please furnish a print or sketch of your needs with your inquiry.
- Fittings are available in bulk quantities on request. Contact your sales representative for details.



Assembly Instructions

1. Cut hose cleanly and squarely to length.
2. Slide hose clamp onto hose end.
3. Lubricate hose with a drop of oil. Push hose onto fitting until hose reaches fitting stop ring or hex.
4. Move hose clamp over hose and barb. Tighten with screwdriver or wrench.

PART NO.	USE	UPC	DESCRIPTION	FINISH	QTY	LBS
----------	-----	-----	-------------	--------	-----	-----

Hose Barb Splicers

73-3	○	026613087399	3/16" ID Hose Barb, Both Ends	Rough	25	0.6
73-3X	▲	026613148915	3/16" ID Hose Barb, Both Ends	Rough	25	0.6
73-4	○	026613082462	1/4" ID Hose Barb, Both Ends	Rough	25	0.6
73-4X	▲	026613148922	1/4" ID Hose Barb, Both Ends	Rough	25	0.6
73-5	○	026613082479	5/16" ID Hose Barb, Both Ends	Rough	25	0.7
73-5X	▲	026613148939	5/16" ID Hose Barb, Both Ends	Rough	25	0.7
73-6	○	026613082455	3/8" ID Hose Barb, Both Ends	Rough	25	0.9
73-6X	▲	026613148946	3/8" ID Hose Barb, Both Ends	Rough	25	0.9
73-8	○	026613082578	1/2" ID Hose Barb, Both Ends	Rough	25	1.6
73-8X	▲	026613148953	1/2" ID Hose Barb, Both Ends	Rough	25	1.6



Female Hose Barb Adaptors

126-2-2	○	026613084732	1/8" ID Hose Barb x 1/8" FIP	Rough	10	0.2
126-3-2	○	026613084749	3/16" ID Hose Barb x 1/8" FIP	Rough	25	0.6
126-4-2	○	026613084763	1/4" ID Hose Barb x 1/8" FIP	Rough	25	0.6
126-4-2X	▲	026613146683	1/4" ID Hose Barb x 1/8" FIP	Rough	25	0.9
126-4-4	○	026613012285	1/4" ID Hose Barb x 1/4" FIP	Rough	25	1.3
126-4-4X	▲	026613146690	1/4" ID Hose Barb x 1/4" FIP	Rough	25	1.3
126-5-2	○	026613084794	5/16" ID Hose Barb x 1/8" FIP	Rough	10	0.3
126-5-4	○	026613082639	5/16" ID Hose Barb x 1/4" FIP	Rough	25	1.4
126-6-2	○	026613084817	3/8" ID Hose Barb x 1/8" FIP	Rough	25	0.7
126-6-4	○	026613082516	3/8" ID Hose Barb x 1/4" FIP	Rough	25	1.8
126-6-4X	▲	026613146706	3/8" ID Hose Barb x 1/4" FIP	Rough	25	1.8
126-6-6	○	026613012292	3/8" ID Hose Barb x 3/8" FIP	Rough	25	2.1
126-6-6X	▲	026613146713	3/8" ID Hose Barb x 3/8" FIP	Rough	25	2.1



- Not for use in potable water applications.
- ▲ Certified Compliant to NSF/ANSI 372 for potable water applications



PART NO.	USE	UPC	DESCRIPTION	FINISH	QTY	LBS
Female Hose Barb Adaptors (cont.)						
126-6-8	○	026613084855	3/8" ID Hose Barb x 1/2" FIP	Rough	25	3.5
126-8-4	○	026613084879	1/2" ID Hose Barb x 1/4" FIP	Rough	10	0.6
126-8-6	○	026613084886	1/2" ID Hose Barb x 3/8" FIP	Rough	25	2.6
126-8-8	○	026613012308	1/2" ID Hose Barb x 1/2" FIP	Rough	25	4.1
126-8-8X	▲	026613146737	1/2" ID Hose Barb x 1/2" FIP	Rough	25	4.1
126-12-12	○	026613084725	3/4" ID Hose Barb x 3/4" FIP	Rough	10	2.3

Male Hose Barb Adaptors



125-2-2	○	026613082530	1/8" ID Hose Barb x 1/8" MIP	Rough	25	0.5
125-2-2X	▲	026613146416	1/8" ID Hose Barb x 1/8" MIP	Rough	25	0.5
125-2-4	○	026613084435	1/8" ID Hose Barb x 1/4" MIP	Rough	10	0.3
125-2-4X	▲	026613146430	1/8" ID Hose Barb x 1/4" MIP	Rough	10	0.3
125-3-2	○	026613088228	3/16" ID Hose Barb x 1/8" MIP	Rough	10	0.3
125-3-2X	▲	026613146447	3/16" ID Hose Barb x 1/8" MIP	Rough	10	0.2
125-3-4	○	026613084459	3/16" ID Hose Barb x 1/4" MIP	Rough	10	0.3
125-3-4X	▲	026613146461	3/16" ID Hose Barb x 1/4" MIP	Rough	10	0.3
125-4-2	○	026613082400	1/4" ID Hose Barb x 1/8" MIP	Rough	25	0.6
125-4-2X	▲	026613146478	1/4" ID Hose Barb x 1/8" MIP	Rough	25	0.6
125-4-4	○	026613003818	1/4" ID Hose Barb x 1/4" MIP	Rough	25	0.9
125-4-4X	▲	026613146492	1/4" ID Hose Barb x 1/4" MIP	Rough	25	0.9
125-4-6	○	026613082417	1/4" ID Hose Barb x 3/8" MIP	Rough	25	1.3
125-4-6X	▲	026613146515	1/4" ID Hose Barb x 3/8" MIP	Rough	25	1.3
125-4-8	○	026613084510	1/4" ID Hose Barb x 1/2" MIP	Rough	10	0.9
125-4-8X	▲	026613146522	1/4" ID Hose Barb x 1/2" MIP	Rough	10	0.9
125-5-2	○	026613084527	5/16" ID Hose Barb x 1/8" MIP	Rough	10	0.3
125-5-2X	▲	026613146539	5/16" ID Hose Barb x 1/8" MIP	Rough	10	0.3
125-5-4	○	026613082486	5/16" ID Hose Barb x 1/4" MIP	Rough	10	0.4
125-5-4X	▲	026613146546	5/16" ID Hose Barb x 1/4" MIP	Rough	10	0.4
125-5-6	○	026613084558	5/16" ID Hose Barb x 3/8" MIP	Rough	10	0.6
125-6-2	○	026613082615	3/8" ID Hose Barb x 1/8" MIP	Rough	25	1.0
125-6-2X	▲	026613146553	3/8" ID Hose Barb x 1/8" MIP	Rough	25	1.0
125-6-4	○	026613082394	3/8" ID Hose Barb x 1/4" MIP	Rough	25	1.0
125-6-4X	▲	026613146577	3/8" ID Hose Barb x 1/4" MIP	Rough	25	1.0
125-6-6	○	026613003825	3/8" ID Hose Barb x 3/8" MIP	Rough	25	1.6
125-6-6X	▲	026613146607	3/8" ID Hose Barb x 3/8" MIP	Rough	25	1.6
125-6-8	○	026613053738	3/8" ID Hose Barb x 1/2" MIP	Rough	25	2.4
125-6-8X	▲	026613146638	3/8" ID Hose Barb x 1/2" MIP	Rough	25	2.4
125-8-4	○	026613082523	1/2" ID Hose Barb x 1/4" MIP	Rough	25	1.4
125-8-4X	▲	026613146645	1/2" ID Hose Barb x 1/4" MIP	Rough	25	1.4
125-8-6	○	026613082448	1/2" ID Hose Barb x 3/8" MIP	Rough	25	1.8
125-8-6X	▲	026613146652	1/2" ID Hose Barb x 3/8" MIP	Rough	25	1.8
125-8-8	○	026613084688	1/2" ID Hose Barb x 1/2" MIP	Rough	25	2.7
125-8-8X	▲	026613146669	1/2" ID Hose Barb x 1/2" MIP	Rough	25	2.7
125-8-12	○	026613082509	1/2" ID Hose Barb x 3/4" MIP	Rough	25	3.7

○ Not for use in potable water applications.

▲ Certified Compliant to NSF/ANSI 372 for potable water applications

PART NO.	USE	UPC	DESCRIPTION	FINISH	QTY	LBS
Male Hose Barb Adaptors (cont.)						
125-10-6	○	026613084329	5/8" ID Hose Barb x 3/8" MIP	Rough	25	2.2
125-10-6X	▲	026613146317	5/8" ID Hose Barb x 3/8" MIP	Rough	25	2.2
125-10-8	○	026613082585	5/8" ID Hose Barb x 1/2" MIP	Rough	25	3.0
125-10-8X	▲	026613146331	5/8" ID Hose Barb x 1/2" MIP	Rough	25	3.0
125-10-12	○	026613084305	5/8" ID Hose Barb x 3/4" MIP	Rough	25	7.0
125-12-8	○	026613082622	3/4" ID Hose Barb x 1/2" MIP	Rough	10	1.1
125-12-8X	▲	026613146362	3/4" ID Hose Barb x 1/2" MIP	Rough	10	1.1
125-12-12	○	026613084350	3/4" ID Hose Barb x 3/4" MIP	Rough	10	1.8
125-12-12X	▲	026613146355	3/4" ID Hose Barb x 3/4" MIP	Rough	10	1.8
125-16-12	○	026613084398	1" ID Hose Barb x 3/4" MIP	Rough	10	3.0
125-16-12X	▲	026613146386	1" ID Hose Barb x 3/4" MIP	Rough	10	3.0
125-16-16	○	026613084411	1" ID Hose Barb x 1" MIP	Rough	10	3.3
125-16-16X	▲	026613146393	1" ID Hose Barb x 1" MIP	Rough	10	3.3



Female Flare Hose Barb Adaptors with Swivel

146-4-4	○	026613085418	1/4" ID Hose Barb x 1/4" Female Flare	Rough	25	0.9
146-4-4X	▲	026613146867	1/4" ID Hose Barb x 1/4" Female Flare	Rough	25	0.9
146-4-6	○	026613085432	1/4" ID Hose Barb x 3/8" Female Flare	Rough	25	1.6
146-6-6	○	026613085456	3/8" ID Hose Barb x 3/8" Female Flare	Rough	25	1.7
146-6-6X	▲	026613146881	3/8" ID Hose Barb x 3/8" Female Flare	Rough	25	1.7
146-6-8	○	026613085470	3/8" ID Hose Barb x 1/2" Female Flare	Rough	25	2.6
146-6-8X	▲	026613146898	3/8" ID Hose Barb x 1/2" Female Flare	Rough	25	2.6
146-8-8	○	026613085487	1/2" ID Hose Barb x 1/2" Female Flare	Rough	25	2.7



Female Hose Barb Adaptors with Swivel Ball

128-4-4	○	026613084985	1/4" ID Hose Barb x 1/4" NPSM	Rough	25	1.0
128-4-4X	▲	026613146768	1/4" ID Hose Barb x 1/4" NPSM	Rough	25	1.0
128-6-4	○	026613085012	3/8" ID Hose Barb x 1/4" NPSM	Rough	25	1.4
128-6-6	○	026613085036	3/8" ID Hose Barb x 3/8" NPSM	Rough	25	1.5
128-8-6	○	026613085050	1/2" ID Hose Barb x 3/8" NPSM	Rough	10	0.8
128-8-8	○	026613085067	1/2" ID Hose Barb x 1/2" NPSM	Rough	25	2.0
128-12-12	○	026613084978	3/4" ID Hose Barb x 3/4" NPSM	Rough	10	1.4



Male Ball Joint Adaptors (Use with 128 Series Fittings)

127-4-2	○	026613084916	1/4" NPSM x 1/8" MIP	Rough	25	0.9
127-4-4	○	026613084930	1/4" NPSM x 1/4" MIP	Rough	25	1.0
127-8-8	○	026613082608	1/2" NPSM x 1/2" MIP	Rough	25	3.0



90° Male Hose Barb Elbows

129-4-2	○	026613085111	1/4" ID Hose Barb x 1/8" MIP	Rough	25	1.3
129-4-4	○	026613085135	1/4" ID Hose Barb x 1/4" MIP	Rough	25	1.4
129-4-4X	▲	026613146775	1/4" ID Hose Barb x 1/4" MIP	Rough	25	1.4
129-5-2	○	026613085166	5/16" ID Hose Barb x 1/8" MIP	Rough	25	1.3
129-5-4	○	026613085180	5/16" ID Hose Barb x 1/4" MIP	Rough	25	1.4
129-5-6	○	026613085197	5/16" ID Hose Barb x 3/8" MIP	Rough	25	1.7
129-6-2	○	026613085203	3/8" ID Hose Barb x 1/8" MIP	Rough	25	1.3



○ Not for use in potable water applications.

▲ Certified Compliant to NSF/ANSI 372 for potable water applications

PART NO.	USE	UPC	DESCRIPTION	FINISH	QTY	LBS
----------	-----	-----	-------------	--------	-----	-----

90° Male Hose Barb Elbows (cont.)



129-6-4	○	026613082424	3/8" ID Hose Barb x 1/4" MIP	Rough	25	1.3
129-6-6	○	026613082592	3/8" ID Hose Barb x 3/8" MIP	Rough	25	1.8
129-6-6X	▲	026613146829	3/8" ID Hose Barb x 3/8" MIP	Rough	25	1.8
129-8-4	○	026613085241	1/2" ID Hose Barb x 1/4" MIP	Rough	25	2.1
129-8-6	○	026613082561	1/2" ID Hose Barb x 3/8" MIP	Rough	25	2.4
129-8-8	○	026613082332	1/2" ID Hose Barb x 1/2" MIP	Rough	25	2.9
129-10-6	○	026613085081	5/8" ID Hose Barb x 3/8" MIP	Rough	25	2.6
129-10-8	○	026613085104	5/8" ID Hose Barb x 1/2" MIP	Rough	25	3.3

45° Male Hose Barb Elbows



139-4-2	○	026613085289	1/4" ID Hose Barb x 1/8" MIP	Rough	25	0.8
139-6-4	○	026613085357	3/8" ID Hose Barb x 1/4" MIP	Rough	25	1.4
139-6-6	○	026613085371	3/8" ID Hose Barb x 3/8" MIP	Rough	25	1.9
139-8-4	○	026613085388	1/2" ID Hose Barb x 1/4" MIP	Rough	25	1.7
139-8-6	○	026613085401	1/2" ID Hose Barb x 3/8" MIP	Rough	25	2.0

Hose Barb Tees



HBT2-6	○	026613082547	3/8" ID Hose Barb, All 3 Ends	Rough	25	1.5
HBT2-6X	▲	026613149646	3/8" ID Hose Barb, All 3 Ends	Rough	25	1.5

Male Hose Barb Tees (MIP on Branch)



HBT1-664	○	026613087443	3/8" ID Hose Barb x 3/8" ID Hose Barb x 1/4" MIP	Rough	25	1.7
----------	---	--------------	--	-------	----	-----

○ Not for use in potable water applications.

▲ Certified Compliant to NSF/ANSI 372 for potable water applications

Brass Garden Hose Fittings

Product Applications

- For use with residential and commercial-grade garden hose.

Product Advantages

- Connectors, unions, nuts, elbows and tees machined from brass rod.
- Backed by BrassCraft Mfg.'s 65 plus year history and reputation for quality and service.

How to Order

- Order fittings by part number and product name.

Special Orders

- Special fitting configurations and sizes may be ordered. Please furnish a print or sketch of your needs with your inquiry.
- Fittings are available in bulk quantities on request. Contact your sales representative for details.



Assembly Instructions

- All female hose connections require a rubber washer inserted prior to installation.

PART NO.	USE	UPC	DESCRIPTION	FINISH	QTY	LBS
----------	-----	-----	-------------	--------	-----	-----

Garden Hose Caps

HC-1	○	026613079752	3/4" Female Hose Thread, Washer Included	Rough	25	1.2
HC-1X	▲	026613136141	3/4" Female Hose Thread	Rough	25	1.5



Garden Hose Caps with 8" Chain

HC-8	○	026613079769	3/4" Female Hose Thread, Washer Included	Rough	25	1.6
------	---	--------------	--	-------	----	-----



Garden Hose Round Nuts

HNR-1	●	026613079820	3/4" Female Hose Thread	Rough	10	0.4
-------	---	--------------	-------------------------	-------	----	-----



Female Swivel Hose Unions

HUS-12	○	026613080024	3/4" Female Hose Thread, Both Ends	Rough	25	2.4
HUS-12X	▲	026613137711	3/4" Female Hose Thread, Both Ends	Rough	25	2.6



Male Hose Unions

HU22-12MH	○	026613080000	3/4" Male Hose Thread, Both Ends	Rough	25	3.2
HU22-12MHX	▲	026613150000	3/4" Male Hose Thread, Both Ends	Rough	25	3.2



Male Hose Adaptors (FIP End)

HU12-8-12	○	026613079868	3/4" Male Hose Thread x 1/2" FIP	Rough	25	2.9
HU12-8-12X	▲	026613149943	3/4" Male Hose Thread x 1/2" FIP	Rough	25	2.9
HU12-12-12	○	026613079851	3/4" Male Hose Thread x 3/4" FIP	Rough	25	2.5
HU12-12-12X	▲	026613149837	3/4" Male Hose Thread Inlet x 3/4" FIP Outlet	Rough	25	2.5



Male Hose Adaptors (MIP End)

HU22-8-12	○	026613080017	3/4" Male Hose Thread x 1/2" MIP	Rough	25	3.3
HU22-8-12X	▲	026613135502	1/2" MIP x 3/4" Male Hose Thread	Rough	25	3.3
HU22-12-12	○	026613079981	3/4" Male Hose Thread x 3/4" MIP	Rough	25	3.4



- Not for use in potable water applications.
- Can be used in potable water applications.
- ▲ Certified Compliant to NSF/ANSI 372 for potable water applications



PART NO.	USE	UPC	DESCRIPTION	FINISH	QTY	LBS
Male Hose Adaptors (MIP End) (cont.)						
HU22-12-12X	▲	026613135489	3/4" MIP x 3/4" Male Hose Thread	Rough	25	3.4
HU22-12-12TP	○	026613079998	3/4" Male Hose Thread x 3/4" MIP (Tapped 1/2" FIP)	Rough	25	3.9
HU22-12-12TPX	▲	026613149998	3/4" Male Hose Thread x 3/4" MIP (Tapped 1/2" FIP)	Rough	25	3.9



Female Hose Adaptors (FIP End)						
HU11-8-12	○	026613079844	3/4" Female Hose Thread x 1/2" FIP	Rough	25	3.0
HU11-8-12X	▲	026613149820	3/4" Female Hose Thread Inlet x 1/2" FIP Outlet	Rough	25	3.0
HU11-12-12	○	026613079837	3/4" Female Hose Thread x 3/4" FIP	Rough	25	2.2
HU11-12-12X	▲	026613149813	3/4" Female Hose Thread Inlet x 3/4" FIP Outlet	Rough	25	2.2



Female Hose Adaptors (MIP End)						
HU21-8-12	○	026613079974	3/4" Female Hose Thread x 1/2" MIP	Rough	25	2.6
HU21-8-12X	▲	026613149981	3/4" Female Hose Thread x 1/2" MIP	Rough	25	2.9
HU21-12-12	○	026613079967	3/4" Female Hose Thread x 3/4" MIP	Rough	25	2.9
HU21-12-12X	▲	026613149967	3/4" Female Hose Thread x 3/4" MIP	Rough	25	2.9



Female Swivel Hose Adaptors (FIP End)						
HUS11-8-12	○	026613080048	3/4" Female Hose Thread x 1/2" FIP	Rough	25	2.2
HUS11-8-12X	▲	026613137797	1/2" FIP Inlet x 3/4" Female Hose Thread Outlet	Rough	25	2.3
HUS11-12-12	○	026613080031	3/4" Female Hose Thread x 3/4" FIP	Rough	25	3.0
HUS11-12-12X	▲	026613137698	3/4" FIP x 3/4" Female Hose Thread	Rough	25	3.0



Female Swivel Hose Adaptors (MIP End)						
62H-4-12	○	026613079400	3/4" Female Hose Thread x 1/4" MIP	Rough	25	3.0
62H-4-12X	▲	026613147901	3/4" Female Hose Thread x 1/4" MIP	Rough	25	3.1



Female Hose Adaptors (Flare End)						
HFU21-6-12	○	026613079783	3/4" Female Hose Thread x 3/8" OD Tube	Rough	25	2.7



Male Hose Adaptors (Flare End)						
HFU22-6-12	○	026613079806	3/4" Male Hose Thread x 3/8" OD Tube	Rough	25	3.3
HFU22-8-12	○	026613079813	3/4" Male Hose Thread x 1/2" OD Tube	Rough	25	4.1



Female Hose Swivel Barbed Adaptors with Round Nut						
HU126-8-12	○	026613079943	3/4" Female Hose Thread x 1/2" ID Hose Barb	Rough	10	1.1
HU126-8-12X	▲	026613149929	3/4" Female Hose Thread x 1/2" ID Hose Barb	Rough	10	0.9
HU126-10-12	○	026613079905	3/4" Female Hose Thread x 5/8" ID Hose Barb	Rough	10	1.0
HU126-10-12X	▲	026613149899	3/4" Female Hose Thread x 5/8" ID Hose Barb	Rough	10	1.0
HU126-12-12	○	026613079929	3/4" Female Hose Thread x 3/4" ID Hose Barb	Rough	10	1.2
HU126-12-12X	▲	026613149912	3/4" Female Hose Thread x 3/4" ID Hose Barb	Rough	10	1.1

○ Not for use in potable water applications.

▲ Certified Compliant to NSF/ANSI 372 for potable water applications

PART NO.	USE	UPC	DESCRIPTION	FINISH	QTY	LBS
----------	-----	-----	-------------	--------	-----	-----

Female Hose Swivel Barbed Adaptors with Hex Nut

HU126-8-12H	○	026613079950	3/4" Female Hose Thread x 1/2" ID Hose Barb	Rough	10	1.2
HU126-8-12HX	▲	026613149936	3/4" Female Hose Thread x 1/2" ID Hose Barb	Rough	10	1.1
HU126-10-12H	○	026613079912	3/4" Female Hose Thread x 5/8" ID Hose Barb	Rough	10	1.1
HU126-10-12HX	▲	026613149905	3/4" Female Hose Thread x 5/8" ID Hose Barb	Rough	10	1.1
HU126-12-12H	○	026613079936	3/4" Female Hose Thread x 3/4" ID Hose Barb	Rough	10	1.4



Male Hose Barbed Adaptors

HU125-8-12	○	026613079899	3/4" Male Hose Thread x 1/2" ID Hose Barb	Rough	10	1.3
HU125-8-12X	▲	026613149875	3/4" Male Hose Thread x 1/2" ID Hose Barb	Rough	10	1.3
HU125-10-12	○	026613079875	3/4" Male Hose Thread x 5/8" ID Hose Barb	Rough	10	1.5
HU125-10-12X	▲	026613149851	3/4" Male Hose Thread x 5/8" ID Hose Barb	Rough	10	1.4
HU125-12-12	○	026613079882	3/4" Male Hose Thread x 3/4" ID Hose Barb	Rough	10	1.5
HU125-12-12X	▲	026613149868	3/4" Male Hose Thread x 3/4" ID Hose Barb	Rough	10	1.5



Y Hose Fittings

Y-9	○	026613080055	3/4" Female Hose Thread x 3/4" Male Hose Thread x 3/4" Male Hose Thread	Rough	25	7.2
-----	---	--------------	---	-------	----	-----



Garden Hose Dishwasher Elbows

HES-6-12	○	026613139975	3/4" Female Hose Thread x 3/8" OD Comp, Hose Washer Included	Rough	50	7.4
HES-6-12WNM	○	026613141121	3/4" Female Hose Thread x 3/8" OD Comp, Comp Nut & Sleeve, Hose Washer Included	Rough	50	9.9
HES-8-12	○	026613141534	3/4" Female Hose Thread x 3/8" OD Comp, Hose Washer Included	Rough	25	3.2



○ Not for use in potable water applications.

▲ Certified Compliant to NSF/ANSI 372 for potable water applications

Part Numbering System

Example:

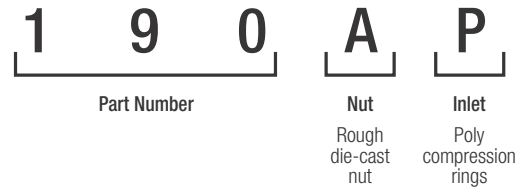

Part Number

Basic part number.
1-3 digits.

Nut

A Rough die-cast nut
B Chrome die-cast nut
C Rough brass nut
D Chrome brass nut

Option

P Poly compression rings
L Lead compression rings
R With rubber washer
(P/N 90BR, 90DR, 94BR,
94DR, 96BR, 96DR,
98DR Only)

Waste Connectors Machined from Extruded Solid Brass

Entire connector body is produced from solid brass. Eliminates all potential pin holes and porosity.

- **Uniform Wall Thickness** – No variations in wall thickness. Close dimensional tolerances assured.
- **Cleaner, Smoother Water Ways** – Uniform smooth internal surfaces allow full unobstructed flow through connector.
- **Better Threads** – Uniform cleaner threads ensure positive threaded connections. Less chance of cross threading.
- **Smooth Finished Appearance...Easier to Assemble** – No burrs or rough surfaces to catch or hang up during assembly.

PART NO.	USE	UPC	DESCRIPTION	FINISH	QTY	LBS
Compression Slip Nuts						
90A	026613056258		1-1/4" OD Tube x 1-1/4" FIP	Die Cast, Rough	25	1.0
90B	026613056272		1-1/4" OD Tube x 1-1/4" FIP	Die Cast, Chrome	25	1.4
90C	026613056296		1-1/4" OD Tube x 1-1/4" FIP	Brass, Rough	25	1.7
90D	026613056302		1-1/4" OD Tube x 1-1/4" FIP	Brass, Chrome	25	1.7
94D	026613056418		1-3/8" OD Tube x 1-1/2" FIP	Brass, Chrome	25	2.5
96A	026613056449		1-1/2" OD Tube x 1-1/2" FIP	Die Cast, Rough	25	1.3
96B	026613056470		1-1/2" OD Tube x 1-1/2" FIP	Die Cast, Chrome	25	1.5
96C	026613056494		1-1/2" OD Tube x 1-1/2" FIP	Brass, Rough	25	1.9
96D	026613056517		1-1/2" OD Tube x 1-1/2" FIP	Brass, Chrome	25	1.9
97B	026613056586		1-1/4" OD Tube x 1-1/2" FIP	Die Cast, Chrome	25	1.6



PART NO.	UPC	DESCRIPTION	FINISH	QTY	LBS
----------	-----	-------------	--------	-----	-----

Compression Slip Nuts & Rubber Washers

90BR	026613056289	1-1/4" OD Tube x 1-1/4" FIP	Die Cast, Chrome	25	1.5
96BR	026613056487	1-1/2" OD Tube x 1-1/2" FIP	Die Cast, Chrome	25	1.6



Compression Rings

90	026613056241	1-1/4" OD Tube	Brass	25	0.4
96	026613056432	1-1/2" OD Tube	Brass	25	0.6
90P	026613056333	1-1/4" OD Tube	Polyethylene	25	0.1
96P	026613056548	1-1/2" OD Tube	Polyethylene	25	0.1
90R	026613056340	1-1/4" OD Tube	Rubber	25	0.1
96R	026613056555	1-1/2" OD Tube	Rubber	25	0.1
96L	026613056531	1-1/2" OD Tube	Lead	25	1.5



Compression Female Waste Connectors

191B	026613055671	1-1/4" OD Tube x 1-1/4" FIP	Die Cast, Chrome	5	1.5
191C	026613055695	1-1/4" OD Tube x 1-1/4" FIP	Brass, Rough	5	1.6
193A	026613055770	1-1/4" OD Tube x 1-1/2" FIP	Die Cast, Rough	5	1.8
193B	026613002446	1-1/4" OD Tube x 1-1/2" FIP	Die Cast, Chrome	5	1.8
193C	026613055794	1-1/4" OD Tube x 1-1/2" FIP	Rough Brass	5	1.9
197A	026613055909	1-1/2" OD Tube x 1-1/2" FIP	Die Cast, Rough	5	1.7
197B	026613002453	1-1/2" OD Tube x 1-1/2" FIP	Die Cast, Chrome	5	1.9
197C	026613055947	1-1/2" OD Tube x 1-1/2" FIP	Rough Brass	5	2.0
197D	026613055978	1-1/2" OD Tube x 1-1/2" FIP	Chrome	5	2.0



Compression Male Waste Connectors (Female Sweat Tap)

190A	026613055596	1-1/4" OD Tube x 1-1/4" MIP (Tapped 1-3/8" OD Female Sweat)	Die Cast, Rough	5	1.4
190B	026613055619	1-1/4" OD Tube x 1-1/4" MIP (Tapped 1-3/8" OD Female Sweat)	Die Cast, Chrome	5	1.5
190C	026613055633	1-1/4" OD Tube x 1-1/4" MIP (Tapped 1-3/8" OD Female Sweat)	Rough Brass	5	1.5
192A	026613055718	1-1/4" OD Tube x 1-1/2" MIP (Tapped 1-5/8" OD Female Sweat)	Die Cast, Rough	5	1.6
192B	026613002422	1-1/4" OD Tube x 1-1/2" MIP (Tapped 1-5/8" OD Female Sweat)	Die Cast, Chrome	5	1.6
192C	026613055749	1-1/4" OD Tube x 1-1/2" MIP (Tapped 1-5/8" OD Female Sweat)	Rough Brass	5	1.7





PART NO.	UPC	DESCRIPTION	FINISH	QTY	LBS
Compression Male Waste Connectors (Female Sweat Tap) (cont.)					
196A	026613055824	1-1/2" OD Tube x 1-1/2" MIP (Tapped 1-5/8" OD Female Sweat)	Die Cast, Rough	5	1.5
196B	026613002439	1-1/2" OD Tube x 1-1/2" MIP (Tapped 1-5/8" OD Female Sweat)	Die Cast, Chrome	5	1.5
196C	026613055879	1-1/2" OD Tube x 1-1/2" MIP (Tapped 1-5/8" OD Female Sweat)	Brass, Rough	5	1.6

Compression Female Sweat Waste Connectors



200A	026613056081	1-1/4" OD Tube x 1-1/4" ID Female Sweat	Die Cast, Rough	5	1.4
200B	026613056098	1-1/4" OD Tube x 1-1/4" ID Female Sweat	Die Cast, Chrome	5	1.5
200C	026613056104	1-1/4" OD Tube x 1-1/4" ID Female Sweat	Brass, Rough	5	1.7
198A	026613055992	1-1/4" OD Tube x 1-1/2" ID Female Sweat	Die Cast, Rough	5	1.4
198B	026613056005	1-1/4" OD Tube x 1-1/2" ID Female Sweat	Die Cast, Chrome	5	1.5
198D	026613056029	1-1/4" OD Tube x 1-1/2" ID Female Sweat	Brass, Chrome	5	1.7
199A	026613056036	1-1/2" OD Tube x 1-1/2" ID Female Sweat	Die Cast, Rough	5	1.7
199B	026613056043	1-1/2" OD Tube x 1-1/2" ID Female Sweat	Die Cast, Chrome	5	1.8

Compression Male Sweat Waste Connectors



202A	026613056128	1-1/4" OD Tube x 1-1/4" OD Male Sweat	Die Cast, Rough	5	1.4
202D	026613056159	1-1/4" OD Tube x 1-1/4" OD Male Sweat	Brass, Chrome	5	1.5
203A	026613056166	1-1/2" OD Tube x 1-1/2" OD Male Sweat	Die Cast, Rough	5	1.7
204C	026613056227	1-1/4" OD Tube x 1-1/2" OD Male Sweat	Brass, Rough	5	1.5

Brass Drain & Shut-Off Cocks

Product Applications

- For use with low pressure air, water, gas and fluids (lubricant may not be compatible with some fluids).
- Backed by BrassCraft Mfg.'s 65 plus year history and reputation for quality and service.

How to Order

- Order valves and cocks by part number and product name.

Special Orders

- Special fitting configurations and sizes may be ordered. Please furnish a print or sketch of your needs with your inquiry.
- Fittings are available in bulk quantities on request. Contact your sales representative for details.



PART NO.	UPC	DESCRIPTION	FINISH	QTY	LBS
----------	-----	-------------	--------	-----	-----

45° Oil Tank Valves

OVF45-6-8	○ 026613078670	3/8" OD Flare x 1/2" MIP	Rough	10	2.7
OVF45-6-12	○ 026613078663	3/8" OD Flare x 3/4" MIP	Rough	10	2.9



Drain Cocks

V601-2	○ 026613078762	1/8" MIP	Rough	25	3.8
V601-4	○ 026613078779	1/4" MIP	Rough	25	3.7
V601-6	○ 026613078786	3/8" MIP	Rough	25	7.8



Drain Cocks (External Seal)

DC604-2	○ 026613078236	1/8" MIP	Rough	25	0.8
DC604-4	○ 026613078243	1/4" MIP	Rough	25	1.0
DC604-6	○ 026613078250	3/8" MIP	Rough	25	.01



Female Drain Cocks

FF209-2	○ 026613078267	1/8" FIP, Both Ends	Rough	25	5.8
FF209-4	○ 026613078274	1/4" FIP, Both Ends	Rough	25	5.0
FF209-6	○ 026613078281	3/8" FIP, Both Ends	Rough	25	12.0



Female Male Drain Cocks

V402-2	○ 026613078724	1/8" FIP x 1/8" MIP	Rough	10	2.2
V402-4	○ 026613078731	1/4" FIP x 1/4" MIP	Rough	25	4.7
V402-6	○ 026613078755	3/8" FIP x 3/8" MIP	Rough	25	10.5



Male Drain Cocks

V401-2	○ 026613078694	1/8" MIP, Both Ends	Rough	25	2.5
V401-4	○ 026613078700	1/4" MIP, Both Ends	Rough	25	5.0



○ Not for use in potable water applications.

Brass Needle & Humidifier Valves

Product Applications

- For use on instrumentation, hydraulic and pneumatic systems.
- Designed for automotive or industrial use. Not intended for natural gas, LPG, nuclear or aircraft applications.

Product Advantages

- BrassCraft® Needle Valves have metal-to-metal seats with fine thread adjustment.
- Provide positive sealing and flow adjustment up to the capacity of the valve.
- Backed by BrassCraft Mfg.'s 65 plus year history and reputation for quality and service.

How to Order

- Order valves by part number and product name.

Special Orders

- Special fitting configurations and sizes may be ordered. Please furnish a print or sketch of your needs with your inquiry
- Fittings are available in bulk quantities on request. Contact your sales representative for details.

Assembly Instructions

- Install with pressure against seat.
- Inspection of straight valve shows one opening is higher than the others.
- Pressure should always be directed against the seat in angle valves, not the stem threads.



PART NO.	USE	UPC	DESCRIPTION	FINISH	QTY	LBS
----------	-----	-----	-------------	--------	-----	-----

Cooler Adaptors

CA-44	○	026613078212	1/2" FIP x 1/2" MIP w/ 1/8" FIP Side Outlet	Rough	25	3.1
CA-45	○	026613078229	3/4" FIP x 3/4" MIP w/ 1/8" FIP Side Outlet	Rough	25	5.5



Cooler Drains

CD-1	○	026613051284	3/4" Male Hose Thread x 1/2" FIP	Rough	25	2.8
------	---	--------------	----------------------------------	-------	----	-----



Humidifier Valves - Ice Maker Kit

NV104-EE1 K1	○	026613078519	3/8" OD Comp x 3/8" OD Comp w/ 1/4" OD Comp	Rough	100	16.9
NV104-EE1X K1	▲	026613153223	3/8" OD Comp x 3/8" OD Comp w/1/4" OD Comp	Rough	100	16.9

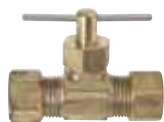

Compression Needle Valves

NV105-3	○	026613078526	3/16" OD Comp, Both Ends	Rough	25	2.1
NV105-4	○	026613078533	1/4" OD Comp, Both Ends	Rough	25	2.2
NV105-4X	▲	026613137490	1/4" OD Comp, Both Ends	Rough	25	2.2
NV105-6	○	026613078557	3/8" OD Comp, Both Ends	Rough	25	3.3
NV105-6X	▲	026613137483	3/8" OD Comp, Both Ends	Rough	25	3.1



NEV-NCV	○	026613078304	For 3/8" to 1" OD Tube w/ 1/4" OD Comp - Incl. Saddle Clamp, (2) Nuts, Bolts & Washers	Rough	100	24.2
---------	---	--------------	--	-------	-----	------

○ Not for use in potable water applications.

▲ Certified Compliant to NSF/ANSI 372 for potable water applications

PART NO.	USE	UPC	DESCRIPTION	FINISH	QTY	LBS
Compression x Iron Pipe Needle Valves						
NV106-3-2	○	026613078564	3/16" OD Comp x 1/8" MIP	Rough	25	1.8
NV106-4-2	○	026613078571	1/4" OD Comp x 1/8" MIP	Rough	25	1.9
NV106-4-4	○	026613078588	1/4" OD Comp x 1/4" MIP	Rough	25	2.4
NV106-6-4	○	026613078618	3/8" OD Comp x 1/4" MIP	Rough	10	1.8
NV104-4-2	○	026613078465	1/4" OD Comp x 1/8" MIP, Angle	Rough	25	1.7
NV104-4-2X	▲	026613150222	1/4" OD Comp x 1/8" MIP, Angle	Rough	25	1.7
NV104-4-4	○	026613078472	1/4" OD Comp x 1/4" MIP, Angle	Rough	25	3.3
NV104-5-2	○	026613078489	5/16" OD Comp x 1/8" MIP, Angle	Rough	25	2.4
NV104-5-2X	▲	026613150239	5/16" OD Comp x 1/8" MIP, Angle	Rough	25	2.4
NV104-6-4	○	026613078502	3/8" OD Comp x 1/4" MIP, Angle	Rough	10	1.5
NV106-4-2X	▲	026613150277	1/4" OD Comp x 1/8" MIP	Rough	25	1.9
NEV3-C1	○	026613078328	1/4" OD Comp x 1/8" MIP w/ Extension, Angle	Rough	10	0.7
NEV3-C1X	▲	026613150215	1/4" OD Comp x 1/8" MIP w/ Extension, Angle	Rough	10	0.7



Flare Needle Valves						
NV102-4	○	026613078380	1/4" OD Flare x 1/4" OD Flare	Rough	25	2.0
NV102-6	○	026613078397	3/8" OD Flare x 3/8" OD Flare	Rough	25	4.7
NV103-4-2	○	026613078403	1/4" OD Flare x 1/8" MIP	Rough	25	1.8
NV101-4-2	○	026613078335	1/4" OD Flare x 1/8" MIP, Angle	Rough	25	1.8
NV108-4	○	026613078656	1/4" FIP x 1/4" MIP	Rough	25	4.5



Self-Piercing Needle Valve Kits						
PNEV-NCV	○	026613078687	For 3/8" to 1" OD Tube w/1/4" OD Comp , Inc. Saddle Clamp w/Self-Locking Nuts, Brass Sleeve & Insert, & Delrin Sleeve	Rough	75	17.9
PNEV-NCVX	▲	026613137476	For 3/8" to 1" OD Tube w/1/4" OD Comp , Inc. Saddle Clamp w/Self-Locking Nuts, Brass Sleeve & Insert, & Delrin Sleeve	Rough	75	18.0



○ Not for use in potable water applications.
 ▲ Certified Compliant to NSF/ANSI 372 for potable water applications



PART NO.	USE	UPC	DESCRIPTION	FINISH	QTY	LBS
Self-Piercing Needle Valve Kits (cont.)						
BC96X	▲	026613148977	For 3/8" to 1" OD Tube w/1/4" OD Comp Incl. Saddle Clamp w/Self-Locking Nuts, 1/4" OD x 25' Polyethylene Tube, Brass Sleeve & Inserts & Delrin Sleeve, & 1/4" OD Union	Rough	5	3.5
BC97X	▲	026613148984	For 3/8" to 1" OD Tube w/1/4" OD Comp Incl. Saddle Clamp w/Self-Locking Nuts, 1/4" OD x 25' Copper Tube, Brass Sleeve & 1/4" OD Union	Rough	5	9.3

▲ Certified Compliant to NSF/ANSI 372 for potable water applications

PART NO.	UPC	DESCRIPTION	FINISH	QTY	LBS
Flare & Compression Fitting Cabinet					
DC800		Brass Fittings Cabinet		1	17.5



Flare & Compression Fitting Labels

BCFBL1287		Fitting Cabinet Labels 11 Sheets Per Set		1	.00
-----------	--	--	--	---	-----



FLARE FITTINGS

Use: For use with fuel, oil, liquefied petroleum (LP), and natural gas lines. Designed for use with aluminum, copper, brass, and welded steel tubing that can be flared.

Design Features:

- **Recommended for higher pressures** than those covered by compression fittings
- **Resist** mechanical pull out
- **Available in** a broad range of sizes
- **100% Compliant**



Operating Specifications:

Temperature: -65°- 250° F at maximum operating pressures

Working Pressure: See chart below

Vibration: Good vibration resistance*

*Recommend long flare nuts when greater vibration resistance is required

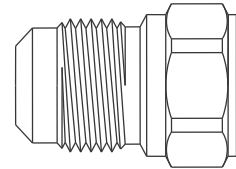
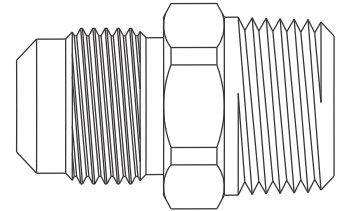
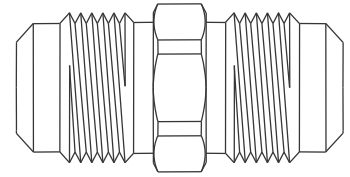

Standard Product

MATERIAL SPECIFICATIONS

Fitting Body	Brass
---------------------	-------

Compliant Product

MATERIAL SPECIFICATIONS

Fitting Body	Compliant brass
---------------------	-----------------

MAXIMUM WORKING PRESSURES

Service Conditions	Tube OD	Type of Tubing and Wall Thickness (Inches)									
		Copper – Dead Soft (Seamless)					Copper – Half Hard (Seamless)				
		.030"	.032"	.035"	.049"	.065"	.032"	.035"	.042"	.049"	.065"
Safety Factor 4-1	1/8	4300		5000			5000				
	3/16	2850		3300			3400				
	1/4	2100	2250	2500			2500				
	5/16		1800	2000			2000				
	3/8		1500	1650			1700	1850			
	1/2		1100	1250		2000	1250	1400			2600
	5/8			1000	1400	1800	1000			1500	2000
	3/4			850	1150	1500			1100		1700
	7/8									1100	1500
Safety Factor 6-1	1/8	2800		3350			3400				
	3/16	1900		2200			2250				
	1/4	1430	1500	1650			1700				
	5/16		1200	1300			1350				
	3/8		100	1100			1100	1200			
	1/2		750	825		1550	850	925			1750
	5/8			650	930	1200	675			1000	1350
	3/4			550	775	1000			725		1100
	7/8									750	1000

Listings & Certifications:

- Compliant product CSA listed to Low Lead Content Certification Program – Plumbing Products Class 6853-01



COMPRESSION FITTINGS

Use: For use with potable water, instrumentation, hydraulic, and pneumatic systems. Designed for use with aluminum, copper, and plastic tubing. Not intended for use with steel tubing.

* Plastic tubing requires a plastic insert and sleeve (see 60PT & 63PT).

Design Features:

- **Little to no tube preparation.** Compression fittings do not require flaring, soldering, or other types of tube preparation
- **Available in** a broad range of sizes
- **100%** Compliant product available 

Operating Specifications:

Temperature: -65° - 250° F at maximum operating pressures
Working Pressure: See chart below
Vibration: Fair vibration resistance

WORKING PRESSURE		
PSI	Tube O.D.	Tube Wall (Inches)
400	1/8	0.030
400	3/16	0.030
300	1/4	0.030
300	5/16	0.032
200	3/8	0.032
200	1/2	0.032
150	5/8	0.035
100	3/4	0.035
75	7/8	0.035

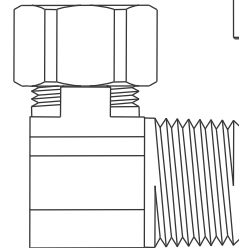
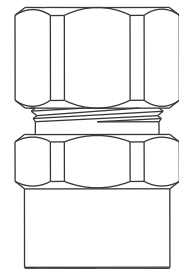
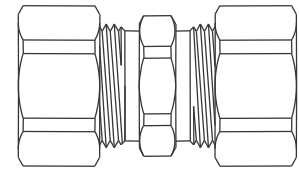

Standard Fitting

MATERIAL SPECIFICATIONS	
Fitting Body	Brass
Compression Sleeve	Brass
Compression Nut	Brass
Option	Chrome plating

Compliant Fitting

MATERIAL SPECIFICATIONS	
Fitting Body	Compliant brass
Compression Sleeve	Brass
Compression Nut	Brass

Listings & Certifications:

- Compliant product CSA listed to Low Lead Content Certification Program – Plumbing Products Class 6853-01



FITTINGS – BRASS CPVC TRANSITION

Use: For use with water, grease, fuels, LP and natural gas, refrigeration, instrumentation, and hydraulic systems in low and medium pressure pipe line connections. Use in combination with brass, copper, and iron pipe.

Design Features:

- **Designed & manufactured** to SAE (Society of Automotive Engineers) thread standards
- **Also meets** ASME and ASA requirements
- **Available in** a broad range of sizes
- **100% Compliant** product available 

Operating Specifications:

Temperature: See Catalog
Working Pressure: Up to 400 PSI – See Catalog
Vibration: Fair resistance to vibration and pipe movement depending on conditions

Standard Product

MATERIAL SPECIFICATIONS	
Fitting Body	Brass
CPVC Insert	CPVC
CPVC Washer	Rubber
CPVC Nut	Brass
Compression Sleeve	Brass
Compression Nut	Brass

Compliant Product

MATERIAL SPECIFICATIONS	
Fitting Body	Compliant brass
CPVC Insert	CPVC
CPVC Washer	Rubber
CPVC Nut	Brass
Compression Sleeve	Brass
Compression Nut	Brass

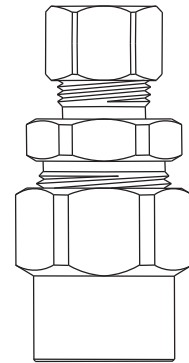

Standard Product

MATERIAL SPECIFICATIONS	
Fitting Body	Brass
CPVC Insert	CPVC
CPVC Washer	Rubber
CPVC Nut	Brass

Compliant Product

MATERIAL SPECIFICATIONS	
Fitting Body	Compliant brass
CPVC Insert	CPVC
CPVC Washer	Rubber
CPVC Nut	Brass

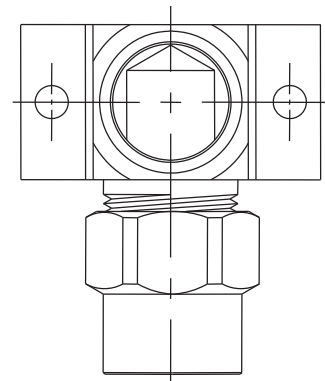

Listings & Certifications:

- Compliant product CSA listed to Low Lead Content Certification Program – Plumbing Products Class 6853-01



IRON PIPE FITTINGS

Use: For use with water, grease, fuels, LP and natural gas, refrigeration, instrumentation, and hydraulic systems in low and medium pressure pipe line connections. Use in combination with brass, copper, and iron pipe.

Design Features:

- **Designed and manufactured** to SAE (Society of Automotive Engineers) thread standards
- **Also meets** ASME and ASA requirements
- **Available in** a broad range of sizes
- **100%** Compliant product available 

Operating Specifications:

Temperature: -65° - 250° F
Working Pressure: 1200 PSI maximum
Vibration: Fair resistance to vibration and pipe movement depending on conditions

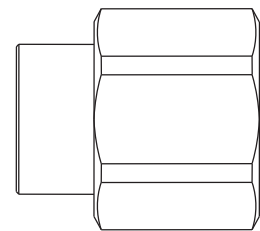
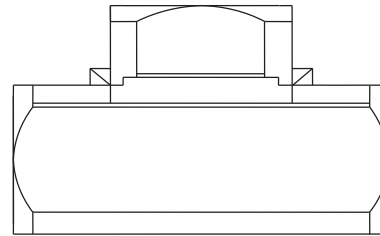

Standard Product

MATERIAL SPECIFICATIONS	
Machined Body	Brass
Forged Body	Brass

Compliant Product

MATERIAL SPECIFICATIONS	
Machined Body	Compliant brass
Forged Body	Compliant brass

Listings & Certifications:

- Compliant product CSA listed to Low Lead Content Certification Program – Plumbing Products Class 6853-01 

HOSE BARB FITTINGS

Use: For use with plastic or rubber tubing. Installation requires a hose clamp.

Design Features:

- **Manufactured with** dryseal pipe threads
- **Available in** a broad range of sizes, with swivel flare
- **100%** Compliant product available 

Operating Specifications:

Temperature: -40° - 160° F
Working Pressure: 150 PSI maximum

Standard Product

MATERIAL SPECIFICATIONS	
Fitting body	Brass
Nut (if applicable)	Brass

Compliant Product

MATERIAL SPECIFICATIONS	
Fitting body	Compliant brass
Nut (if applicable)	Brass

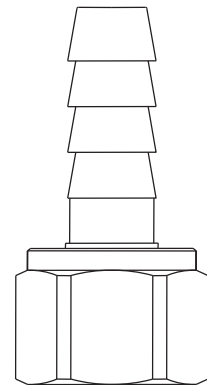
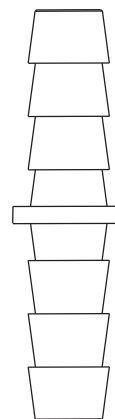

Listings & Certifications:

- Compliant product CSA listed to Low Lead Content Certification Program – Plumbing Products Class 6853-01 

NIPPLES – BRASS PIPE

Use: For use with water, grease, fuels, LP and natural gas, refrigeration, instrumentation, and hydraulic systems in low and medium pressure pipe line connections. Use in combination with brass, copper, and iron pipe.

Design Features:

- **Designed & manufactured** to SAE (Society of Automotive Engineers) thread standards
- **Also meets** ASME and ASA requirements
- **Available** in a broad range of sizes
- **100%** Compliant product available 

Operating Specifications:

Temperature: -65° - 250° F
Working Pressure: Up to 1200 PSI
Vibration: Fair resistance to vibration and pipe movement depending on conditions

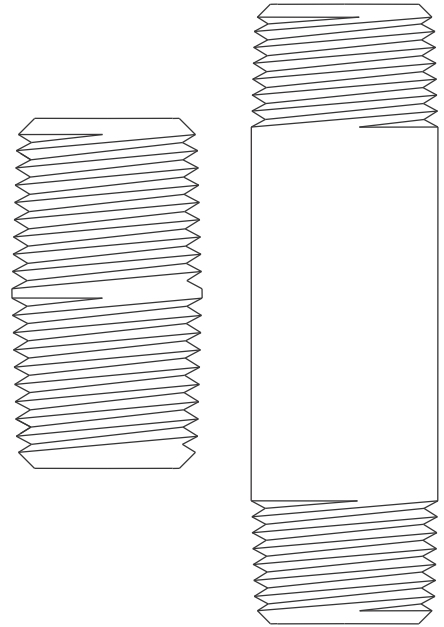

MATERIAL SPECIFICATIONS

Nipple	<i>Yellow or Compliant brass</i>
---------------	----------------------------------

Listings & Certifications:

- Compliant product CSA listed to Low Lead Content Certification Program – Plumbing Products Class 6853-01



GARDEN HOSE FITTINGS

Use: For use with residential and commercial grade garden hose. All female hose thread connections require a rubber washer inserted prior to installation.

Design Features:

- Available in a broad range of configurations
- 100% Compliant 

Operating Specifications:

Temperature: -35° - 100°F at maximum operating pressures
Working Pressure: 75 PSI maximum, intermittent to 150 PSI

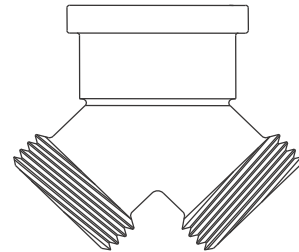
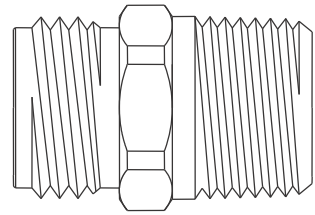
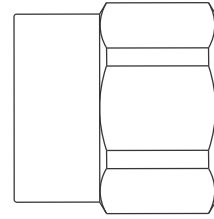

Standard Product

MATERIAL SPECIFICATIONS	
Fitting Body	Brass
Hose Washer	Rubber

Compliant Product

MATERIAL SPECIFICATIONS	
Fitting Body	Compliant brass
Hose Washer	Rubber

Listings & Certifications:

- Compliant product CSA listed to Low Lead Content Certification Program – Plumbing Products Class 6853-01



GAS FITTINGS

Use: For use with natural, manufactured, mixed, liquefied petroleum gases and LP gas-air mixtures.

Design Features:

- **One-piece body** provides strength, durability, and long-lasting performance
- **Manufactured with dryseal pipe threads.**

Operating Specifications:

Temperature: -40° - 150° F

Pressure: 1/2 PSI maximum

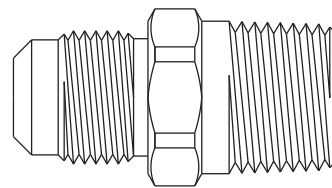
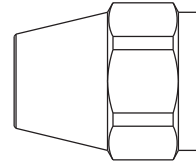
**MATERIAL SPECIFICATIONS**

Brass Fitting	Brass
Steel Fitting	Blue zinc plated steel

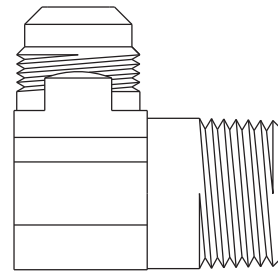
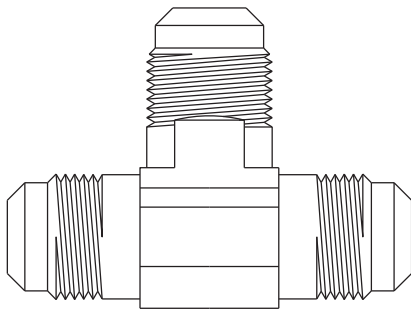
**Listings & Certifications:**

- For use with CSA listed ANSI Z21.24 / CSA 6.10 connectors
- For use with CSA listed ANSI Z21.75 / CSA 6.27 connectors

DRAIN COCKS

Use: For use with low pressure air, water, gas, and fluids (lubricant may not be compatible with some fluids)

Design Features:

- **Forged one-piece brass body** provides strength, durability, and long-lasting performance
- **Brass handle** provides a secure grip and smooth on/off operation
- **Manufactured with dryseal pipe threads**

Operating Specifications:

Temperature: 32° - 125° F
Working Pressure: 60 PSI

Standard

MATERIAL SPECIFICATIONS	
Valve Body	Brass
Handle/Stem	Brass
Handle Screw	Steel
Spring	Steel
Washer	Steel

Listings & Certifications:

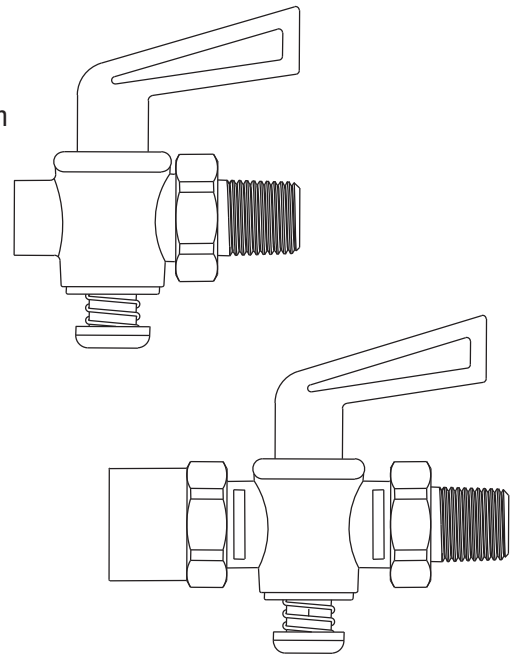

NEEDLE & HUMIDIFIER VALVES

Use: For use with automotive & industrial applications for instrumentation, hydraulic and pneumatic systems. Not intended for use with natural gas, LPG (liquefied petroleum gas or propane), nuclear, or avionic (aircraft) applications

Design Features:

- **Positive sealing & flow adjustment** up to the capacity of the valve
- **Metal-to-metal seats** with a fine thread engagement
- **100% Compliant product available**



Operating Specifications:

Temperature: -65° - 250° F
Water applications 40° - 140° F, 115° F maximum continuous use temperature
Working Pressure: 150 PSI maximum

Standard

MATERIAL SPECIFICATIONS	
Valve Body	Brass
Stem	Brass
Handle	Steel
Nut	Brass
Rubber Washer	Rubber
Compression Ring	Brass

Compliant

MATERIAL SPECIFICATIONS	
Valve Body	Compliant brass
Stem	Compliant brass
Handle	Steel
Nut	Brass
Rubber Washer	Rubber
Compression Ring	Brass

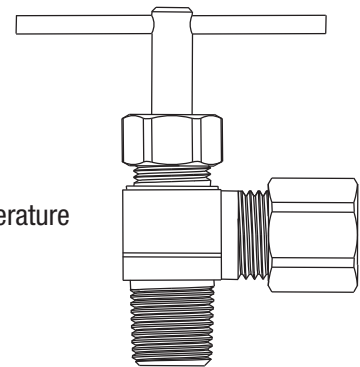

Listings & Certifications:

- Compliant product CSA listed to Low Lead Content Certification Program – Plumbing Products Class 6853-01



PART NO.	PAGE	PART NO.	PAGE	PART NO.	PAGE
10 C	24	113-06-4-RX	33	119-6-4	29
10 R	24	113-06-5.5-CX	33	119-6-4X	29
102-12	34	113-06-5-CX	33	119-8-2	29
102-2	34	113-06-6-CX	33	119-8-4	29
102-4	34	113-08-1.5-CX	33	119-8-4X	29
102-6	34	113-08-1.5-RX	33	119-8-6	29
102-8	34	113-08-2.5-CX	33	119-8-6X	29
104-12	29	113-08-2.5-RX	33	11X C	24
104-4	29	113-08-2-CX	33	11X R	24
104-6	29	113-08-2-RX	33	12 C	25
104-8	29	113-08-3.5-CX	33	12 R	25
10X C	24	113-08-3.5-RX	33	120-12	30
11 C	24	113-08-3-CX	33	120-12-6	30
11 R	24	113-08-3-RX	33	120-12-8	30
112-02-RX	32	113-08-4.5-CX	33	120-12-8X	30
112-04-RX	32	113-08-4-CX	33	120-2	30
112-06-CX	32	113-08-4-RX	33	120-2X	30
112-06-RX	32	113-08-5.5-CX	33	120-4	30
112-08-CX	32	113-08-5.5-RX	33	120-4-2	30
112-08-RX	32	113-08-5-CX	33	120-4-2X	30
112-12-RX	32	113-08-5-RX	33	120-4X	30
112-16-RX	32	113-08-6-CX	33	120-6	30
113-02-1.5-RX	32	113-08-6-RX	33	120-6-2	30
113-02-2.5-RX	32	113-12-1.5-RX	33	120-6-2X	30
113-02-2-RX	32	113-12-2.5-RX	33	120-6-4	30
113-02-3.5-RX	32	113-12-2-CX	33	120-8	30
113-02-3-RX	32	113-12-2-RX	33	120-8-4	30
113-02-4-RX	32	113-12-3.5-RX	33	120-8-4X	30
113-04-1.5-RX	32	113-12-3-RX	33	120-8-6	30
113-04-2.5-RX	32	113-12-4.5-CX	34	120-8-6X	30
113-04-2-RX	32	113-12-4-RX	33	120-8X	30
113-04-3.5-RX	32	113-12-5-RX	34	125-10-12	37
113-04-3-RX	32	113-12-6-RX	34	125-10-6	37
113-04-4-RX	33	113-16-2-RX	34	125-10-6X	37
113-04-6-RX	33	113-16-3-RX	34	125-10-8	37
113-06-1.5-CX	33	113-16-4-RX	34	125-10-8X	37
113-06-1.5-RX	33	113-16-6-RX	34	125-12-12	37
113-06-2.5-CX	33	114FSV-10	12	125-12-12X	37
113-06-2.5-RX	33	114FSV-4	12	125-12-8	37
113-06-2-CX	33	114FSV-5	12	125-12-8X	37
113-06-2-RX	33	114FSV-6	12	125-16-12	37
113-06-3.5-CX	33	114FSV-8	12	125-16-12X	37
113-06-3-CX	33	119-12-8	29	125-16-16	37
113-06-3-RX	33	119-12-8X	29	125-16-16X	37
113-06-4.5-CX	33	119-4-2	29	125-2-2	36
113-06-4-CX	33	119-6-2	29	125-2-2X	36

PART NO.	PAGE	PART NO.	PAGE	PART NO.	PAGE
125-2-4.....	36	126-6-6.....	35	141L-8.....	11
125-2-4X.....	36	126-6-6X.....	35	141S-10.....	11
125-3-2.....	36	126-6-8.....	36	141S-10-8.....	11
125-3-2X.....	36	126-8-4.....	36	141S-12.....	11
125-3-4.....	36	126-8-6.....	36	141S-14.....	11
125-3-4X.....	36	126-8-8.....	36	141S-4.....	11
125-4-2.....	36	126-8-8X.....	36	141S-5.....	11
125-4-2X.....	36	127-4-2.....	37	141S-6.....	11
125-4-4.....	36	127-4-4.....	37	141S-6-4.....	11
125-4-4X.....	36	127-8-8.....	37	141S-8.....	11
125-4-6.....	36	128-12-12.....	37	141S-8-6.....	11
125-4-6X.....	36	128-4-4.....	37	144-10.....	13
125-4-8.....	36	128-4-4X.....	37	144-10-10-6.....	13
125-4-8X.....	36	128-6-4.....	37	144-10-10-8.....	13
125-5-2.....	36	128-6-6.....	37	144-4.....	13
125-5-2X.....	36	128-8-6.....	37	144-5.....	13
125-5-4.....	36	128-8-8.....	37	144-6.....	13
125-5-4X.....	36	129-10-6.....	38	144-6-6-4.....	13
125-5-6.....	36	129-10-8.....	38	144-8.....	13
125-6-2.....	36	129-4-2.....	37	144-8-6-6.....	13
125-6-2X.....	36	129-4-4.....	37	144-8-6-8.....	13
125-6-4.....	36	129-4-4X.....	37	144-8-8-10.....	13
125-6-4X.....	36	129-5-2.....	37	144-8-8-6.....	13
125-6-6.....	36	129-5-4.....	37	145-10-8.....	13
125-6-6X.....	36	129-5-6.....	37	145-3-2.....	13
125-6-8.....	36	129-6-2.....	37	145-4-2.....	13
125-6-8X.....	36	129-6-4.....	38	145-4-4.....	13
125-8-12.....	36	129-6-6.....	38	145-6-4.....	13
125-8-4.....	36	129-6-6X.....	38	145-6-6.....	13
125-8-4X.....	36	129-8-4.....	38	145-6-8.....	13
125-8-6.....	36	129-8-6.....	38	145-8-6.....	13
125-8-6X.....	36	129-8-8.....	38	145-8-8.....	13
125-8-8.....	36	12X C.....	25	146-4-4.....	37
125-8-8X.....	36	12X R.....	25	146-4-4X.....	37
126-12-12.....	36	136-6-8.....	13	146-4-6.....	37
126-2-2.....	35	139-4-2.....	38	146-6-6.....	37
126-3-2.....	35	139-6-4.....	38	146-6-6X.....	37
126-4-2.....	35	139-6-6.....	38	146-6-8.....	37
126-4-2X.....	35	139-8-4.....	38	146-6-8X.....	37
126-4-4.....	35	139-8-6.....	38	146-8-8.....	37
126-4-4X.....	35	13X C.....	19	149-10-12.....	12
126-5-2.....	35	13X R.....	19	149-10-4.....	12
126-5-4.....	35	14 C.....	24	149-10-6.....	12
126-6-2.....	35	14 R.....	24	149-10-8.....	12
126-6-4.....	35	141L-10.....	11	149-12-12.....	11
126-6-4X.....	35	141L-6 B.....	11	149-12-8.....	12

PART NO.	PAGE	PART NO.	PAGE	PART NO.	PAGE
149-2-2.....	11	159-10-8.....	12	202-2.....	31
149-3-2.....	11	159-4-2.....	12	202-2X.....	31
149-4-2.....	11	159-4-4.....	12	202-4.....	31
149-4-4.....	11	159-6-4.....	12	202-4X.....	31
149-4-6.....	11	159-6-6.....	12	202-6.....	31
149-4-8.....	12	159-8-6.....	12	202-6X.....	31
149-5-2.....	12	19 C.....	24	202-8.....	31
149-5-4.....	12	19 R.....	24	202-8X.....	31
149-6-12.....	12	190A.....	43	202A.....	44
149-6-2.....	12	190B.....	43	202D.....	44
149-6-4.....	12	190C.....	43	203-12.....	34
149-6-6.....	11	191B.....	43	203-2.....	34
149-6-8.....	12	191C.....	43	203-2X.....	34
149-8-12.....	12	192A.....	43	203-4.....	34
149-8-4.....	12	192B.....	43	203-4X.....	34
149-8-6.....	12	192C.....	43	203-6.....	34
149-8-8.....	11	193A.....	43	203-6X.....	34
14X C.....	24	193B.....	43	203-8.....	34
14X R.....	24	193C.....	43	203-8X.....	34
150-10-12.....	11	196A.....	44	203A.....	44
150-10-6.....	11	196B.....	44	204C.....	44
150-10-8.....	11	196C.....	44	205-12.....	31
150-4-2.....	11	197A.....	43	205-2.....	31
150-4-4.....	11	197B.....	43	205-4.....	31
150-4-6.....	11	197C.....	43	205-6.....	31
150-5-4.....	11	197D.....	43	205-8.....	31
150-6-12.....	11	198A.....	44	207-12.....	29
150-6-4.....	11	198B.....	44	207-12X.....	29
150-6-6.....	11	198D.....	44	207-2.....	29
150-6-8.....	11	199A.....	44	207-2X.....	29
150-8-12.....	11	199B.....	44	207-4.....	29
150-8-6.....	11	19X C.....	24	207-4X.....	29
150-8-8.....	11	200-12.....	31	207-6.....	29
151-10-8.....	13	200-2.....	31	207-6X.....	29
151-4-2.....	13	200-2X.....	31	207-8.....	29
151-4-4.....	13	200-4.....	31	207-8X.....	29
151-6-4.....	13	200-4X.....	31	210-2.....	29
151-6-6.....	13	200-6.....	31	210-4.....	29
151-8-8.....	13	200-6X.....	31	210-6.....	29
152-8.....	13	200-8.....	31	210-8.....	29
155-10.....	12	200-8X.....	31	211-12.....	28
155-10-8.....	12	200A.....	44	211-2.....	28
155-4.....	12	200B.....	44	211-2X.....	28
155-6.....	12	200C.....	44	211-4.....	28
155-8.....	12	202-12.....	31	211-4X.....	28
155-8-6.....	12	202-12X.....	31	211-6.....	28

PART NO.	PAGE	PART NO.	PAGE	PART NO.	PAGE
211-6X	28	39-5	6	44-10-10-8	9
211-8	28	39-6	6	44-10-6-6	9
211-8X	28	39-8	6	44-3	9
213-12	29	40-10	6	44-4	9
213-2	29	40-3	6	44-5	9
213-2X	29	40-4	6	44-6	9
213-4	29	40-5	6	44-6-6-8	9
213-6	29	40-6	6	44-8	9
213-6X	29	40-6X	6	44-8-6-6	9
213-8	29	40-8	6	44-8-6-8	9
219-2X	28	41L-10	6	44-8-8-6	9
219-4X	28	41L-4	6	46-10-12	7
219-6X	28	41L-5	6	46-10-6	7
219-8X	28	41L-6	6	46-10-8	7
224-2	31	41L-8	6	46-12-12	7
224-2X	31	41S-10	6	46-12-8	7
224-4	31	41S-12	6	46-14-12	7
224-4X	31	41S-14	6	462-6-4	24
224-6	31	41S-2	6	462-6-4X	24
224-6X	31	41S-3	6	462-6-6	24
224-8	31	41S-4	6	462-6-6X	24
224-8X	32	41S-5	6	462-8-6	24
225-2	34	41S-6	6	462-8-6X	24
225-2X	34	41S-6X	6	46-3-2	7
225-4	34	41S-7	6	46-4-2	7
225-4X	34	41S-8	6	46-4-4	7
225-6	34	41S-8X	6	46-4-6	7
225-6X	34	42-10	7	46-4-8	7
225-8	34	42-10-6	7	46-5-4	7
226-12	34	42-10-8	7	46-6-12	7
226-2	34	42-12	7	46-6-2	7
226-4	34	42-12-10	7	46-6-4	7
226-4X	34	42-12-8	7	46-6-6	7
226-6	34	42-14	7	46-6-8	7
226-8	34	42-2	6	46-8-12	7
24 R	24	42-3	6	46-8-4	7
24X R	24	42-4	6	46-8-6	7
30 C	25	42-5	6	46-8-8	7
32 C	24	42-5-4	7	48-10-12	8
33 C	24	42-6	7	48-10-4	8
33X C	25	42-6-4	7	48-10-6	8
34 C	25	42-6-5	7	48-10-8	8
34 R	25	42-8	7	48-12-12	8
38C-10-8	21	42-8-4	7	48-12-8	8
39-10	6	42-8-6	7	48-14-12	8
39-4	6	44-10	9	48-2-2	7

PART NO.	PAGE	PART NO.	PAGE	PART NO.	PAGE
48-3-2.....	8	60-4.....	16	62-14.....	17
48-3-4.....	8	60-5.....	16	62-14DT.....	17
48-4-2.....	8	60-6.....	16	62-14X.....	17
48-4-4.....	7	60-7.....	16	62-2.....	17
48-4-6.....	8	60-8.....	16	62-3.....	17
48-4-8.....	8	60PT-10.....	26	62-4.....	17
48-5-2.....	8	60PT-4.....	26	62-4-2.....	17
48-5-4.....	8	60PT-5.....	26	62-4-3.....	17
48-5-6.....	8	60PT-6.....	26	62-4DT.....	17
48-6-12.....	8	60PT-8.....	26	62-4DTX.....	17
48-6-2.....	8	61-10.....	16	62-4X.....	17
48-6-4.....	8	61-12.....	16	62-5.....	17
48-6-6.....	7	61-14.....	16	62-5-4.....	17
48-6-8.....	8	61-2.....	16	62-6.....	17
48-8-12.....	8	61-3.....	16	62-6-4.....	17
48-8-4.....	8	61-4.....	16	62-6-4X.....	17
48-8-6.....	8	61-5.....	16	62-6-5.....	17
48-8-8.....	8	61-6.....	16	62-6DT.....	17
49-10-8.....	9	61-7.....	16	62-6DTX.....	17
49-3-2.....	8	61-8.....	16	62-6X.....	17
49-4-2.....	8	61CA-2.....	26	62-6X C.....	17
49-4-4.....	8	61CA-3 B.....	26	62-7.....	17
49-4-6.....	8	61CA-4.....	26	62-8.....	17
49-5-2.....	8	61CA-5.....	26	62-8-6.....	17
49-5-4.....	9	61CA-6.....	26	62-8-6 C.....	17
49-6-2.....	9	61CA-8.....	26	62-8-6X.....	18
49-6-4.....	9	61CP-10.....	16	62-8DT.....	17
49-6-6.....	8	61CP-10X.....	16	62-8X.....	17
49-6-8.....	9	61CP-4.....	16	62BH-4.....	24
49-8-4.....	9	61CP-4X.....	16	62BH-6.....	24
49-8-6.....	9	61CP-6.....	16	62CA-4.....	26
49-8-8.....	8	61CP-6X.....	16	62H-4-12.....	40
50-10-12.....	8	61CP-8.....	16	62H-4-12X.....	40
50-10-8.....	8	61CP-8X.....	16	63PT-10X.....	26
50-6-6.....	8	61L-12.....	17	63PT-4X.....	26
50-6-8.....	8	61L-4.....	17	63PT-5X.....	26
55-10.....	9	61L-6.....	17	63PT-6X.....	26
55-3 B.....	9	62-10.....	17	63PT-8X.....	26
55-4.....	9	62-10-6.....	18	64-10.....	23
55-6.....	9	62-10-6X.....	18	64-10X.....	23
55-8.....	9	62-10-8.....	18	64-2.....	22
60-10.....	16	62-10-8X.....	18	64-3.....	22
60-12.....	16	62-10DT.....	17	64-4.....	22
60-14.....	16	62-10DTX.....	17	64-4X.....	22
60-2.....	16	62-10X.....	17	64-5.....	23
60-3.....	16	62-12.....	17	64-6.....	23

PART NO.	PAGE	PART NO.	PAGE	PART NO.	PAGE
64-6-6-4	23	66-4-8	18	68-5-4	19
64-6-6-4X	23	66-4-8X	18	68-5-6	19
64-6X	23	66-5-4	18	68-6-12	19
64-6X C	23	66-5-6	18	68-6-12X	19
64-8	23	66-6-12	18	68-6-2	19
64-8-8-6	23	66-6-2	18	68-6-2X	19
64-8X	23	66-6-2X	18	68-6-4	19
65-10	20	66-6-4	18	68-6-4X	19
65-10-6	20	66-6-4X	18	68-6-4X C	19
65-10-6 C	20	66-6-6	18	68-6-6	19
65-10-6X	20	66-6-6X	18	68-6-6X	19
65-10-6X C	20	66-6-8	18	68-6-6X C	19
65-10-8	20	66-6-8 C	18	68-6-8	19
65-10X	20	66-6-8X	18	68-6-8X	19
65-14	20	66-6-8X C	18	68-6-8X C	19
65-14X	20	66-8-12	18	68-7-4	20
65-2	20	66-8-4	18	68-7-4X	20
65-3	20	66-8-6	18	68-7-6	20
65-4	20	66-8-6X	18	68-8-12	20
65-4X	20	66-8-8	18	68-8-12X	20
65-5	20	66-8-8X	18	68-8-4	20
65-6	20	68-10-12	20	68-8-4X	20
65-6 C	20	68-10-12X	20	68-8-6	20
65-6X	20	68-10-6	20	68-8-6X	20
65-8	20	68-10-8	20	68-8-8	19
65-8-6	20	68-10-8X	20	68-8-8X	19
65-8X	20	68-12-12	19	68-8DT	19
66-10-12	18	68-12-8	20	68-8DTX	19
66-10-12X	19	68-14-12	20	68CA-4-2	26
66-10-6	18	68-14-12X	20	68CA-4-4	26
66-10-6X	18	68-14-16	20	69-10-12	22
66-10-8	18	68-14-16X	20	69-10-6	22
66-10-8X	18	68-14-8	20	69-10-8	22
66-12-12	18	68-14-8X	20	69-10-8X	22
66-12-8	19	68-2-2	19	69-14-12	22
66-14-12	19	68-3-2	19	69-2-2	21
66-14-12X	19	68-3-4	19	69-2-2X	21
66-2-2	18	68-4-2	19	69-3-2	22
66-3-2	18	68-4-2X	19	69-3-4	22
66-3-4	18	68-4-4	19	69-4-2	22
66-4-2	18	68-4-4X	19	69-4-2X	22
66-4-2X	18	68-4-6	19	69-4-4	21
66-4-4	18	68-4-6X	19	69-4-4X	21
66-4-4X	18	68-4-8	19	69-4-6	22
66-4-6	18	68-4-8X	19	69-4-6X	22
66-4-6X	18	68-5-2	19	69-5-2	22

PART NO.	PAGE	PART NO.	PAGE	PART NO.	PAGE
69-5-4.....	22	70-6-6 C	21	90R	43
69-5-6.....	22	70-6-6X.....	21	94D	42
69-5-8.....	22	70-6-8.....	21	96.....	43
69-6-12.....	22	70-6-8 C	21	96A	42
69-6-2.....	22	70-6-8X.....	21	96B	42
69-6-2X.....	22	70-6-8X C	21	96BR	43
69-6-4.....	22	70-8-6.....	21	96C	42
69-6-4 C	22	70-8-8.....	21	96D	42
69-6-4X.....	22	70-8-8 C	21	96L.....	43
69-6-6.....	21	71-4-2.....	23	96P.....	43
69-6-6 C	21	71-4-2X.....	23	96R	43
69-6-6X.....	21	71-4-4.....	23	97B	42
69-6-6X C	21	71-6-4.....	23	ASN-10.....	10
69-6-8.....	22	71-6-4X.....	23	AU1-14-12	10
69-6-8 C	22	71-6-6.....	23	AU1-14-16	10
69-6-8X.....	22	72-10-8.....	23	AU1-6-8S.....	10
69-6-8X C	22	72-2-2.....	23	AU1-6S.....	10
69-7-4.....	22	72-3-2.....	23	AU1-8-12S	10
69-7-6.....	22	72-4-2.....	23	AU1-8S.....	10
69-8-4.....	22	72-4-2X.....	23	AU2-14-12	10
69-8-4X.....	22	72-4-4.....	23	AU2-14-16	10
69-8-6.....	22	72-4-4X.....	23	AU2-6-8S	10
69-8-6 C	22	72-5-2.....	23	AU2-6S.....	10
69-8-6X.....	22	72-6-2.....	23	AU2-8-12S	10
69-8-6X C	22	72-6-4.....	23	AU2-8-6S	10
69-8-8.....	21	72-6-6.....	23	AU2-8S.....	10
69-8-8 C	22	72-6-6X.....	23	BC96X	48
69-8-8X.....	21	72-8-6.....	23	BC97X	48
69CA-4-2	26	72-8-8.....	23	BCFBL1287	49
70-10-12.....	21	73-3	35	C14 C	25
70-10-8.....	21	73-3X	35	C14 R	25
70-10-8X.....	21	73-4	35	C14X C	25
70-2-2.....	21	73-4X	35	C34 C	25
70-3-2.....	21	73-5.....	35	C34 R	25
70-4-2.....	21	73-5X.....	35	CA-44.....	46
70-4-2X.....	21	73-6.....	35	CA-45.....	46
70-4-4.....	21	73-6X.....	35	CD-1.....	46
70-4-4X.....	21	73-8.....	35	CSP-10.....	16
70-4-8.....	21	73-8X.....	35	CSP-10X.....	16
70-5-2.....	21	90.....	43	CSP-4.....	16
70-5-2X.....	21	90A	42	CSP-4X.....	16
70-5-4.....	21	90B	42	CSP-6.....	16
70-6-2.....	21	90BR	43	CSP-6X.....	16
70-6-4.....	21	90C	42	CSP-8.....	16
70-6-4X.....	21	90D	42	CSP-8X.....	16
70-6-6.....	21	90P.....	43	CT1-662.....	23

PART NO.	PAGE	PART NO.	PAGE	PART NO.	PAGE
CT2-664X P	23	HU125-10-12	41	NV101-4-2	47
CT2-666X P	23	HU125-10-12X	41	NV102-4	47
DC604-2	45	HU125-12-12	41	NV102-6	47
DC604-4	45	HU125-12-12X	41	NV103-4-2	47
DC604-6	45	HU125-8-12	41	NV104-4-2	47
DC800	49	HU125-8-12X	41	NV104-4-2X	47
F0-6	14	HU126-10-12	40	NV104-4-4	47
F0-6 C	14	HU126-10-12H	41	NV104-5-2	47
F0-6-4 C	14	HU126-10-12HX	41	NV104-5-2X	47
F0-6-4 R	14	HU126-10-12X	40	NV104-6-4	47
F0-8	14	HU126-12-12	40	NV104-EE1 K1	46
F0-8 C	14	HU126-12-12H	41	NV104-EE1X K1	46
F10-6	14	HU126-12-12X	40	NV105-3	46
F12-6-8	14	HU126-8-12	40	NV105-4	46
FB-5	6	HU126-8-12H	41	NV105-4X	46
FB-6	6	HU126-8-12HX	41	NV105-6	46
FB-8	6	HU126-8-12X	40	NV105-6X	46
FC-6	14	HU12-8-12	39	NV106-3-2	47
FF209-2	45	HU12-8-12X	39	NV106-4-2	47
FF209-4	45	HU21-12-12	40	NV106-4-2X	47
FF209-6	45	HU21-12-12X	40	NV106-4-4	47
FRC11-6	14	HU21-8-12	40	NV106-6-4	47
FRC13-6-8	14	HU21-8-12X	40	NV108-4	47
FRC16-6	14	HU22-12-12	39	OVF45-6-12	45
FRC18-6-8	14	HU22-12-12TP	40	OVF45-6-8	45
FT3-6	14	HU22-12-12TPX	40	P14C C	27
FU3-6	14	HU22-12-12X	40	P14C R	27
HBT1-664	38	HU22-12MH	39	P14CX R	27
HBT2-6	38	HU22-12MHX	39	P19C C	27
HBT2-6X	38	HU22-8-12	39	P44C R	27
HC-1	39	HU22-8-12X	39	P44CX R	27
HC-1X	39	HUS11-12-12	40	P48F R	27
HC-8	39	HUS11-12-12X	40	P48FX R	27
HES-6-12	41	HUS11-8-12	40	P48M C	27
HES-6-12WNM	41	HUS11-8-12X	40	P48M R	27
HES-8-12	41	HUS-12	39	P48MX R	27
HFU21-6-12	40	HUS-12X	39	P48W R	27
HFU22-6-12	40	M40-10	10	P48WX R	27
HFU22-8-12	40	MAE1-10-12	10	P72F R	27
HNR-1	39	MAU1-10-12S	10	P72FX R	27
HU11-12-12	40	MAU1-10-8S	10	P72M R	27
HU11-12-12X	40	MAU2-10-12S	10	P72MX R	27
HU11-8-12	40	MAU2-10-8S	10	P77C R	27
HU11-8-12X	40	NEV3-C1	47	PHN-12	32
HU12-12-12	39	NEV3-C1X	47	PHN-12X	32
HU12-12-12X	39	NEV-NCV	46	PHN-2	32

PART NO.	PAGE	PART NO.	PAGE	PART NO.	PAGE
PHN-2X.....	32	PSA-12X.....	31		
PHN-4.....	32	PSA-16.....	31		
PHN-4-2.....	32	PSA-16X.....	31		
PHN-4-2X.....	32	PSA-8.....	31		
PHN-4X.....	32	PSA-8X.....	31		
PHN-6.....	32	TS-6X.....	26		
PHN-6-2.....	32	TS-8X.....	26		
PHN-6-4.....	32	V401-2.....	45		
PHN-6X.....	32	V401-4.....	45		
PHN-8.....	32	V402-2.....	45		
PHN-8-4.....	32	V402-4.....	45		
PHN-8-4X.....	32	V402-6.....	45		
PHN-8-6.....	32	V601-2.....	45		
PHN-8-6X.....	32	V601-4.....	45		
PHN-8X.....	32	V601-6.....	45		
PNEV-NCV.....	47	Y-9.....	41		
PNEV-NCVX.....	47				
PPH-12.....	28				
PPH-2.....	28				
PPH-2X.....	28				
PPH-4.....	28				
PPH-4X.....	28				
PPH-6.....	28				
PPH-6X.....	28				
PPH-8.....	28				
PPH-8X.....	28				
PRB-12-2.....	30				
PRB-12-4.....	30				
PRB-12-4X.....	30				
PRB-12-6.....	30				
PRB-12-8.....	30				
PRB-12-8X.....	30				
PRB-16-12.....	30				
PRB-4-2.....	30				
PRB-4-2X.....	30				
PRB-6-2.....	30				
PRB-6-2X.....	30				
PRB-6-4.....	30				
PRB-6-4X.....	30				
PRB-8-2.....	30				
PRB-8-2X.....	30				
PRB-8-4.....	30				
PRB-8-4X.....	30				
PRB-8-6.....	30				
PRB-8-6X.....	30				
PSA-12.....	31				

Distributed by:

Committed to Quality, Driven by Innovation.

For product availability please refer to "Wholesale 2013 Compliant Conversion Plan - Product Availability List" on ROA.
Product offering and availability are subject to change. Please contact BrassCraft Customer Service toll-free
at 877-272-7755 for verification or ROA access.



BrassCraft®

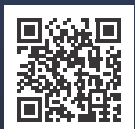

Scan for direct
access to the
BrassCraft®
Brass Fittings
List Price
Schedule

BrassCraft Manufacturing Co.
39600 Orchard Hill Place
Novi, Michigan 48375-5331
TOLL-FREE: (877) 272-7755
FAX: (248) 305-6011

350 South Edgeware Road
St. Thomas, Ontario Canada N4P 4C4
TOLL-FREE: (800) 265-4322
FAX: (800) 567-9100