

IRWIN®

Wood Drilling













www.irwin.com

A Century of Quality and Innovation

In 1885, the IRWIN® Auger Bit Company was formed. Over 125 years later, IRWIN is still the leading manufacturer of wood drilling bits and accessories. No matter what wood drilling project you face, IRWIN Tools makes a drill bit that performs the job better. Our mark of quality is stamped right on the shank of our full range of bits. Whether the job requires quick, clean holes or precise finish work, IRWIN has a bit for every application and every need.

The all new IRWIN® WeldTec™ pole auger is made stronger and lasts longer than any pole auger in the market. It features a welded high speed steel cutting edge that is sharper and larger than standard carbon steel pole augers, providing increased durability and faster drilling in dense, treated, or creosote-soaked wood. With a feed screw that is 50% larger* and a 10% faster pitch*, it's designed specifically for drilling deep holes in dense wood. The flutes are about two times wider* for maximum chip removal – even in the deepest holes. Only IRWIN offers the superior performance and added durability of WeldTec.

Use the chart below to determine which bit is best for the job at hand.

Bit Style	Size Range	Typical Trades	Application Benefits
 <p>Tri-Flute Bit</p>	7/16" to 1-1/2" diameter	Carpentry, Electrical, Plumbing	Fast, clean holes with reduced "break out" when through-hole drilling. Full-screw tip requires less effort.
 <p>Spade Bit</p>	1/4" to 1-1/2" diameter 4-3/4" to 16" lengths	Carpentry, Electrical, Plumbing	Fast, clean holes with reduced "break out" for through-hole drilling or countersinking.
 <p>Solid Center Auger Bit</p>	1/4" to 1-1/2" diameter 7-1/2" length	Carpentry, Electrical, Plumbing	Self-feeding tip pulls bit into the work for repetitive cutting of fast clean holes with a clean exit hole. Single-spur cutting edge scribes the circumference of the hole for a smoother finish.
 <p>Hollow Center Auger Bit</p>	3/8" to 2" diameter 7-1/2" to 29" lengths	Public Utilities, Electrical, Plumbing, Carpentry, Log Homes	Hollow center provides better chip removal for deeper holes in utility poles and logs.
 <p>Installer Bit</p>	1/4" to 3/4" diameter 12" to 30" lengths	Telecommunications, Cable/Internet, Security Systems	Wire hole near the end of the bit enables user to pull wire back through the hole after drilling.
 <p>Self-Feed Bit</p>	1" to 4-5/8" diameter	Plumbing, Electrical, General Contracting	Replaceable self-feeding tip pulls bit into the wood. Best for cutting larger holes with clean edges.
 <p>Forstner Bit</p>	1/4" to 2-1/8" diameter	Fine Woodworking, Cabinet Making	Precise cutting of smooth, flat-bottomed (blind) holes with clean, sharp edges.
 <p>Brad Point Bit</p>	1/8" to 1/2" diameter	Woodworking, Cabinet Making	Precise cutting of smooth through-holes with clean, sharp edges and reduced "break out."
 <p>Countersink Bit</p>	1/8" to 1/2" diameter	Woodworking, Cabinet Making	Perfect for variable-size countersink holes.
 <p>Plug Cutters</p>	1/8" to 1/2" diameter	Woodworking, Cabinet Making	Perfect for cutting dowels or plug holes.
 <p>Quick-Change Extensions</p>	1/4" available in 2", 6" and 12" length 3/8" available in 2", 5-1/2" and 12" length 7/16" available in 5-1/2", 12" and 18" length	Woodworking, Cabinet Making	Lock-n-Load® system for quick release and fast bit changes.

* vs. standard pole augers



SPEEDBOR® Max Speed Bits

The IRWIN® SPEEDBOR® Max Speed wood drilling bit is the FASTEST SPEEDBOR EVER™. The Speed Tip features a full screw-point that allows bit to self-feed, as well as three (3) cutting spurs for faster, cleaner holes, less breakout, and extended drilling life. The tapered tri-flute design allows for faster chip ejection and less binding. Its grooved hex shank prevents slipping and fits all standard 1/4" quick-change chucks, including impact drills.

SPEEDBOR MAX SPEED BIT FEATURES

1. Three cutting spurs for faster, cleaner holes, less breakout, and extended drilling life.
2. Full screw-point tip allows bit to self-feed for ease of drilling.
3. Tapered tri-flute design for faster chip ejection and less binding.
4. 1/4" quick-change shank reduces slipping in standard chucks and is compatible with all 1/4" quick-change chucks, including impact drills.*

*3/8" for 1-3/8" and 1-1/2" bits



3041004



THE FASTEST
SPEEDBOR EVER.

6-piece SPEEDBOR Max Speed Set



3041006

3-piece SPEEDBOR Max Speed Set



3041003

Quick-Change Extension



4935704

Diameter	Length	Shank Size	Item#	Bulk Item #
7/16"	6"	1/4" Quick-Change	3041015	3041015B
1/2"	6"	1/4" Quick-Change	3041001	3041001B
9/16"	6"	1/4" Quick-Change	3041014	3041014B
5/8"	6"	1/4" Quick-Change	3041002	3041002B
11/16"	6"	1/4" Quick-Change	3041016	3041016B
3/4"	6"	1/4" Quick-Change	3041004	3041004B
13/16"	6"	1/4" Quick-Change	3041017	3041017B
7/8"	6"	1/4" Quick-Change	3041005	3041005B
15/16"	6"	1/4" Quick-Change	3041018	3041018B
1"	6"	1/4" Quick-Change	3041007	3041007B
1-1/8"	6"	1/4" Quick-Change	3041019	3041019B
1-1/4"	6"	1/4" Quick-Change	3041009	3041009B
1-3/8"	6"	3/8" Quick-Change	3041020	3041020B
1-1/2"	6"	3/8" Quick-Change	3041021	3041021B

Sets

3-pc SPEEDBOR Max Speed Set (5/8", 3/4", 1")	3041003	—
6-pc SPEEDBOR Max Speed Set (1/2", 5/8", 3/4", 7/8", 1", 1-1/4")	3041006	—
10-pc SPEEDBOR Max Speed Set (7/16", 1/2", 9/16", 5/8", 3/4", 7/8", 1", 1-1/8", 1-1/4", 1-3/8")	1801022	—

Lock-n-Load® Quick-Change Extensions

1/4" Quick-Change Bit Holder 2-1/2" OAL / 5/8" OAW	4935703	—
1/4" Quick-Change Bit Holder 6" OAL / 5/8" OAW	4935704	—
1/4" Quick-Change Bit Holder 12" OAL / 5/8" OAW	4935705	—
3/8" Quick-Change Bit Holder 2-3/4" OAL / 7/8" OAW	4935651	—
3/8" Quick-Change Bit Holder 5-1/2" OAL / 7/8" OAW	4935652	—
3/8" Quick-Change Bit Holder 12" OAL / 7/8" OAW	4935653	—

SPEEDBOR® Spade Bits

SPEEDBOR SPADE BIT FEATURES

1. Patented Blue-Groove™ point and cutting edge for faster chip removal and overall drilling speed.
2. Double cutting spurs scribe the outside of the hole for reduced breakout and cleaner holes.
3. 40% thicker cutting edge and enlarged shank for increased strength and longer drilling life.*
4. 1/4" quick-change shank reduces slipping in standard chucks and is compatible with all 1/4" quick-change chucks, including impact drills.

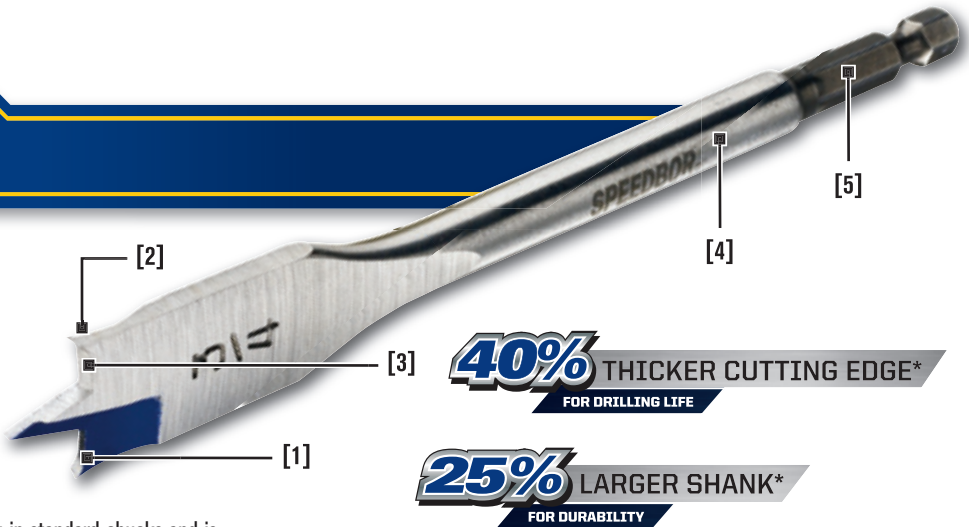

*versus previous IRWIN spade bits



87912

4-3/4" SPEEDBOR Short Length Spade Bits

- For drilling in tight spaces

Diameter	Length	Shank Size	Item #
1/2"	4"	1/4" Quick-Change	87908
5/8"	4"	1/4" Quick-Change	87910
3/4"	4"	1/4" Quick-Change	87912
7/8"	4"	1/4" Quick-Change	87914
1"	4"	1/4" Quick-Change	87916
1-1/4"	4"	1/4" Quick-Change	87920
1-1/2"	4"	1/4" Quick-Change	87924

WOOD DRILLING



88812

6" SPEEDBOR Standard Length Spade Bits

Diameter	Length	Shank Size	Item #	Bulk Item #
1/4"	6"	1/4" Quick-Change	88804	99904
5/16"	6"	1/4" Quick-Change	88805	99905
3/8"	6"	1/4" Quick-Change	88806	99906
7/16"	6"	1/4" Quick-Change	88807	99907
1/2"	6"	1/4" Quick-Change	88808	99908
9/16"	6"	1/4" Quick-Change	88809	99909
5/8"	6"	1/4" Quick-Change	88810	99910
11/16"	6"	1/4" Quick-Change	88811	99911
3/4"	6"	1/4" Quick-Change	88812	99912
13/16"	6"	1/4" Quick-Change	88813	99913
7/8"	6"	1/4" Quick-Change	88814	99914
15/16"	6"	1/4" Quick-Change	88815	99915
1"	6"	1/4" Quick-Change	88816	99916
1-1/8"	6"	1/4" Quick-Change	88818	99918
1-1/4"	6"	1/4" Quick-Change	88820	99920
1-3/8"	6"	1/4" Quick-Change	88822	99922
1-1/2"	6"	1/4" Quick-Change	88824	99924



88712

16" SPEEDBOR Extra-Long Spade Bits

- For extended reach
- Not for use with bit extensions or drill presses.

Diameter	Length	Shank Size	Item #	Bulk Item #
3/8"	16"	1/4" Hex	88706	99706
1/2"	16"	1/4" Hex	88708	99708
5/8"	16"	1/4" Hex	88710	—
3/4"	16"	1/4" Hex	88712	99712
7/8"	16"	1/4" Hex	88714	99714
1"	16"	1/4" Hex	88716	99716

SPEEDBOR Spade Bit Sets



88885



1764344

SPEEDBOR Spade Bit Pro Set



341008

- Sliding latch design provides added security.



4935704



88702

Standard Spurless Spade Bits



88012BULK

European Hinge Bits



IW14334

Description	Diameter	Item #
-------------	----------	--------

Short Length Spade Bit Sets

3-pc set	1/2", 3/4", 1"	87950 87954
6-pc Pro Set w/Extension	3/4", 7/8", 15/16", 1", 1-1/8" Short Length Bits; 6" OAL Quick-Change Extension	1768411

Standard Length Spade Bit Sets

3-pc Set	1/2", 3/4", 1"	88889
4-pc Set w/Extension	1/2", 3/4", 1", & 6" Quick-Change Extension	4935687
5-pc Set	3/8", 1/2", 5/8", 3/4", 1"	88885
6-pc Set	3/8", 1/2", 5/8", 3/4", 7/8", 1"	88886
6-pc Set w/Workshop Rack	3/8", 1/2", 5/8", 3/4", 7/8", 1" & Rack	88888
6-pc Set w/Extension	3/8", 1/2", 5/8", 3/4", 1" & 6" Quick-Change Extension	88898
8-pc Pro Set Case	3/8", 1/2", 5/8", 7/8", 1", 1-1/8", 1-1/2" & PRO Set Case	341008
13-pc Set	1/4", 5/16", 3/8", 7/16", 1/2", 9/16", 5/8", 11/16", 3/4", 13/16", 7/8", 15/16", 1"	88894
13-pc Set w/Workshop Rack	1/4", 5/16", 3/8", 7/16", 1/2", 9/16", 5/8", 11/16", 3/4", 13/16", 7/8", 15/16", 1"	88887
17-pc Set	1/4", 5/16", 3/8", 7/16", 1/2", 9/16", 5/8", 11/16", 3/4", 13/16", 7/8", 15/16", 1", 1-1/8", 1-1/4", 1-3/8", 1-1/2"	1792761

Standard Length Spade Bit Bulk Packs

4-pc Bulk Pack	5/8"	1764343
4-pc Bulk Pack	3/4"	1764344
4-pc Bulk Pack	1"	1764345

Lock-n-Load® Quick-Change Extensions

1/4" Quick-Change Bit Holder 2-1/2" OAL / 5/8" OAW	4935703
1/4" Quick-Change Bit Holder 6" OAL / 5/8" OAW	4935704
1/4" Quick-Change Bit Holder 12" OAL / 5/8" OAW	4935705

Manual Locking Hex Key Extensions

1/4" Hex Key Extension 6" OAL / 1-1/16" OAW	88702
1/4" Hex Key Extension 12" OAL / 1-1/16" OAW	88601

Hex Key Extensions compatible with:



Diameter	Length	Shank Size	Bulk Item #
3/8"	6"	1/4" Hex	88006BULK
1/2"	6"	1/4" Hex	88008BULK
5/8"	6"	1/4" Hex	88010BULK
3/4"	6"	1/4" Hex	88012BULK
7/8"	6"	1/4" Hex	88014BULK
1"	6"	1/4" Hex	88016BULK
1-1/8"	6"	1/4" Hex	88018BULK
1-1/4"	6"	1/4" Hex	88020BULK
1-1/2"	6"	1/4" Hex	88024BULK

Diameter	Length	Shank Size	Bulk Item #
26 mm	4"	1/4" Round	IW14334
35 mm	4"	1/4" Round	IW14335

IRWIN® Lock-n-Load® Quick-Change Extensions

QUICK-CHANGE BIT EXTENSION FEATURES

1. Lock-n-Load® system for quick release and fast bit changes.
2. Chrome-plated sleeve and body for improved durability and longer life.
3. Patented jaw design is compatible with 6-flatted shanks, ball detent (quick-change), and insert bits.
4. 1/4" range works with insert bits and is magnetic for additional holding power.



4935652

Lock-n-Load Compatibility

WOOD DRILLING

1/4"



- SPEEDBOR® Blue Groove (All Sizes)
- SPEEDBOR Max Speed (Sizes 7/16" to 1-1/4")
- Fastener Drive (All products)
- UNIBIT® (Sizes #1, #2, #10, #12)
- 1/4" Hole Saw Arbor (Sizes 9/16" to 1-3/16")
- Countersinks (Sizes #4 to #12)



3/8"



- SPEEDBOR Max Speed (Sizes 1-3/8", 1-1/4")
- UNIBIT (Sizes #3, #4, #11)
- 3/8" Hole Saw Arbor (Sizes 9/16" to 6" diameter saws)



7/16"

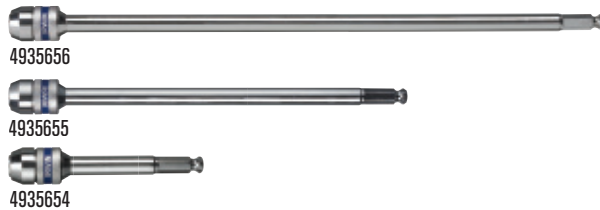

- 17" Ship Augers (Sizes 9/16" and larger)
- 7-1/2" Short Ship Augers (Sizes 1-1/8", 1-1/4")
- Self-Feed Bits (All sizes)
- UNIBIT (Sizes #5, #9, #13, #14, #20, #21)
- 1/2" Hole Saw Arbor (Sizes 1-1/4" - 6")



4935704

Description	Item #
1/4" Quick-Change Bit Holder 2-1/2" OAL / 5/8" OAW	4935703
1/4" Quick-Change Bit Holder 6" OAL / 5/8" OAW	4935704
1/4" Quick-Change Bit Holder 12" OAL / 5/8" OAW	4935705
3/8" Quick-Change Bit Holder 2-3/4" OAL / 7/8" OAW	4935651
3/8" Quick-Change Bit Holder 5-1/2" OAL / 7/8" OAW	4935652
3/8" Quick-Change Bit Holder 12" OAL / 7/8" OAW	4935653
7/16" Quick-Change Bit Holder 5-1/2" OAL / 1-1/16" OAW	4935654
7/16" Quick-Change Bit Holder 12" OAL / 1-1/16" OAW	4935655
7/16" Quick-Change Bit Holder 18" OAL / 1-1/16" OAW	4935656



88702

Manual Locking Hex Extensions

Description	Item #
1/4" Hex Key Extension 6" OAL / 1-1/16" OAW	88702
1/4" Hex Key Extension 12" OAL / 1-1/16" OAW	88601
7/16" Hex Key Extension 6" OAL / 1-1/16" OAW	3046001
7/16" Hex Key Extension 12" OAL / 1-1/16" OAW	3046002
7/16" Hex Key Extension 18" OAL / 1-1/16" OAW	3046003

Hex Key Extensions
Compatible With:



Ship Auger Bits with WeldTec™

The IRWIN® with WeldTec™ ship auger is made stronger and lasts longer than any ship auger in the world. It features a welded cutting edge that easily cuts through tough materials like nail-embedded wood. It has twice the nail cutting life of standard ship augers. With an aggressive screw-pitch for faster drilling, this bit is fully-forged for maximum durability, and wide flutes provide maximum chip removal with less binding.



WeldTec SHIP AUGER BIT FEATURES

1. Patent-pending welded cutting edge for extreme life in tough materials, including nail-embedded wood.
2. Aggressive screw-pitch for faster drilling.
3. Wide flutes for maximum chip removal with less binding.
4. Fully-forged bit for maximum durability.**

3043011

2X NAIL CUTTING LIFE*

* Compared to standard IRWIN ship augers
** Fully forged on bits 3/4" diameter and larger



WOOD DRILLING

7.5" Ship Auger Bits with WeldTec™



1779343

Diameter	Twist Length	Overall Length	Item #	Bulk Item #
3/8"	5"	7-1/2"	1779135	—
7/16"	5"	7-1/2"	1779136	—
1/2"	5"	7-1/2"	1779137	—
9/16"	5"	7-1/2"	1779138	—
5/8"	5"	7-1/2"	1779139	—
11/16"	5"	7-1/2"	1779140	—
3/4"	5"	7-1/2"	1779341	—
13/16"	5"	7-1/2"	1779342	—
7/8"	5"	7-1/2"	1779343	—
15/16"	5"	7-1/2"	1779344	—
1"	5"	7-1/2"	1779345	—
1-1/16"	5"	7-1/2"	1779346	—
1-1/8"	5"	7-1/2"	1779347	—
1-1/4"	5"	7-1/2"	1779348	—
1-3/8"	5"	7-1/2"	1779349	—
1-1/2"	5"	7-1/2"	1779350	—

17" Ship Auger Bits with WeldTec™



3043011

Diameter	Twist Length	Overall Length	Item #	Bulk Item #
3/8"	12"	17"	3043004	3043004B
7/16"	12"	17"	4935570	4935571
1/2"	12"	17"	3043005	3043005B
9/16"	12"	17"	3043006	3043006B
5/8"	12"	17"	3043007	3043007B
11/16"	12"	17"	3043008	3043008B
3/4"	12"	17"	3043009	3043009B
13/16"	12"	17"	3043010	3043010B
7/8"	12"	17"	3043011	3043011B
15/16"	12"	17"	3043012	3043012B
1"	12"	17"	3043013	3043013B
1-1/16"	12"	17"	4935572	4935573
1-1/8"	12"	17"	3043014	3043014B
1-1/4"	12"	17"	3043015	3043015B
1-3/8"	12"	17"	4935574	4935575
1-1/2"	12"	17"	3043016	3043016B
1-5/8"	12"	17"	—	1773957
1-3/4"	12"	17"	—	1773958
2"	12"	17"	—	1773959

Pole Auger Bits with WeldTec™

POLE AUGER BIT

FEATURES

1. Welded high speed steel cutting edge is sharper and larger so it cuts faster and lasts longer in dense, treated, or creosote-soaked wood.*
2. Feed screw is 50% larger and has a 10% faster pitch and is designed specifically for drilling deep holes in dense wood.*
3. Flutes are nearly two times wider for maximum chip removal in deep holes.*
4. Clean cutting spur is located opposite the cutting edge. It scribes the hole before cutting for cleaner, faster drilling and more efficient transfer of chips to the flute, enhancing overall drilling speed.
5. Available in both 7/16" and 5/8" impact rated shank sizes.

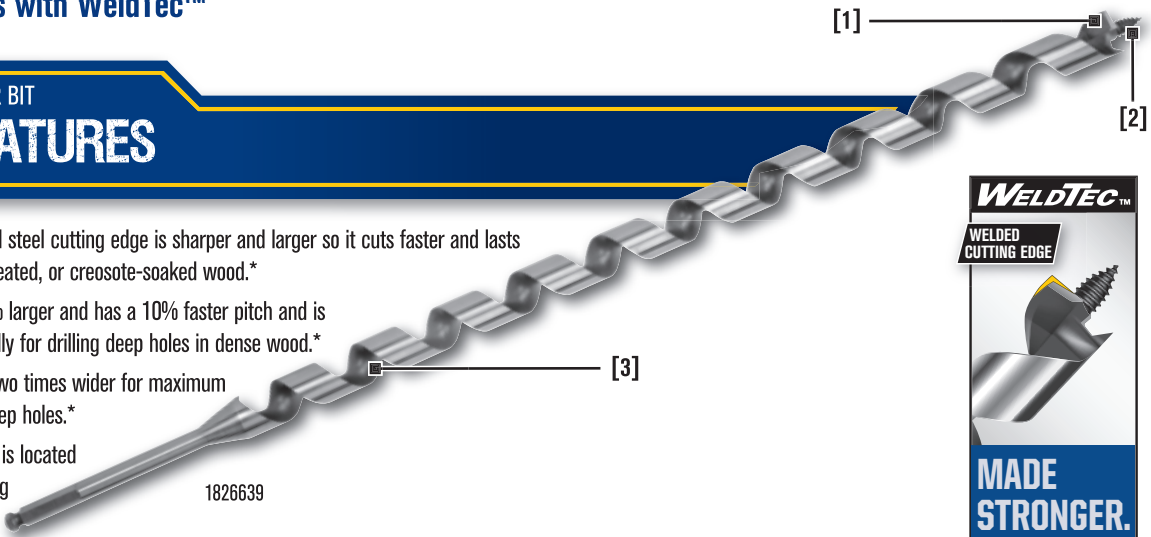

* vs. standard pole augers.

18" Pole Auger Bits with WeldTec™



1826635

Diameter	Shank Size	Twist Length	Overall Length	Item #
11/16"	5/8"	15"	18"	1826304
11/16"	7/16"	15"	18"	1826632
13/16"	5/8"	15"	18"	1826305
13/16"	7/16"	15"	18"	1826633
15/16"	5/8"	15"	18"	1826626
15/16"	7/16"	15"	18"	1826634
1-1/16"	5/8"	15"	18"	1826627
1-1/16"	7/16"	15"	18"	1826635

24" Pole Auger Bits with WeldTec™



1826639

Diameter	Shank Size	Twist Length	Overall Length	Item #
11/16"	5/8"	21"	24"	1826628
11/16"	7/16"	21"	24"	1826636
13/16"	5/8"	21"	24"	1826629
13/16"	7/16"	21"	24"	1826637
15/16"	5/8"	21"	24"	1826630
15/16"	7/16"	21"	24"	1826638
1-1/16"	5/8"	21"	24"	1826631
1-1/16"	7/16"	21"	24"	1826639

29" Pole Auger Bits with WeldTec™



1826649

Diameter	Shank Size	Twist Length	Overall Length	Item #
1/2"	7/16"	24"	29"	1826640
9/16"	7/16"	24"	29"	1826641
5/8"	7/16"	24"	29"	1826642
11/16"	7/16"	24"	29"	1826643
3/4"	7/16"	24"	29"	1826644
13/16"	7/16"	24"	29"	1826645
7/8"	7/16"	24"	29"	1826646
15/16"	7/16"	24"	29"	1826647
1"	7/16"	24"	29"	1826648
1-1/16"	7/16"	24"	29"	1826649

WOOD DRILLING



46616



Pole Auger Bits - Hand Brace / Adapter Shank

- Extra-long twist is ideal for drilling large poles, construction timbers, and for other timber applications.
- Cutting spur scribes the outside of the hole during drilling for a smooth, clean hole.
- Taper square shank can be removed for use in an electric drill or hand brace.
- Bit can be resharpened.
- Medium-fast screw point is ideal for general wood drilling applications.

Diameter	Shank Type	Twist Length	Overall Length	Bulk Item #
3/8"	Taper Square	12"	18"	46606
7/16"	Taper Square	12"	18"	46607
1/2"	Taper Square	12"	18"	46608
9/16"	Taper Square	12"	18"	46609
5/8"	Taper Square	12"	18"	46610
11/16"	Adapter Shank	12"	18"	46611
3/4"	Adapter Shank	12"	18"	46612
13/16"	Adapter Shank	12"	18"	46613ZR
7/8"	Adapter Shank	12"	18"	46614
15/16"	Adapter Shank	12"	18"	46615
1"	Adapter Shank	12"	18"	46616

Adapter Shank Fits both hand braces and power drills.



Taper square shank fits hand braces.



Cut off or square and use in both power drills and hand braces.



47915



Pole Auger Bits - Impact Shank

- Extra-long twist is ideal for drilling large poles, construction timbers, and for other timber applications.
- Cutting spur scribes the outside of the hole during drilling for a smooth, clean hole.
- Hex shank design for use in impact wrench drills.
- Bit can be resharpened.
- Medium-fast screw point is ideal for general wood drilling applications.

Diameter	Shank Size	Twist Length	Overall Length	Bulk Item #
9/16"	5/8"	15"	18"	48109
11/16"	5/8"	15"	18"	48111ZR
13/16"	5/8"	15"	18"	48113ZR
9/16"	7/16"	15"	18"	47909
11/16"	7/16"	15"	18"	47911
13/16"	7/16"	15"	18"	47913
15/16"	7/16"	15"	18"	47915
1-1/16"	7/16"	15"	18"	47917
1-1/16"	5/8"	21"	24"	48317
11/16"	5/8"	21"	24"	48311
13/16"	5/8"	21"	24"	48313
15/16"	5/8"	21"	24"	48315
11/16"	7/16"	21"	24"	48211
13/16"	7/16"	21"	24"	48213ZR
15/16"	7/16"	21"	24"	48215

Wood Drilling

Pole Auger Bits



47016



Pole Auger Bits – Hex Shank

- Extra-long twist is ideal for drilling in large poles, construction timbers, and for multiple timber applications.
- All bits feature 7/16" adaptable hex shank. Simply remove it to use round shank.
- Bit can be resharpened.
- Medium-fast screw point is ideal for general wood drilling applications.
- Cutting spur scribes the outside of the hole during drilling for a smooth, clean hole.

Diameter	Shank Size	Twist Length	Overall Length	Bulk Item #
9/16"	7/16"	12"	17"	46809
5/8"	7/16"	12"	17"	46810
11/16"	7/16"	12"	17"	46811
3/4"	7/16"	12"	17"	46812
13/16"	5/8"	12"	17"	46813
1-1/16"	7/16"	12"	18"	46617
9/16"	7/16"	12"	23"	46909
5/8"	7/16"	18"	23"	46910
11/16"	7/16"	18"	23"	46911
3/4"	7/16"	18"	23"	46912
13/16"	7/16"	18"	23"	46913ZR
7/8"	7/16"	18"	23"	46914ZR
15/16"	7/16"	18"	23"	46915ZR
11/16"	7/16"	18"	24"	46711
13/16"	7/16"	18"	24"	46713ZR
1"	7/16"	18"	24"	46716
9/16"	7/16"	24"	29"	47009
5/8"	7/16"	24"	29"	47010
11/16"	7/16"	24"	29"	47011
3/4"	5/8"	24"	29"	47012
13/16"	7/16"	24"	29"	47013
7/8"	7/16"	24"	29"	47014
15/16"	7/16"	24"	29"	47015
1"	7/16"	24"	29"	47016
1-1/16"	7/16"	24"	29"	47017

WOOD DRILLING



48715



Ship Auger Bits – Impact Shank

- Hex shank design for use in impact drills.
- Bit can be resharpened.
- Medium-fast screw point is ideal for general wood drilling applications.

Diameter	Shank Size	Twist Length	Overall Length	Bulk Item #
1/2"	7/16"	9"	12"	48508
9/16"	7/16"	9"	12"	48509
11/16"	7/16"	9"	12"	48511
13/16"	7/16"	9"	12"	48513
9/16"	7/16"	15"	18"	48709
11/16"	7/16"	15"	18"	48711
13/16"	7/16"	15"	18"	48713
15/16"	7/16"	15"	18"	48715
1-1/16"	7/16"	15"	18"	48717



49916



Solid Center Auger with Cutting Spur – I-100 Series

- Single cutting spur scribes the outside of the hole for faster drilling, cleaner holes, and a smoother finish.
- Solid-center design increases durability and provides rigidity for smooth, straight drilling.
- Coarse screw-point for fast drilling in soft and hard woods.
- Full-length heat-treating strengthens the twist, guarding against bending in tough applications, and improves overall bit durability and drilling life.

Diameter	Shank Size	Twist Length	Overall Length	Item #
1/4"	3/16"	4-1/2"	7-1/2"	49904
5/16"	7/32"	4-1/2"	7-1/2"	49905
3/8"	5/16"	4-1/2"	7-1/2"	49906
7/16"	5/16"	4-1/2"	7-1/2"	49907
1/2"	5/16"	4-1/2"	7-1/2"	49908
9/16"	5/16"	4-1/2"	7-1/2"	49909
5/8"	5/16"	4-1/2"	7-1/2"	49910
11/16"	5/16"	4-1/2"	7-1/2"	49911
3/4"	5/16"	4-1/2"	7-1/2"	49912
13/16"	5/16"	4-1/2"	7-1/2"	49913
7/8"	5/16"	4-1/2"	7-1/2"	49914
15/16"	5/16"	4-1/2"	7-1/2"	49915
1"	5/16"	4-1/2"	7-1/2"	49916
1-1/8"	7/16"	4-1/2"	7-1/2"	49918
1-1/4"	7/16"	4-1/2"	7-1/2"	49920
1-3/8"	7/16"	4-1/2"	7-1/2"	49922
1-1/2"	7/16"	4-1/2"	7-1/2"	49924
Solid Center Auger Bit Sets				
6-pc pouched contains 1/4", 3/8", 1/2", 5/8", 3/4" & 1"				49998
3-pc pouched contains 1/4", 3/8", & 1/2"				49999
Hex Key Extensions				
5/16" Hex Key Extension			18"	43805
7/16" Hex Key Extension			18"	3046003



43616

Hand Brace Solid Center Auger Bits – 62T Series

- Medium-fast screw point is ideal for general wood drilling applications.
- Full-length, heat-treated bit guards against bending in heavy-duty applications, and strengthens the twist where the greatest strain occurs.
- Double spur, double cutter design leaves an extremely clean hole finish.

Diameter	Shank Type	Twist Length	Overall Length	Item #	Bulk Item #
1/4"	Taper square	3-1/2"	7-1/2"	43604	—
5/16"	Taper square	3-5/8"	7-5/8"	43605	—
3/8"	Taper square	3-3/4"	7-3/4"	43606	—
7/16"	Taper square	3-7/8"	7-7/8"	43607	—
1/2"	Taper square	4"	8"	43608	—
9/16"	Taper square	4-1/8"	8-1/8"	43609	—
5/8"	Taper square	4-1/4"	8-1/4"	43610ZR	—
11/16"	Taper square	4-3/8"	8-3/8"	43611	—
3/4"	Taper square	4-1/2"	8-1/2"	43612	—
13/16"	Taper square	4-5/8"	8-5/8"	43613ZR	—
7/8"	Taper square	4-9/16"	8-3/4"	43614	—
15/16"	Taper square	4-11/16"	8-7/8"	43615	—
1"	Taper square	4-13/16"	9"	43616	—
1-1/2"	Taper square	4-7/8"	9-1/2"	—	43624
13-pc Pouch Set Contains 1/4" - 1"					43697



45516



Drilling Machine Auger Bits – 62R Series, 1/2" Round Shank

- Round shank is designed for use in power drills, drill presses, and drilling machines with 1/2" or larger chuck.
- Heavy stem increases strength and rigidity while reducing vibration. Shank length is 2".
- Medium-fast screw point is ideal for general wood drilling applications.

Diameter	Shank Size	Twist Length	Overall Length	Bulk Item #
7/16"	1/2" Round	6"	8"	45307
1/2"	1/2" Round	6"	8"	45308
9/16"	1/2" Round	6"	8"	45309
11/16"	1/2" Round	6"	8"	45311
13/16"	1/2" Round	6"	8"	45313
7/8"	1/2" Round	6"	8"	45314
1"	1/2" Round	6"	8"	45316
3/8"	1/2" Round	8"	10"	45406
7/16"	1/2" Round	8"	10"	45407
9/16"	1/2" Round	8"	10"	45409
3/4"	1/2" Round	8"	10"	45412
13/16"	1/2" Round	10"	12"	45513
1"	1/2" Round	10"	12"	45516
3/8"	1/2" Round	12"	14"	45606
1/2"	1/2" Round	12"	14"	45608
11/16"	1/2" Round	12"	14"	45611
3/4"	1/2" Round	12"	14"	45612
13/16"	1/2" Round	12"	14"	45613
7/8"	1/2" Round	12"	14"	45614
1"	1/2" Round	12"	14"	45616



38912

Wood Installer Bits

- Hole in flute for easy wire pulling through walls, ceilings, and floors.
- Premium alloy steel construction for extended drilling life.
- Special 82° point for fast drilling and easy starts.

Diameter	Shank Size	Overall Length	Item #	Bulk Item #
1/4"	.230"	12"	—	38904
5/16"	.285"	12"	—	38905
3/8"	.370"	12"	—	38906
1/2"	.370"	12"	—	38908
9/16"	.370"	12"	—	38909
5/8"	.370"	12"	—	38910
3/4"	.370"	12"	—	38912
1/4"	.230"	18"	39104	39004
5/16"	.285"	18"	39105	39005
3/8"	.370"	18"	39106	39006
7/16"	.370"	18"	39107ZR	39007
1/2"	.370"	18"	39108ZR	39008
9/16"	.370"	18"	39109ZR	—
5/8"	.370"	18"	39110	39010
11/16"	.370"	18"	39111	—
3/4"	.370"	18"	39112	—
1/4"	.230"	24"	—	39404
5/16"	.285"	24"	—	39405
3/8"	.370"	24"	—	39406
1/2"	.370"	24"	—	39408
1/4"	.230"	30"	—	39604
3/8"	.370"	30"	—	39606
1/2"	.370"	30"	—	39608
Installer Bit Sets				
3-pc Set 1/4", 3/8", 1/2"	—	—	—	3044001LW



40012

Carbide Tip Installer Bits

- Hole in flute makes it easy to pull wire through walls, ceilings, and floors.
- Specially designed flute quickly clears masonry dust.
- Heavy duty 118° point enters material quickly.
- Carbide tip and cutting edge is ideal for use where masonry construction is encountered, including brick, mortar joints, and cinder blocks.

Diameter	Shank Size	Overall Length	Bulk Item #
1/4"	.245"	18"	40004ZR
5/16"	.250"	18"	40005
3/8"	.370"	18"	40006
1/2"	.370"	18"	40008
5/8"	.370"	18"	40010
3/4"	.370"	18"	40012



45002

Adjustable Wood Bits

- Adjustable cutting blade bores a variety of hole sizes (Cuts 19 hole sizes in increments of 1/8").
- Lockhead screw securely holds blade at desired drilling diameter.

Diameter	Shank Size	Usage	Overall Length	Item #
5/8" - 1-3/4"	9/32"	Drill Press / Hand Brace	5-1/2"	44801
7/8" - 3"	11/32"	Drill Press / Hand Brace	6-1/2"	45002
7/8" - 3"	—	Hand Brace	6-1/2"	44202

WOOD DRILLING

SPEEDBOR MAX SELF-FEED BIT FEATURES

1. Three re-sharpenable cutting edges are hardened for extreme durability and long life in tough materials.*
2. Replaceable screw-point tip pulls bit fast for clean, true holes.
3. 7/16" hex quick-change shank reduces slipping in standard chucks and is compatible with all 7/16" impact drills.

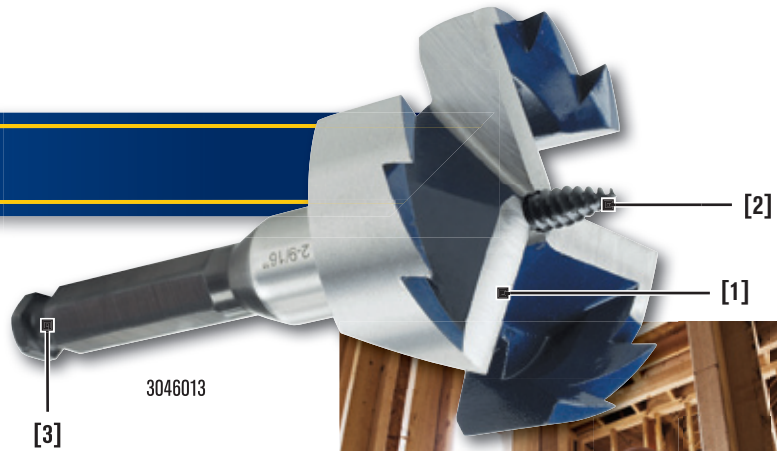

* 2 cutting edges on sizes 3" and larger

SPEEDBOR Max Self-Feed Wood Bits



3046010



4935655



3046002

Diameter	Shank Size	Overall Length	Item #
1"	7/16"	5"	3046004
1-1/8"	7/16"	5"	3046005
1-1/4"	7/16"	5"	3046006
1-3/8"	7/16"	5"	3046007
1-1/2"	7/16"	5"	3046008
1-3/4"	7/16"	5"	3046009
2"	7/16"	5"	3046010
2-1/8"	7/16"	5"	3046011
2-1/4"	7/16"	5"	3046012
2-9/16"	7/16"	5"	3046013
3"	7/16"	5"	3046014
3-5/8"	7/16"	5"	3046015
4-5/8"	7/16"	5"	3046016

Replacement Tips - Includes (5) Screw Tips, (5) Set Screws, and (1) Hex Key

Self-feed tips 1" - 1-3/8" bits	1792762
Self-feed tips 1-1/2" - 2-9/16" bits	1792763
Self-feed tips 3" - 4-5/8" bits	1792764

Lock-n-Load® Quick-Change Extensions

7/16" Quick-Change Bit Holder 5-1/2" OAL / 1-1/16" OAW	4935654
7/16" Quick-Change Bit Holder 12" OAL / 1-1/16" OAW	4935655
7/16" Quick-Change Bit Holder 18" OAL / 1-1/16" OAW	4935656

Manual Locking Hex Key Extensions

7/16" Manual Locking Hex Extensions 5-1/2" OAL / 1-1/16" OAW	3046001
7/16" Manual Locking Hex Extensions 12" OAL / 1-1/16" OAW	3046002
7/16" Manual Locking Hex Extensions 18" OAL / 1-1/16" OAW	3046003

Brad Point Bits



49618

- Brad point tip provides accurate positioning for starting the hole.
- Bit is precision-ground for use in furniture making, doweling, cabinetry, and other woodworking applications where an exact hole size is required.
- Spurs reduce splintering and ensure a smooth, clean hole.
- Wide flutes provide a fast, continuous flow of chip ejection.

Forstner Bits



42916

- Reduced shank fits 3/8" portable drills and drill presses.
- Brad point tip starts cleanly on uneven surfaces.

Forstner Bit Set



42940

Plug Cutters



43910

- Recommended for covering fastener holes in furniture, cabinetry, floors, decks, and other woodworking projects.
- Constructed of hardened, high-carbon steel for added strength and durability.
- Ideal for making dowels.

Adjustable Countersinks



90583

Diameter	Shank Size	Twist Length	Overall Length	Item #
1/8"	1/8"	1-7/16"	2-9/16"	49612
3/16"	3/16"	2-1/16"	3-3/8"	49613
1/4"	1/4"	2-1/2"	3-31/32"	49614
5/16"	5/16"	2-15/16"	4-19/32"	49615
3/8"	3/8"	3-7/16"	5-1/4"	49616
7/16"	3/8"	3-11/16"	5-19/32"	49617
1/2"	3/8"	3-31/32"	5-15/16"	49618
Brad Point Drill Bit Set				
5-pc pouched set contains 3/16", 1/4", 5/16", 3/8" & 1/2"				49600

Diameter	Shank Size	Item #
1/4"	3/8"	42904
3/8"	3/8"	42906
1/2"	3/8"	42908
5/8"	3/8"	42910
3/4"	3/8"	42912
7/8"	3/8"	42914
1"	3/8"	42916
1-1/8"	3/8"	42918
1-1/4"	3/8"	42920
1-3/8"	3/8"	42922
1-1/2"	3/8"	42924
1-5/8"	3/8"	42926
1-3/4"	3/8"	42928
1-7/8"	3/8"	42930
2"	3/8"	42932
2-1/8"	3/8"	42934
4" Extension	3/8"	42936
European Hinge Forstner Bit		
35mm	3/8"	4935685
Forstner Bit Set		
4-pc Set contains 5/8", 3/4", 7/8", 1"		
4-pc Set contains 5/8", 3/4", 7/8", 1"		

Diameter	Shank Size	Item #
1/4"	1/4"	43904
3/8"	1/4"	43906
1/2"	1/4"	43908
5/8"	1/4"	43910

Description	Counterbore Diameter	Drill Bit Size	Item #
#4 - 5 Countersink	3/8"	5/64"	90581
#6 - 7 Countersink	3/8"	3/32"	90582
#8 - 9 Countersink	3/8"	7/64"	90583
#10 Countersink	3/8"	1/8"	90584
#12 Countersink	1/2"	9/64"	90585

IRWIN[®]
TOOLS

WISE-GRIP ***MARATHON*** **QUICK-GRIP** ***SPEEDBOR*** **STRAIT-LINE** *Marples* ***Unibit*** **HANSON**.