

SECTION B - SPECIALTIES & REPAIR

Toilet Repairs 31-43

Kitchen & Bath 44-72

Plumbing Connectors/Supply Stops 73-76

Drinking Fountain Bubbler/Sink Faucets & Accessories 77-78

Gas Connectors 79-88

B

TANK LEVER TO TANK REFERENCE CHART

MFR.	PART NO.	FINISH	SECTION PAGE NO.	TANK STYLE
American Standard*	T01030	CP ABS	B2	Glenwall with vent #4049.177 Compack with vent #4052.346 Norwall with vent #4041.091
	T01031	PB ABS	DECORATIVE (SECT. A)	
	T01032 T01033	White ABS Bone ABS		
	T01042	CPS ABS	B2	Cadet II #4072 Cadet #4029 Cadet II #4014 Ellisse #4075 High Hamilton - 1 pc. #2096 Hamilton - 1 pc. #2092
	T01043	PB ABS	DECORATIVE (SECT. A)	Carlyle #2010.031 New Cadet line
	T01044	White ABS		
	T01045	Bone ABS		
	T01048	CPS ABS	B2	Glenwall #2093 Cadet #2108 Cadet #2109 Cadet #2120 Cadet #2124 Plebe #2131 Plebe #2138 Plebe #2139 Plebe Aquameter
	T01049	PB ABS	DECORATIVE (SECT. A)	
	T01050	CPS ABS	B2	
	T01051	PB ABS	DECORATIVE (SECT. A)	Old style, thick walled
	T01052	White ABS		
T01053	Bone ABS			
	T01064	CP Metal	B2	
	T01065	PB Metal	DECORATIVE (SECT. A)	
Crane*	T01034	CPS ABS	B2	Galaxy New Galaxy Sante Fe Avon Antigua
Eljer*	T01020	CP Metal	B3	New Emblem
	T01021	PB Metal	DECORATIVE (SECT. A)	
Kohler*	T01010	CP Metal	B3	Wellworth*/Barrington* - Old Style
	T01012	CP Metal	B3	
	T01015	PB Metal	DECORATIVE (SECT. A)	Kohler 9400
	T01016	CP Metal	B3	Wellworth*/Barrington Lite* - Old Style
	T01017	PB Metal	DECORATIVE (SECT. A)	
Mansfield*	T01040	CPS ABS	B3	Mansfield #35 Mansfield #51 Mansfield #8 Mansfield #16 Mansfield #35LT
	T01073	PB ABS	DECORATIVE (SECT. A)	
	T01072	CP Metal	B3	Mansfield old style #42
	T01041	PB Metal	DECORATIVE (SECT. A)	
Universal Rundle*/Sears*	T01066	CP Metal	B3	Saturn 4012 Low Boy 4445
	T01067	PB Metal	DECORATIVE (SECT. A)	

*The manufacturers' names are used only to describe whose products the tank levers will fit. The tank levers are not manufactured by those companies.

Fit-All Tank Trip Lever



B

PART NO.	FINISH	DESCRIPTION	CTN/MSTR
T01001	CP Metal	Brass arm with Metal spud and nut	25/200
T01002	CP Metal	Brass plated arm with Metal spud and nut	25/200
T01200	CP Metal	Aluminum arm with Zinc spud and nut	25/200
T01201	CP Metal	Aluminum arm with Plastic spud and nut	25/200
T01099	Brass	Replacement spud nut	1/25

Fit-All Economy Tank Trip Lever

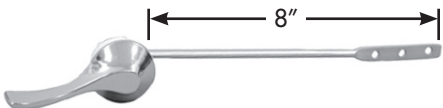

PART NO.	FINISH	DESCRIPTION	CTN/MSTR
T01060	CP Metal	Brass plated arm with Plastic spud & nut/ Universal fit	25/200

Fit-All Tank Trip Lever

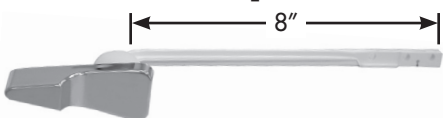

PART NO.	FINISH	DESCRIPTION	CTN/MSTR
T01062	CP ABS	Plastic arm, spud & nut Universal fit	25/125

Fit-All Heavy Duty Tank Trip Lever



PART NO.	FINISH	DESCRIPTION	CTN/MSTR
T01005	CP Metal	Brass arm with Metal spud and nut/ Universal fit	25/150

Fit-All Premium Tank Trip Lever

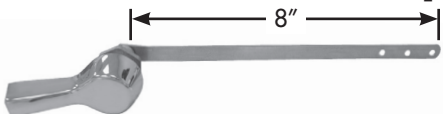

PART NO.	FINISH	DESCRIPTION	CTN/MSTR
T01068	CP Metal	Flat brass arm with Metal spud and nut	25/200

Fit-All Side Mount Tank Trip Lever

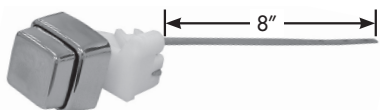

PART NO.	FINISH	DESCRIPTION	CTN/MSTR
T01070	CP ABS	Side Mount push button Brass arm with Plastic spud and nut	1/50

Fit-All Front Mount Tank Trip Lever

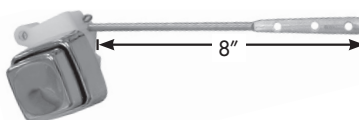

PART NO.	FINISH	DESCRIPTION	CTN/MSTR
T01074	CP ABS	Front Mount push button Brass arm with Plastic spud and nut	1/50

American Standard* Tank Trip Lever

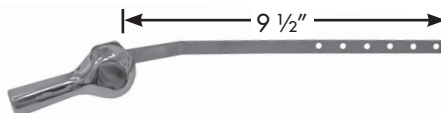

PART NO.	FINISH	DESCRIPTION	CTN/MSTR
T01064	CP Metal	Brass arm with Metal spud and nut Offset for thick tank walls	25/150

* The manufacturers' names are used only to describe whose products the tank levers will fit. The tank levers are not manufactured by those companies.

American Standard* Tank Trip Lever

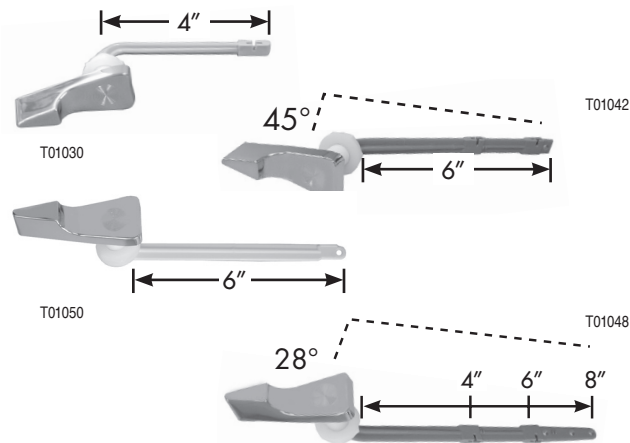

PART NO.	FINISH	DESCRIPTION	CTN/MSTR
T01030	CP ABS	Plastic arm, spud and nut for beaded chain	25/250
T01042	CP ABS	45° arm for Cadet 2* Plastic arm, spud and nut	1/25
T01050	CP ABS	Plastic arm, spud and nut for Plebe* and Cadet*	1/25
T01048	CP ABS	Neo 28° combo with Plastic arm, spud and nut	1/25

* The manufacturers' names are used only to describe whose products the tank levers will fit. The tank levers are not manufactured by those companies.

Crane* Tank Trip Lever

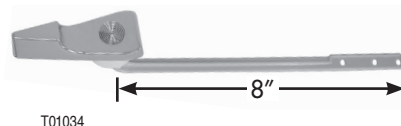

PART NO.	FINISH	DESCRIPTION	CTN/QTY
T01034	CP ABS	Plastic arm with Plastic spud and nut	25/250

* The manufacturers' names are used only to describe whose products the tank levers will fit. The tank levers are not manufactured by those companies.

Eljer* Tank Trip Lever

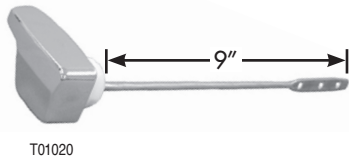

PART NO.	FINISH	DESCRIPTION	CTN/MSTR
T01020	CP Metal	Side Mount/Brass arm with Non-crack nylon spud and nut	25/200

* The manufacturers' names are used only to describe whose products the tank levers will fit. The tank levers are not manufactured by those companies.

Kohler* Tank Trip Lever

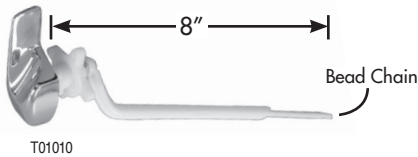

PART NO.	FINISH	DESCRIPTION	CTN/MSTR
T01010	CP Metal	Wellworth*/Barrington* Old style/Side mount Plastic arm (less bead hook), spud and nut	25/150
T01016	CP Metal	Wellworth*/Barrington Lite* New style/Side Mount 1.6 gal. unit replacement Plastic arm, spud and nut	25/125

* The manufacturers' names are used only to describe whose products the tank levers will fit. The tank levers are not manufactured by those companies.

Kohler* Tank Trip Lever

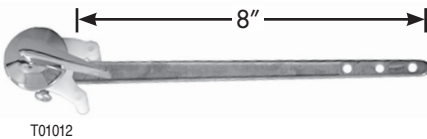

PART NO.	FINISH	DESCRIPTION	CTN/MSTR
T01012	CP Metal	Cast brass arm with Metal spud and nut	25/125

* The manufacturers' names are used only to describe whose products the tank levers will fit. The tank levers are not manufactured by those companies.

Mansfield* Tank Trip Lever

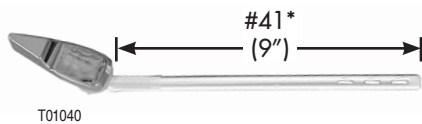

PART NO.	FINISH	DESCRIPTION	CTN/MSTR
T01040	CP ABS	#41* Plastic arm, spud and nut	1/25

* The manufacturers' names are used only to describe whose products the tank levers will fit. The tank levers are not manufactured by those companies.

Mansfield* Tank Trip Lever

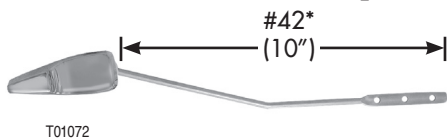

PART NO.	FINISH	DESCRIPTION	CTN/MSTR
T01072	CP Metal	#42* Brass arm with plastic spud and nut	25/100

* The manufacturers' names are used only to describe whose products the tank levers will fit. The tank levers are not manufactured by those companies.

Universal Rundle*/Sears* Tank Trip Lever

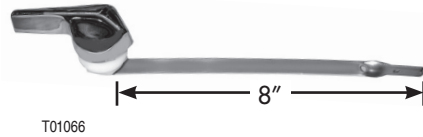

PART NO.	FINISH	DESCRIPTION	CTN/MSTR
T01066	CP Metal	Brass arm with Plastic spud and nut Fits Universal Rundle*/Sears*	25/100

* The manufacturers' names are used only to describe whose products the tank levers will fit. The tank levers are not manufactured by those companies.

Ultrafit Tank Lever

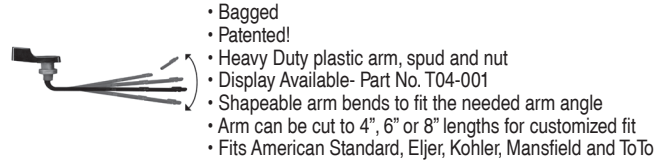

- Bagged
- Patented!
- Heavy Duty plastic arm, spud and nut
- Display Available- Part No. T04-001
- Shapeable arm bends to fit the needed arm angle
- Arm can be cut to 4", 6" or 8" lengths for customized fit
- Fits American Standard, Eljer, Kohler, Mansfield and ToTo

PART NO.	DESCRIPTION	CTN/MSTR
T01100	CP ABS Ultrafit tank lever	25/200

Western Pottery Tank Trip Lever



- Side Mount
- 10 inch brass arm
- Plastic spud and nut

PART NO.	DESCRIPTION	CTN/MSTR
T01080	Western Pottery tank trip lever	25/200

ToTo Chrome Plated Tank Lever



- Side Mount
- 10 inch brass arm
- Plastic spud and nut

PART NO.	DESCRIPTION	CTN/MSTR
T01081	ToTo chrome plated tank trip lever	25/200

Eljer* Touch Flush* Assembly



- CARTON QUANTITIES ONLY
- Complete with tank, lever, chain, ball and arm

PART NO.	DESCRIPTION	CTN/MSTR
C04019	Touch Flush assembly	1/5

* The manufacturers' names are used only to describe whose products the products will fit.

Tank Ball and Seat Discs



- CARTON QUANTITIES ONLY
- New boxing to protect shape of units

PART NO.	DESCRIPTION	CTN QTY
C04020	Eljer* tank ball for touch flush	1/10
C04021	Fit-All tank ball less guide	1/10
C04030	2 1/4" - 2 5/8" Tri-seal tank ball boxed	1/100
C04031	3" Tri-seal tank ball boxed	1/100

American Standard* Seat Disc Tank Ball

(for small tilt flush valves)

B



C04024



T02025

- CARTON QUANTITIES ONLY
- Units are in a plastic housing to protect the shape of the seats

PART NO.	DESCRIPTION	CTN/MSTR
C04024	Screw-on unit	1/25
C04025	Snap-on unit	1/25
T02025	Combo seat disc, snap-on and screw-on	1/25

* The manufacturers' names are used only to describe whose products the tank levers will fit. The tank levers are not manufactured by those companies.

Float Ball



- CARTON QUANTITIES ONLY ON THE C05041

PART NO.	DESCRIPTION	CTN/MSTR
C05040	Plastic 4" x 5"	1/24
C05041	Copper 4" x 5"	12/72

Flappers



C04005



C04006 comes with strap and chain



C04007 comes with strap and chain



C04008



C04010



C04011

- High grade vinyl construction
- CARTON QUANTITIES ONLY
- New boxing to protect shape of units

PART NO.	DESCRIPTION	CTN/MSTR
C04005	3 way with strap (fits plastic, brass and old Crane* 57 flush valves)	25/100
C04006	3 way with stainless chain (fits plastic, brass and old Crane* 57 flush valves)	25/100
C04007	Standard unit (9" chain)	1/10
C04008	Kohler* unit (8" chain)	50/200
C04010	Crane* unit (9" chain)	50/200
C04011	Eljer* original unit with rigid arms and foam cone with beaded chain	1/10

* The manufacturers' names are used only to describe whose products the products will fit.

Kohler Rialto™ Flapper



C04028



C04029

MADE IN THE USA



- 5 year warranty
- Blister carded for easy display
- Made from high grade chlorazone
- Resists chemicals and toilet tank cleaners

PART NO.	DESCRIPTION	FITS KOHLER MODELS	CTN/MSTR
C04028	Kohler Flapper 2010 BP	Rialto, San Raphael, Santa Martine and Rosario	12/72
C04029	Sharkfin Flapper 2012 BP	Rialto, San Raphael, Santa Rosa, Revival and Gabrielle	12/72

2 Way Flapper With Separate Trunion



- Siliconized chemical resistant material
- Stainless steel chain

PART NO.	DESCRIPTION	CTN/MSTR
C04002	2 way flapper	1/10

Carded Blue Vinyl Flapper



- Chemical resistant
- Individually carded
- Soft body replacement flapper
- 9" stainless steel chain and hook
- Five year warranty on flapper life

PART NO.	DESCRIPTION	CTN/MSTR
C04004	Carded blue fit-all vinyl flapper	25/100

Jumbo ToTo Style Flapper



PART NO.	DESCRIPTION	CTN/MSTR
C04000	Blue Flapper (Power Gravity)	1/10
C04001	Red Flapper (G-Max)	1/10

Blue Vinyl Flapper



- Chemical Resistant
- Five Year Warranty
- Fits most plastic flush valves

MADE IN THE USA



- CARTON QUANTITIES ONLY
- Easily installed- no collar to cut
- 9" stainless steel chain and hook

PART NO.	DESCRIPTION	CTN/MSTR
C04014	Blue vinyl flapper	1/80

Korky® Flappers

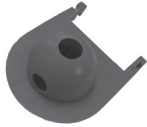

C04032

- C04032 Fits Kohler® Class Five™ Flapper
- Larger 3 1/4" replacement flapper
 - Replaces Kohler No. 1016546 & 1042313
 - Engineered materials resist chlorine

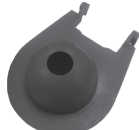

C04033

- C04033 Fits Eljer®Titan™ Flapper
- Replaces Eljer No. 495-6077-00
 - Engineered materials chlorine



C04034

- C04034 Fits American Standard® Cadet 3® Flapper
- Replaces American Stand No. 738920-0070P
 - Engineered materials resist chlorine

PART NO.	DESCRIPTION	CTN/MSTR
C04032	Fits Kohler® Class Five™ Flapper	1/5
C04033	Fits Eljer®Titan™ Flapper	1/5
C04034	Fits American Standard® Cadet 3® Flapper	1/5

Korky® Flappers

The Original Korky® Flapper



- No tank centering
- Assures a positive seal
- Easy fingertip operation
- Individually carded in cartons
- Eliminates lift wire misalignment
- Chemical resistant- Effective--/--/07 in areas with poor water quality



PART NO.	DESCRIPTION	CTN/MSTR
C04015	(54 BP)	12/72
C04017	Fits Kohler (58 BP)	10/100

Red Korky® Plus Flapper



- Guaranteed chemical resistant for 5 years
- Individually carded in cartons of 12



PART NO.	DESCRIPTION	CTN/MSTR
C04016	Red Korky® Plus (2001BP)	12/72

Korky® 1.6 Adjustable Flapper



- Chemical resistant
- Easy to install and adjust
- Individually carded in cartons of 12
- Flush volume changes with just a twist
- Can be used as a water saving device
- Adjustable sealing ball for precise water control
- Universal design fits most popular brands of 1.6 toilets



PART NO.	DESCRIPTION	CTN/MSTR
C04027	Korky® 1.6 adjustable flapper (16BP)	12/72

Korky® Plus Adjustable Flapper



- Adjust flush volume with movable float on chain
- Slide the float up for water savings or down for increased flush volume
- Premium red Chlorazone rubber resists chlorine



PART NO.	DESCRIPTION	CTN/MSTR
C04013	Korky® Plus adjustable flapper	1/12

Closest Spuds



- Cast brass
- Includes spud washer and metal friction ring

PART NO.	DESCRIPTION	CTN/MSTR
C27125	1 1/4"	25/100
C27150	1 1/2"	25/100
C27200	2"	25/75
C27201	2" x 1 1/4"	25/100
C27202	2" x 1 1/2"	25/75
C27127	1 1/2" x 1 1/4"	25/100
C27150A	1 1/2" (For American Standard)	25/100

Urinal Spuds



- Cast brass
- Includes spud washer and metal friction ring

PART NO.	DESCRIPTION	CTN/MSTR
C27134	1" x 3/4"	25/200
C27126	1 1/4" x 3/4"	25/125
C27310	1 1/2" x 3/4"	25/500

Closest Spud Washers



- CARTON QUANTITIES ONLY

PART NO.	DESCRIPTION	CTN/MSTR
C27301	1 1/4"	25/500
C27302	1 1/2"	25/500
C27303	2"	25/500
C27304	2" x 1 1/4"	25/500
C27305	2" x 1 1/2"	25/500
C27308	1" x 3/4"	25/500
C27309	1 1/4" x 3/4"	25/500

Closest Spud Friction Rings



- Zinc plated
- CARTON QUANTITIES ONLY

PART NO.	SIZE	CTN/MSTR
C27321	1 1/4"	25/1000
C27322	1 1/2"	25/1000
C27323	2"	25/1000
C27324	2" x 1 1/4"	25/1000
C27325	2" x 1 1/2"	25/1000
C27328	1" x 3/4"	25/1000

Flush Valve Shank Washer

• 3 1/16" OD x 2 1/4" ID



B

PART NO.	DESCRIPTION	CTN/MSTR
T02028	3/8" Height flush valve shank washer	1/100

Aqua Seal Washer



• Rubber
• American Standard Top Hat Washer

PART NO.	DESCRIPTION	CTN/MSTR
T85057	Aqua Seal Washer	1/100

Beveled Ballcock Shank Washer

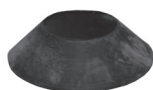

• Rubber
• 1 3/4" OD x 15/16" ID

PART NO.	DESCRIPTION	CTN/MSTR
T85056	1/2" Beveled Ballcock shank Washer	1/100

Flat Bibb Washer



• Priced per carton
• 100 pieces per carton

PART NO.	SIZE	TRADE SIZE	OD	CTN/MSTR
O25202	1/4"	00	1/2"	1
O25203	1/4"	0	17/32"	1
O25204	1/4"	1/4	9/16"	1
O25205	1/4"	1/4L	19/32"	1
O25206	3/8"	3/8	5/8"	1
O25207	3/8"	3/8M	21/32"	1
O25208	3/8"	3/8L	11/16"	1
O25209	1/2"	1/2	3/4"	1
O25210	1/2"	1/2L	25/32"	1

Beveled Bibb Washer



• Priced per carton
• 100 pieces per carton

PART NO.	SIZE	TRADE SIZE	OD	CTN/MSTR
O25302	1/4"	00	1/2"	1
O25303	1/4"	0	17/32"	1
O25304	1/4"	1/4	9/16"	1
O25305	1/4"	1/4L	19/32"	1
O25306	3/8"	3/8	5/8"	1
O25307	3/8"	3/8M	21/32"	1
O25308	3/8"	3/8L	11/16"	1
O25309	1/2"	1/2	3/4"	1
O25310	1/2"	1/2L	25/32"	1

Sponge Closet Gaskets



• All have 2 bolt holes

G13500

G13534

G13634

PART NO.	OD x ID x THICKNESS	CTN/MSTR
G13534	5 3/8" x 3 1/2" x 3/4"	10/200
G13516	5 3/8" x 3 1/2" x 9/16"	10/232
G13634	6 3/4" x 3 1/2" x 3/4" w/ 2 bolt holes	10/120
G13601	6 3/4" x 3 1/2" x 1" w/ 2 bolt holes	10/84
G13616	6 3/4" x 3 1/2" x 9/16" w/ 2 bolt holes	10/134
G13638	6 3/4" x 3 1/2" x 3/8" w/ 2 bolt holes	10/200
G13500	4 3/8" x 2 7/8" x 1/2" wall hung urinal	10/225

Brass Lift Wire Guide



• Fit-All
• CARTON QUANTITIES ONLY

C05056

C05057

PART NO.	DESCRIPTION	CTN/MSTR
C05056	Adjustable heavy pattern	25/500
C05057	Standard split ring	25/500

Brass Lift Wire



• CARTON QUANTITIES ONLY

PART NO.	DESCRIPTION	CTN/MSTR
C05045	4 1/2" lower	25/2000
C05046	5" lower	25/2000
C05047	5 1/2" lower	25/2000
C05048	8" upper	25/1000
C05049	9" upper	25/1000

Copper Refill Tube



• CARTON QUANTITIES ONLY

PART NO.	SIZE	CTN/MSTR
C05051	9"	25/1000

Brass Float Rod



• CARTON QUANTITIES ONLY

PART NO.	SIZE	CTN/MSTR
C05052	1/4" x 8"	25/1000
C05053	1/4" x 10"	25/1000
C05054	1/4" x 12"	25/1000

Brass Overflow Tube

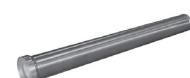

• 22 gauge

PART NO.	SIZE	CTN/MSTR
C05042	1" x 1 1/8" x 10"	1/200

Douglas Flush Valve



C05070



C05071

- Brass unit includes split guide
- Includes locknut, beveled washer
- Plastic unit includes flapper tank ball

PART NO.	DESCRIPTION	CTN/MSTR
C05070	Plastic with stainless steel chain	1/50
C05071	Brass	1/40

Mansfield* Style Ballcock



- All brass
- Compound lever

PART NO.	DESCRIPTION	CTN/MSTR
T02075	Brass Ballcock	1/50

* The manufacturer's name is used only to describe whose product the ballcock will fit. The part listed is not necessarily manufactured by that company.

Mansfield Style Ballcock With Float Rod



T03008

- Genuine Mansfield Ballcock

PART NO.	DESCRIPTION	CTN/MSTR
T03008	Ballcock with float rod #08	1/20

Mansfield Flush Valve #210



- Water saver
- 3.5 gal. toilets
- Instant shut-off
- Won't rust or corrode

PART NO.	DESCRIPTION	CTN/MSTR
T02066	Flush Valve	1/50

Korky® QuietFill Valve



- Resists chlorine
- 5 year guarantee



PART NO.	DESCRIPTION	CTN/MSTR
C05200	Korky® QuietFill Valve	1/24

American Standard* Toilet Repair Parts



T02020



T02021



T02022



T02023

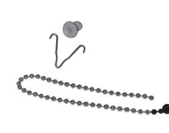

T02024



T02026

PART NO.	DESCRIPTION	CTN/MSTR
T02020	#5 (33642-07) old style low profile actuator unit, black, with disc, chain, clip and grommet	1/5
T02021	#6 (72880-07) old style high profile actuator unit, complete, black with disc, chain, clip and grommet	1/5
T02022	#4 (8162-07) old style high profile actuator unit with legs for one piece low boy* with brass flush valves, complete, black with disc, chain, clip, grommet and legs	1/5
T02023	#4 (70711-07) old style Cadet* water saver actuator unit, white with blue cap complete with disc, chain, clip and grommet	1/5
T02024	Chain kit complete for all actuator units (American Standard* 8321-07)	1/5
T02026	#4 (47107-07) new style complete flush valve unit, white, short actuator	1/5
T02027	#5 (47089-07) complete flush valve tall black for standard two-piece closets	1/5

Ballcock Repair Parts For American Standard*



T02035



T02036

PART NO.	DESCRIPTION	CTN/MSTR
T02035	7307 cap and plunger with seat, new style	1/10
T02036	N3010 ballcock plunger with thumb hole	1/10

Ballcock Repair Parts For Coast*



T02037



T02038



T02039

PART NO.	DESCRIPTION	CTN/MSTR
T02037	Coast 1B1*, 1B1P*, standard large head kit with 3 screws	1/10
T02038	Coast 1B1A*, smaller head kit with 3 screws	1/10
T02039	Coast 1B1X*, Kohler*, UR*, Eljer*, Briggs*, American Standard*, kits with 3 screws, high and low boy	1/10

Ballcock Repair Parts For Hoover* / Amerline*

B



PART NO.	DESCRIPTION	CTN/MSTR
T02050	Standard kit with 4 screws	1/25

Ballcock Repair Parts For Kohler*



PART NO.	DESCRIPTION	CTN/MSTR
T02051	Black plunger with cap and seal	1/10

Ballcock Repair Parts For Fluidmaster*



PART NO.	DESCRIPTION	CTN/MSTR
T02052	Diaphragm N/S heavy duty white for hard water and chloramines (Ref. 242F)	1/10
T02053	Standard black diaphragm (Ref. 242)	1/10

Mansfield Ballcock and Flush Valve Repair Parts

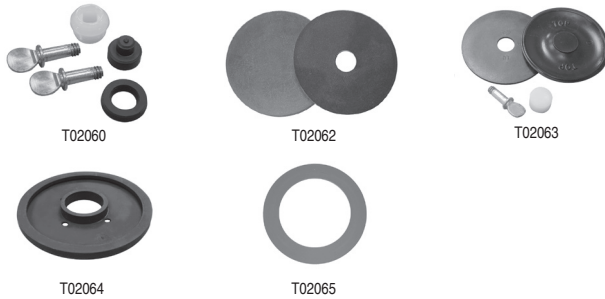

• Original Mansfield parts

PART NO.	DESCRIPTION	CTN/MSTR
T02060	03, 09, XQ-16 ballcock repair kit	1/10
T02062	08 ballcock repair kit	1/10
T02064	208/209 flush valve diaphragm	10/50
T02065	210/211 flush valve seal	10/700

Dual Flush Toilet Kit



- Simple to install
- Save water with every flush!
- Push one way to rinse liquid
- Push the other way to flush solids

PART NO.	DESCRIPTION	CTN/MSTR
T02067	Dual Flush Toilet Kit	1/40

Toilet Tank Cover



- Fit-All
- White plastic
- Fits most tanks with outside dimensions of 21 1/8" x 7 3/8" or less

PART NO.	DESCRIPTION	CTN/MSTR
T02005	White	1/1

Enduro Closet Bolts



- Never Rusts
- Space age composite
- Fits all closet flange styles
- CARTON QUANTITIES ONLY
- Withstands over 1,000 PSI

PART NO.	DESCRIPTION	CTN/MSTR
C02050	5/16" x 2 1/2" closet bolt	50 pairs/500 pairs

Enduro Closet Bolt Jar Display



- Never rusts
- Space age material
- Fits all closet flange styles

PART NO.	DESCRIPTION	CTN/MSTR
CJ1003	5/16" x 2 1/2" closet bolt (50 pairs per display)	1/1

Flexible and Rigid Super Shims

MADE IN THE USA

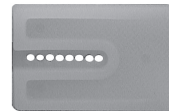

- Stackable
- Rigid, can be driven
- Flexible, can be trimmed
- Priced per bag
- 10 per bag

PART NO.	DESCRIPTION	CTN/MSTR
S55950	1-1/8" x 1-15/16" x 1/4" flexible	1 bag of 10/400
S55951	1-1/8" x 1-15/16" x 1/4" rigid	1 bag of 10/400

Closet Wedge Shims

MADE IN THE USA



- Stackable
- 3/8" width x 1-3/8" length x 5/16" height
- Easily trimmed to desired height
- Priced per bag or display

PART NO.	DESCRIPTION	CTN/MSTR
S55902	100 shims poly bagged	1/1
S55903	1000 shims counter display	1/1

Flexible Super Shims

MADE IN THE
USA



- 200 Flexible super shims packaged in a convenient refillable "candy bowl" counter display
- Priced per display

PART NO.	DESCRIPTION	CTN/MSTR
S55952	200 Flexible super shims	1/1

Rigid Super Shims

MADE IN THE
USA



- 200 Rigid super shims packaged in a convenient refillable "candy bowl" counter display
- Priced per display

PART NO.	DESCRIPTION	CTN/MSTR
S55953	200 Rigid super shims	1/1

"Bucket Of Bolts"



- Attractive counter/shelf display
- Closet bolts are custom packed (2 bolts, nuts, and washers per bag)

Brass Plated

PART NO.	SIZE	WASHER	CTN/MSTR
CB2001	1/4" x 2 1/4"	Oval	50 pairs/1
CB2011	1/4" x 2 1/4"	Round	50 pairs/1
CB2002	1/4" x 3 1/2"	Oval	50 pairs/1
CB2012	1/4" x 3 1/2"	Round	50 pairs/1
CB2003	5/16" x 1 3/4"	Oval	50 pairs/1
CB2013	5/16" x 1 3/4"	Round	50 pairs/1
CB2004	5/16" x 2 1/4"	Oval	50 pairs/1
CB2014	5/16" x 2 1/4"	Round	50 pairs/1
CB2005	5/16" x 3 1/2"	Oval	50 pairs/1
CB2015	5/16" x 3 1/2"	Round	50 pairs/1

Brass

PART NO.	SIZE	WASHER	CTN/MSTR
CB2021	1/4" x 2 1/4"	Oval	50 pairs/1
CB2030	1/4" x 2 1/4"	Round	50 pairs/1
CB2022	1/4" x 3 1/2"	Oval	50 pairs/1
CB2031	1/4" x 3 1/2"	Round	50 pairs/1
CB2023	5/16" x 1 3/4"	Oval	50 pairs/1
CB2032	5/16" x 1 3/4"	Round	50 pairs/1
CB2024	5/16" x 2 1/4"	Oval	50 pairs/1
CB2033	5/16" x 2 1/4"	Round	50 pairs/1
CB2025	5/16" x 3 1/2"	Oval	50 pairs/1
CB2034	5/16" x 3 1/2"	Round	50 pairs/1

Closet Bolts With Tinnerman Nuts



- CARTON QUANTITIES ONLY
- Two each bolts, nuts, round washers and tinnerman nuts per bag

Brass Plated

PART NO.	SIZE	CTN/MSTR
C02401	1/4" x 2 1/4"	50 pairs/400
C02402	1/4" x 3 1/2"	50 pairs/200
C02403	5/16" x 1 3/4"	50 pairs/200
C02404	5/16" x 2 1/4"	50 pairs/200
C02405	5/16" x 3 1/2"	50 pairs/200

Brass

PART NO.	SIZE	CTN/MSTR
C02421	1/4" x 2 1/4"	50 pairs/400
C02990	1/4" x 3 1/2"	50 pairs/200
C02422	5/16" x 1 3/4"	50 pairs/400
C02423	5/16" x 2 1/4"	50 pairs/400
C02424	5/16" x 3 1/2"	50 pairs/200

Closet Bolts



- Packed with acorn nuts and washers
- CARTON QUANTITIES ONLY
- Custom Packed

Brass Plated Bolts, Zinc Plated Washers and Acorn Nuts

Custom Packed - Two each bolts, nuts, washers and acorn nuts per bag

PART NO.	SIZE	WASHER	CTN/MSTR
C02000	1/4" x 1 3/4"	Oval	50 pairs/400
C02001	1/4" x 2 1/4"	Oval	50 pairs/400
C02002	1/4" x 3 1/2"	Oval	50 pairs/400
C02003	5/16" x 1 3/4"	Oval	50 pairs/400
C02004	5/16" x 2 1/4"	Oval	50 pairs/200
C02005	5/16" x 3 1/2"	Oval	50 pairs/200
C02010	1/4" x 1 3/4"	Round	50 pairs/400
C02011	1/4" x 2 1/4"	Round	50 pairs/400
C02012	1/4" x 3 1/2"	Round	50 pairs/200
C02013	5/16" x 1 3/4"	Round	50 pairs/400
C02014	5/16" x 2 1/4"	Round	50 pairs/200
C02015	5/16" x 3 1/2"	Round	50 pairs/200

Brass Bolts, Stainless Washers, Nickel Plated Acorn Nuts

Custom Packed - Two each bolts, nuts, washers and acorn nuts per bag

PART NO.	SIZE	WASHER	CTN/MSTR
C02020	1/4" x 1 3/4"	Oval	50 pairs/400
C02021	1/4" x 2 1/4"	Oval	50 pairs/400
C02022	1/4" x 3 1/2"	Oval	50 pairs/200
C02023	5/16" x 1 3/4"	Oval	50 pairs/200
C02024	5/16" x 2 1/4"	Oval	50 pairs/200
C02025	5/16" x 3 1/2"	Oval	50 pairs/200
C02029	1/4" x 1 3/4"	Round	50 pairs/200
C02030	1/4" x 2 1/4"	Round	50 pairs/400
C02031	1/4" x 3 1/2"	Round	50 pairs/200
C02032	5/16" x 1 3/4"	Round	50 pairs/200
C02033	5/16" x 2 1/4"	Round	50 pairs/200
C02034	5/16" x 3 1/2"	Round	50 pairs/200

Closest Bolts



- Packed with acorn nuts and washers
- CARTON QUANTITIES ONLY
- Bulk Packed

B

Brass Plated Bolts, Zinc Plated Washers and Acorn Nuts

Bulk Packed - One each bolt, nut, washer and acorn nut per bag

PART NO.	SIZE	WASHER	CTN/MSTR
C02000B	1/4" x 1 3/4"	Oval	100 each/400
C02001B	1/4" x 2 1/4"	Oval	100 each/400
C02002B	1/4" x 3 1/2"	Oval	100 each/400
C02003B	5/16" x 1 3/4"	Oval	100 each/400
C02004B	5/16" x 2 1/4"	Oval	100 each/400
C02005B	5/16" x 3 1/2"	Oval	100 each/400
C02010B	1/4" x 1 3/4"	Round	100 each/400
C02011B	1/4" x 2 1/4"	Round	100 each/400
C02012B	1/4" x 3 1/2"	Round	100 each/400
C02013B	5/16" x 1 3/4"	Round	100 each/400
C02014B	5/16" x 2 1/4"	Round	100 each/400
C02015B	5/16" x 3 1/2"	Round	100 each/400

Brass Bolts, Stainless Washers, Nickel Plated Acorn Nuts

Bulk Packed - One each bolt, nut, washer and acorn nut per bag

PART NO.	SIZE	WASHER	CTN/MSTR
C02020B	1/4" x 1 3/4"	Oval	100 each/400
C02021B	1/4" x 2 1/4"	Oval	100 each/400
C02022B	1/4" x 3 1/2"	Oval	100 each/400
C02023B	5/16" x 1 3/4"	Oval	100 each/400
C02024B	5/16" x 2 1/4"	Oval	100 each/400
C02025B	5/16" x 3 1/2"	Oval	100 each/400
C02029B	1/4" x 1 3/4"	Round	100 each/400
C02030B	1/4" x 2 1/4"	Round	100 each/400
C02031B	1/4" x 3 1/2"	Round	100 each/400
C02032B	5/16" x 1 3/4"	Round	100 each/400
C02033B	5/16" x 2 1/4"	Round	100 each/400
C02034B	5/16" x 3 1/2"	Round	100 each/400

Closest Bolt Component Parts



Closest Bolt

Closest Screw

Tinnerman Nut

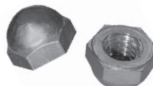

Close Acorn Nut



Open Acorn Nut



Oval Washer



Round Washer

PART NO.	DESCRIPTION	CTN/MSTR
C02800	1/4" x 1 3/4" brass plated closet bolt	100/1200
C02801	1/4" x 2 1/4" brass plated bolt	100/1200
C02802	1/4" x 3 1/2" brass plated bolt	100/700
C02803	5/16" x 1 3/4" brass plated bolt	100/700
C02804	5/16" x 2 1/4" brass plated bolt	100/800
C02805	5/16" x 3 1/2" brass plated bolt	100/500
C02820	1/4" x 1 3/4" brass bolt	100/1500
C02821	1/4" x 2 1/4" brass bolt	100/1200
C02822	1/4" x 3 1/2" brass bolt	100/700
C02823	5/16" x 1 3/4" brass bolt	100/1000
C02824	5/16" x 2 1/4" brass bolt	100/800
C02825	5/16" x 3 1/2" brass bolt	100/500
C02830	1/4" x 2 1/4" brass snap-off bolt	100/1000
C02832	5/16" x 2 1/4" brass snap-off bolt	100/800
C02808	1/4" x 2 1/2" brass plated screw	100/1000
C02815	1/4" x 3 1/2" brass plated screw	100/1000
C02811	5/16" x 2 1/2" brass plated screw	100/700
C02812	1/4" x 2 1/2" brass screw	100/800
C02813	1/4" x 3 1/2" brass screw	100/1000
C02814	5/16" x 2 1/2" brass screw	100/1000
C02807	5/16" tinnerman nut	100/3500
C02860	1/4" x 7/16" nickel plated open acorn nut	100/5000
C02861	1/4" x 7/16" zinc plated open acorn nut	100/5000
C02862	5/16" x 9/16" nickel plated open acorn nut	100/3000
C02863	5/16" x 9/16" zinc plated open acorn nut	100/3000
C02809	1/4" x 7/16" zinc plated closed acorn nut	100/2500
C02810	5/16" x 9/16" zinc plated closed acorn nut	100/4000
C02900	1/4" nickel plated closed acorn nut	100/2500
C02901	5/16" nickel plated closed acorn nut	100/4000
C02864	1/4" brass open acorn nut	100/2500
C02865	5/16" brass open acorn nut	100/4000
C02850	Oval stainless steel washer	100/5000
C02851	Oval zinc plated washer	100/4000
C02852	Round stainless steel washer	100/5000
C02853	Round zinc plated washer	100/5000

Snap-Off Closet Bolts



Counter Display

- Custom packed
- 2 each: Brass bolts, captive washers, nickel nuts, and stainless washers
- Available boxed or in counter display ("Bucket of Bolts")

Boxed

PART NO.	SIZE	WASHER	CTN/MSTR
C02040	1/4" x 2 1/4"	Oval	50 pairs/400
C02045	1/4" x 2 1/4"	Round	50 pairs/400
C02041	5/16" x 2 1/4"	Oval	50 pairs/200
C02046	5/16" x 2 1/4"	Round	50 pairs/200

Counter Display

PART NO.	SIZE	WASHER	CTN QTY
CB2040	1/4" x 3 1/2"	Oval	50 pairs
CB2045	1/4" x 3 1/2"	Round	50 pairs
CB2041	5/16" x 1 3/4"	Oval	50 pairs
CB2046	5/16" x 1 3/4"	Round	50 pairs

Closet Bolt - Elite Packs



- CARTON QUANTITIES ONLY

Packed with 4 acorn nuts and 4 washers

PART NO.	DESCRIPTION	CTN/MSTR
C02989	5/16" x 1 3/4" brass plated bolts	50 pairs/400
C02999	1/4" x 2 1/4" brass plated bolts	50 pairs/400
C02998	1/4" x 2 1/4" solid brass bolts	50 pairs/400
C02997	1/4" x 3 1/2" brass plated bolts	50 pairs/200
C02996	1/4" x 3 1/2" solid brass bolts	50 pairs/200
C02992	1/4" x 2 1/4" solid brass bolts	50 pairs/400
C02993	5/16" x 2 1/4" brass plated bolts	50 pairs/200

Packed with 2 acorn nuts, 2 hex nuts, and 4 washers

PART NO.	DESCRIPTION	CTN/MSTR
C02995	1/4" x 2 1/4" brass plated bolts	50 pairs/400
C02994	1/4" x 2 1/4" solid brass bolts	50 pairs/400

Packed with 2 acorn nuts, 2 hex nuts, 4 washers, and 2 tinnerman nuts

PART NO.	DESCRIPTION	CTN/MSTR
C02987	1/4" x 2 1/4" solid brass bolts	50 pairs/400

Closet Bolt Cap



Oval Cap

Round Cap

- CARTON QUANTITIES ONLY

Bulk Packed - Priced Per Cap And Washer

PART NO.	DESCRIPTION	CTN/MSTR
C02100	Oval white (less washer)	100/900
C02105	Round white (with washer)	100/2000
C02106	Round bone (with washer)	100/4000

Custom Packed - Priced Per Bag Of Two Each

PART NO.	DESCRIPTION	CTN/MSTR
C02103	Round white (with washer)	50 pairs/50
C02104	Round bone (with washer)	50 pairs/50

Closet Screws



With Round Washer

With Oval Washer

- CARTON QUANTITIES ONLY
- Two each screws, nuts, and washers per bag

Brass Plated

PART NO.	SIZE	WASHER	CTN/MSTR
C02210	1/4" x 2 1/2"	Round	50 pairs/400
C02202	1/4" x 3 1/2"	Round	50 pairs/200
C02211	5/16" x 2 1/2"	Round	50 pairs/200
C02200	1/4" x 2 1/2"	Oval	50 pairs/200
C02203	1/4" x 3 1/2"	Oval	50 pairs/200
C02201	5/16" x 2 1/2"	Oval	50 pairs/200

Brass

PART NO.	SIZE	WASHER	CTN/MSTR
C02310	1/4" x 2 1/2"	Round	50 pairs/400
C02302	1/4" x 3 1/2"	Round	50 pairs/400
C02311	5/16" x 2 1/2"	Round	50 pairs/200
C02300	1/4" x 2 1/2"	Oval	50 pairs/400
C02303	1/4" x 3 1/2"	Oval	50 pairs/200
C02301	5/16" x 2 1/2"	Oval	50 pairs/200

Tank to Bowl Set



- CARTON QUANTITIES ONLY
- Universal fit sponge rubber gasket
- Domed poly wingnut fits into china, eliminating bottom washer

PART NO.	DESCRIPTION	BOLT	CTN QTY
C03250	5/16" x 3"	Brass plated	25 pairs
C03251	5/16" x 3" with gasket	Brass plated	25 pairs
C03252	5/16" x 3"	Brass	25 pairs
C03253	5/16" x 3" with gasket	Brass	25 pairs

Tank To Bowl Bolt Set



- CARTON QUANTITIES ONLY
- Universal fit sponge rubber gasket

With Wing Nut

PART NO.	DESCRIPTION	BOLT	CTN/MSTR
C03200	5/16" x 3"	Brass plated	50 pairs/200
C03201	5/16" x 3" with gasket	Brass plated	25 pairs/200
C03202	5/16" x 3"	Brass	50 pairs/200
C03203	5/16" x 3" with gasket	Brass	25 pairs/200

With Hex Nut

PART NO.	DESCRIPTION	BOLT	CTN/MSTR
C03210	5/16" x 3"	Brass plated	50 pairs/200
C03211	5/16" x 3" with gasket	Brass plated	25 pairs/200
C03212	5/16" x 3"	Brass	50 pairs/200
C03213	5/16" x 3" with gasket	Brass	5 pairs/100

With Hex Nut and Wing Nut

PART NO.	DESCRIPTION	BOLT	CTN/MSTR
C03240	5/16" x 3"	Brass	50 pairs/100

Tank to Bowl Bolt Kit For Mansfield*



- Includes brass plated bolts, hex nuts, round washers, sponge rubber gasket and ballcock coupling nut

PART NO.	DESCRIPTION	CTN/MSTR
C03260	Mansfield* kit	1/25

Tank to Bowl Bolt Kit For Gerber*



- Includes brass bolts, hex nuts, round washers, sponge rubber gasket and ballcock coupling nut

PART NO.	DESCRIPTION	CTN/MSTR
C03265	Gerber* kit	1/25

Tank to Bowl Bolt Kit for American Standard*



- Includes bolts, nuts, round washers and sponge rubber gasket

PART NO.	DESCRIPTION	CTN/MSTR
C03270	American Standard* kit (brass plated bolts)	1/25
C03271	American Standard* (brass bolts)	1/25

Tri-Tank To Bowl Bolt Kit For American Standard*



- Brass plated

PART NO.	DESCRIPTION	CTN/MSTR
C03272	American Standard* Tank to Bowl Bolt Kit	1/25

Tri-Bolt Tank To Bowl Bolt Set



- For units requiring 3-bolt attachment
- Custom packed with 3 brass bolts, washers and hex nuts

PART NO.	DESCRIPTION	CTN/MSTR
C03280	5/16" x 3"	1/50

Offset Tank To Bowl Bolts



- All Brass
- Rubber washers
- 2" maximum adjustment

PART NO.	DESCRIPTION	CTN/MSTR
C02075	Offset tank to bowl bolts	50/200

Tank To Bowl Components



C03800



C03803



C03804



C03805



C03807



C03810



C02852

PART NO.	DESCRIPTION	CTN/MSTR
C03800	5/16"-18 x 3" brass plated tank bolt	100/500
C03801	5/16"-18 x 3" brass tank bolt	100/500
C03803	5/16"-18 brass plated forged wing nut	100/500
C03804	5/16"-18 brass plated heavy hex jam nut	100/5500
C03805	5/16"-18 brass heavy hex jam nut	100/5000
C03807	5/16" acetal tank bowl wing nut	100/3500
C03810	Cloth inserted washer	100
C02852	Stainless steel washer	100

Tank to Bowl Gasket



C03300



C03301



C03302



C03303



C03304



C03305

- Close coupled tank to bowl gaskets
- Beveled sponge rubber material
- CARTON QUANTITIES ONLY

Universal Fit-All

PART NO.	DESCRIPTION	CTN/MSTR
C03300	2 1/4" ID x 3 3/8" OD x 11/16" thick	25/1000

Kohler* (fits Alamo and other Kohler* integral units with two piece closets)

PART NO.	DESCRIPTION	CTN/MSTR
C03301	2 1/2" ID x 3 3/4" OD x 3/4" thick	25/1000

Eljer* (rubber)

PART NO.	DESCRIPTION	CTN/MSTR
C03302	2 5/16" ID x 3 1/8" OD x 3/8" thick	25/1000

American Standard Cadet*, Kohler*, Crane*, Borg Warner*

PART NO.	DESCRIPTION	CTN/MSTR
C03303	2 1/8" ID x 3 1/2" OD x 1 1/4" thick	25/300

Crane*

PART NO.	DESCRIPTION	CTN/MSTR
C03304	2 1/8" ID x 3 1/4" OD x 1 1/16" thick	25/300

Gerber* (free standing late models)

PART NO.	DESCRIPTION	CTN/MSTR
C03305	2 1/8" ID x 3 1/4" OD x 1 3/16" thick	25/300

Mansfield*

PART NO.	DESCRIPTION	CTN/MSTR
C03306	2 1/2" ID x 3 5/8" OD x 3/4" thick	25/200

Wax Gaskets



Standard Wax Gasket

With Plastic Flange

- Boxed
- CARTON QUANTITIES ONLY

PART NO.	DESCRIPTION	CTN/MSTR
G13001	Full size standard wax gasket	1/48
G13002	Gasket with plastic flange	1/24
G13003	Urinal gasket- fits 2" outlet	1/12
G13004	Jumbo wax gasket	1/12

Radiant Seal Sponge Rubber Closet Gasket



- Easy installation
- Unaffected by radiant heat
- Seals effectively with uneven floors
- 3 3/4" ID x 5 1/8" OD x 1/2" Thick

PART NO.	DESCRIPTION	CTN/MSTR
G13005	3 3/4" ID x 5 1/8" OD x 1/2" thick	1/12

Closet Bend Spacer



- One size fits all
- Eliminates the need to chip out concrete
- 6" OD x 4" high (fits 3" and 4" waste lines)
- Keeps poured concrete away from waste lines and closet bends
- Replaces styrofoam, styrene coverings, coffee cans and duct tape
- CARTON QUANTITIES ONLY

PART NO.	DESCRIPTION	CTN QTY
S12005	Closet bend spacer	18

Styrofoam Closet Flange Spacer



- Eliminates needless chipping of concrete
- Styrofoam breaks away or melts with flame
- Bulk pack- CARTON QUANTITIES ONLY

PART NO.	DESCRIPTION	CTN QTY
S13130	3" Flange spacer	120
S13140	4" Flange spacer	120

Foam Spacer



- Foam closet bend protector
- CARTON QUANTITIES ONLY

PART NO.	DESCRIPTION	CTN QTY
S13240	4"x 4" foam spacer	60

Shower Rod Flanges



• Flanges fit 15/16" and 1" OD rod

PART NO.	DESCRIPTION	CTN/MSTR
S02150	Jiffy flange chrome-plated plastic	1/200
S02151	Jiffy flange chrome die cast zinc	1/100
S02152	Chrome flanges with screws (bagged)	50/500

Jumbo Shower Bar Flange



PART NO.	DESCRIPTION	CTN/MSTR
S02300	Jumbo shower bar flange	1/50

Contoured Shower Rod



- Brings shower curtain in front of wall to prevent gaps and leaks
- Perfect for 60° oval or standard tubs
- Adjusts easily with tube cutter for shorter walls
- Sweeping curve increases space in center of oval tubs
- Sturdy alloy rods with zinc angled mounting brackets
- Multiple applications - residential, hotel, motel, assisted living, etc.

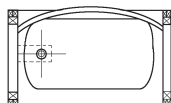

PART NO.	DESCRIPTION	CTN/MSTR
S02190	Chrome plated	1/12
S02193	Satin Nickel	1

Aluminum Shower Rod



- 1" OD - .025 wall (22 gauge)
- Individually wrapped
- CARTON QUANTITIES ONLY

PART NO.	DESCRIPTION	CTN QTY
S02055	5' rod	50
S02015	5' rod	10
S02056	6' rod	50
S02016	6' rod	10

Aluminum Shower Rod With Holders



- 1" OD - .025 wall (22 gauge)
- Fifty each Individually wrapped rods and holders boxed together
- 10 packs (S02071/-072/-073/-074)
- CARTON QUANTITIES ONLY

PART NO.	DESCRIPTION	CTN QTY
S02057	5' rod with plastic Jiffy flange	50
S02058	5' rod with die cast Jiffy flange	50
S02059	5' rod with chrome flange and screws	50
S02071	5' rod with chrome flange and screws	10
S02072	6' rod with chrome flange and screws	10
S02073	5' rod with plastic Jiffy flange	10
S02074	6' rod with plastic Jiffy flange	10

Adjustable Aluminum Shower Curtain Rod



- Sturdy, self-supporting
- 1" OD/.025 wall (22 gauge)
- Expandable from 58" to 61" or 69" to 73"
- Individually wrapped
- CARTON QUANTITIES ONLY

PART NO.	DESCRIPTION	CTN QTY
S02070	Adjustable shower rod 58" - 61" (bulk)	50
S02066	Adjustable shower rod 69" - 73" (bulk)	50
S02069	Adjustable shower rod 58" - 61" (10 pack)	10

Deluxe Shower Head



- 2.5 gpm flow rate
- Chrome plated die cast zinc

PART NO.	DESCRIPTION	CTN/MSTR
S01004	Deluxe shower head	1/100

Shower Heads



Plastic



Die cast



Brass

- 2.5 gpm flow rate

Plastic		
PART NO.	DESCRIPTION	CTN/MSTR
S01001	2" Chrome with plastic ball	1/100
S01002	2" White with plastic ball	1/200
S01003	2" Chrome with brass ball	1/100

Die Cast		
PART NO.	DESCRIPTION	CTN/MSTR
S01005	2" Chrome- adjustable	1/100

Brass		
PART NO.	DESCRIPTION	CTN/MSTR
S01008	1 3/4" Chrome- adjustable	1/50
S01009	2 1/8" Chrome- adjustable	1/50
S01010	3" Chrome- adjustable	1/20

Brass Aerating Water Saver Shower Head



Chrome

Chrome with Shutoff

- Permanent built-in water restrictor
- Mixes air and water for invigorating spray
- Restricts water to 2-2.5 gpm, depending on water pressure

PART NO.	DESCRIPTION	CTN/MSTR
S01013	1" Chrome	50/200
S01014	1" Chrome with shutoff	50/200

Vandal Proof Shower Head



- 2.5 gpm flow rate
- Brass ball
- Spray adjusts from coarse to fine
- Secures with set screw, hex key included

PART NO.	DESCRIPTION	CTN/MSTR
S01015	Chrome plated plastic shower head	1/100

Adjustable Plastic Shower Head



- 1.5 gpm flow rate
- Chrome plated plastic
- Brass ball

PART NO.	DESCRIPTION	CTN/MSTR
S01016	Chrome plated adjustable plastic shower head	1/100

Adjustable Massage Shower Head



- 2.5 gpm flow rate
- Brass ball

PART NO.	DESCRIPTION	CTN/MSTR
S01020	Chrome plated plastic shower head	1/100

Octagonal Shower Head



- 2.5 gpm flow rate
- Brass ball

PART NO.	DESCRIPTION	CTN/MSTR
S01025	Chrome plated octagonal shower head	25/100

Shower Arms and Kits



Shower Arm

Shower Arm with Flange

"S" Style Shower Arm

- Chrome plated brass arms

PART NO.	DESCRIPTION	CTN/MSTR
S01030	6" Arm only	1/200
S01032	8" Arm only	1/100
S01044	6" Arm and stainless steel flange	1/25
S01045	8" Arm and stainless steel flange	1/25
S01035	8" "S" style arm	10/80
S01038	10" "S" style arm	25/50

Heavy Adjustable Shower Arm



- 10" length
- Chrome plated brass
- Locking wing nut adjustment

PART NO.	DESCRIPTION	CTN/MSTR
S01039	1/2" x 10" adjustable	10/50

Shower Arm and Flange w/Set Screw



- 1/2" x 6" shower arm

PART NO.	DESCRIPTION	CTN/MSTR
S01042	6" Shower arm and flange w/set screw	1/25

Plastic Shower Arm



- 1/2" x 6" chrome-plated plastic with flange

PART NO.	DESCRIPTION	CTN/MSTR
S01049	Plastic shower arm and flange	1/200

Shower Arm Flange

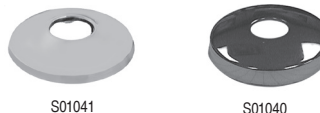

S01041

S01040

PART NO.	DESCRIPTION	CTN/MSTR
S01040	Chrome flange with set screw (2 1/2" OD)	40/400
S01041	Stainless steel flange (2 1/2" OD)	50/2000

Shower Curtain Pin



- CARTON QUANTITY ONLY

PART NO.	DESCRIPTION	CTN/MSTR
S02100	Shower curtain pin	10/500

Shower Pan Liner



- 40 mil thickness
- Meets ASTM D4551
- FREIGHT LINE ONLY
- PVC shower pan liner is listed by UPC
- Marked in 6 inch increments for easy measurements
- Treated to prevent the growth of fungus, molds and mildew



PART NO.	DESCRIPTION	CTN QTY
S994050	4' x 50'	1
S995040	5' x 40'	1
S996050	6' x 50'	1
S996080	5' x 80'	1

PVC Shower Pan Liner Cement



- 3 year shelf life
- Not for PE liner use
- Instant contact strength
- CARTON QUANTITY ONLY

PART NO.	DESCRIPTION	CTN QTY
S99100	Shower pan liner cement (pint)	12

Water Volume Control



- 1/2" female x 1/2" male IPS
- Allows reduced water flow (does not shut water completely off)

PART NO.	DESCRIPTION	CTN/MSTR
S01060	Chrome-brass	50/200
S01061	Chrome-plastic	1/25

Plastic Flow Restrictor



- 2.5 GPM

PART NO.	DESCRIPTION	CTN/MSTR
S01080	Shower head flow restrictor	1/25

54" D-Style Add-A-Shower

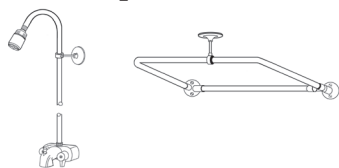

- Heavy duty jumbo flanges
- 61" riser with shower head
- Standard bathcock (3 3/8" centers)
- 54" x 27" chrome plated brass shower rod (1" diameter)

PART NO.	DESCRIPTION	CTN/MSTR
S10083	54" x 27" D-Style Add-A-Shower	1/5

Add-A-Shower Complete Unit

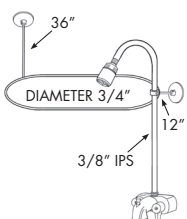

- Bathcock with diverter spout
- Chrome plated plastic shower head
- 61" rise with 12" rod and riser support
- 24" x 42" rectangular aluminum shower rod with 36" ceiling rod and support

PART NO.	DESCRIPTION	CTN/MSTR
S10070	Complete unit with S10080 diverter	1/5
S10069	Complete unit with S10074 diverter	1/5

Complete Add-A-Shower

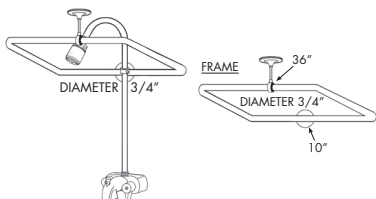

- Rectangular frame
- Aluminum shower rod
- Bathcock with diverter spout
- 3/8" mounting brackets included
- 61" riser with 10" rod and riser support

PART NO.	DESCRIPTION	CTN/MSTR
S10067	Shower with 24" x 42" frame	1/5
S10068	24" x 42" Frame only	1

Add-A-Shower Less Oval Shower Rod

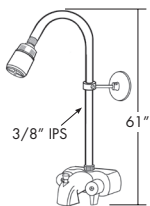

- 61" riser and wall support
- Bathcock with diverter spout
- Chrome plated plastic shower head

PART NO.	DESCRIPTION	CTN/MSTR
S10072	Complete unit	1/10

Add-A-Shower Diverter Spout & Riser

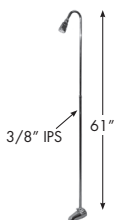

- Diverter valve
- 61" riser with wall support
- Chrome plated plastic shower head

PART NO.	DESCRIPTION	CTN/MSTR
S10071	Spout and riser	1/10

Add-A-Shower Code Pattern

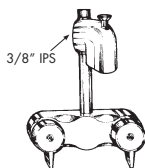

PART NO.	DESCRIPTION	CTN QTY
S10074	Code pattern anti-syphon diverter bathcock	1

Add-A-Shower Accessories

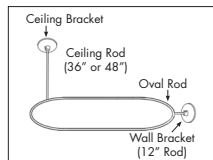

PART NO.	DESCRIPTION	CTN/MSTR
S10075	24" x 42" oval shower rod	1/10
B60001	Wall bracket and rod holder with 12" rod (can be cut to fit)	1/100
B60002	Ceiling bracket and rod holder with standard size 36" rod	1/100
S10073	48" ceiling rod only	1
S10080	Replacement Bathcock Assembly	1/12
S10081	Diverter spout only for S10071	1/50
S10077	Wall bracket for S10071	1/200
S10078	Diverter spout with 65" riser	1/10
S10082	61" CP brass riser only	1/20
S10076	61" CP brass riser with shower head	1/10

Shower Diverter Valve



- Installs between arm and shower head
- Allows usage of hand-held personal shower or shower head

PART NO.	DESCRIPTION	CTN/MSTR
S01070	Chrome push button- brass	1/5

Offset Bath Supplies

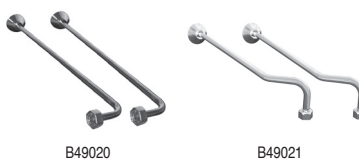

- Chrome plated
- 1/2" supply tubes
- All hardware needed for connection included

PART NO.	DESCRIPTION	CTN/MSTR
B49020	Single offset (pair)	1/25
B49021	Double offset (pair)	1/25
B49022	Replacement nuts, washers and escutcheons	1/25

Utility Shower



- 21" galvanized riser
- Top or bottom connection
- Chrome plated brass body with shower head and soap dish
- Combination 1/2" threaded or sweat connection union inlets on 3" centers

PART NO.	DESCRIPTION	CTN/MSTR
S10079	Utility shower	1/6

Bathcocks



B49001



B49002



B49010

- Chrome plated brass body
- Replaceable stem and seat
- 3 3/8" centers and 3/4" threaded inlets

PART NO.	DESCRIPTION	CTN/MSTR
B49001	"O" pattern with slip-on spout	1/48
B49002	Code pattern with goose neck spout	1/48
B49010	Coupling elbows (pair) chrome plated 3/4" bath-cock threads x 1/2" male IPS	6/60
B49011	Code spout only	1/10
B49012	Hot repair kit (handle, stem and seat)	1/100
B49013	Cold repair kit (handle, stem and seat)	1/100

Brass Trap Bushing



- Heavy pattern/cast
- 1 1/2" sweat x 1 1/2" IPS
- Knurled end for ease of tightening

PART NO.	DESCRIPTION	CTN/MSTR
B55150	1 1/2" SWT x 1 1/2" MIP	1/250

Twin Elbow And Face Bushings



FIP x FIP



MIP x FIP

• Brass

PART NO.	DESCRIPTION	CTN/MSTR
D01040	3/4" FIP x 1/2" FIP twin elbow	1/144
D01041	3/4" MIP x 1/2" FIP face bushing	1/1000
D01042	1/2" MIP x 3/8" FIP face bushing	1/40

Brass Shower Elbow For Fiberglass Shower Stall



- Outlet 1/2" FIP
- Secures tub spout nipple
- Secures shower arm to stall
- Lock nuts secure ell to fiberglass wall
- Requires 1 1/8" hole through fiberglass wall
- Combination inlet 1/2" female sweat or 1/2" threaded

PART NO.	DESCRIPTION	CTN/MSTR
S01050	Brass elbow	6/144

Diverter Spouts and Extensions



D01001
D01004
D01101
D01104



D01002
D01003
D01103

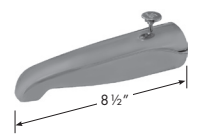

D01015



D01008
D01009



D01030
D01031



D01010



D01011

- D01002 and D01004 Meets IAPMO and California Energy Commission approval

Chrome Plated Diverter Spouts

PART NO.	DESCRIPTION	CONNECTION	MATERIAL	CTN/MSTR
D01001	1/2" FIP	Nose	Zamak	1/50
D01002	3/4" x 1/2" FIP	Base	Zamak	1/50
D01003	3/4" x 1/2" FIP	Base	Brass	1/50
D01004	1/2" CTS slide connection (unit includes hex key)	Base	Zamak	1/50

8 1/2" One Piece Diverter Spouts

PART NO.	DESCRIPTION	CONNECTION	MATERIAL	CTN/MSTR
D01015	3/4" x 1/2" FIP	Base	Brass	1/20

Two Piece Diverter Spouts

PART NO.	DESCRIPTION	CONNECTION	MATERIAL	CTN QTY
D01008	8 1/4" two piece	Nose	Zamak	1
D01009	10 1/8" two piece	Nose	Zamak	1

Extension Only

PART NO.	DESCRIPTION	CONNECTION	MATERIAL	CTN/MSTR
D01030	3" extension only	-	CP Brass	1/100
D01031	4 3/4" extension only	-	CP Brass	1/80

Diverter Spout For Hand Held Shower- 1/2" MIP Hookup

PART NO.	DESCRIPTION	CONNECTION	MATERIAL	CTN/MSTR
D01010	3/4" x 1/2" FIP top hookup	Base	Zamak	1/50
D01011	3/4" x 1/2" MIP lower hookup	Base	Zamak	1/50

Chrome Plated Diverter Spout

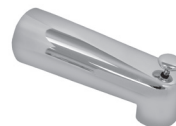

- Longer length for today's larger tubs
- CTS unit comes with hex key

PART NO.	SIZE	CONNECTION	CTN/MSTR
D01024	7"	1/2" FIP Nose	1/50
D01025	7"	1/2" CTS Slide	1/25

Chrome Plated Slip-On Diverter Spout With Polished Brass Knob

B



- Hex key included
- Polished brass knob
- Standard 5 1/2" diverter spout
- 1/2" CTS slip-on connection with set screw

PART NO.	DESCRIPTION	CTN/MSTR
D01032	Slip-On Diverter Spout With PB Knob	1/50

Tub Spouts

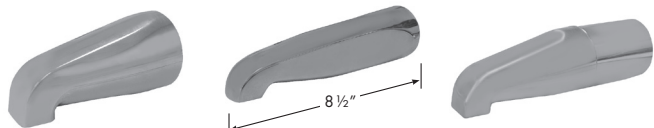

Chrome Plated Zamak Slide Connection With Hex Key

PART NO.	DESCRIPTION	CONNECTION	MATERIAL	CTN/MSTR
D01020	1/2" FIP	Nose	CP Zamak	1/50
D01021	1/2" CTS slide connection	Base	CP Zamak	1/50

8 1/2" One Piece Chrome Plated Brass

PART NO.	DESCRIPTION	CONNECTION	MATERIAL	CTN/MSTR
D01016	3/4" x 1/2" FIP	Base	CP brass	1/20

Two Piece Chrome Plated

PART NO.	DESCRIPTION	CONNECTION	MATERIAL	CTN	QTY
D01028	8" two piece	Nose	Zamak	1	
D01029	10" two piece	Nose	Zamak	1	

Telescoping Tub and Diverter Spouts



- 5 1/2" overall length
- Adjustment up to 1" to accommodate various rough-ins

PART NO.	DESCRIPTION	CTN/MSTR
D01022	1/2" x 3/4" tub spout	1/50
D01023	1/2" x 3/4" diverter spout	1/50

9" Chrome Plated Tub Spouts



- One piece design
- 1/2" nose connection
- Solid brass construction

PART NO.	DESCRIPTION	CTN/MSTR
D01017	9" CP brass diverter spout	1/12
D01018	9" CP brass tub spout	1/12

7" Chrome Plated Tub Spout



- CTS unit comes with hex key
- Longer length for today's larger tubs

PART NO.	SIZE	CONNECTION	CTN/MSTR
D01026	7"	1/2" FIP Nose	1/50
D01027	7"	1/2" CTS Slide	1/25

Tub Spout



Solid Brass

Zinc

Solid brass

PART NO.	SIZE	CONNECTION	CTN/MSTR
D01005	3/4" x 1/2"	Base	1/40

Zinc

PART NO.	SIZE	CONNECTION	CTN/MSTR
D01035	1/2" x 3/4"	Base	1/25

Overflow Plates

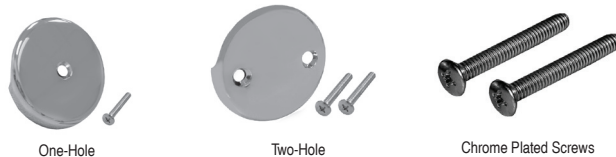

One-Hole

Two-Hole

Chrome Plated Screws

- Chrome plated
- 2" screws
- UPC listed

PART NO.	DESCRIPTION	CTN/MSTR
T05012	One-hole with screw	20/200
T05013	Two-hole with screws	20/200
T05010	One-hole less screw	20/200
T05011	Two-hole less screw	20/200
T05021	1/4" x 2" chrome plated screw	500/2000

Tub Trip Levers With Spring

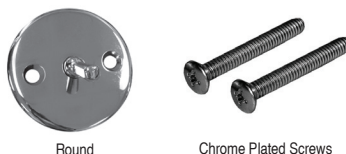

Round

Chrome Plated Screws

- Chrome plated
- Coil-type spring
- 2" screws

PART NO.	DESCRIPTION	CTN/MSTR
T05002	Round trip lever less screws	25/200
T05003	Round trip lever with 2" screws	25/200
T05021	1/4" x 2" chrome plated screw	500/2000

Face Plate Gasket And Shoe Gasket

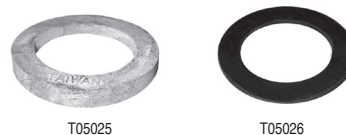

T05025

T05026

PART NO.	DESCRIPTION	CTN/MSTR
T05025	Beveled face plate gasket 2 1/8" ID x 3 3/16" OD - 9/16"-3/16" thick	25/300
T05026	Shoe gasket 1 3/4" ID x 2 5/8" OD - 3/32" thick	25/50

Wraparound Sponge Rubber Face Plate Gasket



- Grips top elbow for easy installation

PART NO.	DESCRIPTION	CTN/MSTR
T05029	Wraparound sponge rubber face gasket	25/500

#15 Plumb Kit



- Stainless steel flange (S01041)
- 1/2" x 6" chrome plated brass shower arm (S01030)
- Chrome plated plastic shower head with brass ball (S01003)

PART NO.	DESCRIPTION	CTN/MSTR
S03220	#15 Plumb kit	1/25

#51 Plumb Kit



- Chrome plated flange with set screw (S01040)
- 1/2" x 6" chrome plated brass shower arm (S01030)
- Chrome plated die cast adjustable shower head (S01005)

PART NO.	DESCRIPTION	CTN/MSTR
S03222	#51 Plumb kit	1/25

Bathtub Protectors

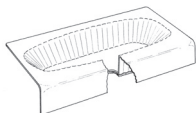

- High impact plastic
- Fluted side walls and foam bottom
- CARTON QUANTITIES ONLY
- MOTOR FREIGHT (LTL) ONLY

For Steel Tubs

PART NO.	DESCRIPTION	CTN QTY
T10014	14" deep x 60" long x 30" wide	35

For Oval Tubs

PART NO.	DESCRIPTION	CTN QTY
T10016	16" deep x 60" long x 42" wide	25

For Cast Iron Tubs

PART NO.	DESCRIPTION	CTN QTY
T10216	16" deep x 60" long x 30" wide	35

Adapter Bushing For Bath Drain



- Brass bushing

PART NO.	DESCRIPTION	CTN/MSTR
T05023	Kohler Bushing	50/300
T05024	1 1/2" MIP x 1 3/8" FIP	50/300

Standard Waste And 1-Hole Overflow

Half Kit With Chrome Plated Lift And Turn



- 2-hole test kit converts to one hole face plate

PART NO.	DESCRIPTION	CTN/MSTR
B07220T	Waste and overflow kit- PVC	1/24
B07221T	Waste and overflow kit- ABS	1/24

Standard Waste And 2-Hole Overflow

Half Kit With Satin Nickel Lift And Turn



- 2-hole face plate

PART NO.	DESCRIPTION	CTN/MSTR
B07111S	Waste and Overflow kit- ABS	1/24
B07114S	Waste and Overflow kit- PVC	1/24

Standard Waste And Overflow

Full Kit With Chrome Plated Friction Lift



- Includes bar
- 1-hole face plate

PART NO.	DESCRIPTION	CTN/MSTR
B07219	Waste and overflow Kit- PVC	1/10

Lift And Turn Bath Drain



- Chrome plated
- 2 11/16" OD flange

PART NO.	DESCRIPTION	CTN/MSTR
P35061	1 3/8" bath drain (1 5/8" thread OD) zinc body	1/100
P35060	1 1/2" bath drain (1 7/8" thread OD) zinc body	1/100
P35066	1 1/2" bath drain (1 7/8" thread OD) brass	1/100

Friction Lift Tub Drain



- Chrome plated zinc

PART NO.	DESCRIPTION	CTN/MSTR
P35067	1 1/2" bath drain	1/100
P35077	1 3/8" CP Friction Lift Tub Drain	1/100

Chrome Plated Grid Drain Body With Screw



- Chrome plated zinc

PART NO.	DESCRIPTION	CTN/MSTR
P35064	1 1/2" CP grid drain	1/100

Toe Touch Bath Drain



- Chrome plated zinc

Bath Drain

CP Replacement Drain

PART NO.	DESCRIPTION	CTN/MSTR
P35063	1 3/8" bath drain (1 5/8" thread OD)	1/100
P35062	1 1/2" bath drain (1 7/8" thread OD)	1/100
P35056	5/16" CP replacement cartridge	1/300
P35057	3/8" CP replacement cartridge	1/250

Roman Tub Drains



- Solid brass construction
- Screws are included
- U-shaped handle design
- Designed to fit D64 series "Code Blue" drains

PART NO.	DESCRIPTION	CTN/MSTR
D40000	CP Roman Tub Drain	1/50
D40001	PB/PVD Roman Tub Drain	1/50
D40002	Satin Nickel PVD Roman Tub Drain	1/50

Basin And Tub Stopper



- White hollow rubber with rustproof ring

PART NO.	TRADE SIZE	TOP	BOTTOM	CTN/MSTR
P35125	1 1/4"	1 3/8"	1 3/16"	100/500
P35150	1 1/2"	1 5/8"	1 3/8"	100/500
P35158	1 5/8"	1 25/32"	1 19/32"	100/500
P35175	1 3/4"	1 55/64"	1 11/16"	100/500

Fit-All Stopper



Part No.	Top	Bottom
P35-160	1 1/2"	7/8"
P35-161	3"	1 1/2"

- White rubber construction

PART NO.	DESCRIPTION	CTN/MSTR
P35160	1" - 1 3/8" basin stopper	100/500
P35161	1 1/2" - 2" bathtub or laundry tub stopper	100/500

Pop-Up Basin Stopper



P36002



P36003



P36004

PART NO.	DESCRIPTION	CTN/MSTR
P36002	Delta pop-up basin stopper	1/50
P36003	Price-Pfister pop-up stopper	1/200
P36004	Moen pop-up basin stopper	1/200

Flip-It Tub Stopper



- No tools needed for installation
- Open or close with a flip of the toe
- One piece construction of Derlin and ABS
- Fits most popular tub drains (assorted o-rings included)

PART NO.	DESCRIPTION	CTN/MSTR
P35070	Chrome plated Flip-it	1/100

Flip-It Conversion Kit



- No bending or stooping necessary to operate
- Open or close with a flip of the toe
- Fits most popular tub drains

PART NO.	DESCRIPTION	CTN QTY
P35170	Chrome plated Flip-It Conversion kit	1

Schedule 40 Bath Waste Kits - Expanded Views

*See pages B22 - B23 for a complete list of available Schedule 40 Bath Waste Kits

Standard **One-Hole** Schedule 40 Bath Waste Kits

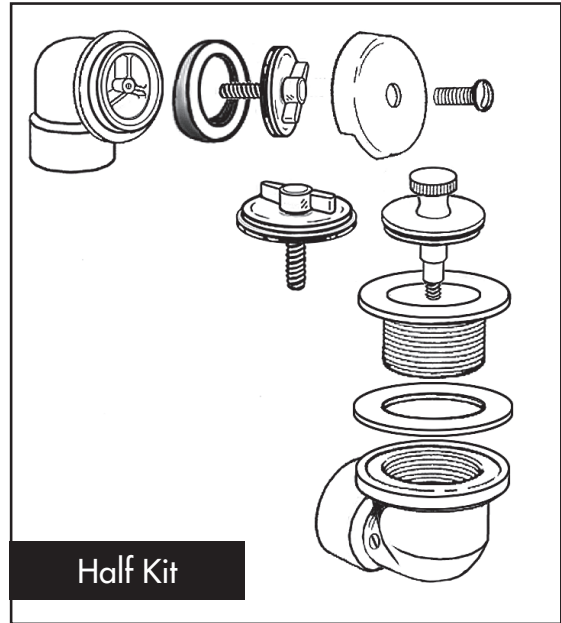
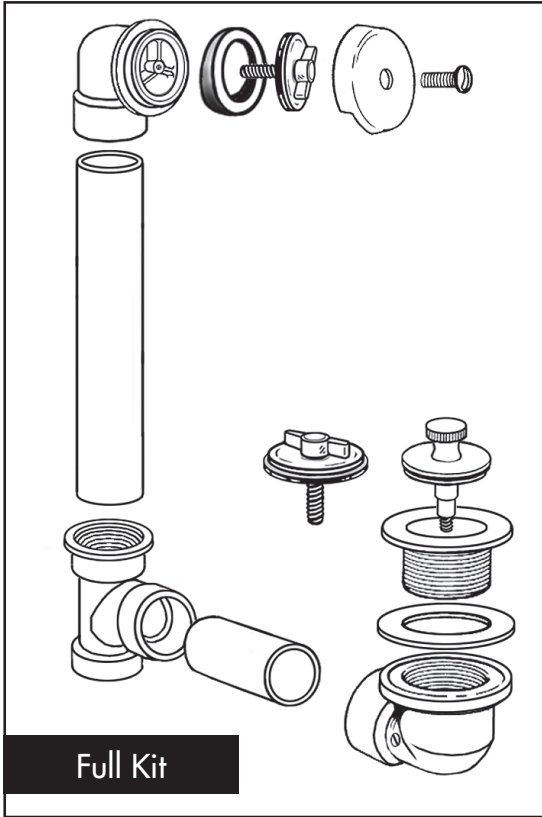

Standard **Two-Hole** Schedule 40 Bath Waste Kits

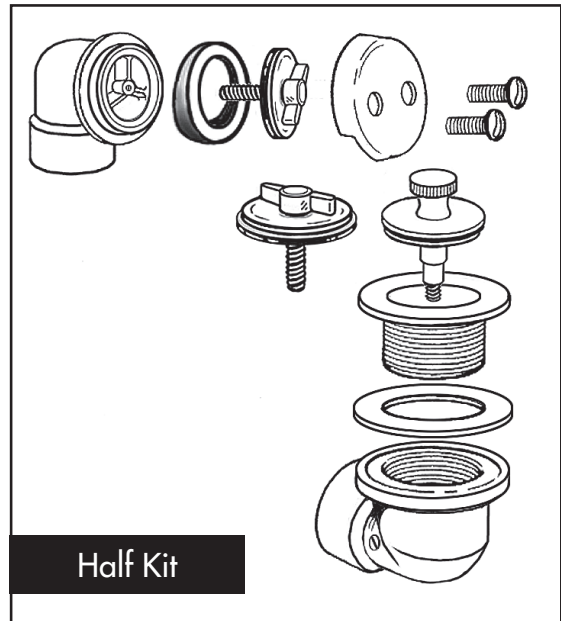
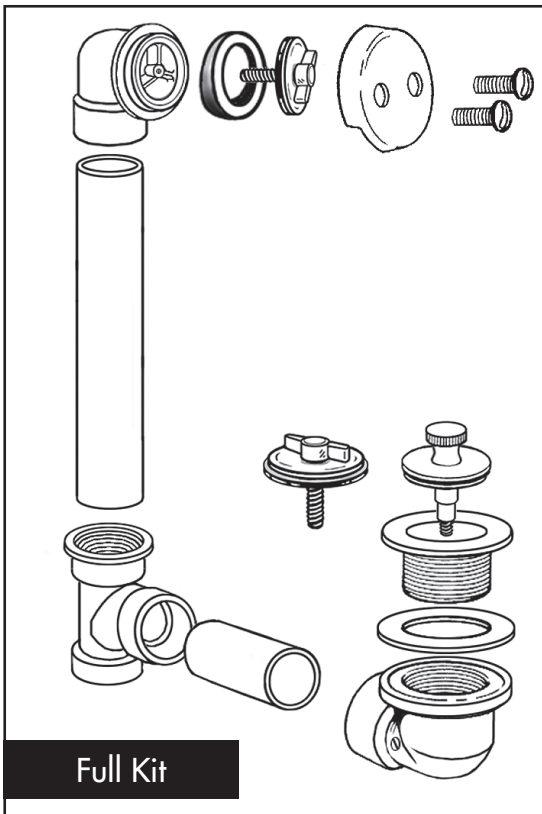

B

Schedule 40 Direct Waste Bath Kits

With One-Hole Face Plates

For use in apartments, motels, hotels - anywhere with back to back baths



T-Waste Kit Benefits:

- Direct access to trap from tub
- Direct waste much less likely to clog
- Solvent weld = homogeneous
- Code required for back to back installation
- Never needs access through walls or ceilings

- NO ACCESS PANEL NEEDED!
- UPC listed
- One-hole face plates
- Bolt holes on top elbows are pre-threaded
- All drains 3/8" thread size for testing

Note: Please use suffix "T" when ordering any waste and overflow kit to have test kit included. Add \$4.99 to list price. When a complete kit with a two-hole test kit is ordered, a one-hole face plate with aluminum conversion bar will be supplied.



Half Kit - Lift & Turn Drain



Half Kit - Toe Pop-Up Drain

T-Waste Half Kit- No Pipe Or Elbow

PART NO.	MATERIAL	DESCRIPTION	CTN/MSTR
B07038	PVC	CP brass lift and turn drain	1/24
B07001	PVC	CP lift and turn drain	1/24
B07005	PVC	PB lift and turn drain	1/24
B07003	PVC	CP toe pop-up drain	1/24
B07007	PVC	PB toe pop-up drain	1/24
B07040	PVC	CP friction lift drain	1/24
B07042	PVC	PB friction lift drain	1/24
B07006	ABS	PB lift and turn drain	1/24
B07039	ABS	CP brass lift and turn drain	1/24
B07002	ABS	CP lift and turn drain	1/24
B07004	ABS	CP toe pop-up drain	1/24
B07008	ABS	PB toe pop-up drain	1/24
B07041	ABS	CP friction lift drain	1/24
B07043	ABS	PB friction lift drain	1/24



Full Kit - Lift & Turn Drain



Full Kit - Toe Pop-Up Drain

T-Waste Full Kit- Includes Pipe And 90° Elbow

PART NO.	MATERIAL	DESCRIPTION	CTN/MSTR
B07044	PVC	CP brass lift and turn drain	1/10
B07020	PVC	CP lift and turn drain	1/10
B07024	PVS	PB lift and turn drain	1/10
B07022	PVC	CP toe pop-up drain	1/10
B07046	PVC	CP friction lift drain	1/10
B07048	PVC	PB friction lift drain	1/10
B07045	ABS	CP brass lift and turn drain	1/10
B07021	ABS	CP lift and turn drain	1/10
B07025	ABS	PB lift and turn drain	1/10
B07023	ABS	CP toe pop-up drain	1/10
B07027	ABS	PB toe pop-up drain	1/10
B07047	ABS	CP friction lift drain	1/10
B07049	ABS	PB friction lift drain	1/10

Schedule 40 Direct Waste Bath Kits

With Two-Hole Face Plates

For use in apartments, motels, hotels - anywhere with back to back baths



T-Waste Kit Benefits:

- Direct access to trap from tub
- Direct waste much less likely to clog
- Solvent weld = homogeneous
- Code required for back to back installation
- Never needs access through walls or ceilings

- NO ACCESS PANEL NEEDED!
- UPC listed
- Two-hole face plates
- Bolt holes on top elbow are pre-threaded
- All drains 3/8" thread size for testing

Note: Please use suffix "T" when ordering any waste and overflow kit to have test kit included. Add \$4.99 to list price. When a complete kit with a two-hole test kit is ordered, a one-hole face plate with aluminum conversion bar will be supplied.



Half Kit - Lift & Turn Drain



Half Kit - Toe Pop-Up Drain

T-Waste Half Kit- No Pipe Or Elbow

PART NO.	MATERIAL	DESCRIPTION	CTN/MSTR
B07138	PVC	CP brass lift and turn drain	1/24
B07101	PVC	CP lift and turn drain	1/24
B07105	PVC	PB lift and turn drain	1/24
B07103	PVC	CP toe pop-up drain	1/24
B07107	PVC	PB toe pop-up drain	1/24
B07140	PVC	CP friction lift drain	1/24
B07142	PVC	PB friction lift drain	1/24
B07139	ABS	CP brass lift and turn drain	1/24
B07102	ABS	CP lift and turn drain	1/24
B07106	ABS	PB lift and turn drain	1/24
B07104	ABS	CP toe pop-up drain	1/24
B07108	ABS	PB toe pop-up drain	1/24
B07141	ABS	CP friction lift drain	1/24
B07143	ABS	PB friction lift drain	1/24



Full Kit - Lift & Turn Drain



Full Kit - Toe Pop-Up Drain

T-Waste Full Kit- Includes Pipe And 90° Elbow

PART NO.	MATERIAL	DESCRIPTION	CTN/MSTR
B07144	PVC	CP brass lift and turn drain	1/10
B07120	PVC	CP lift and turn drain	1/10
B07124	PVC	PB lift and turn drain	1/10
B07122	PVC	CP toe pop-up drain	1/10
B07126	PVC	PB toe pop-up drain	1/10
B07146	PVC	CP friction lift drain	1/10
B07148	PVC	PB friction lift drain	1/10
B07121	ABS	CP lift and turn drain	1/10
B07125	ABS	PB lift and turn drain	1/10
B07123	ABS	CP toe pop-up drain	1/10
B07127	ABS	PB toe pop-up drain	1/10
B07147	ABS	CP friction lift drain	1/10
B07149	ABS	PB friction lift drain	1/10

Schedule 40 Bath Waste Kits

With One-Hole Face Plates



- UPC listed
- One-hole face plates
- Bolt holes on top elbows are pre-threaded
- All drains 3/8" thread size for testing

Note: Please use suffix "T" when ordering any waste and overflow kit to have test kit included. Add \$4.99 to list price. When a complete kit with a two-hole test kit is ordered, a one-hole face plate with aluminum conversion bar will be supplied.



Half Kit - Lift & Turn Drain

Half Kit - Toe Pop-Up Drain

Standard Half Kit- No Pipe Or Elbow

PART NO.	MATERIAL	DESCRIPTION	CTN/MSTR
B07050	PVC	CP brass lift and turn drain	1/24
B07010	PVC	CP lift and turn drain	1/24
B07014	PVC	PB lift and turn drain	1/24
B07012	PVC	CP toe pop-up drain	1/24
B07016	PVC	PB toe pop-up drain	1/24
B07052	PVC	CP friction lift drain	1/24
B07054	PVC	PB friction lift drain	1/24
B07051	ABS	CP brass lift and turn drain	1/24
B07011	ABS	CP lift and turn drain	1/24
B07015	ABS	PB lift and turn drain	1/24
B07013	ABS	CP toe pop-up drain	1/24
B07017	ABS	PB toe pop-up drain	1/24
B07053	ABS	CP friction lift drain	1/24
B07055	ABS	PB friction lift drain	1/24



Full Kit - Lift & Turn Drain



Full Kit - Toe Pop-Up Drain

Standard Full Kit- Includes Pipe And Tee PVC

PART NO.	MATERIAL	DESCRIPTION	CTN/MSTR
B07056	PVS	CP brass lift and turn drain	1/10
B07030	PVC	CP lift and turn drain	1/10
B07034	PVC	PB lift and turn drain	1/10
B07032	PVC	CP toe pop-up drain	1/10
B07036	PVC	PB toe pop-up drain	1/10
B07058	PVC	CP friction lift drain	1/10
B07060	PVC	PB friction lift drain	1/10
B07057	ABS	CP brass lift and turn drain	1/10
B07031	ABS	CP lift and turn drain	1/10
B07035	ABS	PB lift and turn drain	1/10
B07033	ABS	CP toe pop-up drain	1/10
B07037	ABS	PB toe pop-up drain	1/10
B07059	ABS	CP friction lift drain	1/10
B07061	ABS	PB friction lift drain	1/10

Schedule 40 Bath Waste Kits

With Two-Hole Face Plates



- UPC listed
- Two-hole face plates
- Bolt holes on top elbow are pre-threaded
- All drains 3/8" thread size for testing

Note: Please use suffix "T" when ordering any waste and overflow kit to have test kit included. Add \$4.99 to list price. When a complete kit with a two-hole test kit is ordered, a one-hole face plate with aluminum conversion bar will be supplied.



Half Kit - Lift & Turn Drain

Half Kit - Toe Pop-Up Drain

Standard Half Kit- No Pipe Or Tee

PART NO.	MATERIAL	DESCRIPTION	CTN/MSTR
B07150	PVC	CP brass lift and turn drain	1/24
B07110	PVC	CP lift and turn drain	1/24
B07114	PVC	PB lift and turn drain	1/24
B07112	PVC	CP toe pop-up drain	1/24
B07116	PVC	PB toe pop-up drain	1/24
B07152	PVC	CP friction lift drain	1/24
B07154	PVC	PB friction lift drain	1/24
B07151	ABS	CP brass lift and turn drain	1/24
B07111	ABS	CP lift and turn drain	1/24
B07115	ABS	PB lift and turn drain	1/24
B07113	ABS	CP toe pop-up drain	1/24
B07117	ABS	PB toe pop-up drain	1/24
B07153	ABS	CP friction lift drain	1/24
B07155	ABS	PB friction lift drain	1/24



Full Kit - Lift & Turn Drain



Full Kit - Toe Pop-Up Drain

Standard Full Kit- Includes Pipe Or Tee

PART NO.	MATERIAL	DESCRIPTION	CTN/MSTR
B07156	PVC	CP brass lift and turn drain	1/10
B07130	PVS	CP lift and turn drain	1/10
B07134	PVC	PB lift and turn drain	1/10
B07132	PVC	CP toe pop-up drain	1/10
B07136	PVC	PB toe pop-up drain	1/10
B07158	PVC	CP friction lift drain	1/10
B07160	PVC	PB friction lift drain	1/10
B07157	ABS	CP brass lift and turn drain	1/10
B07131	ABS	CP lift and turn drain	1/10
B07135	ABS	PB lift and turn drain	1/10
B07133	ABS	CP toe pop-up drain	1/10
B07137	ABS	PB toe pop-up drain	1/10
B07159	ABS	CP friction lift drain	1/10
B07161	ABS	PB friction lift drain	1/10

B

Waste And Overflow Test Kits



• Drain thread size is 3/8"

PART NO.	DESCRIPTION	CTN/MSTR
B07201	One-hole waste and overflow test kit	1/200
B07202	Two-hole waste and overflow test kit	1/200

Aluminum Bar For Waste And Overflow



- Holds overflow ell to tub
- Converts two-hole faceplate to one-hole faceplate

PART NO.	DESCRIPTION	CTN/MSTR
B07200	Aluminum bar with 2 screws	1/500
B07203	One-hole overflow face plate with aluminum bar	1

Bath Waste Trim Kits



B07071 One Hole Trim Kits



B07171 Two Hole Trim Kits



Lift & Turn Stopper

One-Hole

PART NO.	DESCRIPTION	CTN QTY
B07071	Overflow plate trim kit with CP lift and turn stopper	1
B07073	Overflow plate trim kit with CP friction lift stopper	1

Two-Hole

PART NO.	DESCRIPTION	CTN QTY
B07171	Overflow plate trim kit with CP lift and turn stopper	1
B07173	Overflow plate trim kit with CP friction lift stopper	1

One Hole Polished Brass Face Plate Trim Kit



- Overflow plate, screws and lift and turn stopper
- PVD finish

PART NO.	DESCRIPTION	CTN QTY
B08071	1 Hole PB face plate trim kit	1

Conversion Kits With Cross Bar



- Includes cross bar
- 1- Hole face plate
- 1 3/8" chrome plated zinc drain
- Includes bushing for 1 1/2" installation

PART NO.	DESCRIPTION	CTN QTY
B51019	CP lift and turn conversion kit	1
B51020	PB lift and turn conversion kit	1
B07210	CP friction lift conversion kit	1

Trip Lever Trim



- Trip lever overflow plate, screws and strainer

PART NO.	DESCRIPTION	CTN/MSTR
B51014	Chrome trip lever trim only	5/25

Trip Lever Conversion Kit



- Trip lever overflow plate, screws, strainer assembly and brass adapter

PART NO.	DESCRIPTION	CTN/MSTR
B51015	Chrome trip lever conversion kit	5/25

Bath Waste Conversion Kits



- Carded for display
- B51006, B51008, B51011 are 1 1/2" kits
- All others are 1 1/2"x 1 3/8" and include bushings

2-Hole Kits

PART NO.	DESCRIPTION	CTN QTY
B51005	CP lift and turn kit	1
B51006	White lift and turn kit	1
B51007	CP pop-up kit	1
B51008	CP friction lift kit	1

1-Hole Kits

PART NO.	DESCRIPTION	CTN QTY
B51009	CP lift and turn kit	1
B51010	CP pop-up kit	1
B51011	CP friction lift kit	1

Schedule 40 Bath Waste Rough-In Kits



One-Hole Rough In Kits B07070
*(Shown with Test Kit)

One-Hole

PART NO.	MATERIAL	DESCRIPTION	CTN QTY
B07074	PVC	Std. rough-in kit w/ CP lift & turn drain body	1
B07374	ABS	Std. rough-in kit w/ CP lift & turn drain body	1
B07075	PVC	Std. rough-in kit w/ CP friction lift drain body	1
B07375	ABS	Std. rough-in kit w/ CP friction lift drain body	1

Two-Hole

PART NO.	MATERIAL	DESCRIPTION	CTN QTY
B07076	PVC	Std. rough-in kit w/ CP lift & turn drain body	1
B07376	ABS	Std. rough-in kit w/ CP list & turn drain body	1
B07077	PVC	Std. rough-in kit w/ CP friction lift drain body	1
B07377	ABS	Std. rough-in kit w/ CP friction lift drain body	1

Schedule 40 Bath Waste Rough-In Kits With Test Kits



Two-Hole Rough In Kits B07170
*(Shown with Test Kit)

*One-Hole			
PART NO.	MATERIAL	DESCRIPTION	CTN QTY
B07070	PVC	Std. rough-in kit w/ CP lift & turn drain body & test kit	1
B07470	ABS	Std. rough-in kit w/ CP lift & turn drain body & test kit	1
B07072	PVC	Std. rough-in kit w/ CP friction lift drain body & test kit	1
B07472	ABS	Std. rough-in kit w/ CP friction lift drain body & test kit	1
*Two-Hole			
PART NO.	MATERIAL	DESCRIPTION	CTN QTY
B07170	PVC	Std. rough-in kit w/ CP lift & turn drain body & test kit	1
B07476	ABS	Std. rough-in kit w/ CP lift & turn drain body & test kit	1
B07172	PVC	Std. rough-in kit w/ CP friction lift drain body & test kit	1
B07477	ABS	Std. rough-in kit w/ CP friction lift drain body & test kit	1

Grab Bar With Exposed Flange



Satin Finish



Peened Finish

- 18 gauge stainless steel
- Meets 900 lb. downward pull when installed properly
- Meets federal specification WW-P-541/8B, Amendment 1, 16 April 1990
- Meets ANSI 1171 and all ADA Code requirements
- Meets federal specifications for FHA, VA hospital, private construction
- Individually bagged with stainless steel mounting screws

Satin Finish		
PART NO.	DESCRIPTION	CTN/MSTR
G12012	1 1/4" x 12"	1/5
G12016	1 1/4" x 16"	1/5
G12018	1 1/4" x 18"	1/5
G12024	1 1/4" x 24"	1/5
G12030	1 1/4" x 30"	1/5
G12032	1 1/4" x 32"	1/5
G12036	1 1/4" x 36"	1/5
G12042	1 1/4" x 42"	1/5
G12048	1 1/4" x 48"	1/5
G13012	1 1/2" x 12"	1/5
G13016	1 1/2" x 16"	1/5
G13018	1 1/2" x 18"	1/5
G13024	1 1/2" x 24"	1/5
G13030	1 1/2" x 30"	1/5
G13032	1 1/2" x 32"	1/5
G13036	1 1/2" x 36"	1/5
G13042	1 1/2" x 42"	1/5
G13048	1 1/2" x 48"	1/5

Grab Bar With Exposed Flange (cont.)



Satin Finish



Peened Finish

- 18 gauge stainless steel
- Meets 900 lb. downward pull when installed properly
- Meets federal specification WW-P-541/8B, Amendment 1, 16 April 1990
- Meets ANSI 117.1 and all ADA Code requirements
- Meets federal specifications for FHA, VA hospital, private construction
- Individually bagged with stainless steel mounting screws

Peened Finish		
PART NO.	DESCRIPTION	CTN/MSTR
G12212	1 1/4" x 12"	1/5
G12216	1 1/4" x 16"	1/5
G12218	1 1/4" x 18"	1/5
G12224	1 1/4" x 24"	1/5
G12230	1 1/4" x 30"	1/5
G12232	1 1/4" x 32"	1/5
G12236	1 1/4" x 36"	1/5
G12242	1 1/4" x 42"	1/5
G12248	1 1/4" x 48"	1/5
G13212	1 1/2" x 12"	1/5
G13216	1 1/2" x 16"	1/5
G13218	1 1/2" x 18"	1/5
G13224	1 1/2" x 24"	1/5
G13230	1 1/2" x 30"	1/5
G13232	1 1/2" x 32"	1/5
G13236	1 1/2" x 36"	1/5
G13242	1 1/2" x 42"	1/5
G13248	1 1/2" x 48"	1/5

Grab Bar With Concealed Snap-On Flange



Satin Finish



Peened Finish

- 18 gauge stainless steel
- Meets 900 lb. downward pull when installed properly
- Meets federal specification WW-P-541/8B, Amendment 1, 16 April 1990
- Meets ANSI 117.1 and all ADA Code requirements
- Meets federal specifications for FHA, VA hospital, private construction
- Individually bagged with stainless steel mounting screws

Satin Finish		
PART NO.	DESCRIPTION	CTN/MSTR
G12112	1 1/4" x 12"	1/5
G12116	1 1/4" x 16"	1/5
G12118	1 1/4" x 18"	1/5
G12124	1 1/4" x 24"	1/5
G12130	1 1/4" x 30"	1/5
G12132	1 1/4" x 32"	1/5
G12136	1 1/4" x 36"	1/5
G12142	1 1/4" x 42"	1/5
G12148	1 1/4" x 48"	1/5
G13112	1 1/2" x 12"	1/5
G13116	1 1/2" x 16"	1/5
G13118	1 1/2" x 18"	1/5
G13124	1 1/2" x 24"	1/5
G13130	1 1/2" x 30"	1/5
G13132	1 1/2" x 32"	1/5
G13136	1 1/2" x 36"	1/5
G13142	1 1/2" x 42"	1/5
G13148	1 1/2" x 48"	1/5

Grab Bar With Concealed Snap-On Flange (cont.)

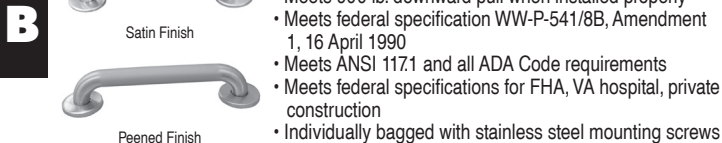

- 18 gauge stainless steel
- Meets 900 lb. downward pull when installed properly
- Meets federal specification WW-P-541/8B, Amendment 1, 16 April 1990
- Meets ANSI 117.1 and all ADA Code requirements
- Meets federal specifications for FHA, VA hospital, private construction
- Individually bagged with stainless steel mounting screws

Peened Finish

PART NO.	DESCRIPTION	CTN/MSTR
G12312	1 1/4" x 12"	1/5
G12316	1 1/4" x 16"	1/5
G12318	1 1/4" x 18"	1/5
G12324	1 1/4" x 24"	1/5
G12330	1 1/4" x 30"	1/5
G12332	1 1/4" x 32"	1/5
G12336	1 1/4" x 36"	1/5
G12342	1 1/4" x 42"	1/5
G12348	1 1/4" x 48"	1/5
G13312	1 1/2" x 12"	1/5
G13316	1 1/2" x 16"	1/5
G13318	1 1/2" x 18"	1/5
G13324	1 1/2" x 24"	1/5
G13330	1 1/2" x 30"	1/5
G13332	1 1/2" x 32"	1/5
G13336	1 1/2" x 36"	1/5
G13342	1 1/2" x 42"	1/5
G13348	1 1/2" x 48"	1/5

Grab Bar Fastening Systems



- G12998
- Made of stainless steel screws and fire retardant plastic
 - Installs in minutes in any wall
 - Will hold up to 600 lbs. per grab bar

- G12999
- Made of stainless steel
 - Will hold up to 1000 lbs. per grab bar
 - Blocking/studs are not required

- S02999
- Will not be visible when installed
 - Prevents shower rod sag
 - Will not loosen over time

PART NO.	DESCRIPTION	CTN/MSTR
G12998	Residential Grab Bar Wing It	1/50
G12999	Commercial Grab Bar Wing It	1/60
S02999	Crescent Rod Wing It	1/50

Brass Pop-up Assembly/Replacement Parts



- All metal construction
- Tool free locknut and ballrod nut
- 17 gauge

PART NO.	DESCRIPTION	CTN/MSTR
P35001	Chrome-brass	1/50

Replacement Parts

PART NO.	DESCRIPTION	CTN/MSTR
P35041	1 1/4" Mack Gasket	1/500
P35900	Universal plastic plunger with CP brass cap	1/25
P35901	CP brass flange	16/800
P35902	Flat rubber washer	1/25
P35904	Polyethylene washer	1/1000
P35905	Brass locknut	1/25
P35906	CP brass drain body	1/250
P35907	CP brass tailpiece	1/250
P35908	Brass lift rod	1/500
P35909	Steel clevis with thumb screw	1/25
P35910	Stainless steel spring clip	1/2000
P35911	CP brass ball nut	1/600
P35912	CP steel ball rod with plastic all (6 3/8" long)	1/150
P35913	Friction washer- under nut (not visible)	1/600

Lift & Lock Pop-Up



With overflow holes

PART NO.	DESCRIPTION	CTN/MSTR
P35000	CP Lift & Lock pop-up w/ overflow holes	1/50

Without overflow holes

PART NO.	DESCRIPTION	CTN/MSTR
P35003	CP Lift & Lock pop-up w/o overflow holes	1/50

ABS Pop-Up Assembly



PART NO.	DESCRIPTION	CTN/MSTR
P35004	Grey plastic	6/30

Chrome Plated ABS Pop-Up Assembly



PART NO.	DESCRIPTION	CTN/MSTR
P35005	Chrome plated plastic	6/30

Brass P.O. Plug Drain



- With chain and stopper

PART NO.	DESCRIPTION	CTN/MSTR
D70103	1 1/4" P.O. plug drain	1/50

Trap Primer Tailpiece



T74010



T74011

- 17 gauge tubular chrome plated steel
- Sturdy one-piece construction eliminates leaks and crossthreading

PART NO.	DESCRIPTION	CTN/MSTR
T74010	1 1/4" x 8" - threaded top	1/50
T74011	1 1/2" x 8" - slip joint top direct connection	1/50

Commercial P-Trap with Cleanout



- Carded
- Brass nuts
- Chrome plated
- 17 gauge semi-cast P-trap
- 17 gauge tubular wall bend

PART NO.	DESCRIPTION	CTN/MSTR
J37124	1 1/4" OD with cleanout	1/12
J37150	1 1/2" OD with cleanout	1/12

Chrome Plated PVC P-Trap



- Complete with nuts, washers and escutcheon

PART NO.	DESCRIPTION	CTN/MSTR
P36102	1 1/4"	1/50
P36103	1 1/2"	1/50

Handicap Style Lav Drain



- Twin 90° construction
- Polished chrome plated brass
- Mack washer and brass locknut
- 17 gauge 1 1/4" tailpiece; cast brass elbows

PART NO.	DESCRIPTION	CTN/MSTR
D70101	Handicap drain	1/25
D70104	One piece tubular elbow	1/25

Commercial Handicap Drain With Elbow



- 1 1/4" female thread
- Complete with gaskets and brass locknut
- Polished chrome plated brass; cast brass elbow

PART NO.	DESCRIPTION	CTN/MSTR
D70102	Handicap drain with elbow	1/25

Commercial Grid Drain Without Overflow Holes



- 17 gauge
- For vessel sinks

PART NO.	DESCRIPTION	CTN/MSTR
D70105	CP grid drain	1/25

Commercial Lav Drain



- Polished chrome plated brass
- Mack washer and brass locknut
- 17 gauge 1 1/4" tailpiece; 6" long

PART NO.	DESCRIPTION	CTN/MSTR
D70100	Commercial lav drain	1/50

Flush Valve Pipe Support



- 1 1/2" OD size
- 5" center of pipe to wall
- Chrome plated split ring type
- Mounting hardware included

PART NO.	DESCRIPTION	CTN/MSTR
F39800	1 1/2" x 5" pipe support	10/100
F39700	1 1/2" x 3 1/2" pipe support	10/100

Tissue Rollers

- CARTON QUANTITIES ONLY



PART NO.	DESCRIPTION	CTN/MSTR
B10195	Fit-All white plastic	25/200

Provent



- Manufactured housing and RV's only
- Automatic anti-siphon trap vent used as secondary venting
- Must be located at least 60" above trap arm
- Two individually protected fixtures may be connected to same 1 1/2" drain
- Three or more fixtures must be drained by 2" line
- Simply hand tighten, no thread seal needed
- Water closet must have main stack to outside
- Must be installed in accessible location with free flow air
- Do not install in sealed wall cavity
- 1 1/2" MPT threads

PART NO.	DESCRIPTION	CTN/MSTR
P21150	1 1/2" Provent	1/50

Air Gap



- Prevents sewage backflow by breaking siphoning action in drain line
- White polypro body with chrome plated ABS top
- UPC approved

PART NO.	DESCRIPTION	CTN QTY
A10001	Air Gap	36/72

Air Gap Spacer



PART NO.	DESCRIPTION	CTN/MSTR
A10901	Air gap spacer	1/25

Air Gap Dishwasher Kit



- Contains air gap, 24" dishwasher hose (7/8"), and two gear clamps
- Poly bagged and labeled

PART NO.	DESCRIPTION	CTN/MSTR
A10100	Air gap installation pack	1/10
A10200	Air gap installation pack-white	1/10
A10150	Air gap deluxe pack (includes dishwasher elbow and vacuum breaker)	1/10

Plumb Aire Air Vent



- Up to 160 fixture units
- May be exposed to temperatures ranging from -40 ° + 150°F
- No protective cover required when installed per code specifications
- Back pressure rated to 20 PSI

PVC

PART NO.	DESCRIPTION	CTN/MSTR
P21100	Plumb Aire vent- 1 1/2"x 2"	1/20
P21101	Plumb Aire vent with adapter	1/20

ABS

PART NO.	DESCRIPTION	CTN/MSTR
P21102	Plumb Aire vent - 1 1/2"x 2"	1/20
P21103	Plumb Aire vent with adapter	1/20

PVC Adapter For Air Inlet Valve

PART NO.	DESCRIPTION	CTN/MSTR
P21104	PVC adapter for air inlet valve	1/20
P21107	ABS adapter for air inlet valve	1/20

Rosettes

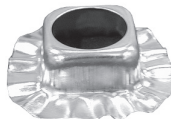

- CARTON QUANTITIES ONLY

PART NO.	DESCRIPTION	CTN/MSTR
B10110	Shallow pattern (zinc plated)	25/5000
B10111	Deep pattern (zinc plated)	25/1000

Basin Cock Locknut



- CARTON QUANTITIES ONLY

PART NO.	DESCRIPTION	CTN/MSTR
B10080	1/2" - 14 hex locknut	25/1000
B10081	1/2" - 14 flanged hex locknut	25/750

Basket Strainer Locknuts & Washers



- Die cast zinc
- CARTON QUANTITIES ONLY

PART NO.	DESCRIPTION	CTN/MSTR
B10090	1 1/2" locknut	25/350
B10091	2" locknut	25/350
B10092	3 3/8" locknut for 4" duo strainer	25/350
B10093	3 3/8" heavy pattern locknut for 4" duo strainer	25/100
B10094	Basket strainer rubber washer (4 7/16" OD)	25/300

Fiber Friction Washer

PART NO.	DESCRIPTION	CTN/MSTR
D02002	Basket strainer friction washer (4 3/16" OD) [Fiber Friction Washer]	1/100

Ballcock Coupling Nut And Locknut



- CARTON QUANTITIES ONLY

PART NO.	DESCRIPTION	CTN/MSTR
C05080	5/8" x 1 1/2" 7 threads zinc die cast	25/500
C05081	5/8" x 7/8" brass	25/500
C05082	15/16" - 14 locknut	25/500

Plastic Slip Joint Nut



- White
- CARTON QUANTITIES ONLY (T85125 and T85150)

PART NO.	DESCRIPTION	CTN/MSTR
T83150	1 1/2" with wings	100/1200
T85125	1 1/4" x 1 1/4"	100/1200
T85150	1 1/2" x 1 1/2"	100/1200

Basin Nut



• CARTON QUANTITIES ONLY

PART NO.	DESCRIPTION	CTN/MSTR
B10100	1/2" - 14 x 3/8" regular Zamak	25/500
B10102	1/2" - 14 x 1/2" regular Zamak	25/500
B10103	1/2" - 14 x 9/16" regular Zamak	25/500
B10104	1/2" - 14 x 9/16" regular brass	25/1000

Plastic Lavatory Supply Nut



• Wing nut design
• CARTON QUANTITIES ONLY

PART NO.	DESCRIPTION	CTN/MSTR
B10105	1/2" - 14 x 1/2" white faucet nut	25/1100

Sink Connection Washer



PART NO.	DESCRIPTION	CTN/MSTR
T79000	1 3/4" x 1 3/8" x 1/8"	100/1000

Split Nut



• Replace fractured or stripped slip nuts without tubular disassembly
• Supplied with washer

PART NO.	DESCRIPTION	CTN/MSTR
T82125	1 1/4" split nut	100/400
T82150	1 1/2" split nut	100/400

Slip Joint Nut



• CARTON QUANTITIES ONLY

Die Cast Zinc		
PART NO.	IPS x SLIP TUBE	CTN/MSTR
T77125	1 1/4" x 1 1/4"	25/500
T77138	1 1/2" x 1 3/8"	25/300
T77150	1 1/2" x 1 1/2"	25/300
T77151	1 1/2" x 1 1/4"	25/300
T77152	2" x 1 1/2"	25/300
T77200	2" x 2"	25/200
Chrome Plated Brass		
PART NO.	IPS x SLIP TUBE	CTN/MSTR
T78125	1 1/4" x 1 1/4"	25/400
T78150	1 1/2" x 1 1/2"	25/400
T78151	1 1/2" x 1 1/4"	25/400
T78152	2" x 1 1/2"	25/400
T78200	2" x 2"	25/400

Rough Brass Slip Joint Nut



• Heavy cast brass
• CARTON QUANTITIES ONLY

PART NO.	IPS x SLIP TUBE	CTN/MSTR
T84125	1 1/4" x 1 1/4"	25/300
T84150	1 1/2" x 1 1/2"	25/300
T84151	1 1/2" x 1 1/4"	25/300
T84200	2" x 2"	25/300

Slip Joint Washer



Square Cut Rubber



Poly Beveled

• CARTON QUANTITIES ONLY

Square Cut Rubber		
PART NO.	NUT x TUBE	CTN/MSTR
T79125	1 1/4" x 1 1/4"	100/5600
T79150	1 1/2" x 1 1/2"	100/5600
T79151	1 1/2" x 1 1/4"	100/5600
T79200	2" x 2"	100/2400
T79201	2" x 1 1/2"	100/2400
Poly Beveled		
PART NO.	NUT x TUBE	CTN/MSTR
T80125	1 1/4" x 1 1/4"	100/5000
T80150	1 1/2" x 1 1/2"	100/5000
T80151	1 1/2" x 1 1/4"	100/5000
T80200	2" x 2"	100/5000

Slip Joint Nut And Washer



Die Cast Nut



Brass Nut

• Chrome plated nut packed with square cut rubber washer
• CARTON QUANTITIES ONLY

Die Cast Nut		
PART NO.	DESCRIPTION	CTN/MSTR
T77014	1 1/4" x 1 1/4"	25/500
T77012	1 1/2" x 1 1/2"	25/500
T77013	1 1/2" x 1 1/4"	25/500
T77020	2" x 2"	25/500
Brass Nut		
PART NO.	DESCRIPTION	CTN/MSTR
T78014	1 1/4" x 1 1/4"	25/400
T78012	1 1/2" x 1 1/2"	25/400
T78013	1 1/2" x 1 1/4"	25/400
T78020	2" x 2"	25/400

Cone Slip Joint Washer

- Black
- CARTON QUANTITIES ONLY

B

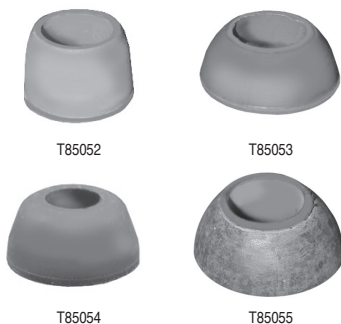

PART NO.	NUT	TUBE	OD x ID	CTN/MSTR
T85050	1/2"	3/8"	23/32" x 3/8"	100/1600
T85051	1/2"	3/8" threaded	23/32" x 3/8"	100/1600
T85052	1/2"	7/16" or 1/2"	5/8" x 7/16"	100/1600
T85053	Ballcock supply -	-	3/4" x 7/16"	100/1600
T85054	Ballcock supply -	-	13/16" x 11/32"	100/1600
T85055	Upper bath supply -	-	27/32" x 7/16"	100/1600

Brass Friction Rings

- CARTON QUANTITIES ONLY (T85-125 and T85-150)



PART NO.	NUT	TUBE	OD x ID	CTN QTY
T86050	1/2"	3/8"	21/32" x 25/64"	100
T86052	1/2"	7/16"	21/32" x 29/64"	100
T86053	Ballcock	1/2"	13/16" x 17/32"	100
T86054	Ballcock	3/8"	13/16" x 25/64"	100
T86055	Ballcock	7/16"	13/16" x 15/32"	100

Flanged Poly Tailpiece Washer

- CARTON QUANTITIES ONLY



PART NO.	NUT x TUBE	CTN QTY
T81150	1 1/2" x 1 1/2"	100
T79152	1 1/2" x 1 1/4" cloth inserted	100

Waste Connector



- Brass body ferrule and nut
- MIP units are combination female sweat

FIP x SLIP		
PART NO.	DESCRIPTION	CTN/MSTR
T75125	1 1/4" FIP x 1 1/4" OD	12/72
T75150	1 1/2" FIP x 1 1/2" OD	12/72
T75151	1 1/2" FIP x 1 1/4" OD	12/72
T75250	1 1/2" FIP x 1 1/2" OD with poly washer	12/72
MIP x SLIP		
PART NO.	DESCRIPTION	CTN/MSTR
T76125	1 1/4" MIP x 1 1/4" OD	12/72
T76150	1 1/2" MIP x 1 1/2" OD	12/72
T76151	1 1/2" MIP x 1 1/4" OD	12/72
T76250	1 1/2" MIP x 1 1/2" OD with poly washer	12/72
Brass Compression Ring		
PART NO.	DESCRIPTION	CTN/MSTR
T75000	1 1/4" OD	1/1000
T75001	1 1/2" OD	1/1000

Double Slip Fittings



- Chrome plated brass
- 22 gauge

PART NO.	DESCRIPTION	CTN/MSTR
T74001	1 1/4" Coupling	10/100
T74002	1 1/2" Coupling	10/100
T74003	1 1/4" 90° Ell	10/100
T74004	1 1/2" 90° Ell	10/100
T74005	1 1/4" 45° Ell	10/100
T74006	1 1/2" 45° Ell	10/100

Slip Joint Tee

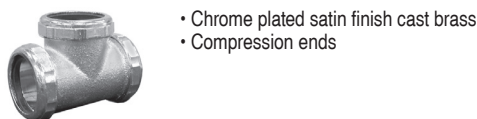

- Chrome plated satin finish cast brass
- Compression ends

PART NO.	DESCRIPTION	CTN/MSTR
C74105	1 1/2" x 1 1/2" x 1 1/2" tee	10/60

90° Drop Ear Elbow



• Cast brass

PART NO.	DESCRIPTION	CTN/MSTR
B55000	1/2" FIP x 1/2" FSWT	60/240
B55100	1/2" FIP x 1/2" FIP	45/180
B55103	1/2" FSWT x 1/2" FSWT	1/100

LEAD FREE

PART NO.	DESCRIPTION	CTN/MSTR
B55050	1/2" FIP x 1/2" FSWT	60/240

90° Drop Ear Elbow



• Cast brass

PART NO.	DESCRIPTION	CTN/MSTR
B55104	3/4" FIP x 3/4" FSWT	1/100

90° Drop Ear Transition Elbow



• Cast brass
• Fits CPVC connection
• Permanent joint

PART NO.	DESCRIPTION	CTN/MSTR
B55101	1/2" FIP x 1/2" CPVC socket	1/25

Sweat Male Adapter/Marvel Rings



Sweat Male Adapter



Marvel Adapter

• Use on tub spout ell or closet/urinal stub out adapter

Sweat Male Adapter

PART NO.	FSWT x MIP	CTN/MSTR
B55001	1/2" x 1/2"	1/1000
B55002	3/4" x 3/4"	1/1000
B55003	1" SJ x 1" SWT	1/1000

Marvel Adapter

PART NO.	FSWT x MIP	CTN/MSTR
B55004	1 1/4" SJ x 1 1/4" SWT	1/1000
B55005	1 1/2" SJ x 1 1/2" SWT	1/500
B55006	2" SJ x 2" SWT	1/500
B55007	1 1/2" SJ x 1 1/4" SWT	1/500
B55008	1 1/2" SJ x 1 1/2" Tubular	1/500
B55009	1 1/4" SJ x 1 1/4" Tubular	1/500

Assorted Washer Kit



• 210 pieces packaged in reusable plastic case
• Available with flat or beveled washers
• Contains: 40-00, 40-0, 40-1/4, 30-1/4 large, 20-3/8, 20-3/8 medium, 10-3/8 large, 10-1/2 large

PART NO.	DESCRIPTION	CTN/MSTR
J40150	Beveled washer kit	12/24
J40151	Flat washer kit	12/24

O-Ring Kit And Pick



O25200

O25199

• Packed in resealable plastic case with fitting chart on lid
• Manufactured from nitrile compound
• Made in the USA

PART NO.	DESCRIPTION	CTN/MSTR
O25200	200 pc plumber's pack	12/24
O25199	O-ring pick	1/25

Solid Brass Bibb Screw Assortment Kit



• 208 pieces packaged in reusable plastic case
• Contains: 3/8" x 6-32, 1/2" x 6-32, 3/8" x 8-32, 1/2" x 8-32, 3/8" x 10-24, 1/2" x 6-24, 3/8" x 10-32, 1/2" x 10-32

PART NO.	DESCRIPTION	CTN/MSTR
J40153	Bibb screw assortment	10/40

Faucet Seat Kit



• Made in USA
• Reusable compartment box with seat guide on inside cover
• Kit B40000 contains all 36 seats
• Kit B40101 contains: B40002, B40005, B40006, B40015, B40020, B40028

MADE IN THE
USA

PART NO.	DESCRIPTION	CTN/MSTR
B40000	144-piece faucet seat kit (36 different parts)	1/4

Faucet Seats

- All brass
- Made in the USA

MADE IN THE
USA

B



PART NO.	FITS BRAND/SIZE	CTN/MSTR
B40001	Speakman 9/16" x 28 x 3/8"	1/100
B40003	Speakman 7/16" x 27 x 11/32"	1/100
B40002	American Standard 7/16" x 24 x 13/32"	1/100
B40004	American Standard 9/16" x 24" x 3/8"	1/100
B40012	American Standard 1/2" x 20 x 3/8"	1/100
B40013	American Standard 1/2" x 20 x 7/16"	1/100
B40021	American Standard 9/16" x 18 x 3/8"	1/100
B40031	American Standard 1/2" x 20 x 5/8"	1/100
B40005	Price Pfister 1/2" x 20" x 3/8"	1/100
B40006	Price Pfister .65" x 18 x 3/8"	1/100
B40007	Briggs, RPCL 1/2" x 24 x 7/16"	1/100
B40008	Briggs, RPCL 9/16" x 20 x 3/8"	1/100
B40023	Briggs 5/8" x 20 x 13/16"	1/100
B40035	Briggs, Republic 5/8" x 24 x 7/16"	1/100
B40009	Repal 9/16" x 28 x 11/32"	1/100
B40010	Eljer 1/2" x 27 x 1/2"	1/100
B40026	Eljer 1/2" x 20 x 3/8"	1/100
B40011	Kohler 1/2" x 27 x 3/8"	1/100
B40028	Kohler 1/2" x 27 x .318"	1/100
B40027	Kohler Push-In x .348"	1/100
B40014	Central Brass 9/16" x 27 x 13/32"	1/100
B40018	Central Brass 1/2" x 24 x .418"	1/100
B40019	Central Brass 5/8" x 24 x 23/32"	1/100
B40015	Sterling 1/2" x 24 x 3/8"	1/100
B40017	Universal 17/32" x 24 x 3/8"	1/100
B40020	Gerber 5/8" x 20 x 27/64"	1/100
B40024	Dick Brothers 1/2" x 27 x 13/32"	1/100
B40025	Indiana Brass 1/2" x 27 x 13/32"	1/100
B40034	Indiana Brass 9/16" x 27 x 5/8"	1/100
B40030	Union Brass 5/8" x 18 x 5/16"	1/100
B40033	Union Brass 5/8" x 18 x 29/32"	1/100
B40032	Sayco 1/2" x 20 x 5/16"	1/100
B40036	Steamway 1/2" x 24 x 11/32"	1/100

Cock Hole Cover

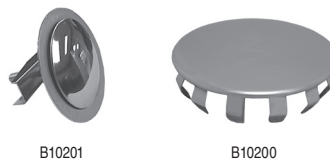

- Stainless steel
- CARTON QUANTITIES ONLY

PART NO.	DESCRIPTION	CTN/MSTR
B10201	1 3/4" OD with washer	25/500
B10202	2" OD with washer	25/500
B10200	1 1/2" snap in	25/1200

Plastic Faucet Hole Cover



- 1 3/4" OD
- Push-in style/ white plastic
- CARTON QUANTITIES ONLY

PART NO.	DESCRIPTION	CTN/MSTR
B10203	1 3/4" OD	100/1200

Long Reach Bar Tap Faucet



- 1/4" connection
- 10" meets NSF 61.9
- Lead Free

PART NO.	DESCRIPTION	CTN/MSTR
B45014	Long reach bar tap faucet	5/50

Bar Tap Faucet



- Meets NSF standard 61.9
- 1/4" compression inlet connection
- Chrome plated brass faucets individually bagged
- Kit includes: stem, spring, 2 "o" rings and black handle
- Lead Free

PART NO.	DESCRIPTION	CTN/MSTR
B45010	1/4" connection	1/36

Kitchen Hose And Spray (Fit All)



K52001



K52002

- Reinforced hose with universal coupling adapter
- Individually boxed for display
- Automatic off
- Replacement for thumb controlled sink spray



K52004



K52010

PART NO.	DESCRIPTION	CTN/MSTR
K52001	Head only	1/200
K52002	Head, hose and adapter	1/50
K52003	4' hose and adapter	1/100
K52004	Hose guide	1/500
K52010	White hose and spray	1/100
K52005	White head only	50/200

Rinse-Quik Hose And Spray



Complete Spray Head Assembly



Spray Head



Pet Sprayer

- Made in the USA
- Individually boxed

PART NO.	DESCRIPTION	RQ #	CTN/MSTR
K53001	Black spray assembly complete	(MR4224)	1/50
K53005	White spray assembly complete	(MR-4224WH)	1/50
K53006	Black spray assembly with 1/4" female swivel nut to fit Delta faucet	(MR422-4C)	1/50
K53002	Black spray head only w/ chrome ring	(MR4-22)	1/100
K53003	4' hose only	(MR-4)	1/50
K53004	Hose guide	(MR-200)	1/10
K53007	Replacement hose for Delta	(MR4C)	1/100
K53008	White spray head only w/ chrome ring	(MR422WH)	1/100
K53056	Black spray head with black ring	(MR427)	1/100
K53057	White spray head assembly	(MR4274WH)	1/100
K53058	White spray head with white ring	(MR427WH)	1/100
K53055	Black spray head assembly	(MR42474)	1
K53077	Black spray head assembly with 6' hose	-	1
K53060	Pet Sprayer	(MR421)	1

Delta Style Spray Assembly



K55006



K55007

- 4' hose and 1/4" female swivel nut
- Replaces Delta style thumb-controlled sink sprays and hoses

PART NO.	DESCRIPTION	CTN/MSTR
K55006	Spray assembly	1/50
K55007	Replacement hose only	1/50

Chrome Plated Soap And Lotion Dispenser



- All brass pump
- Large 7 oz. capacity bottle

PART NO.	DESCRIPTION	CTN/MSTR
S08020	Chrome plated dispenser	1/100

Sink Lugs

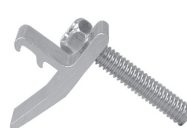

S58050

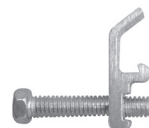

S58052



S58051

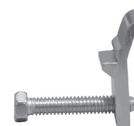

S58053

- Four lugs bagged with screws
- PRICED PER BAG

PART NO.	DESCRIPTION	CTN/MSTR
S58050	Combo clip for counters 5/8" - 1 1/8" thick	1/100
S58052	E-lug for counters 3/8" - 1/2" thick	1/100
S58051	Adjustable clips for counters 3/4" - 2 3/4" thick	1/100
S58053	KT lug with bolt	1/100

Undermount Sink Installation Kit



- Includes 4 each brackets, brass inserts, washers, bolts and wing nuts
- PRICED PER BAG

PART NO.	DESCRIPTION	CTN/MSTR
S58101	Undermount Kit	1/250

Lavatory Legs



- Fits vitreous china, steel or cast iron lavatories
- Sold in pairs

Total length ranges from 31 1/2" - 32 3/4" extended

PART NO.	DESCRIPTION	CTN/MSTR
L65001	27" legs	1/20

Lavatory And Sink Hangers



L56020



L56026



L56021



L56023



L56024

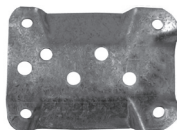

L56025

• Wall mount

PART NO.	DESCRIPTION	CTN/MSTR
L56020	Cast iron (for cast iron or vitreous china)	1/24
L56026	Pair cast iron hangers (for cast iron or vitreous china)	1/12
L56021	3-way steel (allows mounting in 3 directions)	1/24
L56023	Steel 10" centers (one piece)	1/100
L56024	7" stamped steel lavatory hanger	1/25
L56025	3-way steel lavatory bracket pair	1 pair/25

Adjustable Lavatory Hanger



- Durable cast iron
- Adjusts from 10 1/2" to 16"
- For iron, lugs fit into pockets
- For china, remove side lugs

PART NO.	DESCRIPTION	CTN/MSTR
L56027	Lav Hanger	1/25

Economy Replacement Basket Strainer



- ABS post
- Stainless steel basket

PART NO.	DESCRIPTION	CTN/MSTR
B03015	Replacement basket	1/200

Fit-All Basket Strainer



- Stainless steel

PART NO.	DESCRIPTION	CTN/MSTR
B03010	Fit-All strainer	1/200

Duo Basket Strainer



- 4 1/2" diameter to fit 3 1/2" drilling
- All stainless steel with zinc locknut
- Basket with rolled edge

PART NO.	DESCRIPTION	CTN/MSTR
S14001	SS duo strainer	1/50

Flat Top Grid Strainer



- 4 1/2" diameter to fit 3 1/2" drilling
- All stainless steel with zinc locknut (less tailpiece)

PART NO.	DESCRIPTION	CTN/MSTR
S14002	Flat grid strainer	1/24

Snap Lock Basket Strainer



- 4 1/2" diameter to fit 3 1/2" drilling
- All stainless steel
- Ball bearing basket with rolled edge (less tailpiece)

PART NO.	DESCRIPTION	CTN/MSTR
S14005	Snap lock basket strainer with zinc locknut	1/50
S14010	Snap lock basket strainer with brass locknut	1/50

Shallow Cup Duo Basket Strainer



- 4 1/2" diameter to fit 3 1/2" drilling
- All stainless steel with zinc locknut
- Basket with rolled edge (less tailpiece)

PART NO.	DESCRIPTION	CTN/MSTR
S14006	Shallow cup duo strainer	1/50

CP Brass Duo Strainer



PART NO.	DESCRIPTION	CTN/MSTR
S14007	CP brass duo strainer	1/25
S14011	Replacement strainer	1/25

Twist And Lock Basket Strainer



- 4 1/2" diameter to fit 3 1/2" drilling
- All stainless steel with zinc locknut
- Screw-in basket (less tailpiece)

PART NO.	DESCRIPTION	CTN/MSTR
S14003	Twist and lock basket strainer	1/50
S14103	Twist and lock replacement basket	1/50

Deep Cup Basket Strainer



- 4 1/2" diameter to fit 3 1/2" drilling
- All stainless steel with zinc locknut
- Basket with rolled edge (less tailpiece)

PART NO.	DESCRIPTION	CTN/MSTR
S14004	Deep cup basket strainer	1/50

Quick Fit Stainless Steel Basket Strainer



- Minimizes installation time
- Triangle frame mounts to underside
- Fits virtually all sinks
- Durable stainless construction with brass nut
- For replacement basket use B03015

PART NO.	DESCRIPTION	CTN/MSTR
S14008	Basket Strainer	1/50

Chrome Plated Brass Duo Basket Strainer



- Chrome plated brass body with stainless steel basket
- Heavy Duty construction
- Neoprene stopper

PART NO.	DESCRIPTION	CTN/MSTR
S14250	CP brass duo basket strainer	1/50

Stainless Steel Duo Basket Strainer



- SS body and basket
- Polished inner cup
- Chrome plated zinc post and slip nut
- Heavy duty rubber gasket and zinc locknut

PART NO.	DESCRIPTION	CTN/MSTR
S14251	SS duo post style basket strainer	1/50

Stainless Steel Deep Cup Basket Strainer



- Stainless steel body and locknut
- Neoprene stopper
- Spring style snap-in basket

PART NO.	DESCRIPTION	CTN/MSTR
S14014	SS cup basket strainer	1/50

Stainless Steel Duo Basket Strainer



- Stainless steel body and locknut
- Neoprene stopper
- Spring style snap-in basket

PART NO.	DESCRIPTION	CTN/MSTR
S14606	SS duo basket strainer	1/50

ABS Body And Post Basket Strainer



- Plastic nut

PART NO.	DESCRIPTION	CTN/MSTR
S14030	ABS body and post basket strainer	1/50

Deep Junior Duo Basket Strainer



B02102



B02103

- For 2" and 2 1/2" deep outlets and bar sinks

PART NO.	DESCRIPTION	CTN/MSTR
B02102	2" deep basket strainer	1/100
B02103	Replacement strainer	1/250

Junior Duo Basket Strainer



B02050



B02049

- Stainless steel body and basket with die cast locknut; 1 1/2" threads
- Complete with washers
- Fits 1 3/4" bar sink

PART NO.	DESCRIPTION	CTN/MSTR
B02050	Junior duo strainer	1/100
B02049	Replacement basket	1/500

Flat Duplex Strainer



PART NO.	DESCRIPTION	CTN/MSTR
B02052	Flat duplex strainer	1/100

- Stainless steel body and strainer with die cast locknut
- Complete with washers
- Fits 1 1/2" bar sink

Cast Brass Beehive Urinal Strainer



- Chrome plated brass strainer and body
- Brass locknut
- 2" caulk connection

PART NO.	DESCRIPTION	CTN/MSTR
D45000	Cast brass beehive urinal strainer	1/30
D45001	Replacement top with screws for D45000	1/100

Flexible Hair Strainer



- Soft rubber flexible strainer fits neatly over drain

PART NO.	DESCRIPTION	CTN/MSTR
P35180	Flexible hair strainer	1/1000

B

1" Brass Bar Plug



- Cast brass
- Includes ground seat plug

PART NO.	DESCRIPTION	CTN/MSTR
B02060	1" x 3"	1/50

Tray Plug



- Stainless steel body with die cast locknut
- Fits 1 1/2" bar sink
- Complete with washers and stoppers

PART NO.	DESCRIPTION	CTN/MSTR
B02051	Tray plug	1/100

In-Sink-Erator Rubber Hush Cushion



- Black

PART NO.	DESCRIPTION	CTN/MSTR
P35159	In-Sink-Erator	1/500

Kitchen Sink And Garbage Disposal Stopper



- Vinyl construction
- Flanged to fit all sizes

PART NO.	DESCRIPTION	CTN/MSTR
P35162	Sink stopper	1/50

Garbage Disposal Splash Guard



- Snap-fit reinforced ring
- Fits all disposal brands

PART NO.	DESCRIPTION	CTN/MSTR
P35163	Rubber fit-all	1/200

Three Prong Drain Protector



- Aluminum

PART NO.	DESCRIPTION	CTN QTY
D18062	1 5/8" drain protector	1/2500
D18063	1 7/8" drain protector	1/500

Sink And Basin Crumb Cups



- Nickel plated brass

PART NO.	DESCRIPTION	CTN/MSTR
P35165	1 1/2" crumb cup with post	1/500
P35166	1" crumb cup	1/1000
P35167	1 3/8" crumb cup	1/160

Slotted Full Flow Aerators



Male Thread



Female Thread



Dual Thread

- Chrome-plated brass
- Non-corrosive mixing chamber
- Individually bagged
- 4.5 gpm
- LEAD FREE

PART NO.	DESCRIPTION	CTN/MSTR
A01001	15/16"-27 male thread	25/600
A01002	55/64"-27 female thread	25/600
A01003	Dual threads (15/16"-27 male x 55/64"-27 female)	25/2000

Slotted 2.2 GPM Flow Aerators



- NSF listed santoprene washer
- Meets ANSI A-112.18M
- Easily cleaned
- Individually bagged
- LEAD FREE

PART NO.	DESCRIPTION	CTN/MSTR
A01004	Dual threads (15/16"-27 male x 55/64"-27 female)	25/600

Non-Slotted Full Flow Aerators



Male Thread



Female Thread



Dual Thread

- Individually bagged
- 4.5 GPM
- LEAD FREE

PART NO.	DESCRIPTION	CTN/MSTR
A01005	15/16"-27 male thread	25/600
A01006	55/64"-27 female thread	25/600
A01007	13/16"-27 male thread	25/600
A01008	3/4"-27 female thread	25/600
A01010	Dual threads (15/16"-27 male x 55/64"-27 female)	25/600

Non-Slotted .5 GPM Aerators



- Individually bagged
- LEAD FREE

PART NO.	DESCRIPTION	CTN/MSTR
A01037	Dual thread (15/16"-27 male x 55/64"-27 female	25/600

Non-Slotted Reduced Flow Aerators



Male Thread



Female Thread



Dual Thread

- Meets ANSI A-112.18M
- Individually bagged
- LEAD FREE

PART NO.	DESCRIPTION	CTN/MSTR
A01011	15/16"-27 male thread 2.2 gpm	25/600
A01012	55/64"-27 female thread 2.2 gpm	25/600
A01013	Dual threads 2.2 gpm (15/16"-27 male x 55/64"-27 female)	25/600
A01050	Dual threads 2.0 gpm (15/16"-27 male x 55/64"-27 female)	25/600
A01051	Dual threads 1.5 gpm (15/16"-27 male x 55/64"-27 female)	25/600

Chicago Style Faucet Aerator



- Individually bagged
- LEAD FREE

PART NO.	DESCRIPTION	CTN/MSTR
A01062	Non-slotted full flow (55/64"-27 female thread)	1/600

Aerator Counter Display



Display

- Dual threads are 15/16"-27 male x 55/64"-27 female
- 24 tubes per display box, six aerators per tube
- 144 pieces per display; priced per display
- LEAD FREE

PART NO.	DESCRIPTION	CTN/MSTR
A01015	Slotted full flow (A01003)	1/5
A01016	Slotted 2.2 gpm (A01004)	1/5
A01017	Non-slotted full flow (A01010)	1/5
A01018	Non-slotted 2.2 gpm (A01013)	1/5
A01060	Non-slotted 2.0 gpm (A01050)	1/5

Spring-Flo Faucet Aerator



- Dual thread
- Fully compliant with California AB1953 and Vermont S152
- LEAD FREE

PART NO.	DESCRIPTION	CTN QTY
A01900	Slotted 2.2 Spring-Flo	1
A01901	Slotted 2.2 Spring-Flo	Tube of 6/24

Aerator Six Pack Tubes For Counter Display



- Dual threads are 15/16"-27 male x 55/64"-27 female
- Six aerators per tube; priced per display
- LEAD FREE

Six Aerators per Tube

PART NO.	DESCRIPTION	CTN/MSTR
A01020	Slotted full flow (A01003)	Tube of 6/200
A01021	Slotted 2.2 gpm (A01004)	Tube of 6/200
A01022	Non-slotted full flow (A01010)	Tube of 6/200
A01023	Non-slotted 2.2 gpm (A01013)	Tube of 6/200
A01061	Non-slotted 2.0 gpm (A01050)	Tube of 6/200

Snap Fitting



A01029



A01036

- Aerated

PART NO.	DESCRIPTION	CTN/MSTR
A01029	Dual thread (15/16"-27 male x 55/64"-27 female x aerated snap fitting)	1/300
A01036	Nonplated brass snap coupler x 3/4" GHT for use with A01029 as a Quick-Disconnect unit	1/300

Swivel Spray Aerator



- Individually bagged
- Brass coupling nut
- Unit reverts to non-splash mode when water is turned off

PART NO.	DESCRIPTION	CTN/MSTR
A01014	Dual thread (15/16"-27 male x 55/64"-27 female))	12/72

Vandal-Proof Aerators



Male



Female

- Special key wrench included
- Prevents unauthorized removal

PART NO.	DESCRIPTION	CTN QTY
A01024	15/16"-27 male full flow	1/600
A01026	15/16"-27 male 2.0 gpm	1/600
A01027	55/64"-27 female 2.0 gpm	1/25

Faucet Adapters

B



A01030



A01032



A01033



A01035

• These parts are not OEM

To Fit Delta*, American Standard* Style

PART NO.	DESCRIPTION	CTN/MSTR
A01030	CP brass 15/16"-27 male x 55/64"-27 male threads	1/25
A01031	Plastic 15/16"-27 male x 55/64"-27 male threads	1/300

To Fit Price Pfister, Kohler* Style

PART NO.	DESCRIPTION	CTN/MSTR
A01032	CP brass female 3/4"-27 x 55/64"-27 male threads	1/300

To Fit Kohler*, Union*, Savoy* Style

PART NO.	DESCRIPTION	CTN/MSTR
A01033	CP brass male 13/16"-27 x 55/64"-27 male threads	1/300
A01034	Plastic male 13/16"-27 x 55/64"-27 male threads	1/500

To Fit Chicago* Style

PART NO.	DESCRIPTION	CTN/MSTR
A01035	CP brass female 13/16"-24 x 55/64"-27 male threads	1/500

Faucet To Garden Hose Adapters



• Chrome plated brass
• Lead Free

PART NO.	DESCRIPTION	CTN/MSTR
A01040	Dual threads 15/16"-27 male x 55/64"-27 female x 3/4" MGH	1/600
A01041	Dual threads 15/16"-27 male x 55/64"-27 female x 3/4" MGH and 55/64"-27 male	1/600

* The manufacturers' names are used only to describe whose products the replacement handles will fit. The products are not manufactured by those companies.

Fit All Replacement Handles



Cross Pattern



Lever Pattern



Acrylic

• Vise grip design allows units to fit all types of stems, including rounded
• Each pair individually bagged

PART NO.	DESCRIPTION	CTN/MSTR
H54001	Cross pattern	5/100
H54002	Lever pattern	5/100
H54003	Acrylic	5/100

Delta*/Peerless* Replacement Handles



H54010



H54011



H54012

• New design
• Includes button and screw

PART NO.	DESCRIPTION	CTN/MSTR
H54010	Single layer crystal handle for all lav faucets using 212* ball	1/5
H54011	Single layer crystal handle offset broach for tub and shower valves using 212* ball	1/5
H54012	Single layer crystal tub handle for Scald Guard*	1/5

Delex*/Peerless* Replacement Handles



H54013



H54014

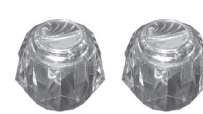

H54015

• Includes button and screws

PART NO.	DESCRIPTION	CTN/MSTR
H54013	Two chrome plated canopy handles for center set	1/5
H54014	Two crystal handles for center set new style	1/5
H54015	Two crystal handles for wide spread lav and tub and shower valves	1/5

Mixet* Replacement Handles



H54017



H54018

• Includes screw

PART NO.	DESCRIPTION	CTN/MSTR
H54017	Clear outer handle (MRH-CLR*)	1/5
H54018	Clear inner handle (MTH-CLR*)	1/5

* The manufacturers' names are used only to describe whose products the replacement handles will fit. The products are not manufactured by those companies.

Valley*/Aqualine*/Eljer*/Sears* Replacement Handles



• New style crystal handle
• Complete with button and screw

PART NO.	DESCRIPTION	CTN/MSTR
H54030	Crystal single handle	1/5

Moen®/Stanadyne® Replacement Handles



H54025



H54026



H54027



H54028



H54029

- Complete with button and screw
- Teardrop® replaces both round and Teardrop® handles

PART NO.	DESCRIPTION	CTN/MSTR
H54025	Crystal Teardrop® single lav handle shallow broach	1/5
H54026	Crystal Teardrop® single tub handle deep broach	1/5
H54027	Round crystal single lav handle shallow broach	1/5
H54028	Round crystal single tub handle deep broach	1/5
H54029	Chrome plated cap and cover for single handle kitchen faucet	1/5

Delta®/Peerless® Faucet Index Buttons



H54040



H54041

- Single handle models

PART NO.	DESCRIPTION	CTN/MSTR
H54040	Old style crystal button for lav and tub and shower valve 1" OD	5/35
H54041	New large style crystal button for lav and tub and shower valve 1 1/2" OD	5/35

Moen®/Stanadyne® Single Handle Replacement Buttons



H54060



H54061

PART NO.	DESCRIPTION	CTN/MSTR
H54060	Button for new style Teardrop® crystal handle	1/5
H54061	Button for round crystal handle lav and tub and shower valve	1/5

* The manufacturers' names are used only to describe whose products the replacement handles will fit. The products are not manufactured by those companies.

Sure Grip Escutcheons



Low Pattern



Box Pattern



Bell Pattern

- Chrome plated steel
- CARTON QUANTITIES ONLY

Low-Pattern- Copper Tube Size			
PART NO.	SIZE	FLANGE OD	CTN QTY
E01375	3/8" (1/2" OD)	2 1/2"	25/2000
E01050	1/2" (5/8" OD)	2 1/2"	25/2000
E01075	3/4" (7/8" OD)	2 1/2"	252000
E01100	1" (1 1/8" OD)	2 7/8"	25/2000
E01125	1 1/4" (1 3/8" OD)	2 7/8"	25/1200
E01150	1 1/2" (1 5/8" OD)	2 7/8"	25/1200

Low-Pattern- Iron Pipe Size			
PART NO.	SIZE	FLANGE OD	CTN QTY
E02375	3/8"	2 1/2"	25/2000
E02050	1/2"	2 1/2"	25/2000
E02075	3/4"	2 1/2"	25/2000
E02100	1"	2 7/8"	25/1000
E02125	1 1/4"	2 7/8"	25/1200
E02150	1 1/2"	3"	25/1200
E02152	1 1/2"	3 1/2"	25/1200
E02200	2"	3 1/2"	25/1200

Low Pattern- Tubular			
PART NO.	SIZE	FLANGE OD	CTN QTY
E03125	1 1/4"	2 7/8"	25/1200
E03150	1 1/2"	2 7/8"	25/1200
E03200	2"	3 1/2"	25/1200

Box Pattern- Tubular			
PART NO.	SIZE	FLANGE OD	CTN QTY
E04125	1 1/4"	3"	5/300
E04150	1 1/2"	3"	5/300
E04200	2"	3"	5/300

Box Pattern- Iron Pipe Size			
PART NO.	SIZE	FLANGE OD	CTN QTY
E05125	1 1/4"	3"	5/300
E05150	1 1/2"	3"	5/300

Bell Pattern- Iron Pipe Size			
PART NO.	SIZE	FLANGE OD	CTN QTY
E06375	3/8"	2 3/8"	25/1000
E06050	1/2"	2 3/8"	25/1000
E06075	3/4"	2 3/8"	25/1000
E06100	1"	3"	25/1000
E06125	1 1/4"	3"	25/1000
E06150	1 1/2"	3"	25/1000

Bell Pattern- Copper Tube Size			
PART NO.	SIZE	FLANGE OD	CTN QTY
E07025	1/4" (3/8" OD)	2 3/8"	25/1000
E07375	3/8" (1/2" OD)	2 3/8"	25/1000
E07050	1/2" (5/8" OD)	2 3/8"	25/1000

Bell Pattern- Tubular			
PART NO.	SIZE	FLANGE OD	CTN QTY
E08125	1 1/4" OD	3"	25/1000
E08138	1 3/8" OD	3"	25/1000
E08150	1 1/2" OD	3"	25/1000

Plastic Shallow Flange Escutcheons



- Tight fit
- Low cost
- Corrosion-proof, indestructible, high-density polyethylene
- CARTON QUANTITIES ONLY

B

Copper Tube Size

PART NO.	SIZE	COLOR	CTN QTY
E15375	1/2" OD (3/8" CTS)	White	50 per bag
E15050	5/8" OD (1/2" CTS)	White	50 per bag
E15052	5/8" OD (1/2" CTS)	Almond	50 per bag
E15075	7/8" OD (3/4" CTS)	White	50 per bag

Iron Pipe Size

PART NO.	SIZE	COLOR	CTN QTY
E16375	3/8" IPS	White	50 per bag
E16050	1/2" IPS	White	50 per bag
E16075	3/4" IPS	White	50 per bag
E16150	1 1/2" IPS	White	50 per bag
E16151	1 1/2" IPS	Almond	50 per bag
E16200	2" IPS	White	50 per bag

Tubular

PART NO.	SIZE	COLOR	CTN QTY
E03225	1 1/4" Tubular	White	50 per bag
E03250	1 1/2" Tubular	White	50 per bag

Poly Bagged Escutcheons



- 50 per bag
- Chrome plated steel
- CARTON QUANTITIES ONLY

PART NO.	DESCRIPTION	CTN/MSTR
E01049	1/2" CTS (5/8" O.D.)	50/2000
E01074	3/4" CTS (7/8" O.D.)	50/2000

Floor & Ceiling Plates



- Chrome plated
- CARTON QUANTITIES ONLY

Light Gauge- Copper Tube Size

PART NO.	SIZE	FLANGE OD	CTN QTY
F01375	3/8" (1/2" OD)	2 1/2"	12/576
F01050	1/2" (5/8" OD)	2 5/8"	12/576
F01075	3/4" (7/8" OD)	2 27/32"	12/576
F01100	1" (1 1/8" OD)	3 9/32"	12/576
F01125	1 1/4" (1 3/8" OD)	3 5/8"	12/576
F01150	1 1/2" (1 5/8" OD)	3 15/16"	12/576

Light Gauge- Iron Pipe Size

PART NO.	SIZE	FLANGE OD	CTN QTY
F02375	3/8"	2 1/2"	12/576
F02050	1/2"	2 5/8"	12/576
F02075	3/4"	2 27/32"	12/576
F02100	1"	3 9/32"	12/576
F02125	1 1/4"	3 5/8"	12/576
F02150	1 1/2"	3 15/16"	12/576
F02200	2"	4 3/8"	12/576

Heavy Gauge With Springs- Copper Tube Size

PART NO.	SIZE	FLANGE OD	CTN QTY
F03375	3/8" (1/2" OD)	2 1/8"	12/480
F03050	1/2" (5/8" OD)	2 7/16"	12/480
F03075	3/4" (7/8" OD)	2 21/32"	12/480
F03100	1" (1 1/8" OD)	2 27/32"	12/480
F03125	1 1/4" (1 3/8" OD)	3 9/32"	12/240
F03150	1 1/2" (1 5/8" OD)	3 5/8"	12/240
F03200	2" (2 1/8" OD)	4 3/16"	12/240
F03250	2 1/2" (2 5/8" OD)	4 15/16"	6/240
F03300	3" (3 1/8" OD)	5 3/16"	6/240

Heavy Gauge With Springs- Iron Pipe Size

PART NO.	SIZE	FLANGE OD	CTN QTY
F04375	3/8"	2 1/2"	12/480
F04050	1/2"	2 5/8"	12/480
F04075	3/4"	2 27/32"	12/480
F04100	1"	3 9/32"	12/480
F04125	1 1/4"	3 5/8"	12/240
F04150	1 1/2"	3 15/16"	12/240
F04200	2"	4 3/8"	12/240
F04250	2 1/2"	5 7/32"	6/120
F04300	3"	5 29/32"	6/120
F04350	3 1/2"	6 9/16"	6/120
F04400	4"	7 3/16"	6/120
F04500	5"	8 7/8"	1/60
F04600	6"	10"	1/60
F04800	8"	13"	1/48
F04999	10"	15"	1/48

Flexible Floor & Ceiling Plates



- Chrome plated
- CARTON QUANTITIES ONLY

Chrome Plated Plastic

PART NO.	IPS	CTS	FLANGE OD	CTN/MSTR
F06375	3/8"	1/2"	2.572	12/1080
F06050	1/2"	3/4"	2.787	12/1080
F06075	3/4"	-	2.997	12/1440
F06099	-	1"	3.077	12/1440
F06100	1"	-	3.210	12/1440
F06124	-	1 1/4"	3.308	12/1440
F06125	1 1/4"	1 1/2"	3.580	12/1200
F06150	1 1/2"	-	3.900	12/1200
F06200	2"	-	4.450	12/720
F06201	-	2"	4.205	12/720
F06250	2 1/2"	-	5.313	12/600
F06251	-	2 1/2"	4.688	12/600
F06300	3"	-	5.875	12/480
F06301	-	3"	5.375	12/240
F06351	-	3 1/2"	5.875	12/240
F06400	4"	-	6.781	12/240
F06401	-	4"	6.344	12/240
F06500	5"	-	8.531	6/240
F06600	6"	-	9.688	6/120
F06800	8"	-	13.000	6/96

White Plastic

PART NO.	IPS	CTS	FLANGE OD	CTN/MSTR
F07375	3/8"	1/2"	2.572	12/1080
F07050	1/2"	3/4"	2.787	12/1080
F07075	3/4"	-	2.997	12/1440
F07099	-	1"	3.077	12/1080
F07100	1"	-	3.210	12/1440
F07124	-	1 1/4"	3.308	12/1440
F07125	1 1/4"	1 1/2"	3.580	12/1200
F07150	1 1/2"	-	3.900	12/1200
F07200	2"	-	4.450	12/720
F07201	-	2"	4.205	12/720
F07300	3"	-	5.825	12/480

Sewer Popper™ Cleanout And Relief Valve

- Automatic pop-up releases sewage overflow outside the house
- Prevents thousands of dollars in property damages
- Eliminates health hazards associated with sewage overflow
- Vandal- and tamper-resistant center
- Threaded for 3" or 4" pipe or tapped together
- Constructed of white PVC
- Threaded unit can be used with PVC or ABS tapped together
- For cast iron pipe, use standard no hub clamp
- Meets Southern Building Code Section 301.10, Principle No.10
- Patent No. 5,209,257



B

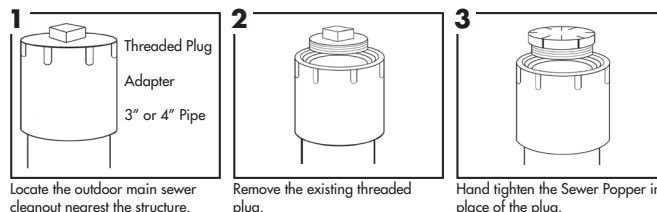

PART NO.	DESCRIPTION	CTN/MSTR
S62304	3"x 4" Sewer Popper™	1/6

Sewer Relief Valve And Cleanout

- Releases waste to outside of buildings in the event of sewer line blockage, preventing costly damage due to sewage backflow or overflow.
- Applicable in residential, commercial, or industrial settings- any structure connected to sewer lines or septic tanks
- Patent #4,475,571
- Meets ASTM specifications
- Automatic unlock and re-lock
- Vandal-resistant
- Safe in yard or high traffic areas
- Solvent welds over 4" Schedule 40 DWV pipe
- Removable lid provides full access to cleanout
- May be used to replace existing exterior cleanouts
- Easily adaptable to new or existing sewer lines
- Water and waste swirl in bowl until blockage is cleared

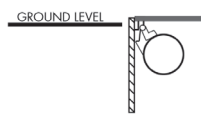

Locked in Normal Position

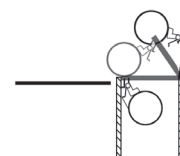

Opens When Overflow Occurs

PART NO.	DESCRIPTION	CTN QTY
S62100	PVC sewer relief valve	1
S62101	ABS sewer relief valve	1

Sewer Stopper/ Backflow Preventer



- Use inside drain line to help guard against backups
- Creates seal in pipe to reduce sewer gases
- Secures into place with set screws
- Compression fit

PART NO.	DESCRIPTION	CTN/MSTR
S63200	2" sewer stopper (ZP steel)	1/100
S63300	3" sewer stopper (brass)	1/80
S63400	4" sewer stopper (brass)	1/60

Cover Plates

- Mirrored acrylic
- Conceals damaged/cracked tiles
- Fits all standard bath/shower fittings
- No tools required- use silicone caulk
- DO NOT use abrasive cleaners

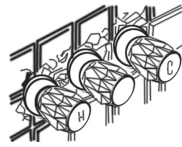

B

T73001

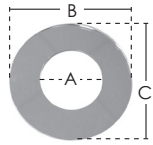

A	B	C	THICKNESS
1 11/16"	3 1/2"	3 1/2"	1/8"

T73002

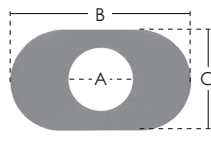

A	B	C	THICKNESS
5"	14"	8"	1/8"

T73003

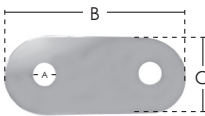

A	B	C	THICKNESS
1 3/4"	14"	6"	1/8"

T73004

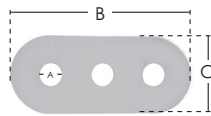

A	B	C	THICKNESS
1 3/4"	14"	6"	1/8"

PART NO.	DESCRIPTION	SIZE	CTN/MSTR
T73001	Tub spout model	3 1/2" diameter	1/300
T73002	One handle model	8" x 14"	1/100
T73003	Two handle model	6" x 14"	1/40
T73004	Three handle model	6" x 14"	1/36

Stainless Steel Repair Cover Plates



- 1, 2 or 3 hole design to fit multitude of valves
- Polished stainless steel finish
- Easily attaches with silicone caulk; one hole has brackets and screw
- 7 1/4" x 13" long

PART NO.	# OF HOLES	DIAMETER	CTN/MSTR
T73815	1	5 1/8"	1/40
T73816	2	1 3/8"	1/40
T73817	3	1 3/8"	1/40
T73818	1	3 3/4"	1/40

Flexible Stainless-Steel Plumbing Connectors



- Reliable, trouble-free service- Inner core of non-toxic polymer withstands temperatures of 33°F (1°C) to 174°F (99°C)
- Leak proof seal- High quality outer braid of stainless steel and exclusive crimp-on fittings for maximum performance
- Quick and easy installation- No special tools; no soldering
- No pipe bending- Flexible connectors simplify installation- even in cramped spaces
- Chrome plated nut
- These products are NSF approved
- LEAD FREE

Faucet

PART NO.	OD x FIP	LENGTH	CTN/MSTR
S04200	3/8" x 1/2"	9	25/100
S04201	3/8" x 1/2"	12	25/100
S04202	3/8" x 1/2"	16	25/100
S04203	3/8" x 1/2"	20	25/100
S04204	3/8" x 1/2"	30	25/50
S04205	3/8" x 1/2"	36	25/100
S04206	1/2" x 1/2"	12	25/100
S04207	1/2" x 1/2"	16	25/100
S04208	1/2" x 1/2"	20	25/100
S04209	1/2" x 1/2"	30	25/50
S04210	1/2" x 1/2"	36	25/100

Faucet

PART NO.	FIP x FIP	LENGTH	CTN/MSTR
S04211	1/2" x 1/2"	12	25/100
S04212	1/2" x 1/2"	16	25/175
S04213	1/2" x 1/2"	20	25/100
S04214	1/2" x 1/2"	30	25/50
S04215	1/2" x 1/2"	36	25/50

Flexible Stainless-Steel Plumbing Connectors



- Reliable, trouble-free service- Inner core of non-toxic polymer withstands temperatures of 33°F (1°C) to 174°F (99°C)
- Leak proof seal- High quality outer braid of stainless steel and exclusive crimp-on fittings for maximum performance
- Quick and easy installation- No special tools; no soldering
- No pipe bending- Flexible connectors simplify installation- even in cramped spaces
- LEAD FREE

Ballcock

PART NO.	OD x BC	LENGTH	CTN QTY
S04216	3/8" x 7/8"	9	25/100
S04217	3/8" x 7/8"	12	25/100
S04218	3/8" x 7/8"	16	25/100
S04219	3/8" x 7/8"	20	25/100
S04220	1/2" x 7/8"	9	25/100
S04221	1/2" x 7/8"	12	25/100
S04222	1/2" x 7/8"	16	25/100
S04223	1/2" x 7/8"	20	25/100
S04255	3/8" x 7/8" w/ brass nut	12	25/100

Ballcock

PART NO.	FIP x BC	LENGTH	CTN QTY
S04224	1/2" x 7/8"	9	25/100
S04225	1/2" x 7/8"	12	25/100
S04226	1/2" x 7/8"	20	25/100

Ballcock

PART NO.	FLARE x BC	LENGTH	CTN QTY
S04280	1/2" x 7/8"	20	25/100
S04285	3/8" x 7/8"	20	25/50

Washing Machine

PART NO.	FEM HOSE x FEM HOSE	LENGTH	CTN QTY
S04227	3/4" x 3/4"	48	5/50
S04228	3/4" x 3/4"	60	5/175
S04229	3/4" x 3/4"	72	5/50

Icemaker

PART NO.	OD x OD	LENGTH	CTN QTY
S04230	1/4" x 1/4"	12	5/50
S04231	1/4" x 1/4"	60	5/50
S04232	1/4" x 1/4"	84	5/50

B

Flexible Stainless-Steel Plumbing Connectors

B



- Reliable, trouble-free service- Inner core of non-toxic polymer withstands temperatures of 33°F (1°C) to 174°F (81°C); burst pressure 1,000 PSI
- Leak proof seal- High quality outer braid of stainless steel and exclusive crimp-on fittings for maximum performance
- Quick and easy installation- No special tools; no soldering
- No pipe bending- Flexible connectors simplify installation- even in cramped spaces
- Chrome plated nut
- These products are NSF approved
- LEAD FREE

Dishwasher Connectors

90° Elbow

PART NO.	OD x MIP	LENGTH	CTN/MSTR
S04233	3/8" x 3/8"	48	25/50
S04234	3/8" x 3/8"	60	25/50
S04235	3/8" x 3/8"	72	25/50
S04236	1/2" x 3/8"	48	25/50
S04237	1/2" x 3/8"	60	25/50
S04238*	1/2" x 3/8"	72	25/50

*elbow not included

Dishwasher Connectors

PART NO.	OD x OD	LENGTH	CTN/MSTR
S04260	3/8" x 3/8"	48	25/50
S04268	3/8" x 3/8"	12	25/100
S04269	3/8" x 3/8"	16	25/100
S04270	3/8" x 3/8"	20	25/100

SS "Delta" Style Faucet Connectors

*Complies with NSF 61

PART NO.	OD x COMP FITTING	LENGTH	CTN/MSTR
S04239	3/8" x 3/8"	9	25/100
S04240	3/8" x 3/8"	12	25/100
S04241	3/8" x 3/8"	16	25/100
S04242	3/8" x 3/8"	20	25/100
S04243	3/8" x 3/8"	30	25/50
S04244	3/8" x 3/8"	36	25/100

Texas Style Faucet Connectors

*Complies with NSF 61

PART NO.	FL x OD	LENGTH	CTN/MSTR
S04245	3/8" x 3/8"	9	25/100
S04246	3/8" x 3/8"	12	25/100
S04247	3/8" x 3/8"	16	25/100
S04248	3/8" x 3/8"	20	25/100
S04249	3/8" x 3/8"	30	25/50
S04250	3/8" x 3/8"	36	25/100

Stainless Steel Dishwasher Connection w/Garden Hose Fitting & 90



- Use to connect Whirlpool, Maytag, Amana, Kitchen Aid and Jenn-Air dishwashers manufactured after September 2009

PART NO.	DESCRIPTION	CTN QTY
S04275	3/8" OD x 3/8" MIP x 60"	1
S04276	3/8" OD x 3/8" MIP x 72"	1
G20086	Garden Hose Ftg & 90 only - 3/4" FGHT x 3/8" OD Comp	1

Braided Nylon Plumbing Connectors



- Reliable, economy style connectors
- Temperature rated 173° (82°C)
- Burst pressure is 450 PSI
- Chrome plated nut
- These products are UPC approved
- LEAD FREE

Nylon Faucet Connectors

PART NO.	OD x FIP	LENGTH	CTN/MSTR
S04400	3/8" x 1/2"	9	25/100
S04401	3/8" x 1/2"	12	25/100
S04402	3/8" x 1/2"	16	25/100
S04403	3/8" x 1/2"	20	25/100
S04404	3/8" x 1/2"	30	25/50
S04405	1/2" x 1/2"	12	25/100
S04406	1/2" x 1/2"	16	25/100
S04407	1/2" x 1/2"	20	25/150
S04408	1/2" x 1/2"	30	25/100

Nylon Faucet Connectors

PART NO.	FIP x FIP	LENGTH	CTN/MSTR
S04409	1/2" x 1/2"	12	25/100
S04410	1/2" x 1/2"	16	25/100
S04411	1/2" x 1/2"	20	25/100
S04440	1/2" x 1/2"	36	25/100

Nylon Faucet Connectors

PART NO.	COMP x FIP	LENGTH	CTN/MSTR
S04450	3/8" x 1/2"	24	25/100
S04455	3/8" x 1/2"	36	25/50

Nylon Delta Connectors

PART NO.	OD x COMP FITTING	LENGTH	CTN/MSTR
S04412	3/8" x 3/8"	12	25/100
S04413	3/8" x 3/8"	20	25/100

Nylon Toilet Connectors

PART NO.	OD x BC	LENGTH	CTN/MSTR
S04414	3/8" x 7/8"	9	25/100
S04415	3/8" x 7/8"	12	25/100
S04416	3/8" x 7/8"	16	25/100
S04417	3/8" x 7/8"	20	25/100
S04418	1/2" x 7/8"	9	25/100
S04419	1/2" x 7/8"	12	25/200
S04420	1/2" x 7/8"	16	25/100
S04421	1/2" x 7/8"	20	25/100

Nylon Toilet Connectors

PART NO.	FIP x BC	LENGTH	CTN/MSTR
S04422	1/2" x 7/8"	9	25/100
S04423	1/2" x 7/8"	12	25/100
S04424	1/2" x 7/8"	20	25/100

Nylon Dishwasher Connectors

90° Elbow

PART NO.	OD x MIP	LENGTH	CTN/MSTR
S04430	3/8" x 3/8"	72	25/50

"PEX" Supply Tubes (3/8" OD)



- NSF listed material
- Rated 100 psi at 180°F
- Resistant to corrosion and damage due to freezing
- Use with standard compression stops or valves

Basin Supply Tubes

PART NO.	DESCRIPTION	CTN/MSTR
S04101	3/8" x 12"	10/325
S04102	3/8" x 15"	10/250
S04103	3/8" x 20"	10/150
S04104	3/8" x 30"	10/200
S04108	3/8" x 36"	10/200

Tank Supply Tubes

PART NO.	DESCRIPTION	CTN/MSTR
S04105	3/8" x 12"	10/300
S04106	3/8" x 15"	10/250
S04107	3/8" x 20"	10/175

PEX Supply Tube With Ferrule



- NSF listed material
- Supplied with ferrule
- Rated 100 PSI at 180°

PART NO.	DESCRIPTION	CTN/MSTR
S04121	3/8" x 12 Basin	10/100
S04123	3/8" x 20 Basin	10/100
S04124	3/8" x 30 Basin	10/100
S04128	3/8" x 36 Basin	10/100
S04125	3/8" x 12 Tank	10/100
S04127	3/8" x 20 Tank	10/100

Chrome Plated Flexible Basin Supply Tube



- Lead Free

PART NO.	DESCRIPTION	CTN/MSTR
S04020	3/8" x 12"	1/500
S04021	3/8" x 16"	1/400
S04022	3/8" x 20"	1/300
S04023	3/8" x 30"	1/200
S04024	3/8" x 36"	1/200
S04025	1/2" x 12"	1/200
S04026	1/2" x 20"	1/200

Chrome Plated Flexible Tank Supply Tube



- Lead Free

PART NO.	DESCRIPTION	CTN/MSTR
S04027	3/8" x 12"	1/500
S04028	3/8" x 16"	1/300
S04029	3/8" x 20"	1/300
S04030	1/2" x 12"	1/50

Flexible Basin Supply Tube



- Lead Free
- Chrome plated
- With rubber nose cone

PART NO.	DESCRIPTION	CTN/MSTR
S04031	3/8" x 12"	1/100
S04032	3/8" x 20"	1/100

B

Supply Stop-180° Turn

B



• UPC listed

PART NO.	DESCRIPTION	CTN QTY
S10200	3/8 FIP x OD Angle	1/200
S10201	3/8 FIP x 3/8 OD Straight	1/200
S10202	1/2 FIP x 1/4 OD Angle	1/200
S10203	1/2 FIP x 3/8 OD Angle	1/200
S10204	1/2 FIP x 7/16 OD Angle	1/200
S10205	1/2 FIP x 1/2 OD Angle	1/200
S10206	1/2 FIP x 3/8 OD Straight	1/200
S10207	1/2 FIP x 1/2 OD Straight	1/200
S10208	3/8 OD x 3/8 OD Straight	1/200
S10209	5/8 OD x 1/4 OD Angle	1/200
S10210	5/8 OD x 3/8 OD Angle	1/200
S10211	5/8 OD x 3/8 OD Crse Thread Angle	1/200
S10212	5/8 OD x 7/16 OD Angle	1/200
S10213	5/8 OD x 1/2 OD Angle	1/200
S10214	5/8 OD x 3/8 OD Straight	1/200
S10215	5/8 OD x 1/2 OD Straight	1/200
S10216	1/2 Sweat x 3/8 OD Angle	1/200
S10217	1/2 Sweat x 1/2 OD Angle	1/200
S10218	1/2 Sweat x 3/8 OD Straight	1/200
S10219	1/2 Sweat x 1/2 OD Straight	1/200
S10220	1/2 FIP x 3/8 OD Dual	1/200
S10221	1/2 FIP x 7/16 OD x 7/16 OD Dual	1/200
S10222	1/2 FIP x 7/16 OD x 1/2 OD Dual	1/200
S10223	1/2 FIP x 1/2 OD x 3/8 OD Dual	1/200
S10224	1/2 FIP x 1/2 OD x 1/2 OD Dual	1/200
S10260	1/2 PEX x 1/4 OD Angle	1/200
S10261	1/2 PEX x 3/8 OD Angle	1/200
S10262	3/8 PEX x 3/8 OD Angle	1/200
S10267	1/2 PEX x 3/8 OD Straight	1/200
S10275	1/2 CPVC x 3/8 OD Straight	1/200
S10280	1/2 CPVC x 3/8 OD Angle	1/200

LEAD FREE

PART NO.	DESCRIPTION	CTN QTY
S10300	1/2 FIP x 3/8 OD Angle	1/200
S10301	5/8 OD x 3/8 OD Angle	1/200
S10302	1/2 FIP x 3/8 OD Straight	1/200
S10303	5/8 OD x 5/8 OD Straight	1/200
S10316	5/8 OD x 1/2 OD Straight	1/200
S10318	1/2 PEX x 3/8 OD Angle	1/200
S10319	1/2 CPVC x 3/8 COMP Straight	1/200
S10320	1/2 CPVC x 3/8 COMP Angle	1/200

Supply Stop-1/4 Turn

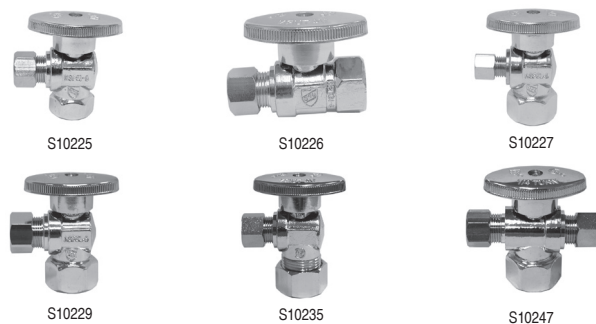

• UPC listed

PART NO.	DESCRIPTION	CTN QTY
S10225	3/8 FIP x 3/8 OD Angle	1/200
S10226	3/8 FIP x 3/8 OD Straight	1/200
S10227	1/2 FIP x 1/4 OD Angle	1/200
S10228	1/2 FIP x 3/8 OD Angle	1/200
S10229	1/2 FIP x 7/16 OD Angle	1/200
S10230	1/2 FIP x 1/2 OD Angle	1/200
S10231	1/2 FIP x 3/8 OD Straight	1/200
S10232	1/2 FIP x 1/2 OD Straight	1/200
S10233	3/8 OD x 3/8 OD Straight	1/200
S10234	5/8 OD x 1/4 OD Angle	1/200
S10235	5/8 OD x 3/8 OD Angle	1/200
S10236	5/8 OD x Crse Thrd x 3/8 OD Angle	1/200
S10237	5/8 OD x 7/16 OD Angle	1/200
S10238	5/8 OD x 1/2 OD Angle	1/200
S10239	5/8 OD x 3/8 OD Straight	1/200
S10240	5/8 OD x 1/2 OD Straight	1/200
S10241	1/2 Sweat x 3/8 OD Angle	1/200
S10242	1/2 Sweat x 1/2 OD Angle	1/200
S10243	1/2 Sweat x 3/8 OD Straight	1/200
S10244	1/2 Sweat x 1/2 OD Straight	1/200
S10247	1/2 FIP x 3/8 OD x 3/8 OD Dual	1/200
S10248	1/2 FIP x 7/16 OD x 7/16 OD Dual	1/200
S10249	1/2 FIP x 7/16 OD x 1/2 Dual	1/200
S10250	1/2 FIP x 1/2 OD x 3/8 OD Dual	1/200
S10251	1/2 FIP x 1/2 OD x 1/2 OD Dual	1/200
S10252	5/8 OD x 3/8 OD x 3/8 OD Dual	1/200
S10253	5/8 OD x 3/8 OD x 1/4 OD Dual	1/200
S10263	1/2 PEX x 1/4 OD Angle	1/150
S10264	1/2 PEX x 3/8 OD Angle	1/144
S10265	3/8 PEX x 3/8 OD Angle	1/150
S10266	1/2 PEX x 3/8 OD Straight	1/144

LEAD FREE

PART NO.	DESCRIPTION	CTN QTY
S10310	1/2 FIP x 3/8 OD Angle	1/200
S10311	5/8 OD x 3/8 OD Angle	1/200
S10312	1/2 FIP x 3/8 OD Straight	1/200
S10313	5/8 OD x 3/8 OD Straight	1/200
S10314	1/2 PEX x 3/8 OD Angle	1/200
S10315	1/2 PEX x 3/8 OD Straight	1/200
S10317	5/8 OD x 1/4 OD Angle	1/200

Drinking Fountain Bubbler and Cartridge



- 3/8" FIP connection
- Stainless steel cartridge
- Chrome plated brass body
- LEAD FREE- meets NSF standard 61.9

PART NO.	DESCRIPTION	CTN/MSTR
B45215	CP Brass bubbler with stainless steel cartridge	1/40
B45216	Replacement cartridge	100/500

Drinking Fountain Bubbler With Face Guard



Flexible Water Shield

- LEAD FREE- Meets NSF 61.9
- Chrome plated brass body
- Equipped with unique neo-poly water shield to prevent injuries to teeth, gums and face
- Tamper proof design requires 5/16" hex key to remove/ replace water shield for cleaning
- B45218 Kit includes new water shield, washer, and retainer nut

PART NO.	DESCRIPTION	CTN/MSTR
B45216	Replacement cartridge	100/500
B45217	Bubbler	1/40
B45218	Polymer Water Shield Kit	1/120

Self-Closing Drinking Fountain



- Mildew resistant
- Perfect for schools
- Chrome plated brass
- Stainless steel cartridge
- 1/2" Female pipe threads
- LEAD FREE

PART NO.	DESCRIPTION	CTN/MSTR
B45200	Drinking Fountain	1/25

Retrofit Bubbler Kit



- Replaces fountain on china fixtures
- Contains bubbler 1/2" x 3/8" x 3 1/2" nipple, rosette flange, locknut, coupling nut and 1 3/4" faucet cover

PART NO.	DESCRIPTION	CTN/MSTR
B45220	Drinking Fountain	1/20

Cross Handle Self Closing Valve



- Heavy brass construction
- Chrome plated

PART NO.	DESCRIPTION	CTN/MSTR
S05105	1/2" FIP	25/50

Single Kitchen Sink Faucet



- Chrome plated bodies and tee handles
- Replaceable washers

PART NO.	INLET	FLANGE	CTN/MSTR
S08003	1/2" FIP	Fixed (3/4" hose outlet)	12/72

Wall Mount Sink Faucet



- 8" center to center
- Adjustable 1/2" female threaded eccentric couplings
- Replaceable seats and stems
- Chrome plated with soap dish mounted on body
- Meets NSF standard 61.9
- Lead Free

PART NO.	DESCRIPTION	CTN/MSTR
S08008	8" tubular spout	1/20
S08012	12" tubular spout	1/20
S08030	Hot repair kit (handle, stem and seat)	1/100
S08031	Cold repair kit (handle, stem and seat)	1/100
S08032	Union repair kit (union assembly)	1/50

LEAD FREE

PART NO.	DESCRIPTION	CTN/MSTR
S08018	8" tubular spout	1/20

Laundry Tray Faucets



A01006

- Supplied with garden hose adapter and A01006 aerator
- Can be used either way with either adapter or aerator
- Meets Detroit Code

PART NO.	DESCRIPTION	CTN/MSTR
L47001	Chrome	1/24
L47004	With Gooseneck spout	1/24

Basin Faucet



Heavy Pattern



Standard Pattern

- Chrome plated
- Replaceable seats and stems
- Furnished with hot and cold buttons
- Meets NSF standard 61.9
- Lead Free

PART NO.	DESCRIPTION	CTN/MSTR
F39001	Heavy pattern with aerator - LEAD FREE	1/30
F39002	Standard pattern - LEAD FREE	1/50
F39004	Repair kit for 002 series (Handle, seat, stem and buttons)	1/100
F39005	Repair kit for 001 series (Handles, seat, stem and buttons)	1/24

Self-Closing Basin Faucet and Shower Valve

B



Self-Closing Basin Faucet



Shower Valve with Pull Chain

- Chrome plated heavy duty pattern
- Deluxe aerator
- 1/2" FIP connection
- Replaceable stem, cam and spring mechanism
- Shower valves ideal for urinals when used with standpipe assembly

PART NO.	DESCRIPTION	CTN/MSTR
F39010	Basin Faucet	1/36
S05100	Shower valve with pull chain (7" chain)	1/50
S05102	Standpipe assembly for urinal	25/100
S05101	Repair kit (stem and cam mechanism)	1/10

Service Sink Faucets



Lever Handles



Cross Handles



S55352

- Integral stops; 1/4 turn for S55349
- Complete with all mounting hardware
- Integrated vacuum breaker (ASSE 1001)
- Front hook to hang bucket

PART NO.	DESCRIPTION	CTN/MSTR
S55349	Service sink faucet with lever handles	1/8
S55350	Service sink faucet with cross handles	1/6
S55351	Cross handle stem repair kit for S55350	1/100
S55352	Lever handle and stem repair kit S55349	1/50
S55353	Integral stop repair kit for S55350	1/100
S55354	Vacuum breaker repair kit for S55350	1/100

Hose & Hose Bracket for Service Sink



- Heavy duty 300 PSI cloth-reinforced hose
- 3/4" brass hose coupling at one end
- 5" x 3" stainless steel bracket with rubber grips

PART NO.	DESCRIPTION	CTN/MSTR
M05001	30" hose with bracket	1
M05005	Bracket only	1/100

Mop Hanger for Service Sink

- 24" x 3" stainless steel hanger with three rubber tool grips
- Anchors included



PART NO.	DESCRIPTION	CTN/MSTR
M05003	Mop hanger	1/25

3/8" OD Uncoated w/Fittings



- Corrugation extends all the way to the fitting for increased tubing flexibility
- CSA Design certified domestically and internationally for indoor and outdoor use
- 100% leak tested to ensure Safety and Quality and a product you can trust
- Quality flared end fittings to create a metal to metal seal in critical applications
- Durable stainless steel 304. Corrosion resistant.

PART NO.	DESCRIPTION	CTN QTY
G70000	1/2" MIP x 1/2" MIP x 12"	1/25
G70001	1/2" FIP x 1/2" FIP x 12"	1/25
G70002	3/8" FIP x 3/8" FIP x 12"	1/25
G70003	1/2" FIP x 1/2" MIP x 12"	1/25
G70004	1/2" FIP x 3/8" MIP x 12"	1/25
G70005	3/8" FIP x 1/2" MIP x 12"	1/25
G70006	3/8" FIP x 3/8" MIP x 12"	1/25
G70007	1/2" MIP x 1/2" MIP x 18"	1/25
G70008	1/2" FIP x 1/2" FIP x 18"	1/25
G70009	3/8" FIP x 3/8" FIP x 18"	1/25
G70010	1/2" FIP x 1/2" MIP x 18"	1/25
G70011	1/2" FIP x 3/8" MIP x 18"	1/25
G70012	3/8" FIP x 1/2" MIP x 18"	1/25
G70013	3/8" FIP x 3/8" MIP x 18"	1/25
G70014	1/2" MIP x 1/2" MIP x 24"	1/25
G70015	1/2" FIP x 1/2" FIP x 24"	1/25
G70016	3/8" FIP x 3/8" FIP x 24"	1/25
G70017	1/2" FIP x 1/2" MIP x 24"	1/25
G70018	1/2" FIP x 3/8" MIP x 24"	1/25
G70019	3/8" FIP x 1/2" MIP x 24"	1/25
G70020	3/8" FIP x 3/8" MIP x 24"	1/25
G70021	1/2" MIP x 1/2" MIP x 30"	1/25
G70022	1/2" FIP x 1/2" FIP x 30"	1/25
G70023	3/8" FIP x 3/8" FIP x 30"	1/25
G70024	1/2" FIP x 1/2" MIP x 30"	1/25
G70025	1/2" FIP x 3/8" MIP x 30"	1/25
G70026	3/8" FIP x 1/2" MIP x 30"	1/25
G70027	3/8" FIP x 3/8" MIP x 30"	1/25
G70028	1/2" MIP x 1/2" MIP x 36"	1/25
G70029	1/2" FIP x 1/2" FIP x 36"	1/25
G70030	3/8" FIP x 3/8" FIP x 36"	1/25
G70031	1/2" FIP x 1/2" MIP x 36"	1/25
G70032	1/2" FIP x 3/8" MIP x 36"	1/25
G70033	3/8" FIP x 1/2" MIP x 36"	1/25
G70034	3/8" FIP x 3/8" MIP x 36"	1/25
G70035	1/2" MIP x 1/2" MIP x 48"	1/25
G70036	1/2" FIP x 1/2" FIP x 48"	1/25
G70037	3/8" FIP x 3/8" FIP x 48"	1/25
G70038	1/2" FIP x 1/2" MIP x 48"	1/25
G70039	1/2" FIP x 3/8" MIP x 48"	1/25
G70040	3/8" FIP x 1/2" MIP x 48"	1/25
G70041	3/8" FIP x 3/8" MIP x 48"	1/25
G70042	1/2" MIP x 1/2" MIP x 60"	1/25
G70043	1/2" FIP x 1/2" FIP x 60"	1/25
G70044	3/8" FIP x 3/8" FIP x 60"	1/25
G70045	1/2" FIP x 1/2" MIP x 60"	1/25

3/8" OD Uncoated w/Fittings (cont.)



- Corrugation extends all the way to the fitting for increased tubing flexibility
- CSA Design certified domestically and internationally for indoor and outdoor use
- 100% leak tested to ensure Safety and Quality and a product you can trust
- Quality flared end fittings to create a metal to metal seal in critical applications
- Durable stainless steel 304. Corrosion resistant.

PART NO.	DESCRIPTION	CTN QTY
G70046	1/2" FIP x 3/8" MIP x 60"	1/25
G70047	3/8" FIP x 1/2" MIP x 60"	1/25
G70048	3/8" FIP x 3/8" MIP x 60"	1/25
G70049	1/2" MIP x 1/2" MIP x 72"	1/25
G70050	1/2" FIP x 1/2" FIP x 72"	1/25
G70051	3/8" FIP x 3/8" FIP x 72"	1/25
G70052	1/2" FIP x 1/2" MIP x 72"	1/25
G70053	1/2" FIP x 3/8" MIP x 72"	1/25
G70054	3/8" FIP x 1/2" MIP x 72"	1/25
G70055	3/8" FIP x 3/8" MIP x 72"	1/25

3/8" OD Coated w/Fittings



- Corrugation extends all the way to the fitting for increased tubing flexibility
- CSA Design certified domestically and internationally for indoor and outdoor use
- 100% leak tested to ensure Safety and Quality and a product you can trust
- Quality flared end fittings to create a metal to metal seal in critical applications
- Durable stainless steel 304. Corrosion resistant.
- Coated connectors add additional safety in highly corrosive environments or in areas where caustic chemicals are located

PART NO.	DESCRIPTION	CTN QTY
G70100	1/2" MIP x 1/2" MIP x 12"	1/25
G70101	1/2" FIP x 1/2" FIP x 12"	1/25
G70102	3/8" FIP x 3/8" FIP x 12"	1/25
G70103	1/2" FIP x 1/2" MIP x 12"	1/25
G70104	1/2" FIP x 3/8" MIP x 12"	1/25
G70105	3/8" FIP x 1/2" MIP x 12"	1/25
G70106	3/8" FIP x 3/8" MIP x 12"	1/25
G70107	1/2" MIP x 1/2" MIP x 18"	1/25
G70108	1/2" FIP x 1/2" FIP x 18"	1/25
G70109	3/8" FIP x 3/8" FIP x 18"	1/25
G70110	1/2" FIP x 1/2" MIP x 18"	1/25
G70111	1/2" FIP x 3/8" MIP x 18"	1/25
G70112	3/8" FIP x 1/2" MIP x 18"	1/25
G70113	3/8" FIP x 3/8" MIP x 18"	1/25
G70114	1/2" MIP x 1/2" MIP x 24"	1/25
G70115	1/2" FIP x 1/2" FIP x 24"	1/25
G70116	3/8" FIP x 3/8" FIP x 24"	1/25
G70117	1/2" FIP x 1/2" MIP x 24"	1/25
G70118	1/2" FIP x 3/8" MIP x 24"	1/25
G70119	3/8" FIP x 1/2" MIP x 24"	1/25
G70120	3/8" FIP x 3/8" MIP x 24"	1/25
G70121	1/2" MIP x 1/2" MIP x 30"	1/25
G70122	1/2" FIP x 1/2" FIP x 30"	1/25

3/8" OD Coated w/Fittings (cont.)



B

- Corrugation extends all the way to the fitting for increased tubing flexibility
- CSA Design certified domestically and internationally for indoor and outdoor use
- 100% leak tested to ensure Safety and Quality and a product you can trust
- Quality flared end fittings to create a metal to metal seal in critical applications
- Durable stainless steel 304. Corrosion resistant.
- Coated connectors add additional safety in highly corrosive environments or in areas where caustic chemicals are located

PART NO.	DESCRIPTION	CTN QTY
G70123	3/8" FIP x 3/8" FIP x 30"	1/25
G70124	1/2" FIP x 1/2" MIP x 30"	1/25
G70125	1/2" FIP x 3/8" MIP x 30"	1/25
G70126	3/8" FIP x 1/2" MIP x 30"	1/25
G70127	3/8" FIP x 3/8" MIP x 30"	1/25
G70128	1/2" MIP x 1/2" MIP x 36"	1/25
G70129	1/2" FIP x 1/2" FIP x 36"	1/25
G70130	3/8" FIP x 3/8" FIP x 36"	1/25
G70131	1/2" FIP x 1/2" MIP x 36"	1/25
G70132	1/2" FIP x 3/8" MIP x 36"	1/25
G70133	3/8" FIP x 1/2" MIP x 36"	1/25
G70134	3/8" FIP x 3/8" MIP x 36"	1/25
G70135	1/2" MIP x 1/2" MIP x 48"	1/25
G70136	1/2" FIP x 1/2" FIP x 48"	1/25
G70137	3/8" FIP x 3/8" FIP x 48"	1/25
G70138	1/2" FIP x 1/2" MIP x 48"	1/25
G70139	1/2" FIP x 3/8" MIP x 48"	1/25
G70140	3/8" FIP x 1/2" MIP x 48"	1/25
G70141	3/8" FIP x 3/8" MIP x 48"	1/25
G70142	1/2" MIP x 1/2" MIP x 60"	1/25
G70143	1/2" FIP x 1/2" FIP x 60"	1/25
G70144	3/8" FIP x 3/8" FIP x 60"	1/25
G70145	1/2" FIP x 1/2" MIP x 60"	1/25
G70146	1/2" FIP x 3/8" MIP x 60"	1/25
G70147	3/8" FIP x 1/2" MIP x 60"	1/25
G70148	3/8" FIP x 3/8" MIP x 60"	1/25
G70149	1/2" MIP x 1/2" MIP x 72"	1/25
G70150	1/2" FIP x 1/2" FIP x 72"	1/25
G70151	3/8" FIP x 3/8" FIP x 72"	1/25
G70152	1/2" FIP x 1/2" MIP x 72"	1/25
G70153	1/2" FIP x 3/8" MIP x 72"	1/25
G70154	3/8" FIP x 1/2" MIP x 72"	1/25
G70155	3/8" FIP x 3/8" MIP x 72"	1/25

3/8" OD Uncoated with Ball Valves



- Corrugation extends all the way to the fitting for increased tubing flexibility
- CSA Design certified domestically and internationally for indoor and outdoor use
- 100% leak tested to ensure Safety and Quality and a product you can trust
- Quality flared end fittings to create a metal to metal seal in critical applications
- Durable stainless steel 304. Corrosion resistant.

PART NO.	DESCRIPTION	CTN QTY
G70200	3/8" MIP x 1/2" FIP Ball x 12"	1/25
G70201	1/2" MIP x 1/2" FIP Ball x 12"	1/25
G70202	1/2" FIP x 1/2" FIP Ball x 12"	1/25
G70203	3/8" FIP x 1/2" FIP Ball x 12"	1/25
G70204	3/8" MIP x 1/2" FIP Ball x 18"	1/25
G70205	1/2" MIP x 1/2" FIP Ball x 18"	1/25
G70206	1/2" FIP x 1/2" FIP Ball x 18"	1/25
G70207	3/8" FIP x 1/2" FIP Ball x 18"	1/25
G70208	3/8" MIP x 1/2" FIP Ball x 24"	1/25
G70209	1/2" MIP x 1/2" FIP Ball x 24"	1/25
G70210	1/2" FIP x 1/2" FIP Ball x 24"	1/25
G70211	3/8" FIP x 1/2" FIP Ball x 24"	1/25
G70212	3/8" MIP x 1/2" FIP Ball x 30"	1/25
G70213	1/2" MIP x 1/2" FIP Ball x 30"	1/25
G70214	1/2" FIP x 1/2" FIP Ball x 30"	1/25
G70215	3/8" FIP x 1/2" FIP Ball x 30"	1/25
G70216	3/8" MIP x 1/2" FIP Ball x 36"	1/25
G70217	1/2" MIP x 1/2" FIP Ball x 36"	1/25
G70218	1/2" FIP x 1/2" FIP Ball x 36"	1/25
G70219	3/8" FIP x 1/2" FIP Ball x 36"	1/25
G70220	3/8" MIP x 1/2" FIP Ball x 48"	1/25
G70221	1/2" MIP x 1/2" FIP Ball x 48"	1/25
G70222	1/2" FIP x 1/2" FIP Ball x 48"	1/25
G70223	3/8" FIP x 1/2" FIP Ball x 48"	1/25
G70224	3/8" MIP x 1/2" FIP Ball x 60"	1/25
G70225	1/2" MIP x 1/2" FIP Ball x 60"	1/25
G70226	1/2" FIP x 1/2" FIP Ball x 60"	1/25
G70227	3/8" FIP x 1/2" FIP Ball x 60"	1/25
G70228	3/8" MIP x 1/2" FIP Ball x 72"	1/25
G70229	1/2" MIP x 1/2" FIP Ball x 72"	1/25
G70230	1/2" FIP x 1/2" FIP Ball x 72"	1/25
G70231	3/8" FIP x 1/2" FIP Ball x 72"	1/25
G70232	1/2" MIP x 1/2" FIP Angle Ball x 48"	1/25
G70233	3/8" FIP x 1/2" FIP Angle Ball x 48"	1/25
G70234	1/2" MIP x 1/2" FIP Angle Ball x 60"	1/25
G70235	3/8" FIP x 1/2" FIP Angle Ball x 60"	1/25
G70236	1/2" MIP x 1/2" FIP Angle Ball x 72"	1/25
G70237	3/8" FIP x 1/2" FIP Angle Ball x 72"	1/25

3/8" OD Coated with Ball Valves



- Corrugation extends all the way to the fitting for increased tubing flexibility
- CSA Design certified domestically and internationally for indoor and outdoor use
- 100% leak tested to ensure Safety and Quality and a product you can trust
- Quality flared end fittings to create a metal to metal seal in critical applications
- Durable stainless steel 304. Corrosion resistant.
- Coated connectors add additional safety in highly corrosive environments or in areas where caustic chemicals are located

PART NO.	DESCRIPTION	CTN QTY
G70300	3/8" MIP x 1/2" FIP Ball x 12"	1/25
G70301	1/2" MIP x 1/2" FIP Ball x 12"	1/25
G70302	1/2" FIP x 1/2" FIP Ball x 12"	1/25
G70303	3/8" FIP x 1/2" FIP Ball x 12"	1/25
G70304	3/8" MIP x 1/2" FIP Ball x 18"	1/25
G70305	1/2" MIP x 1/2" FIP Ball x 18"	1/25
G70306	1/2" FIP x 1/2" FIP Ball x 18"	1/25
G70307	3/8" FIP x 1/2" FIP Ball x 18"	1/25
G70308	3/8" MIP x 1/2" FIP Ball x 24"	1/25
G70309	1/2" MIP x 1/2" FIP Ball x 24"	1/25
G70310	1/2" FIP x 1/2" FIP Ball x 24"	1/25
G70311	3/8" FIP x 1/2" FIP Ball x 24"	1/25
G70312	3/8" MIP x 1/2" FIP Ball x 30"	1/25
G70313	1/2" MIP x 1/2" FIP Ball x 30"	1/25
G70314	1/2" FIP x 1/2" FIP Ball x 30"	1/25
G70315	3/8" FIP x 1/2" FIP Ball x 30"	1/25
G70316	3/8" MIP x 1/2" FIP Ball x 36"	1/25
G70317	1/2" MIP x 1/2" FIP Ball x 36"	1/25
G70318	1/2" FIP x 1/2" FIP Ball x 36"	1/25
G70319	3/8" FIP x 1/2" FIP Ball x 36"	1/25
G70320	3/8" MIP x 1/2" FIP Ball x 48"	1/25
G70321	1/2" MIP x 1/2" FIP Ball x 48"	1/25
G70322	1/2" FIP x 1/2" FIP Ball x 48"	1/25
G70323	3/8" FIP x 1/2" FIP Ball x 48"	1/25
G70324	3/8" MIP x 1/2" FIP Ball x 60"	1/25
G70325	1/2" MIP x 1/2" FIP Ball x 60"	1/25
G70326	1/2" FIP x 1/2" FIP Ball x 60"	1/25
G70327	3/8" FIP x 1/2" FIP Ball x 60"	1/25
G70328	3/8" MIP x 1/2" FIP Ball x 72"	1/25
G70329	1/2" MIP x 1/2" FIP Ball x 72"	1/25
G70330	1/2" FIP x 1/2" FIP Ball x 72"	1/25
G70331	3/8" FIP x 1/2" FIP Ball x 72"	1/25
G70332	1/2" MIP x 1/2" FIP Angle Ball x 48"	1/25
G70333	3/8" FIP x 1/2" FIP Angle Ball x 48"	1/25
G70334	1/2" MIP x 1/2" FIP Angle Ball x 60"	1/25
G70335	3/8" FIP x 1/2" FIP Angle Ball x 60"	1/25
G70336	1/2" MIP x 1/2" FIP Angle Ball x 72"	1/25
G70337	3/8" FIP x 1/2" FIP Angle Ball x 72"	1/25

5/8" OD Uncoated w/Fittings



- Corrugation extends all the way to the fitting for increased tubing flexibility
- CSA Design certified domestically and internationally for indoor and outdoor use
- 100% leak tested to ensure Safety and Quality and a product you can trust
- Quality flared end fittings to create a metal to metal seal in critical applications
- Durable stainless steel 304. Corrosion resistant.

PART NO.	DESCRIPTION	CTN QTY
G71000	3/4" MIP x 3/4" MIP x 12"	1/25
G71001	3/4" MIP x 1/2" MIP x 12"	1/25
G71002	1/2" MIP x 1/2" MIP x 12"	1/25
G71003	3/4" FIP x 3/4" FIP x 12"	1/25
G71004	3/4" FIP x 1/2" FIP x 12"	1/25
G71005	1/2" FIP x 1/2" FIP x 12"	1/25
G71006	1/2" FIP x 3/4" MIP x 12"	1/25
G71007	3/4" FIP x 3/4" MIP x 12"	1/25
G71008	3/4" FIP x 1/2" MIP x 12"	1/25
G71009	1/2" FIP x 1/2" MIP x 12"	1/25
G71010	3/4" MIP x 3/4" MIP x 18"	1/25
G71011	3/4" MIP x 1/2" MIP x 18"	1/25
G71012	1/2" MIP x 1/2" MIP x 18"	1/25
G71013	3/4" FIP x 3/4" FIP x 18"	1/25
G71014	3/4" FIP x 1/2" FIP x 18"	1/25
G71015	1/2" FIP x 1/2" FIP x 18"	1/25
G71016	1/2" FIP x 3/4" MIP x 18"	1/25
G71017	3/4" FIP x 3/4" MIP x 18"	1/25
G71018	3/4" FIP x 1/2" MIP x 18"	1/25
G71019	1/2" FIP x 1/2" MIP x 18"	1/25
G71020	3/4" MIP x 3/4" MIP x 24"	1/25
G71021	3/4" MIP x 1/2" MIP x 24"	1/25
G71022	1/2" MIP x 1/2" MIP x 24"	1/25
G71023	3/4" FIP x 3/4" FIP x 24"	1/25
G71024	3/4" FIP x 1/2" FIP x 24"	1/25
G71025	1/2" FIP x 1/2" FIP x 24"	1/25
G71026	1/2" FIP x 3/4" MIP x 24"	1/25
G71027	3/4" FIP x 3/4" MIP x 24"	1/25
G71028	3/4" FIP x 1/2" MIP x 24"	1/25
G71029	1/2" FIP x 1/2" MIP x 24"	1/25
G71030	3/4" MIP x 3/4" MIP x 30"	1/25
G71031	3/4" MIP x 1/2" MIP x 30"	1/25
G71032	1/2" MIP x 1/2" MIP x 30"	1/25
G71033	3/4" FIP x 3/4" FIP x 30"	1/25
G71034	3/4" FIP x 1/2" FIP x 30"	1/25
G71035	1/2" FIP x 1/2" FIP x 30"	1/25
G71036	1/2" FIP x 3/4" MIP x 30"	1/25
G71037	3/4" FIP x 3/4" MIP x 30"	1/25
G71038	3/4" FIP x 1/2" MIP x 30"	1/25
G71039	1/2" FIP x 1/2" MIP x 30"	1/25
G71040	3/4" MIP x 3/4" MIP x 36"	1/25
G71041	3/4" MIP x 1/2" MIP x 36"	1/25
G71042	1/2" MIP x 1/2" MIP x 36"	1/25
G71043	3/4" FIP x 3/4" FIP x 36"	1/25
G71044	3/4" FIP x 1/2" FIP x 36"	1/25
G71045	1/2" FIP x 1/2" FIP x 36"	1/25

B

5/8" OD Uncoated w/Fittings (cont.)



- Corrugation extends all the way to the fitting for increased tubing flexibility
- CSA Design certified domestically and internationally for indoor and outdoor use
- 100% leak tested to ensure Safety and Quality and a product you can trust
- Quality flared end fittings to create a metal to metal seal in critical applications
- Durable stainless steel 304. Corrosion resistant.

B

PART NO.	DESCRIPTION	CTN QTY
G71046	1/2" FIP x 3/4" MIP x 36"	1/25
G71047	3/4" FIP x 3/4" MIP x 36"	1/25
G71048	3/4" FIP x 1/2" MIP x 36"	1/25
G71049	1/2" FIP x 1/2" MIP x 36"	1/25
G71050	3/4" MIP x 3/4" MIP x 48"	1/25
G71051	3/4" MIP x 1/2" MIP x 48"	1/25
G71052	1/2" MIP x 1/2" MIP x 48"	1/25
G71053	3/4" FIP x 3/4" FIP x 48"	1/25
G71054	3/4" FIP x 1/2" FIP x 48"	1/25
G71055	1/2" FIP x 1/2" FIP x 48"	1/25
G71056	1/2" FIP x 3/4" MIP x 48"	1/25
G71057	3/4" FIP x 3/4" MIP x 48"	1/25
G71058	3/4" FIP x 1/2" MIP x 48"	1/25
G71059	1/2" FIP x 1/2" MIP x 48"	1/25
G71060	3/4" MIP x 3/4" MIP x 60"	1/25
G71061	3/4" MIP x 1/2" MIP x 60"	1/25
G71062	1/2" MIP x 1/2" MIP x 60"	1/25
G71063	3/4" FIP x 3/4" FIP x 60"	1/25
G71064	3/4" FIP x 1/2" FIP x 60"	1/25
G71065	1/2" FIP x 1/2" FIP x 60"	1/25
G71066	1/2" FIP x 3/4" MIP x 60"	1/25
G71067	3/4" FIP x 3/4" MIP x 60"	1/25
G71068	3/4" FIP x 1/2" MIP x 60"	1/25
G71069	1/2" FIP x 1/2" MIP x 60"	1/25
G71070	3/4" MIP x 3/4" MIP x 72"	1/25
G71071	3/4" MIP x 1/2" MIP x 72"	1/25
G71072	1/2" MIP x 1/2" MIP x 72"	1/25
G71073	3/4" FIP x 3/4" FIP x 72"	1/25
G71074	3/4" FIP x 1/2" FIP x 72"	1/25
G71075	1/2" FIP x 1/2" FIP x 72"	1/25
G71076	1/2" FIP x 3/4" MIP x 72"	1/25
G71077	3/4" FIP x 3/4" MIP x 72"	1/25
G71078	3/4" FIP x 1/2" MIP x 72"	1/25
G71079	1/2" FIP x 1/2" MIP x 72"	1/25

5/8" OD Coated w/Fittings



- Corrugation extends all the way to the fitting for increased tubing flexibility
- CSA Design certified domestically and internationally for indoor and outdoor use
- 100% leak tested to ensure Safety and Quality and a product you can trust
- Quality flared end fittings to create a metal to metal seal in critical applications
- Durable stainless steel 304. Corrosion resistant.
- Coated connectors add additional safety in highly corrosive environments or in areas where caustic chemicals are located

PART NO.	DESCRIPTION	CTN QTY
G71100	3/4" MIP x 3/4" MIP x 12"	1/25
G71101	3/4" MIP x 1/2" MIP x 12"	1/25
G71102	1/2" MIP x 1/2" MIP x 12"	1/25
G71103	3/4" FIP x 3/4" FIP x 12"	1/25
G71104	3/4" FIP x 1/2" FIP x 12"	1/25
G71105	1/2" FIP x 1/2" FIP x 12"	1/25
G71106	1/2" FIP x 3/4" MIP x 12"	1/25
G71107	3/4" FIP x 3/4" MIP x 12"	1/25
G71108	3/4" FIP x 1/2" MIP x 12"	1/25
G71109	1/2" FIP x 1/2" MIP x 12"	1/25
G71110	3/4" MIP x 3/4" MIP x 18"	1/25
G71111	3/4" MIP x 1/2" MIP x 18"	1/25
G71112	1/2" MIP x 1/2" MIP x 18"	1/25
G71113	3/4" FIP x 3/4" FIP x 18"	1/25
G71114	3/4" FIP x 1/2" FIP x 18"	1/25
G71115	1/2" FIP x 1/2" FIP x 18"	1/25
G71116	1/2" FIP x 3/4" MIP x 18"	1/25
G71117	3/4" FIP x 3/4" MIP x 18"	1/25
G71118	3/4" FIP x 1/2" MIP x 18"	1/25
G71119	1/2" FIP x 1/2" MIP x 18"	1/25
G71120	3/4" MIP x 3/4" MIP x 24"	1/25
G71121	3/4" MIP x 1/2" MIP x 24"	1/25
G71122	1/2" MIP x 1/2" MIP x 24"	1/25
G71123	3/4" FIP x 3/4" FIP x 24"	1/25
G71124	3/4" FIP x 1/2" FIP x 24"	1/25
G71125	1/2" FIP x 1/2" FIP x 24"	1/25
G71126	1/2" FIP x 3/4" MIP x 24"	1/25
G71127	3/4" FIP x 3/4" MIP x 24"	1/25
G71128	3/4" FIP x 1/2" MIP x 24"	1/25
G71129	1/2" FIP x 1/2" MIP x 24"	1/25
G71130	3/4" MIP x 3/4" MIP x 30"	1/25
G71131	3/4" MIP x 1/2" MIP x 30"	1/25
G71132	1/2" MIP x 1/2" MIP x 30"	1/25
G71133	3/4" FIP x 3/4" FIP x 30"	1/25
G71134	3/4" FIP x 1/2" FIP x 30"	1/25
G71135	1/2" FIP x 1/2" FIP x 30"	1/25
G71136	1/2" FIP x 3/4" MIP x 30"	1/25
G71137	3/4" FIP x 3/4" MIP x 30"	1/25
G71138	3/4" FIP x 1/2" MIP x 30"	1/25
G71139	1/2" FIP x 1/2" MIP x 30"	1/25
G71140	3/4" MIP x 3/4" MIP x 36"	1/25
G71141	3/4" MIP x 1/2" MIP x 36"	1/25
G71142	1/2" MIP x 1/2" MIP x 36"	1/25

5/8" OD Coated w/Fittings (cont.)



- Corrugation extends all the way to the fitting for increased tubing flexibility
- CSA Design certified domestically and internationally for indoor and outdoor use
- 100% leak tested to ensure Safety and Quality and a product you can trust
- Quality flared end fittings to create a metal to metal seal in critical applications
- Durable stainless steel 304. Corrosion resistant.
- Coated connectors add additional safety in highly corrosive environments or in areas where caustic chemicals are located

PART NO.	DESCRIPTION	CTN QTY
G71143	3/4" FIP x 3/4" FIP x 36"	1/25
G71144	3/4" FIP x 1/2" FIP x 36"	1/25
G71145	1/2" FIP x 1/2" FIP x 36"	1/25
G71146	1/2" FIP x 3/4" MIP x 36"	1/25
G71147	3/4" FIP x 3/4" MIP x 36"	1/25
G71148	3/4" FIP x 1/2" MIP x 36"	1/25
G71149	1/2" FIP x 1/2" MIP x 36"	1/25
G71150	3/4" MIP x 3/4" MIP x 48"	1/25
G71151	3/4" MIP x 1/2" MIP x 48"	1/25
G71152	1/2" MIP x 1/2" MIP x 48"	1/25
G71153	3/4" FIP x 3/4" FIP x 48"	1/25
G71154	3/4" FIP x 1/2" FIP x 48"	1/25
G71155	1/2" FIP x 1/2" FIP x 48"	1/25
G71156	1/2" FIP x 3/4" MIP x 48"	1/25
G71157	3/4" FIP x 3/4" MIP x 48"	1/25
G71158	3/4" FIP x 1/2" MIP x 48"	1/25
G71159	1/2" FIP x 1/2" MIP x 48"	1/25
G71160	3/4" MIP x 3/4" MIP x 60"	1/25
G71161	3/4" MIP x 1/2" MIP x 60"	1/25
G71162	1/2" MIP x 1/2" MIP x 60"	1/25
G71163	3/4" FIP x 3/4" FIP x 60"	1/25
G71164	3/4" FIP x 1/2" FIP x 60"	1/25
G71165	1/2" FIP x 1/2" FIP x 60"	1/25
G71166	1/2" FIP x 3/4" MIP x 60"	1/25
G71167	3/4" FIP x 3/4" MIP x 60"	1/25
G71168	3/4" FIP x 1/2" MIP x 60"	1/25
G71169	1/2" FIP x 1/2" MIP x 60"	1/25
G71170	3/4" MIP x 3/4" MIP x 72"	1/25
G71171	3/4" MIP x 1/2" MIP x 72"	1/25
G71172	1/2" MIP x 1/2" MIP x 72"	1/25
G71173	3/4" FIP x 3/4" FIP x 72"	1/25
G71174	3/4" FIP x 1/2" FIP x 72"	1/25
G71175	1/2" FIP x 1/2" FIP x 72"	1/25
G71176	1/2" FIP x 3/4" MIP x 72"	1/25
G71177	3/4" FIP x 3/4" MIP x 72"	1/25
G71178	3/4" FIP x 1/2" MIP x 72"	1/25
G71179	1/2" FIP x 1/2" MIP x 72"	1/25

5/8" OD Uncoated w/ Ball Valves



- Corrugation extends all the way to the fitting for increased tubing flexibility
- CSA Design certified domestically and internationally for indoor and outdoor use
- 100% leak tested to ensure Safety and Quality and a product you can trust
- Quality flared end fittings to create a metal to metal seal in critical applications
- Durable stainless steel 304. Corrosion resistant.

PART NO.	DESCRIPTION	CTN QTY
G71200	3/4" FIP x 3/4" FIP Ball x 12"	1/25
G71201	1/2" FIP x 3/4" FIP Ball x 12"	1/25
G71202	3/4" FIP x 1/2" FIP Ball x 12"	1/25
G71203	1/2" FIP x 1/2" FIP Ball x 12"	1/25
G71204	3/4" MIP x 3/4" FIP Ball x 12"	1/25
G71205	1/2" MIP x 3/4" FIP Ball x 12"	1/25
G71206	3/4" MIP x 1/2" FIP Ball x 12"	1/25
G71207	1/2" MIP x 1/2" FIP Ball x 12"	1/25
G71208	3/4" FIP x 3/4" FIP Ball x 18"	1/25
G71209	1/2" FIP x 3/4" FIP Ball x 18"	1/25
G71210	3/4" FIP x 1/2" FIP Ball x 18"	1/25
G71211	1/2" FIP x 1/2" FIP Ball x 18"	1/25
G71212	3/4" MIP x 3/4" FIP Ball x 18"	1/25
G71213	1/2" MIP x 3/4" FIP Ball x 18"	1/25
G71214	3/4" MIP x 1/2" FIP Ball x 18"	1/25
G71215	1/2" MIP x 1/2" FIP Ball x 18"	1/25
G71216	3/4" FIP x 3/4" FIP Ball x 24"	1/25
G71217	1/2" FIP x 3/4" FIP Ball x 24"	1/25
G71218	3/4" FIP x 1/2" FIP Ball x 24"	1/25
G71219	1/2" FIP x 1/2" FIP Ball x 24"	1/25
G71220	3/4" MIP x 3/4" FIP Ball x 24"	1/25
G71221	1/2" MIP x 3/4" FIP Ball x 24"	1/25
G71222	3/4" MIP x 1/2" FIP Ball x 24"	1/25
G71223	1/2" MIP x 1/2" FIP Ball x 24"	1/25
G71224	3/4" FIP x 3/4" FIP Ball x 30"	1/25
G71225	1/2" FIP x 3/4" FIP Ball x 30"	1/25
G71226	3/4" FIP x 1/2" FIP Ball x 30"	1/25
G71227	1/2" FIP x 1/2" FIP Ball x 30"	1/25
G71228	3/4" MIP x 3/4" FIP Ball x 30"	1/25
G71229	1/2" MIP x 3/4" FIP Ball x 30"	1/25
G71230	3/4" MIP x 1/2" FIP Ball x 30"	1/25
G71231	1/2" MIP x 1/2" FIP Ball x 30"	1/25
G71232	3/4" FIP x 3/4" FIP Ball x 36"	1/25
G71233	1/2" FIP x 3/4" FIP Ball x 36"	1/25
G71234	3/4" FIP x 1/2" FIP Ball x 36"	1/25
G71235	1/2" FIP x 1/2" FIP Ball x 36"	1/25
G71236	3/4" MIP x 3/4" FIP Ball x 36"	1/25
G71237	1/2" MIP x 3/4" FIP Ball x 36"	1/25
G71238	3/4" MIP x 1/2" FIP Ball x 36"	1/25
G71239	1/2" MIP x 1/2" FIP Ball x 36"	1/25
G71240	3/4" FIP x 3/4" FIP Ball x 48"	1/25
G71241	1/2" FIP x 3/4" FIP Ball x 48"	1/25
G71242	3/4" FIP x 1/2" FIP Ball x 48"	1/25
G71243	1/2" FIP x 1/2" FIP Ball x 48"	1/25

B

5/8" OD Uncoated w/ Ball Valves (cont.)

B



- Corrugation extends all the way to the fitting for increased tubing flexibility
- CSA Design certified domestically and internationally for indoor and outdoor use
- 100% leak tested to ensure Safety and Quality and a product you can trust
- Quality flared end fittings to create a metal to metal seal in critical applications
- Durable stainless steel 304. Corrosion resistant.

PART NO.	DESCRIPTION	CTN QTY
G71244	3/4" MIP x 3/4" FIP Ball x 48"	1/25
G71245	1/2" MIP x 3/4" FIP Ball x 48"	1/25
G71246	3/4" MIP x 1/2" FIP Ball x 48"	1/25
G71247	1/2" MIP x 1/2" FIP Ball x 48"	1/25
G71248	3/4" FIP x 3/4" FIP Ball x 60"	1/25
G71249	1/2" FIP x 3/4" FIP Ball x 60"	1/25
G71250	3/4" FIP x 1/2" FIP Ball x 60"	1/25
G71251	1/2" FIP x 1/2" FIP Ball x 60"	1/25
G71252	3/4" MIP x 3/4" FIP Ball x 60"	1/25
G71253	1/2" MIP x 3/4" FIP Ball x 60"	1/25
G71254	3/4" MIP x 1/2" FIP Ball x 60"	1/25
G71255	1/2" MIP x 1/2" FIP Ball x 60"	1/25
G71256	3/4" FIP x 3/4" FIP Ball x 72"	1/25
G71257	1/2" FIP x 3/4" FIP Ball x 72"	1/25
G71258	3/4" FIP x 1/2" FIP Ball x 72"	1/25
G71259	1/2" FIP x 1/2" FIP Ball x 72"	1/25
G71260	3/4" MIP x 3/4" FIP Ball x 72"	1/25
G71261	1/2" MIP x 3/4" FIP Ball x 72"	1/25
G71262	3/4" MIP x 1/2" FIP Ball x 72"	1/25
G71263	1/2" MIP x 1/2" FIP Ball x 72"	1/25
G71264	1/2" MIP x 3/4" FIP Angle Ball x 36"	1/25
G71265	1/2" MIP x 3/4" FIP Angle Ball x 48"	1/25
G71266	1/2" MIP x 3/4" FIP Angle Ball x 60"	1/25
G71267	1/2" MIP x 3/4" FIP Angle Ball x 72"	1/25

5/8" OD Coated w/ Ball Valves



- Corrugation extends all the way to the fitting for increased tubing flexibility
- CSA Design certified domestically and internationally for indoor and outdoor use
- 100% leak tested to ensure Safety and Quality and a product you can trust
- Quality flared end fittings to create a metal to metal seal in critical applications
- Durable stainless steel 304. Corrosion resistant.
- Coated connectors add additional safety in highly corrosive environments or in areas where caustic chemicals are located

PART NO.	DESCRIPTION	CTN QTY
G71300	3/4" FIP x 3/4" FIP Ball x 12"	1/25
G71304	3/4" MIP x 3/4" FIP Ball x 12"	1/25
G71305	1/2" MIP x 3/4" FIP Ball x 12"	1/25
G71307	1/2" MIP x 1/2" FIP Ball x 12"	1/25
G71308	3/4" FIP x 3/4" FIP Ball x 18"	1/25
G71312	3/4" MIP x 3/4" FIP Ball x 18"	1/25
G71313	1/2" MIP x 3/4" FIP Ball x 18"	1/25
G71315	1/2" MIP x 1/2" FIP Ball x 18"	1/25
G71316	3/4" FIP x 3/4" FIP Ball x 24"	1/25
G71320	3/4" MIP x 3/4" FIP Ball x 24"	1/25
G71321	1/2" MIP x 3/4" FIP Ball x 24"	1/25
G71323	1/2" MIP x 1/2" FIP Ball x 24"	1/25
G71324	3/4" FIP x 3/4" FIP Ball x 30"	1/25
G71328	3/4" MIP x 3/4" FIP Ball x 30"	1/25
G71329	1/2" MIP x 3/4" FIP Ball x 30"	1/25
G71331	1/2" MIP x 1/2" FIP Ball x 30"	1/25
G71332	3/4" FIP x 3/4" FIP Ball x 36"	1/25
G71336	3/4" MIP x 3/4" FIP Ball x 36"	1/25
G71337	1/2" MIP x 3/4" FIP Ball x 36"	1/25
G71339	1/2" MIP x 1/2" FIP Ball x 36"	1/25
G71340	3/4" FIP x 3/4" FIP Ball x 48"	1/25
G71344	3/4" MIP x 3/4" FIP Ball x 48"	1/25
G71345	1/2" MIP x 3/4" FIP Ball x 48"	1/25
G71347	1/2" MIP x 1/2" FIP Ball x 48"	1/25
G71348	3/4" FIP x 3/4" FIP Ball x 60"	1/25
G71352	3/4" MIP x 3/4" FIP Ball x 60"	1/25
G71353	1/2" MIP x 3/4" FIP Ball x 60"	1/25
G71356	3/4" FIP x 3/4" FIP Ball x 72"	1/25
G71360	3/4" MIP x 3/4" FIP Ball x 72"	1/25
G71361	1/2" MIP x 3/4" FIP Ball x 72"	1/25

1/2" OD Uncoated w/Fittings



- Corrugation extends all the way to the fitting for increased tubing flexibility
- CSA Design certified domestically and internationally for indoor and outdoor use
- 100% leak tested to ensure Safety and Quality and a product you can trust
- Quality flared end fittings to create a metal to metal seal in critical applications
- Durable stainless steel 304. Corrosion resistant.

1/2" OD Uncoated w/Fittings (cont.)



- Corrugation extends all the way to the fitting for increased tubing flexibility
- CSA Design certified domestically and internationally for indoor and outdoor use
- 100% leak tested to ensure Safety and Quality and a product you can trust
- Quality flared end fittings to create a metal to metal seal in critical applications
- Durable stainless steel 304. Corrosion resistant.

B

PART NO.	DESCRIPTION	CTN QTY
G72000	1/2" MIP x 1/2" MIP x 12"	1/25
G72001	1/2" MIP x 3/8" MIP x 12"	1/25
G72002	3/8" MIP x 3/8" MIP x 12"	1/25
G72003	1/2" FIP x 1/2" FIP x 12"	1/25
G72004	1/2" FIP x 3/8" FIP x 12"	1/25
G72005	1/2" FIP x 1/2" MIP x 12"	1/25
G72006	1/2" FIP x 3/8" MIP x 12"	1/25
G72007	3/8" FIP x 1/2" MIP x 12"	1/25
G72008	1/2" MIP x 1/2" MIP x 18"	1/25
G72009	1/2" MIP x 3/8" MIP x 18"	1/25
G72010	3/8" MIP x 3/8" MIP x 18"	1/25
G72011	1/2" FIP x 1/2" FIP x 18"	1/25
G72012	1/2" FIP x 3/8" FIP x 18"	1/25
G72013	1/2" FIP x 1/2" MIP x 18"	1/25
G72014	1/2" FIP x 3/8" MIP x 18"	1/25
G72015	3/8" FIP x 1/2" MIP x 18"	1/25
G72016	1/2" MIP x 1/2" MIP x 24"	1/25
G72017	1/2" MIP x 3/8" MIP x 24"	1/25
G72018	3/8" MIP x 3/8" MIP x 24"	1/25
G72019	1/2" FIP x 1/2" FIP x 24"	1/25
G72020	1/2" FIP x 3/8" FIP x 24"	1/25
G72021	1/2" FIP x 1/2" MIP x 24"	1/25
G72022	1/2" FIP x 3/8" MIP x 24"	1/25
G72023	3/8" FIP x 1/2" MIP x 24"	1/25
G72024	1/2" MIP x 1/2" MIP x 30"	1/25
G72025	1/2" MIP x 3/8" MIP x 30"	1/25
G72026	3/8" MIP x 3/8" MIP x 30"	1/25
G72027	1/2" FIP x 1/2" FIP x 30"	1/25
G72028	1/2" FIP x 3/8" FIP x 30"	1/25
G72029	1/2" FIP x 1/2" MIP x 30"	1/25
G72030	1/2" FIP x 3/8" MIP x 30"	1/25
G72031	3/8" FIP x 1/2" MIP x 30"	1/25
G72032	1/2" MIP x 1/2" MIP x 36"	1/25
G72033	1/2" MIP x 3/8" MIP x 36"	1/25
G72034	3/8" MIP x 3/8" MIP x 36"	1/25
G72035	1/2" FIP x 1/2" FIP x 36"	1/25
G72036	1/2" FIP x 3/8" FIP x 36"	1/25
G72037	1/2" FIP x 1/2" MIP x 36"	1/25
G72038	1/2" FIP x 3/8" MIP x 36"	1/25
G72039	3/8" FIP x 1/2" MIP x 36"	1/25
G72040	1/2" MIP x 1/2" MIP x 48"	1/25
G72041	1/2" MIP x 3/8" MIP x 48"	1/25
G72042	3/8" MIP x 3/8" MIP x 48"	1/25
G72043	1/2" FIP x 1/2" FIP x 48"	1/25
G72044	1/2" FIP x 3/8" FIP x 48"	1/25
G72045	1/2" FIP x 1/2" MIP x 48"	1/25

PART NO.	DESCRIPTION	CTN QTY
G72046	1/2" FIP x 3/8" MIP x 48"	1/25
G72047	3/8" FIP x 1/2" MIP x 48"	1/25
G72048	1/2" MIP x 1/2" MIP x 60"	1/25
G72049	1/2" MIP x 3/8" MIP x 60"	1/25
G72050	3/8" MIP x 3/8" MIP x 60"	1/25
G72051	1/2" FIP x 1/2" FIP x 60"	1/25
G72052	1/2" FIP x 3/8" FIP x 60"	1/25
G72053	1/2" FIP x 1/2" MIP x 60"	1/25
G72054	1/2" FIP x 3/8" MIP x 60"	1/25
G72055	3/8" FIP x 1/2" MIP x 60"	1/25
G72056	1/2" MIP x 1/2" MIP x 72"	1/25
G72057	1/2" MIP x 3/8" MIP x 72"	1/25
G72058	3/8" MIP x 3/8" MIP x 72"	1/25
G72059	1/2" FIP x 1/2" FIP x 72"	1/25
G72060	1/2" FIP x 3/8" FIP x 72"	1/25
G72061	1/2" FIP x 1/2" MIP x 72"	1/25
G72062	1/2" FIP x 3/8" MIP x 72"	1/25
G72063	3/8" FIP x 1/2" MIP x 72"	1/25
G72064	1/2" MIP x 3/8" FIP Angle x 36"	1/25
G72065	1/2" MIP x 3/8" FIP Angle x 48"	1/25
G72066	1/2" MIP x 3/8" FIP Angle x 72"	1/25

1/2" OD Coated w/Fittings



B

- Corrugation extends all the way to the fitting for increased tubing flexibility
- CSA Design certified domestically and internationally for indoor and outdoor use
- 100% leak tested to ensure Safety and Quality and a product you can trust
- Quality flared end fittings to create a metal to metal seal in critical applications
- Durable stainless steel 304. Corrosion resistant.
- Coated connectors add additional safety in highly corrosive environments or in areas where caustic chemicals are located

PART NO.	DESCRIPTION	CTN QTY
G72100	1/2" MIP x 1/2" MIP x 12"	1/25
G72101	1/2" MIP x 3/8" MIP x 12"	1/25
G72102	3/8" MIP x 3/8" MIP x 12"	1/25
G72103	1/2" FIP x 1/2" FIP x 12"	1/25
G72104	1/2" FIP x 3/8" FIP x 12"	1/25
G72105	1/2" FIP x 1/2" MIP x 12"	1/25
G72106	1/2" FIP x 3/8" MIP x 12"	1/25
G72107	3/8" FIP x 1/2" MIP x 12"	1/25
G72108	1/2" MIP x 1/2" MIP x 18"	1/25
G72109	1/2" MIP x 3/8" MIP x 18"	1/25
G72110	3/8" MIP x 3/8" MIP x 18"	1/25
G72111	1/2" FIP x 1/2" FIP x 18"	1/25
G72112	1/2" FIP x 3/8" FIP x 18"	1/25
G72113	1/2" FIP x 1/2" MIP x 18"	1/25
G72114	1/2" FIP x 3/8" MIP x 18"	1/25
G72115	3/8" FIP x 1/2" MIP x 18"	1/25
G72116	1/2" MIP x 1/2" MIP x 24"	1/25
G72117	1/2" MIP x 3/8" MIP x 24"	1/25
G72118	3/8" MIP x 3/8" MIP x 24"	1/25
G72119	1/2" FIP x 1/2" FIP x 24"	1/25
G72120	1/2" FIP x 3/8" FIP x 24"	1/25
G72121	1/2" FIP x 1/2" MIP x 24"	1/25
G72122	1/2" FIP x 3/8" MIP x 24"	1/25
G72123	3/8" FIP x 1/2" MIP x 24"	1/25
G72124	1/2" MIP x 1/2" MIP x 30"	1/25
G72125	1/2" MIP x 3/8" MIP x 30"	1/25
G72126	3/8" MIP x 3/8" MIP x 30"	1/25
G72127	1/2" FIP x 1/2" FIP x 30"	1/25
G72128	1/2" FIP x 3/8" FIP x 30"	1/25
G72129	1/2" FIP x 1/2" MIP x 30"	1/25
G72130	1/2" FIP x 3/8" MIP x 30"	1/25
G72131	3/8" FIP x 1/2" MIP x 30"	1/25
G72132	1/2" MIP x 1/2" MIP x 36"	1/25
G72133	1/2" MIP x 3/8" MIP x 36"	1/25
G72134	3/8" MIP x 3/8" MIP x 36"	1/25
G72135	1/2" FIP x 1/2" FIP x 36"	1/25
G72136	1/2" FIP x 3/8" FIP x 36"	1/25
G72137	1/2" FIP x 1/2" MIP x 36"	1/25
G72138	1/2" FIP x 3/8" MIP x 36"	1/25
G72139	3/8" FIP x 1/2" MIP x 36"	1/25
G72140	1/2" MIP x 1/2" MIP x 48"	1/25
G72141	1/2" MIP x 3/8" MIP x 48"	1/25
G72142	3/8" MIP x 3/8" MIP x 48"	1/25
G72143	1/2" FIP x 1/2" FIP x 48"	1/25
G72144	1/2" FIP x 3/8" FIP x 48"	1/25
G72145	1/2" FIP x 1/2" MIP x 48"	1/25

1/2" OD Coated w/Fittings (cont.)



- Corrugation extends all the way to the fitting for increased tubing flexibility
- CSA Design certified domestically and internationally for indoor and outdoor use
- 100% leak tested to ensure Safety and Quality and a product you can trust
- Quality flared end fittings to create a metal to metal seal in critical applications
- Durable stainless steel 304. Corrosion resistant.
- Coated connectors add additional safety in highly corrosive environments or in areas where caustic chemicals are located

PART NO.	DESCRIPTION	CTN QTY
G72146	1/2" FIP x 3/8" MIP x 48"	1/25
G72147	3/8" FIP x 1/2" MIP x 48"	1/25
G72148	1/2" MIP x 1/2" MIP x 60"	1/25
G72149	1/2" MIP x 3/8" MIP x 60"	1/25
G72150	3/8" MIP x 3/8" MIP x 60"	1/25
G72151	1/2" FIP x 1/2" FIP x 60"	1/25
G72152	1/2" FIP x 3/8" FIP x 60"	1/25
G72153	1/2" FIP x 1/2" MIP x 60"	1/25
G72154	1/2" FIP x 3/8" MIP x 60"	1/25
G72155	3/8" FIP x 1/2" MIP x 60"	1/25

1/2" OD Uncoated with Ball Valves



- Corrugation extends all the way to the fitting for increased tubing flexibility
- CSA Design certified domestically and internationally for indoor and outdoor use
- 100% leak tested to ensure Safety and Quality and a product you can trust
- Quality flared end fittings to create a metal to metal seal in critical applications
- Durable stainless steel 304. Corrosion resistant.

PART NO.	DESCRIPTION	CTN QTY
G72200	1/2" MIP x 1/2" FIP Ball x 12"	1/25
G72201	3/8" MIP x 1/2" FIP Ball x 12"	1/25
G72202	1/2" FIP x 1/2" FIP Ball x 12"	1/25
G72203	3/8" FIP x 1/2" FIP Ball x 12"	1/25
G72204	1/2" MIP x 1/2" FIP Ball x 18"	1/25
G72205	3/8" MIP x 1/2" FIP Ball x 18"	1/25
G72206	1/2" FIP x 1/2" FIP Ball x 18"	1/25
G72207	3/8" FIP x 1/2" FIP Ball x 18"	1/25
G72208	1/2" MIP x 1/2" FIP Ball x 24"	1/25
G72209	3/8" MIP x 1/2" FIP Ball x 24"	1/25
G72210	1/2" FIP x 1/2" FIP Ball x 24"	1/25
G72211	3/8" FIP x 1/2" FIP Ball x 24"	1/25
G72212	1/2" MIP x 1/2" FIP Ball x 30"	1/25
G72213	3/8" MIP x 1/2" FIP Ball x 30"	1/25
G72214	1/2" FIP x 1/2" FIP Ball x 30"	1/25
G72215	3/8" FIP x 1/2" FIP Ball x 30"	1/25
G72216	1/2" MIP x 1/2" FIP Ball x 36"	1/25
G72217	3/8" MIP x 1/2" FIP Ball x 36"	1/25
G72218	1/2" FIP x 1/2" FIP Ball x 36"	1/25
G72219	3/8" FIP x 1/2" FIP Ball x 36"	1/25
G72220	1/2" MIP x 1/2" FIP Ball x 48"	1/25
G72221	3/8" MIP x 1/2" FIP Ball x 48"	1/25
G72222	1/2" FIP x 1/2" FIP Ball x 48"	1/25
G72223	3/8" FIP x 1/2" FIP Ball x 48"	1/25
G72224	1/2" MIP x 1/2" FIP Ball x 60"	1/25
G72225	3/8" MIP x 1/2" FIP Ball x 60"	1/25
G72226	1/2" FIP x 1/2" FIP Ball x 60"	1/25
G72227	3/8" FIP x 1/2" FIP Ball x 60"	1/25
G72228	1/2" MIP x 1/2" FIP Ball x 72"	1/25
G72229	3/8" MIP x 1/2" FIP Ball x 72"	1/25
G72230	1/2" FIP x 1/2" FIP Ball x 72"	1/25
G72231	3/8" FIP x 1/2" FIP Ball x 72"	1/25

1/2" OD Coated w/Ball Valves



- Corrugation extends all the way to the fitting for increased tubing flexibility
- CSA Design certified domestically and internationally for indoor and outdoor use
- 100% leak tested to ensure Safety and Quality and a product you can trust
- Quality flared end fittings to create a metal to metal seal in critical applications
- Durable stainless steel 304. Corrosion resistant.
- Coated connectors add additional safety in highly corrosive environments or in areas where caustic chemicals are located

PART NO.	DESCRIPTION	CTN QTY
G72300	1/2" MIP x 1/2" FIP Ball x 12"	1/25
G72302	1/2" FIP x 1/2" FIP Ball x 12"	1/25
G72304	1/2" MIP x 1/2" FIP Ball x 18"	1/25
G72306	1/2" FIP x 1/2" FIP Ball x 18"	1/25
G72308	1/2" MIP x 1/2" FIP Ball x 24"	1/25
G72310	1/2" FIP x 1/2" FIP Ball x 24"	1/25
G72312	1/2" MIP x 1/2" FIP Ball x 30"	1/25
G72314	1/2" FIP x 1/2" FIP Ball x 30"	1/25
G72316	1/2" MIP x 1/2" FIP Ball x 36"	1/25
G72318	1/2" FIP x 1/2" FIP Ball x 36"	1/25
G72320	1/2" MIP x 1/2" FIP Ball x 48"	1/25
G72322	1/2" FIP x 1/2" FIP Ball x 48"	1/25
G72324	1/2" MIP x 1/2" FIP Ball x 60"	1/25
G72326	1/2" FIP x 1/2" FIP Ball x 60"	1/25
G72328	1/2" MIP x 1/2" FIP Ball x 72"	1/25
G72330	1/2" FIP x 1/2" FIP Ball x 72"	1/25
G72332	1/2" MIP x 1/2" FIP Angle Ball x 24"	1/25
G72333	1/2" MIP x 1/2" FIP Angle Ball x 36"	1/25
G72334	1/2" MIP x 1/2" FIP Angle Ball x 48"	1/25
G72335	1/2" MIP x 1/2" FIP Angle Ball x 72"	1/25

1" OD Coated w/Fittings



- Corrugation extends all the way to the fitting for increased tubing flexibility
- CSA Design certified domestically and internationally for indoor and outdoor use
- 100% leak tested to ensure Safety and Quality and a product you can trust
- Quality flared end fittings to create a metal to metal seal in critical applications
- Durable stainless steel 304. Corrosion resistant.
- Coated connectors add additional safety in highly corrosive environments or in areas where caustic chemicals are located

PART NO.	DESCRIPTION	CTN QTY
G71401	3/4" MIP x 3/4" FIP x 18"	1/25
G71402	3/4" MIP x 3/4" FIP x 24"	1/25
G71403	3/4" MIP x 3/4" MIP x 18"	1/25
G71404	3/4" MIP x 3/4" MIP x 24"	1/25

1/2" OD Black Coated

B



- For use with gas logs
- Corrugation extends all the way to the fitting for increased tubing flexibility
- CSA Design certified domestically and internationally for indoor and outdoor use
- 100% leak tested to ensure Safety and Quality and a product you can trust
- Quality flared end fittings to create a metal to metal seal in critical applications
- Durable stainless steel 304. Corrosion resistant.
- Coated connectors add additional safety in highly corrosive environments or in areas where caustic chemicals are located.

PART NO.	DESCRIPTION	CTN QTY
G74103	1/2" FIP x 1/2" FIP x 12"	1/25
G74105	1/2" FIP x 1/2" MIP x 12"	1/25
G74111	1/2" FIP x 1/2" FIP x 18"	1/25
G74113	1/2" FIP x 1/2" MIP x 18"	1/25
G74119	1/2" FIP x 1/2" FIP x 24"	1/25
G74121	1/2" FIP x 1/2" MIP x 24"	1/25
G74127	1/2" FIP x 1/2" FIP x 30"	1/25
G74129	1/2" FIP x 1/2" MIP x 30"	1/25
G74135	1/2" FIP x 1/2" FIP x 36"	1/25
G74137	1/2" FIP x 1/2" MIP x 36"	1/25

3/8" OD Black Coated



- For use with gas logs
- Corrugation extends all the way to the fitting for increased tubing flexibility
- CSA Design certified domestically and internationally for indoor and outdoor use
- 100% leak tested to ensure Safety and Quality and a product you can trust
- Quality flared end fittings to create a metal to metal seal in critical applications
- Durable stainless steel 304. Corrosion resistant.
- Coated connectors add additional safety in highly corrosive environments or in areas where caustic chemicals are located.

PART NO.	DESCRIPTION	CTN QTY
G73101	1/2" FIP x 1/2" FIP x 12"	1/25
G73108	1/2" FIP x 1/2" FIP x 18"	1/25
G73115	1/2" FIP x 1/2" FIP x 24"	1/25
G73122	1/2" FIP x 1/2" FIP x 30"	1/25
G73129	1/2" FIP x 1/2" FIP x 36"	1/25

Nominal Connector Series (I.D. Inches)	Straight Length Capacity - Ptu Per Hr (W) 0.64 Sp Gr.1000 Btu Per Cu Ft (37.2 MJ Per Cu Meter) Gas at @ 0.5 inch Water Column (124 Pa) Pressure Drop		
	12"	24"	36"
1/4	48000	40000	33400
3/8	102000	85000	71000
1/2	180000	150000	125000

NOTE: When using 0.2 inch water column pressure drop, capacity can be determined by multiplying the figures above by 0.632.