



SECTION A - DECORATIVE

VOLUME V



Quality
Products *for*
the Plumbing
Professional

Kitchen 1-4

Kitchen and Bath 5-9

Bathroom..... 10-27

Product Index..... 28

Part Number Index..... 29-34

Garbage Disposal Flange Stopper And Strainer Combination

Fits In-Sink-Erator



- Also acts as a basket strainer
- No tools required for installation
- Manufactured of Celcon and ABS
- Fits 3-3/8" disposal sink flange throat
- Patented design snaps in to cover existing disposal rim
- Clamshell packaging

CLAM SHELL	BOX	FINISH	BOX QTY	CTN QTY
B03001	B03001B	Polar White	1	5
B03002	B03002B	Euro White	1	5
B03003	B03003B	Biscuit	1	5
B03004	B03004B	Almond	1	5
B03005	B03005B	Black	1	5

Garbage Disposal Flange Stopper And Strainer Combination

Fits Waste King®, Whirlaway® and Sink Master®



- Also acts as a basket strainer
- No tools required for installation
- Manufactured of Celcon and ABS
- Fits 3-1/4" disposal sink flange throat
- Patented design snaps in to cover existing disposal rim
- Clamshell packaging

CLAM SHELL	BOX	FINISH	BOX QTY	CTN QTY
B03021	B03021B	Polar White	1	5
B03022	B03022B	Euro White	1	5
B03023	B03023B	Biscuit	1	5
B03024	B03024B	Almond	1	5
B03025	B03025B	Black	1	5

Garbage Disposal Flange Stopper And Strainer Combination

In-Sink-Erator Evolution Series



PART NO.	FINISH	CTN QTY
B03031	Polar White	1
B03032	Euro White	1
B03033	Biscuit	1
B03034	Almond	1
B03035	Black	1

Replacement Splash Guard For Evolution Use



PART NO.	DESCRIPTION	CTN QTY
B03000	Repl. Splash Guard	1

Disposal Assembly

Fits In-Sink-Erator



- All stainless steel construction
- Positive stopper PVD on Gold and Polished Nickel
- Clamshell package

PART NO.	FINISH	CTN QTY
B03400	Polished Stainless	1
B03401	Brushed Stainless	1
B03402	Gold (PVD)	1
B03405	Polished Nickel (PVD)	1
B03406	Oil Rubbed Bronze	1
B03407	Old World Bronze	1
B03408	Brushed Nickel	1

Polished Brass Disposal Flange And Stopper



- Flange fits all In-Sink-Erator units plus
- Badger models and classics
- Stopper fits In-Sink-Erator models 333, 333SS, 66 and 77

PART NO.	FINISH	CTN QTY
F05001	Polished Brass Flange	1
S45001	Polished Brass Stopper	1

Celcon Basket Strainers



- Manufactured of Celcon and ABS
- Simple to install, operate and maintain
- Positive seal
- Durable finish will not chip or peel
- Clamshell packaging

CLAM SHELL	BOX	FINISH	BOX QTY	CTN QTY
B02001	B02001B	Polar White	1	5
B02002	B02002B	Euro White	1	5
B02003	B02003B	Biscuit	1	5
B02004	B02004B	Almond	1	5
B02005	B02005B	Black	1	5

Basket Strainers



- Stainless steel flange and basket
- Positive seal
- PVD on Gold and Polished Nickel
- Clamshell packaging

PART NO.	FINISH	CTN QTY
B02400	Polished Stainless	1
B02401	Brushed Stainless	1
B02402	Gold (PVD)	1
B02404	Antique Nickel	1
B02405	Polished Nickel (PVD)	1
B02406	Oil Rubbed Bronze	1
B02407	Old World Bronze	1
B02408	Brushed Nickel	1

Competitive Basket Strainers



- Made of Celcon and ABS
- Attaches with locknut
- Simple to install, operate and maintain
- Durable finish that won't crack, chip or peel
- Clamshell packaging

CLAM SHELL	BOX	FINISH	BOX QTY	CTN QTY
B02020	B02020B	Polar White	1	5
B02021	B02021B	Euro White	1	5
B02022	B02022B	Biscuit	1	5
B02023	B02023B	Almond	1	5
B02024	B02024B	Black	1	5

Polished Brass Basket Strainers



- All metal construction with polished brass finish

PART NO.	FINISH	CTN QTY
B02008	Polished Brass	1

Replacement Basket Strainers



- Manufactured of Celcon and ABS
- Durable finish will not chip or peel
- Clamshell package

PART NO.	FINISH	FITS PART NO.	CTN QTY
B02301	Polar White	B02001	1
B02302	Euro White	B02002	1
B02303	Biscuit	B02003	1
B02304	Almond	B02004	1
B02305	Black	B02005	1

Duo Strainer



- PVD finish
- Cast brass

PART NO.	FINISH	CTN QTY
S14007	Chrome Plated	1
S1407BN	Brushed Nickel	1
S1407NP	Pearl Nickel	1
S1407RB	Oil Rubbed Bronze	1
S1407WB	Old World Bronze	1

Junior Duo Basket Strainer



- Complete with nuts and washers

PART NO.	FINISH	CTN QTY
B02050	Chrome Plated	1
B02100	Polished Brass	1
B0250BN	Brushed Nickel	1
B0250NP	Pearl Nickel	1
B0250RB	Oil Rubbed Bronze	1
B0250WB	Old World Bronze	1

Deep Junior Duo Basket Strainer



- Polished brass body
- Complete with nuts and washers
- For 2" and 2 1/2" outlets

PART NO.	FINISH	CTN QTY
B02102	Chrome Plated	1
B02101	Polished Brass	1

Dispenser Faucet



- 9-1/2" high
- Poly bagged
- Ceramic cartridge
- Quarter-turn handle
- Sleek European design
- For use with cold water only
- Manufactured of Celcon- will not crack, chip or peel
- Blister card packaging with 1/4" and 3/8" adapters
- Meets NSF 61.9



PART NO.	FINISH	CTN QTY
B70010	Polar White	1
B70011	Euro White	1
B70012	Biscuit	1
B70013	Almond	1
B70014	Black	1
B70017	White body chrome spout	1
B70018	Black body chrome spout	1
B70019	White body gold spout	1
B70020	Black body gold spout	1

Bar Tap Faucet



- All brass construction
- 1/2" connection
- Epoxy coated
- 1/4" inlet
- 6-1/2" high
- Blister card packaging

PART NO.	FINISH	CTN QTY
B45010	Chrome Plated	6
B70001	Polar White	1
B70003	Black	1
B70004	Old World Bronze	1
B70006	Polished Brass	1
B70007	Oil Rubbed Bronze	1
B70008	Brushed Nickel	1
B70009	Biscuit	1

Lotion And Soap Dispenser



- Fits into sink knockout
- 16 oz. refillable bottle

PART NO.	FINISH	CTN QTY
D07005	Black	1
D07008	Chrome	1

Lotion And Soap Dispenser With Brass Pump



- 2" spout
- All brass pump
- Seven ounce poly bottle
- Blister card packaging

PART NO.	FINISH	CTN QTY
S08020	Chrome Plated	1
S10020	Polished Bras	1
S10021	Polar White	1
S10022	Biscuit	1
S10023	Black	1
S10024	Oil Rubbed Bronze	1
S10025	Brushed Nickel (PVD)	1

Faucet Hole Cover



- Screw down type
- Fit all

PART NO.	FINISH	SIZE	CTN QTY
C06001	Polar White	1-3/4"	1
C06002	Almond	1-3/4"	1

Celcon Faucet Hole Cover



- Molded Celcon- will not chip or peel
- Blister card packaging

PART NO.	FINISH	CTN QTY
C06004	Polar White	1
C06005	Euro White	1
C06006	Biscuit	1
C06007	Almond	1
C06008	Black	1
C06011	Chrome	1
C06012	Gold	1
C06013	Old World Bronze	1
C06014	Brushed Nickel	1
C06016	Oil Rubbed Bronze	1
C06017	Pearl Nickel (PVD)	1
C06018	Polished Nickel (PVD)	1

Faucet Hole Cover



- Heavy duty brass construction
- 1-3/4" diameter top
- PVD on Gold and Copper Rose

PART NO.	FINISH	CTN QTY
C06020	Polished Stainless	1
C06021	Brushed Stainless	1
C06022	Gold (PVD)	1
C06024	Polished Nickel	1

Cock Hole Cover



- 1-3/4" diameter top

PART NO.	FINISH	CTN QTY
B1020AL	Almond	1
B1020AN	Antique Nickel	1
B1020BI	Biscuit	1
B1020BL	Black	1
B1020BN	Brushed Nickel (PVD)	1
B1020NP	Pearl Nickel (PVD)	1
B1020PS	Polished Stainless (PVD)	1
B1020PN	Polished Nickel	1
B1020PW	Polar White	1
B1020RB	Oil Rubbed Bronze	1
B1020WB	Old World Bronze	1

Decorative Air Gap



- Protects dishwasher from sewage backflow
- Polished brass cap or polar white cap
- Boxed
- UPC approved



PART NO.	FINISH	CTN QTY
A10001	Chrome Plated	50
A10010	Polished Brass	50
A10011	Polar White	50

Decorative Air Gap Cover



- Manufactured of Celcon- will not crack, chip or peel
- Replaces chrome cover on most air gaps
- Blister card packaging

PART NO.	FINISH	CTN QTY
A10002	Polar White	1
A10003	Euro White	1
A10004	Biscuit	1
A10005	Almond	1
A10006	Black	1
A10015	Chrome	1
A10016	Gold	1
A10017	Oil Rubbed Bronze	1
A10018	Brushed Nickel	1
A10019	Old World Bronze	1

Decorative Hose And Spray



- Reinforced hose
- Blister card packaging with 1/4" universal coupling adapter

PART NO.	FINISH	CTN QTY
K52002	Chrome Plated	10
K52010	Polar White	10
K52011	Biscuit	10
K52012	Gold	10
K52013	Black	10
K52014	Brushed Nickel	10
K52016	Oil Rubbed Bronze	10
K52017	Old World Bronze	10

Escutcheons



1/2" CTS - 5/8" OD LOW PATTERN- 2 1/2" OD

PART NO.	FINISH	CTN QTY
E01050	Chrome Plated	25
E0105BN	Brushed Nickel	1
E0105NP	Pearl Nickel	1
E0105RB	Oil Rubbed Bronze	1
E0105WB	Old World Bronze	1

1/2" IPS LOW PATTERN- 2 1/2" OD

PART NO.	FINISH	CTN QTY
E02050	Chrome Plated	25
E0205BN	Brushed Nickel	1
E0205NP	Pearl Nickel	1
E0205RB	Oil Rubbed Bronze	1
E0205WB	Old World Bronze	1

1- 1/4" TUBULAR BOX PATTERN - 3" OD

PART NO.	FINISH	CTN QTY
E04125	Chrome Plated	1
E0412BN	Brushed Nickel	1
E0412NP	Pearl Nickel	1
E0412RB	Oil Rubbed Bronze	1
E0412WB	Old World Bronze	1

1- 1/2" TUBULAR BOX PATTERN- 3" OD

PART NO.	FINISH	CTN QTY
E04150	Chrome Plated	5
E0415BN	Brushed Nickel	1
E0415NP	Pearl Nickel	1
E0415RB	Oil Rubbed Bronze	1
E0415WB	Old World Bronze	1

1/2" CTS - 5/8" OD BELL PATTERN 2- 3/8" OD

PART NO.	FINISH	CTN QTY
E07050	Chrome Plated	25
E0705BN	Brushed Nickel	1
E0705NP	Pearl Nickel	1
E0705PB	Polished Brass	1
E0705RB	Oil Rubbed Bronze	1
E0705WB	Old World Bronze	1

1/2" IPS BELL PATTERN 2-3/8" OD

PART NO.	FINISH	CTN QTY
E06050	Chrome Plated	25
E0605BN	Brushed Nickel	1
E0605NP	Pearl Nickel	1
E0605PB	Polished Brass	1
E0605RB	Oil Rubbed Bronze	1
E0605WB	Old World Bronze	1

1- 1/4" TUBULAR BELL PATTERN- 3" OD

PART NO.	FINISH	CTN QTY
E08125	Chrome Plated	25
E0812BN	Brushed Nickel	1
E0812NP	Pearl Nickel	1
E0812PB	Polished Brass	1
E0812RB	Oil Rubbed Bronze	1
E0812WB	Old World Bronze	1

1- 1/2" TUBULAR BELL PATTERN- 3" OD

PART NO.	FINISH	CTN QTY
E08150	Chrome Plated	25
E0815BN	Brushed Nickel	1
E0815NP	Pearl Nickel	1
E0815PB	Polished Brass	1
E0815RB	Oil Rubbed Bronze	1
E0815WB	Old World Bronze	1

Polished Brass Escutcheons



• Low pattern

PART NO.	DESCRIPTION	CTN QTY
E80050	1/2" CTS (5/8" OD)	25
E80075	3/4" CTS (7/8" OD)	25
E81375	3/8" IPS	25
E81050	1/2" IPS	25
E81075	3/4" IPS	25
E83125	1-1/4" OD tubular	12
E83150	1- 1/2" OD tubular	12

Box Pattern



PART NO.	DESCRIPTION	CTN QTY
E82125	1-1/4" OD tubular	12
E82150	1-1/2" OD tubular	12

Polished Brass Finish Flexible Floor And Ceiling Plates



• Plastic

PART NO.	DESCRIPTION	CTN QTY
F08375	3/8" IPS or 1/2" CTS	12
F08050	1/2" IPS or 3/4" CTS	12
F08075	3/4" IPS	12
F08099	1" CTS	12
F08100	1" IPS	12
F08124	1-1/4" CTS	12
F08125	1-1/4" IPS or 1-1/2" CTS	12
F08150	1-1/2" IPS	12
F08200	2" IPS	12
F08201	2" CTS	12

Polished Brass Finish PVC P-Trap



• Complete with nuts, washers and escutcheons

PART NO.	OD	FINISH	CTN QTY
P36100	1-1/4"	Polished Brass	1
P36101	1-1/2"	Polished Brass	1

Non-Slotted Full Flow Aerator



• Made in the USA
• Dual threads (15/16 -27 male x 55/64 -27 female)

PART NO.	FINISH	CTN QTY
A01019	Polished Brass	1

Brass Nipples



3/8" x 4"

PART NO.	FINISH	CTN QTY
N15400	Chrome Plated	1
N17375	Polished Brass	1
N2206BN	Brushed Nickel (PVD)	1
N2206NP	Pearl Nickel (PVD)	1
N2206RB	Oil Rubbed Bronze	1
N2206WB	Old World Brass	1

3/8" x 6"

PART NO.	FINISH	CTN QTY
N15600	Chrome Plated	1
N2210BN	Brushed Nickel (PVD)	1
N2210NP	Pearl Nickel (PVD)	1
N2210PB	Polished Brass	1
N2210RB	Oil Rubbed Bronze	1
N2210WB	Old World Brass	1

1/2" x 4"

PART NO.	FINISH	CTN QTY
N16400	Chrome Plated	1
N17050	Polished Brass	1
N2306BN	Brushed Nickel (PVD)	12
N2306NP	Pearl Nickel (PVD)	1
N2306RB	Oil Rubbed Bronze	1
N2306WB	Old World Brass	1

1/2" x 6"

PART NO.	FINISH	CTN QTY
N16600	Chrome Plated	1
N2310BN	Brushed Nickel (PVD)	1
N2310NP	Pearl Nickel (PVD)	1
N2310PB	Polished Brass	1
N2310WB	Old World Brass	1

Porcelain And Handicap Faucet Handles



- Available in cross handle, lever handle and wrist blade styles
- Features hot and cold buttons
- 7/16", 9/16" and 5/8" heights
- Chrome plated finish
- Celcon and brass insert adapters
- Easy to install
- Universal fit
- Clamshell packaging

PART NO.	DESCRIPTION	CTN QTY
H54004	4" Handicap wrist blade handles (pair)	1
H54007	Lever faucet handle (each)	1
H54008	Cross faucet handle (each)	1

Akralac Bar Sink



- Drilled on 4" centers with 2" drilling for drain
- High gloss polymer finish can be cleaned with liquid cleanser
- Stain-resistant finish will not crack, chip or peel under normal use
- Dimensions are 15"x 15"x 5-1/2"

PART NO.	FINISH	CTN QTY
S52001	Polar White	1
S52002	Biscuit	1
S52003	Black	1

Quarter Turn Angle Stop With 5" Sweat Extension And Escutcheon



PART NO.	FINISH	CTN QTY
S42220	Chrome Plated	1
S4222BN	Brushed Nickel	1
S4222NP	Pearl Nickel	1
S4222PB	Polished Nickel	1
S4222RB	Oil Rubbed Bronze	1
S4222WB	Old World Bronze	1

Quarter Turn Angle Stop



- Cross handle

1/2" FIP x 3/8" OD

PART NO.	FINISH	CTN QTY
S42021	Chrome Plated	1
S4202BN	Brushed Nickel	1
S4202NP	Pearl Nickel	1
S4202PB	Polished Brass	1
S4202RB	Oil Rubbed Bronze	1
S4202WB	Old World Bronze	1

5/8" FIP x 3/8" OD

PART NO.	FINISH	CTN QTY
S42031	Chrome Plated	1
S4203BN	Brushed Nickel	1
S4203NP	Pearl Nickel	1
S4203PB	Polished Brass	1
S4203RB	Oil Rubbed Bronze	1
S4203WB	Old World Bronze	1

1/2" x 3-1/2" Sleeves



PART NO.	FINISH	CTN QTY
T73300	Chrome	1
T7330BN	Brushed Nickel (PVD)	1
T7330NP	Pearl Nickel (PVD)	1
T7330PB	Polished Brass (PVD)	1
T7330RB	Oil Rubbed Bronze	1
T7330WB	Old World Bronze	1

Quarter Turn Straight Stop



1/2" FIP x 3/8" OD

PART NO.	FINISH	CTN QTY
S43021	Chrome Plated	1
S4302BN	Brushed Nickel	1
S4302NP	Pearl Nickel	1
S4302PB	Polished Brass (PVD)	1
S4302RB	Oil Rubbed Bronze	1
S4302WB	Old World Bronze	1

5/8" FIP x 3/8" OD

PART NO.	FINISH	CTN QTY
S43031	Chrome Plated	1
S4303BN	Brushed Nickel	1
S4303NP	Pearl Nickel	1
S4303PB	Polished Brass (PVD)	1
S4303RB	Oil Rubbed Bronze	1
S4303WB	Old World Bronze	1

Compression Angle Stop

5/8" COMP. x 3/8" COMP.



PART NO.	FINISH	CTN QTY
S10210	Chrome Plated	1
S4211BN	Brushed Nickel	20
S4211NP	Pearl Nickel	20
S4211PN	Polished Nickel	20
S4211RB	Oil Rubbed Bronze	20
S4211WB	Old World Bronze	20

Compression Angle Stop

1/2" FIP x 3/8" COMP.



PART NO.	FINISH	CTN QTY
S10203	Chrome Plated	1
S4213BN	Brushed Nickel	20
S4213NP	Pearl Nickel	20
S4213PN	Polished Nickel	20
S4213RB	Oil Rubbed Bronze	20
S4213WB	Old World Bronze	20

Compression Straight Stop

5/8" COMP. x 3/8" COMP.



PART NO.	FINISH	CTN QTY
S10214	Chrome Plated	1
S4312BN	Brushed Nickel	20
S4312NP	Pearl Nickel	20
S4312PN	Polished Nickel	20
S4312RB	Oil Rubbed Bronze	20
S4312WB	Old World Bronze	20

Compression Straight Stop

1/2" FIP x 3/8" COMP.



PART NO.	FINISH	CTN QTY
S10206	Chrome Plated	
S4314BN	Brushed Nickel	20
S4314NP	Pearl Nickel	20
S4314PN	Polished Nickel	20
S4314RB	Oil Rubbed Bronze	20
S4314WB	Old World Bronze	20

Closet Supply And Stop Kit



- 3/8" x 20"- Supply
- 5/8" x 3/8"- Stop
- Escutcheon

Angle

PART NO.	FINISH	CTN QTY
S10371	Polished Brass	1
S1037AP	Antique Pewter	1
S1037BB	Brushed Bronze	1
S1037BN	Brushed Nickel	1
S1037NP	Pearl Nickel	1
S1037PS	Polished Stainless	1
S1037RB	Oil Rubbed Bronze	1
S1037WB	Old World Bronze	1

Straight

PART NO.	FINISH	CTN QTY
S10381	Polished Brass	1
S1038AP	Antique Pewter	1
S1038BB	Brushed Bronze	1
S1038BN	Brushed Nickel	1
S1038NP	Pearl Nickel	1
S1038PS	Polished Stainless	1
S1038RB	Oil Rubbed Bronze	1
S1038WB	Old World Bronze	1

Polished Brass Water Supply Tubes



PART NO.	FINISH	CTN QTY
S44002	3/8" x 20" Basin Tube	12
S44003	3/8" x 12" Tank Tube	12
S44005	3/8" x 20" Tank Tube	12

Lavatory Supply And Stop Kit



- 3/8" x 20"- Supply (2 pieces)
- 5/8"x 3/8" (2 pieces)- Stop
- Escutcheon (2 pieces)

Angle

PART NO.	FINISH	CTN QTY
S10360	Chrome Plated	1
S10361	Polished Brass	1
S1036AP	Antique Pewter	1
S1036BB	Brushed Bronze	1
S1036BN	Brushed Nickel	1
S1036NP	Pearl Nickel	1
S1036PS	Polished Stainless	1
S1036RB	Oil Rubbed Bronze	1
S1036WB	Old World Bronze	1

Straight

PART NO.	FINISH	CTN QTY
S10351	Polished Brass	1
S1035AP	Antique Pewter	1
S1035BB	Brushed Bronze	1
S1035BN	Brushed Nickel	1
S1035NP	Pearl Nickel	1
S1035PS	Polished Stainless	1
S1035RB	Oil Rubbed Bronze	1
S1035WB	Old World Bronze	1

Lav Supply Tubes



• Basin supply

3/8" x 12"

PART NO.	FINISH	CTN QTY
S04020	Chrome Plated	100
S4401BN	Brushed Nickel	1
S4401NP	Pearl Nickel	1
S4401RB	Oil Rubbed Bronze	1
S4401WB	Old World Bronze	1

3/8" x 20"

PART NO.	FINISH	CTN QTY
S04022	Chrome Plated	100
S4402BN	Brushed Nickel	1
S4402NP	Pearl Nickel	1
S4402RB	Oil Rubbed Bronze	1
S4402WB	Old World Bronze	1

Closet Supply Tubes



• Tank supply

3/8" x 12"

PART NO.	FINISH	CTN QTY
S04027	Chrome Plated	100
S4403BN	Brushed Nickel	1
S4403NP	Pearl Nickel	1
S4403RB	Oil Rubbed Bronze	1
S4403WB	Old World Bronze	1

3/8 x 20"

PART NO.	FINISH	CTN QTY
S04029	Chrome Plated	100
S4405BN	Brushed Nickel	1
S4405NP	Pearl Nickel	1
S4405RB	Oil Rubbed Bronze	1
S4405WB	Old World Bronze	1

Polished Brass Diverter Spouts

- PVD durable finish
- Brass plated zamac or all brass
- Boxed



• Premium PVD polished finish

PART NO.	DESCRIPTION	MATERIAL	CONNECTION	CTN QTY
D03001	1/2" FIP	Zamac	Nose	1



• Premium PVD polished finish

PART NO.	DESCRIPTION	MATERIAL	CONNECTION	CTN QTY
D03002	3/4" x 1/2" FIP	Zamac	Base	1
D03004	1/2" CTS (5/8" OD) Slip-on with hex key	Zamac	Base	1



PART NO.	DESCRIPTION	MATERIAL	CONNECTION	CTN QTY
D03010	3/4" x 1/2" FIP with 1/2" top connection for hand-held shower	Zamac	Base	1



PART NO.	DESCRIPTION	MATERIAL	CONNECTION	CTN QTY
D03011	3/4" x 1/2" FIP with 1/2" bottom connection for hand-held shower	Zamac	Base	1



• Premium PVD polished finish

PART NO.	DESCRIPTION	MATERIAL	CONNECTION	CTN QTY
D03015	3/4" x 1/2" x 8-1/2" long	Brass	Base	1



PART NO.	DESCRIPTION	MATERIAL	CONNECTION	CTN QTY
D01032	CP slip on diverter with PB knob	Zamac	Base	1

Polished Brass Tub Spouts

- PVD durable finish
- Brass plated zamac or all brass
- Boxed



• Premium PVD polished finish

PART NO.	DESCRIPTION	MATERIAL	CONNECTION	CTN QTY
D03016	3/4" x 1/2" x 8-1/2" long	Brass	Base	1



PART NO.	DESCRIPTION	MATERIAL	CONNECTION	CTN QTY
D03020	1/2" FIP	Zamac	Nose	1

Brass Tubular P-Trap



- 17 gauge
- Brass slip joint nut and rubber washers

PART NO.	OD	FINISH	CTN QTY
P36125	1-1/4"	Polished Brass	12
P36150	1-1/2"	Polished Brass	12
P3892BN	1-1/4"	Brushed Nickel	1
P3892NP	1-1/4"	Pearl Nickel	1
P3892PB	1-1/4"	Polished Brass	1
P3892RB	1-1/4"	Oil Rubbed Bronze	1
P3892WB	1-1/4"	Old World Bronze	1

Lav Lift & Turn Drain Without Overflow Holes



- For vessel sinks
- Blister card packaging

PART NO.	FINISH	CTN QTY
P35003	Chrome Plated	1
P3500BN	Brushed Nickel (PVD)	1
P3500NP	Pearl Nickel (PVD)	1
P3500PB	Polished Brass	1
P3500RB	Oil Rubbed Bronze	1
P3500WB	Old World Bronze	1

Lav Drain Without Overflow



- For vessel sinks
- Blister card packaging

PART NO.	FINISH	CTN QTY
D70105	Chrome Plated	1
D7010BN	Brushed Nickel	5
D7010NP	Pearl Nickel	5
D7010PB	Polished Brass	5
D7010RB	Oil Rubbed Bronze	5
D7010WB	Old World Bronze	5

Polished Brass Pop-Up Assembly



- PVD durable finish
- All metal construction
- Tool free locknut and ballrod nut
- 1-1/4" tubular
- 17 gauge
- Boxed

PART NO.	FINISH	CTN QTY
P35001	Chrome Plated	25
P35002	Polished Brass Pop-Up	10

Replacement Parts

PART NO.	FINISH	CTN QTY
P35920	Plunger	25
P35921	Flange	25
P35922	Lift Rod	25

Ceiling Mount Shower Arm



- 1/2" female threads

1/2" x 6"

PART NO.	FINISH	CTN QTY
S01051	Chrome Plated	10
S01151	Polished Brass (PVD)	10
S0151BN	Brushed Nickel	10
S0151NP	Pearl Nickel	10
S0151RB	Oil Rubbed Bronze	10
S0151WB	Old World Bronze	10

1/2" x 12"

PART NO.	FINISH	CTN QTY
S01052	Chrome Plated	10
S01152	Polished Brass (PVD)	10
S0152BN	Brushed Nickel	10
S0152NP	Pearl Nickel	10
S0152RB	Oil Rubbed Bronze	10
S0152WB	Old World Bronze	10

1/2" x 18"

PART NO.	FINISH	CTN QTY
S01053	Chrome Plated	10
S01153	Polished Brass (PVD)	10
S0153BN	Brushed Nickel	10
S0153NP	Pearl Nickel	10
S0153RB	Oil Rubbed Bronze	10
S0153WB	Old World Bronze	10

S-Shaped Shower Arm



- 18" length
- Adds 12" to height
- 1/2" female threads

PART NO.	FINISH	CTN QTY
S01055	Chrome Plated	1
S01155	Polished Brass (PVD)	1
S0155BN	Brushed Nickel	1
S0155NP	Pearl Nickel	1
S0155RB	Oil Rubbed Bronze	1
S0155WB	Old World Bronze	1

Double Offset Shower Arm



- 18" length
- 1/2" female threads
- Adds 12" to height

PART NO.	FINISH	CTN QTY
S01058	Chrome Plated	1
S01158	Polished Brass (PVD)	1
S0158BN	Brushed Nickel	1
S0158NP	Pearl Nickel	1
S0158RB	Oil Rubbed Bronze	1
S0158WB	Old World Bronze	1

90° Shower Arm With Flange



- 18" length
- 1/2" female threads

PART NO.	FINISH	CTN QTY
S01056	Chrome Plated	1
S01156	Polished Brass	1
S0156BN	Brushed Nickel	1
S0156NP	Pearl Nickel	1
S0156RB	Oil Rubbed Bronze	1
S0156WB	Old World Bronze	1

Shower Arm



- Solid Brass

6" Arm

PART NO.	FINISH	CTN QTY
S01030	Chrome Plated	1
S0130BN	Brushed Nickel	1
S0130NP	Pearl Nickel	1
S0130RB	Oil Rubbed Bronze	1
S0130WB	Old World Bronze	1

8" Arm

PART NO.	FINISH	CTN QTY
S01032	Chrome Plated	1
S0132BN	Brushed Nickel	1
S0132NP	Pearl Nickel	1
S0132RB	Oil Rubbed Bronze	1
S0132WB	Old World Bronze	1

Raised Bend Shower Arm



- 18" length
- 1/2" female threads

PART NO.	FINISH	CTN QTY
S01057	Chrome Plated	1
S01157	Polished Brass (PVD)	1
S0157BN	Brushed Nickel	1
S0157NP	Pearl Nickel	1
S0157RB	Oil Rubbed Bronze	1
S0157WB	Old World Bronze	1

Polished Brass Shower Arm



- Solid Brass

PART NO.	DESCRIPTION	CTN QTY
S03030	1/2" x 6"	1
S03032	1/2" x 8"	1
S01036	1/2" x 8" s-style	1
S01037	1/2" x 10 s-style	1

Contoured Shower Curtain Rods

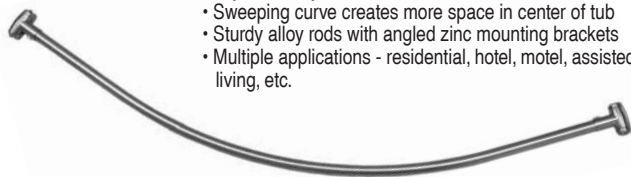

- Brings shower curtain in front of wall to prevent gaps and leaks.
- Perfect for 60" oval and standard tubs.
- Adjusts easily with tube cutters for shower walls.
- Sweeping curve creates more space in center of tub
- Sturdy alloy rods with angled zinc mounting brackets
- Multiple applications - residential, hotel, motel, assisted living, etc.

PART NO.	FINISH	CTN QTY
S02190	Chrome Plated	1
S02191	Polar White	1
S02193	Satin Nickel	1

Flanges

PART NO.	FINISH	CTN QTY
S02290	Chrome Flanges (Fits S02190)	1
S02291	White Flanges (Fits S02191)	1
S02293	Satin Nickel Flanges (Fits S02193)	1

Polished Brass Shower Arm Flange



- The S03-040 is die cast with a set screw
- Poly bagged

PART NO.	FINISH	CTN QTY
S03040	1/2" with set screw	5

Polished Brass Shower Rod Flange With Set Screws



- Includes: two flanges, two set screws and four wood screws

PART NO.	FINISH	CTN QTY
S03152	Shower Rod Flange	1

Polished Brass Jiffy Rod Flanges



- Die Cast

PART NO.	FINISH	CTN QTY
S03151	Metal Jiffy Rod Holder	1

3" Adjustable Shower Head



- 2.5 GPM
- Solid Brass

PART NO.	FINISH	CTN QTY
S01010	Chrome Plated	1
S0101BN	Brushed Nickel	1
S0101NP	Pearl Nickel	1
S0101RB	Oil Rubbed Bronze	1
S0101WB	Old World Bronze	1

Curved Claw Shower Head



- 5 or 6 Curved claw sprays
- Center spray
- 1/2" swivel connection

5 Claw

PART NO.	FINISH	CTN QTY
S01082	Chrome Plated	1
S01182	Polished Brass	1

6 Claw

PART NO.	FINISH	CTN QTY
S01083	Chrome Plated	1
S01183	Polished Brass	1

Classic Shower Head



• 1/2" swivel connection

PART NO.	FINISH	SIZE	CTN QTY
S01087	Chrome Plated	5"	1
S01187	Polished Brass	5"	1
S0187BN	Brushed Nickel	5"	1
S0187NP	Pearl Nickel	5"	1
S0187RB	Oil Rubbed Bronze	5"	1
S0187WB	Old World Bronze	5"	1

Round Rain Style Shower Head w/Dimples



• 1/2" swivel connection

Diameter - 5"

PART NO.	FINISH	SIZE	CTN QTY
S01088	Chrome Plated	5"	1
S0188BN	Brushed Nickel	5"	1
S0188RB	Oil Rubbed Bronze	5"	1
S0188WB	Old World Bronze	5"	1

Diameter - 8"

PART NO.	FINISH	SIZE	CTN QTY
S01089	Chrome Plated	8"	1
S0189BN	Brushed Nickel	8"	1
S0189RB	Oil Rubbed Bronze	8"	1
S0189WB	Old World Bronze	8"	1

Round Shower Head With Tips



• 1/2" swivel connection

Diameter - 6"

PART NO.	DIAMETER	FINISH	CTN QTY
S01084	6"	Chrome Plated	1
S01184	6"	Polished Brass	1
S0184BN	6"	Brushed Nickel	1
S0184NP	6"	Pearl Nickel	1
S0184RB	6"	Oil Rubbed Bronze	1
S0184WB	6"	Old World Bronze	1

Diameter - 8"

PART NO.	DIAMETER	FINISH	CTN QTY
S01085	8"	Chrome Plated	1
S01185	8"	Polished Brass	1
S0185BN	8"	Brushed Nickel	1
S0185NP	8"	Pearl Nickel	1
S0185RB	8"	Oil Rubbed Bronze	1
S0185WB	8"	Old World Bronze	1

Diameter - 10"

PART NO.	DIAMETER	FINISH	CTN QTY
S01086	10"	Chrome Plated	1
S01186	10"	Polished Brass (PVD)	1
S0186BN	10"	Brushed Nickel	1
S0186NP	10"	Pearl Nickel	1
S0186RB	10"	Oil Rubbed Bronze	1
S0186WB	10"	Old World Bronze	1

Round Shower Head With Gold Tips



• Chrome plated body with gold tips (removable)
• 1/2" swivel connection

PART NO.	SIZE	CTN QTY
S01090	5"	20
S01091	9"	12

Polished Brass Shower Head & Kit



• Shower head is solid brass with PVD finish
• Adjustable
• 2.5 GPM at 80 psi

PART NO.	SIZE	CTN QTY
S03009	2-1/4" polished brass shower head	1
S03051	Kit with arm and flange with set screws	1

Polished Brass Tub Trip Lever w/ Spring



• Includes screws

PART NO.	# HOLES	FINISH	CTN QTY
T05003	2	Chrome Plated	25
T08003	2	Polished Brass	1
T08004	2	PVD Polished Brass	1

Overflow Plates

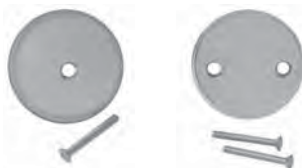

• Includes screws

PART NO.	# HOLES	FINISH	CTN QTY
T08012	1	Polished Brass	1
T08013	2	Polished Brass	1
T05015	2	White	1
P35616	2	Satin Nickel	1

PVD Polished Brass Overflow Plates



• Includes screws

PART NO.	# HOLES	FINISH	CTN QTY
T08112	1	PVD Durable Finish	1
T08113	2	PVD Durable Finish	1

Waste And Overflow Faceplate w/Screw



• Includes screws

PART NO.	# HOLES	FINISH	CTN QTY
T05012	1	Chrome Plated	25
T0812BN	1	Brushed Nickel	1
T0812NP	1	Pearl Nickel	1
T0812RB	1	Oil Rubbed Bronze	1
T0812WB	1	Old World Bronze	1

Polished Brass Bath Waste Conversion Kits



- Converts regular bath waste to polished brass
- Fits 1-3/8" or 1-1/2" waste elbows
- Includes drain, bushing, face plate, and 2 screws
- Blister card packaging

For Trip Lever Washers

PART NO.	# HOLES	SIZE	CTN QTY
B51001	2	1-1/2" and 1-3/8"	12

For Toe Touch Wastes

PART NO.	# HOLES	SIZE	CTN QTY
B51002	2	1-1/2" and 1-3/8"	12

For Lift and Turn Wastes

PART NO.	# HOLES	SIZE	CTN QTY
B51003	2	1-1/2" and 1-3/8"	12
B51020	1	1-1/2" and 1-3/8"	12

Decorative Lift And Turn Conversion Kit



- 1-Hole face plate
- Clamshell packaging
- Aluminum adapter bar
- 1-3/8" drain with bushing
- Includes drain, bushing, face plate and screw
- Blister card packaging

PART NO.	# HOLES	FINISH	CTN QTY
B51019	1	Chrome Plated	1
B5160AP	1	Antique Pewter	1
B5160BB	1	Brushed Bronze	1
B5160BN	1	Brushed Nickel	1
B5160NP	1	Pearl Nickel	1
B5160RB	1	Oil Rubbed Bronze	1
B5160WB	1	Old World Bronze	1
B5160BS	1	Brushed Stainless	1
B5160PN	1	Polished Nickel	1
B5160PS	1	Polished Stainless	1

Toe Touch Conversion Kit



- With aluminum adapter bar
- 1-3/8" drain with bushing, screw and faceplate
- Clamshell packaging

PART NO.	# HOLES	FINISH	CTN QTY
B51010	1	Chrome Plated	1
B5161AP	1	Antique Pewter	1
B5161BB	1	Brushed Bronze	1
B5161BN	1	Brushed Nickel	1
B5161NP	1	Pearl Nickel	1
B5161PS	1	Polished Stainless	1
B5161RB	1	Oil Rubbed Bronze	1
B5161WB	1	Old World Bronze	1

Lift And Turn Conversion Kits



- 1-3/8" drain with bushing, screw and faceplate
- Clamshell packaging

PART NO.	# HOLES	FINISH	CTN QTY
B51005	2	Chrome Plated	1
B51004	2	Satin Nickel	1
B5155AB	2	Antique Brass	1
B5155AP	2	Antique Pewter	1
B5155AL	2	Almond	1
B5155AN	2	Antique Nickel	1
B5155BB	2	Brushed Bronze	1
B5155BI	2	Biscuit	1
B5155BL	2	Black	1
B5155BN	2	Brushed Nickel	1
B5155BS	2	Brushed Stainless	1
B5155NP	2	Pearl Nickel	1
B5155PS	2	Polished Stainless	1
B5155PW	2	Polar White	1
B5155RB	2	Oil Rubbed Bronze	1
B5155WB	2	Old World Bronze	1

Toe Touch Conversion Kits



- Fits 1-3/8" or 1-1/2" waste elbows
- Includes drain, bushing, face plate and 2 screws
- Clamshell packaging

PART NO.	# HOLES	FINISH	CTN QTY
B51007	2	Chrome Plated	1
B5156AP	2	Antique Pewter	1
B5156BB	2	Brushed Bronze	1
B5156BN	2	Brushed Nickel	1
B5156NP	2	Pearl Nickel	1
B5156PS	2	Polished Stainless	1
B5156RB	2	Oil Rubbed Bronze	1
B5156WB	2	Old World Bronze	1

Trip Lever Conversion Kits



- Fits 1-3/8" or 1-1/2" waste elbows
- Includes drain, bushing, face plate and 2 screws
- Clamshell packaging

PART NO.	# HOLES	FINISH	CTN QTY
B51015	2	Chrome Plated	5
B5112AP	2	Antique Pewter	1
B5112BI	2	Biscuit	1
B5112BB	2	Brushed Bronze	1
B5112BN	2	Brushed Nickel	1
B5112BS	2	Brushed Stainless	1
B5112NP	2	Pearl Nickel	1
B5112PW	2	Polar White	1
B5112RB	2	Oil Rubbed Bronze	1
B5112WB	2	Old World Bronze	1

Trip Lever Trim Only



- Clamshell packaging
- Includes faceplate, screws and strainer

PART NO.	# HOLES	FINISH	CTN QTY
B51014	2	Chrome Plated	1
B5114AP	2	Antique Pewter	1
B5114BB	2	Brushed Bronze	1
B5114BN	2	Brushed Nickel	1
B5114NP	2	Pearl Nickel	1
B5114PB	2	Polished Brass	1
B5114PN	2	Polished Nickel	1
B5114RB	2	Oil Rubbed Bronze	1
B5114PS	2	Polished Stainless	1
B5114WB	2	Old World Bronze	1

Trip Lever Faceplate And Handle



PART NO.	# HOLES	FINISH	CTN QTY
T05002	2	Chrome Plated	25
P3566AB	2	Antique Brass	1
P3566AL	2	Almond	1
P3566AN	2	Antique Nickel	1
P3566BI	2	Biscuit	1
P3566BL	2	Black	1
P3566BN	2	Brushed Nickel	1
P3566BS	2	Brushed Stainless	1
P3566NP	2	Pearl Nickel	1
P3566PN	2	Polished Nickel	1
P3566PS	2	Polished Stainless	1
P3566PW	2	Polar White	1
P3566RB	2	Oil Rubbed Bronze	1
P3566WB	2	Old World Bronze	1

Two-Hole Overflow Faceplate And Screws



PART NO.	# HOLES	FINISH	CTN QTY
T05013	2	Chrome Plated	25
T0813BN	2	Brushed Nickel	1
T0813NP	2	Pearl Nickel	1
T0813PW	2	Polar White	1
T0813RB	2	Oil Rubbed Bronze	1
T0813WB	2	Old World Bronze	1

PB Satin Nickel / Faceplate Screws



PART NO.	FINISH	SIZE	CTN QTY
T08021	Polished Brass	1/4" x 2"	25
P35615	Satin Nickel	1/4" x 2"	25

Waste And Overflow Faceplate Screws



PART NO.	FINISH	CTN QTY
T05021	Chrome Plated	1
T0521AB	Antique Brass	1
T0521AL	Almond	1
T0521AN	Antique Nickel	1
T0521BI	Biscuit	1
T0521BL	Black	1
T0521BN	Brushed Nickel	1
T0521BS	Brushed Stainless	1
T0521NP	Pearl Nickel	1
T0521PN	Polished Nickel	1
T0521PS	Polished Stainless	1
T0521PW	Polar White	1
T0521RB	Oil Rubbed Bronze	1
T0521WB	Old World Bronze	1

Waste And Overflow Faceplate Only



• 2 holes

PART NO.	# HOLES	FINISH	CTN QTY
T05011	2	Chrome Plated	25
P3565AB	2	Antique Brass	1
P3565AL	2	Almond	1
P3565AN	2	Antique Nickel	1
P3565BI	2	Biscuit	1
P3565BL	2	Black	1
P3565BN	2	Brushed Nickel	1
P3565BS	2	Brushed Stainless	1
P3565NP	2	Pearl Nickel	1
P3565PN	2	Polished Nickel	1
P3565PS	2	Polished Stainless	1
P3565PW	2	Polar White	1
P3565RB	2	Oil Rubbed Bronze	1
P3565WB	2	Old World Bronze	1

Flip-It Conversion Kit



- No tools needed for installation
- Open or close with a flip of the toe
- Fits most popular tub drains (assorted o-ring included)
- One piece construction Delrin and ABS

PART NO.	FINISH	CTN QTY
P35170	Chrome Plated	1
P35171	Polished Brass	1
P35172	Brushed Nickel	1

Flip-It Tub Stopper



- No tools needed for installation
- Open or close with a flip of the toe
- Fits most popular tub drains (assorted o-ring included)
- One piece construction Delrin and ABS

PART NO.	FINISH	CTN QTY
P35070	Chrome Plated	12
P35071	Polished Brass	12

Bath Drains



PART NO.	DESCRIPTION	CTN QTY
P35061	1-3/8" CP Lift and Turn Drain	1
P35051	1-3/8" PB Lift and Turn Drain	1
P35060	1-1/2" CP Lift and Turn Drain	1
P35050	1-1/2" PB Lift and Turn Drain	1
P35065	1-1/2" White Lift and Turn Drain	1



PART NO.	DESCRIPTION	CTN QTY
P35063	1-3/8" CP Pop-Up Drain	1
P35053	1-3/8" PB Pop-Up Drain	1
P35062	1-1/2" CP Pop-Up Drain	1
P35052	1-1/2" PB Pop-Up Drain	1



PART NO.	DESCRIPTION	CTN QTY
P35056	5/16" CP Pop-Up Cartridge	1
P35055	5/16" PB Pop-Up Cartridge	1



PART NO.	DESCRIPTION	CTN QTY
T05024	1-3/8" - 1-1/2" Bushing	1

Polished Brass/Satin Nickel Bath Drains



• PVD durable finish

PART NO.	DESCRIPTION	FINISH	CTN QTY
P35072	1-1/2" Lift and Turn	Polished Brass	1
P35073	1-1/2" Pop-Up	Polished Brass	1
P35068	1-1/2" Friction Lift	Polished Brass	1
P35058	3/8" Replacement	Polished Brass	1
P35610	1-1/2" Lift and Turn	Satin Nickel	1
P35611	1-1/2" Friction Lift	Satin Nickel	1
P35612	1-1/2" Toe Touch	Satin Nickel	1
P35613	1-1/2" Trip Lever	Satin Nickel	1
P35614	1-1/2" Cable Drive	Satin Nickel	1

Trip Lever Body, Grid And Screw



PART NO.	FINISH	CTN QTY
P35064	Chrome Plated	1
P3563AB	Antique Brass	1
P3563AL	Almond	1
P3563AN	Antique Nickel	1
P3563BI	Biscuit	1
P3563BL	Black	1
P3563BN	Brushed Nickel	1
P3563BS	Brushed Stainless	1
P3563NP	Pearl Nickel	1
P3563PN	Polished Nickel	1
P3563PS	Polished Stainless	1
P3563PW	Polar White	1
P3563RB	Oil Rubbed Bronze	1
P3563WB	Old World Bronze	1

Toe Touch Tub Drain



PART NO.	FINISH	CTN QTY
P35062	Chrome Plated	1
P3562AB	Antique Brass	1
P3562AL	Almond	1
P3562AN	Antique Nickel	1
P3562BI	Biscuit	1
P3562BL	Black	1
P3562BN	Brushed Nickel	1
P3562BS	Brushed Stainless	1
P3562NP	Pearl Nickel	1
P3562PN	Polished Nickel	1
P3562PS	Polished Stainless	1
P3562PW	Polar White	1
P3562RB	Oil Rubbed Bronze	1
P3562WB	Old World Bronze	1

Lift And Turn Tub Drain



• Solid Brass
• Body and stopper

PART NO.	FINISH	CTN QTY
P3560AB	Antique Brass	1
P3560AL	Almond	1
P3560AN	Antique Nickel	1
P3560BI	Biscuit	1
P3560BL	Black	1
P3560BN	Brushed Nickel	1
P3560BS	Brushed Stainless	1
P35066	Chrome Plated	1
P3560NP	Pearl Nickel	1
P35050	Polished Brass	1
P3560PN	Polished Nickel	1
P3560PS	Polished Stainless	1
P3560PW	Polar White	1
P3560RB	Oil Rubbed Bronze	1
P3560WB	Old World Bronze	1
P35610	Satin Nickel	1

Friction Lift Tub Drain



• Solid Brass

PART NO.	FINISH	CTN QTY
P35067	Chrome Plated	1
P3561AB	Antique Brass	1
P3561AL	Almond	1
P3561AN	Antique Nickel	1
P3561BI	Biscuit	1
P3561BL	Black	1
P3561BN	Brushed Nickel	1
P3561BS	Brushed Stainless	1
P3561NP	Pearl Nickel	1
P35068	Polished Brass	1
P3561PN	Polished Nickel	1
P3561PS	Polished Stainless	1
P3561PW	Polar White	1
P3561RB	Oil Rubbed Bronze	1
P3561WB	Old World Bronze	1
P35611	Satin Nickel	1

Standard One-Hole Schedule 40 Lift & Turn Half Kit



PVC#	ABS#	FINISH	CTN QTY
B07010	B07011	Chrome Plated	1
B0750BN	B0850BN	Brushed Nickel	1
B0750NP	B0850NP	Pearl Nickel	1
B0750RB	B0850RB	Oil Rubbed Bronze	1
B0750WB	B0850WB	Old World Bronze	1
B07014	B07015	Polished Brass	1

Standard One-Hole Schedule 40 Lift & Turn Full Kit



PVC#	ABS#	FINISH	CTN QTY
B07030	B07031	Chrome Plated	1
B0751BN	B0851BN	Brushed Nickel	1
B0751NP	B0851NP	Pearl Nickel	1
B0751RB	B0851RB	Oil Rubbed Bronze	1
B0751WB	B0851WB	Old World Bronze	1
B07034	B07035	Polished Brass	1

Standard One-Hole Schedule 40 Friction Lift Half Kit



PVC#	ABS#	FINISH	CTN QTY
B07052	B07053	Chrome Plated	1
B0752BN	B0852BN	Brushed Nickel	1
B0752NP	B0852NP	Pearl Nickel	1
B0752RB	B0852RB	Oil Rubbed Bronze	1
B0752WB	B0852WB	Old World Bronze	1
B07054	B07055	Polished Brass	1

Standard One-Hole Schedule 40 Friction Lift Full Kit



PVC#	ABS#	FINISH	CTN QTY
B07058	B07059	Chrome Plated	1
B0753BN	B0853BN	Brushed Nickel	1
B0753NP	B0853NP	Pearl Nickel	1
B0753RB	B0853RB	Oil Rubbed Bronze	1
B0753WB	B0853WB	Old World Bronze	1
B07060	B07061	Polished Brass	1

Standard One-Hole Schedule 40 Toe Touch Half Kit



PVC#	ABS#	FINISH	CTN QTY
B07012	B07013	Chrome Plated	24
B0754BN	B0854BN	Brushed Nickel	1
B0754NP	B0854NP	Pearl Nickel	1
B0754RB	B0854RB	Oil Rubbed Bronze	1
B0754WB	B0854WB	Old World Bronze	1
B07016	B07017	Polished Brass	1

**Standard One-Hole Schedule 40
Toe Touch Full Kit**



PVC#	ABS#	FINISH	CTN QTY
B07032	B07033	Chrome Plated	1
B0755BN	B0855BN	Brushed Nickel	1
B0755NP	B0855NP	Pearl Nickel	1
B0755RB	B0855RB	Oil Rubbed Bronze	1
B0755WB	B0855WB	Old World Bronze	1
B07036	B07037	Polished Brass	1

**Standard Two-Hole Schedule 40
Lift And Turn Full Kit**



PVC#	ABS#	FINISH	CTN QTY
B07130	B07131	Chrome Plated	1
B0713AL	B0813AL	Almond	1
B0713AB	B0813AB	Antique Brass	1
B0713AN	B0813AN	Antique Nickel	1
B0713BI	B0813BI	Biscuit	1
B0713BL	B0813BL	Black	1
B0713BN	B0813BN	Brushed Nickel	1
B0713NP	B0813NP	Pearl Nickel	1
B0713PN	B0813PN	Pearl Nickel	1
B0713PS	B0813PS	Polished Stainless	1
B0713PW	B0813PW	Polar White	1
B0713RB	B0813RB	Oil Rubbed Bronze	1
B0713WB	B0813WB	Old World Bronze	1
B07134	B07135	Polished Brass	1

**Standard Two-Hole Schedule 40
Lift & Turn Half Kit**



PVC#	ABS#	FINISH	CTN QTY
B07110	B07111	Chrome Plated	1
B0711AB	B0811AB	Antique Brass	1
B0711AL	B0811AL	Almond	1
B0711AN	B0811AN	Antique Nickel	1
B0711BI	B0811BI	Biscuit	1
B0711BL	B0811BL	Black	1
B0711BN	B0811BN	Brushed Nickel	1
B0711BS	B0811BS	Brushed Stainless	1
B0711NP	B0811NP	Pearl Nickel	1
B0711PN	B0811PN	Polished Nickel	1
B0711PS	B0811PS	Polished Stainless	1
B0711PW	B0811PW	Polar White	1
B0711RB	B0811RB	Oil Rubbed Bronze	1
B0711WB	B0811WB	Old World Bronze	1
B07114	B07115	Polished Brass	1

**Standard Two-Hole Schedule 40
Toe Touch Half Kit**



PVC#	ABS#	FINISH	CTN QTY
B07112	B07113	Chrome Plated	1
B0717AB	B0817AB	Antique Brass	1
B0717AL	B0817AL	Almond	1
B0717AN	B0817AN	Antique Nickel	1
B0717BI	B0817BI	Biscuit	1
B0717BL	B0817BL	Black	1
B0717BN	B0817BN	Brushed Nickel	1
B0717BS	B0817BS	Brushed Stainless	1
B0717NP	B0817NP	Pearl Nickel	1
B0717PN	B0817PN	Polished Nickel	1
B0717PS	B0817PS	Polished Stainless	1
B0717PW	B0817PW	Polar White	1
B0717RB	B0817RB	Oil Rubbed Bronze	1
B0717WB	B0817WB	Old World Bronze	1
B07116	B07117	Polished Brass	1

Standard Two-Hole Schedule 40 Friction Lift Full Kit



PVC#	ABS#	FINISH	CTN QTY
B07158	B07159	Chrome Plated	1
B0716AB	B0816AB	Antique Brass	1
B0716AL	B0816AL	Almond	1
B0716AN	B0816AN	Antique Nickel	1
B0716BI	B0816BI	Biscuit	1
B0716BL	B0816BL	Black	1
B0716BN	B0816BN	Brushed Nickel	1
B0716BS	B0816BS	Brushed Stainless	1
B0716NP	B0816NP	Pearl Nickel	1
B0716PN	B0816PN	Polished Nickel	1
B0716PS	B0816PS	Polished Stainless	1
B0716PW	B0816PW	Polar White	1
B0716RB	B0816RB	Oil Rubbed Bronze	1
B0716WB	B0816WB	Old World Bronze	1
B07160	B07161	Polished Brass	1

Standard Two-Hole Schedule 40 Toe Touch Full Kit



PVC#	ABS#	FINISH	CTN QTY
B07132	B07133	Chrome Plated	1
B0718AL	B0718AL	Almond	1
B0718AB	B0818AB	Antique Brass	1
B0718AN	B0818AN	Antique Nickel	1
B0718BI	B0818BI	Biscuit	1
B0718BL	B0818BL	Black	1
B0718BN	B0818BN	Brushed Nickel	1
B0718NP	B0818NP	Pearl Nickel	1
B0718PN	B0818PN	Polished Nickel	1
B0718PS	B0818PS	Polished Stainless	1
B0718PW	B0818PW	Polar White	1
B0718RB	B0818RB	Oil Rubbed Bronze	1
B0718WB	B0818WB	Old World Bronze	1
B07136	B07137	Polished Brass	1

Standard Two-Hole Schedule 40 Friction Lift Half Kit



PVC#	ABS#	FINISH	CTN QTY
B07152	B07153	Chrome Plated	1
B0715AL	B0815AL	Almond	1
B0715AB	B0815AB	Antique Brass	1
B0715AN	B0815AN	Antique Nickel	1
B0715BI	B0815BI	Biscuit	1
B0715BL	B0815BL	Black	1
B0715BN	B0815BN	Brushed Nickel	1
B0715NP	B0815NP	Pearl Nickel	1
B0715PN	B0815PN	Polished Nickel	1
B0715PS	B0815PS	Polished Stainless	1
B0715PW	B0815PW	Polar White	1
B0715RB	B0815RB	Oil Rubbed Bronze	1
B0715WB	B0815WB	Old World Bronze	1
B07154	B07155	Polished Brass	1

Tubular Lift and Turn Full Kit



PVC#	ABS#	FINISH	CTN QTY
P37500	P39500	Chrome Plated	1
P3750AB	P3950AB	Antique Brass	1
P3750AL	P3950AL	Almond	1
P3750AN	P3950AN	Antique Nickel	1
P3750BI	P3950BI	Biscuit	1
P3750BL	P3950BL	Black	1
P3750BN	P3950BN	Brushed Nickel	1
P3750BS	P3950BS	Brushed Stainless	1
P3750NP	P3950NP	Pearl Nickel	1
P3750PN	P3950PN	Polished Nickel	1
P3750PS	P3950PS	Polished Stainless	1
P3750PW	P3950PW	Polar White	1
P3750RB	P3950RB	Oil Rubbed Bronze	1
P3750WB	P3950WB	Old World Bronze	1
P37501	P39501	Polished Brass	1
P37502	P39502	Satin Nickel	1

Tubular Friction Lift Full Kit



PVC#	ABS#	FINISH	CTN QTY
P37503	P39503	Chrome Plated	1
P3751AB	P3951AB	Antique Brass	1
P3751AL	P3951AL	Almond	1
P3751AN	P3951AN	Antique Nickel	1
P3751BI	P3951BI	Biscuit	1
P3751BL	P3951BL	Black	1
P3751BN	P3951BN	Brushed Nickel	1
P3751BS	P3951BS	Brushed Stainless	1
P3751NP	P3951NP	Pearl Nickel	1
P3751PN	P3951PN	Polished Nickel	1
P3751PS	P3951PS	Polished Stainless	1
P3751PW	P3951PW	Polar White	1
P3751RB	P3951RB	Oil Rubbed Bronze	1
P3751WB	P3951WB	Old World Bronze	1
P37504	P39504	Polished Brass	1
P37505	P39505	Satin Nickel	1

Tubular Toe Touch Kit



PVC#	ABS#	FINISH	CTN QTY
P37506	P39506	Chrome Plated	1
P3752AB	P3952AB	Antique Brass	1
P3752AL	P3952AL	Almond	1
P3752AN	P3952AN	Antique Nickel	1
P3752BI	P3952BI	Biscuit	1
P3752BL	P3952BL	Black	1
P3752BN	P3952BN	Brushed Nickel	1
P3752NP	P3952NP	Pearl Nickel	1
P3752PN	P3952PN	Polished Nickel	1
P3752PS	P3952PS	Polished Stainless	1
P3752PW	P3952PW	Polar White	1
P3752RB	P3952RB	Oil Rubbed Bronze	1
P3752WB	P3952WB	Old World Bronze	1
P37507	P39507	Polished Brass	1
P37508	P39508	Satin Nickel	1

27" Cable Drive Full Kit

1-1/2" Schedule 40 Cable Drive



PART NO.	FINISH	CTN QTY
P37550	Chrome Plated	1
P3755BN	Brushed Nickel	1
P3755NP	Pearl Nickel	1
P3755PB	Polished Brass	1
P3755RB	Oil Rubbed Bronze	1
P3755SC	Satin Chrome	1
P3755WB	Old World Bronze	1
P3755WH	White	1

Tubular Trip Lever Kit



PVC#	ABS#	FINISH	CTN QTY
P37509	P39509	Chrome Plated	1
P3761AB	P3961AB	Antique Brass	1
P3761AL	P3961AL	Almond	1
P3761AN	P3961AN	Antique Nickel	1
P3761BI	P3961BI	Biscuit	1
P3761BL	P3961BL	Black	1
P3761BN	P3961BN	Brushed Nickel	1
P3761BS	P3961BS	Brushed Stainless	1
P3761NP	P3961NP	Pearl Nickel	1
P3761PN	P3961PN	Polished Nickel	1
P3761PS	P3961PS	Polished Stainless	1
P3761PW	P3961PW	Polar White	1
P3761RB	P3961RB	Oil Rubbed Bronze	1
P3761WB	P3961WB	Old World Bronze	1
P37510	P39510	Polished Brass	1
P37511	P39511	Satin Nickel	1

4-1/4" Stamped Strainers



- For D50001 tile shower drain
- Blister packaging

PART NO.	FINISH	CTN QTY
C60806	Chrome Plated	1
C6089AB	Antique Brass	1
C6089AL	Almond	1
C6089AN	Antique Nickel	1
C6089BI	Biscuit	1
C6089BL	Black	1
C6089BN	Brushed Nickel	1
C6089NP	Pearl Nickel	1
C6089PN	Polished Nickel	1
C6089PS	Polished Stainless	1
C6089PW	Polar White	1
C6089RB	Oil Rubbed Bronze	1
C6089WB	Old World Bronze	1

Snap-in Strainers



- For no caulk fiberglass shower stalls
- Fits D40101, D40140 and D50001
- Blister packaging

PART NO.	FINISH	CTN QTY
D40005	Chrome Plated	1
D4005BN	Brushed Nickel	1
D4005NP	Pearl Nickel	1
D4005RB	Oil Rubbed Bronze	1
D4005WB	Old World Bronze	1

4-1/4" Round Cast Brass Heavy Duty Strainers



- Fits D50001

PART NO.	FINISH	CTN QTY
C6087BN	Brushed Nickel	1
C6087NP	Pearl Nickel	1
C6087RB	Oil Rubbed Bronze	1
C6087WB	Old World Bronze	1

4-1/4" Square Cast Brass Heavy Duty Strainers



- Fits D50001

PART NO.	FINISH	CTN QTY
C6083BN	Brushed Nickel	1
C6083NP	Pearl Nickel	1
C6083RB	Oil Rubbed Bronze	1
C6083WB	Old World Bronze	1

5.196" Round Cast Brass Heavy Duty Strainers



- Fits light duty commercial drains

PART NO.	FINISH	CTN QTY
C6084BN	Brushed Nickel	1
C6084NP	Pearl Nickel	1
C6084RB	Oil Rubbed Bronze	1
C6084WB	Old World Bronze	1

4-1/4" Strainer w/Screws for Fiberglass Shower Stalls



- Fits D41001 and D41600
- Tapping screws included
- Blister card packaging

PART NO.	FINISH	CTN QTY
D41101	Stainless Steel	1
D4110BN	Brushed Nickel	1
D4110NP	Pearl Nickel	1
D4110RB	Oil Rubbed Bronze	1
D4110WB	Old World Bronze	1

Shower Drain Strainers

Carded w/Screws



PART NO.	DESCRIPTION	STR.	CTN QTY
D54010	4" PB Stamped to fit inside plastic ring	PVD	10



PART NO.	DESCRIPTION	STR.	CTN QTY
C60810	4-1/4" PB stamped coverall	PVD	10



PART NO.	DESCRIPTION	STR.	CTN QTY
C60813	4-1/4" PB cast square	PVD	10



PART NO.	DESCRIPTION	STR.	CTN QTY
C60807	4-1/4" PB cast coverall	PVD	10



PART NO.	DESCRIPTION	STR.	CTN QTY
C60814	4-1/4" SN cast coverall	PVD	1

Snap-in Strainers Carded



PART NO.	DESCRIPTION	STR.	CTN QTY
D40003	4-1/4" Snap-in	PB-PVD	5
D40004	4-1/4" Snap-in	White	1
D40010	4-1/4" Snap-in	SN	1

Screw-Down Strainers Carded



PART NO.	DESCRIPTION	STR.	CTN QTY
D41102	4-1/4" w/screws	PB-PVD	10
D41107	4-1/4" w/screws	SN	1

DRAIN REFERENCE CHART			
D54010 D50 series	C60810 D50 series D54 series	C60813 D50 series D53 series	C60807 D50 series D53 series
C60814 D50 series	D40003 D40101 series D40140 series	D40004 D40151 series D40401 series D40440 series	D40010 D40101 series D40140 series D41007 series
D41102 D41001 series		D41107 D41001 series	

3-1/2" PVC Spud w/5" Round Str.



PART NO.	FINISH	CTN QTY
D56211	Stainless Steel	1
D56212	Polished Brass	1
D56214	Old World Bronze	1
D56216	Chrome Plated	1
D6084BN	Brushed Nickel	1
D6084NP	Pearl Nickel	1
D6084RB	Oil Rubbed Bronze	1
D6084WB	Old World Bronze	1

3-1/2" Metal Spud w/5" Round Str.



• All brass

PART NO.	FINISH	CTN QTY
D60990	Chrome Plated	1
D60991	Polished Brass	1
D60996	Nickel Bronze	1
D6091BN	Brushed Nickel	1
D6091NP	Pearl Nickel	1
D6091RB	Oil Rubbed Bronze	1
D6091WB	Old World Bronze	1

2" Metal Spud w/ 4-1/4" Round Str.



• All brass

PART NO.	FINISH	CTN QTY
D60980	Stainless Steel	1
D60981	Chrome Plated	1
D60982	Polished Brass	1
D6098BN	Brushed Nickel	1
D6098NP	Pearl Nickel	1
D6098RB	Oil Rubbed Bronze	1
D6098WB	Old World Bronze	1

3-1/2" Metal Spud w/5" Square Str.



• All brass

PART NO.	FINISH	CTN QTY
D60954	Chrome Plated	1
D60962	Nickel Bronze	1
D60960	Polished Brass	1
D6096BN	Brushed Nickel	1
D6096NP	Pearl Nickel	1
D6096RB	Oil Rubbed Bronze	1
D6096WB	Old World Bronze	1

2" Brass Spud w/4" Square Strainer



- All brass

PART NO.	FINISH	CTN QTY
D60942	Chrome Plated	1
D6094BN	Brushed Nickel	1
D6094NP	Pearl Nickel	1
D6094PB	Polished Brass	1
D6094RB	Oil Rubbed Bronze	1
D6094WB	Old World Bronze	1

2" x 3" Heavy Duty Shower Drain w/3-1/2" Spud & 5" Strainer



- PVC spud
- Round strainer
- For multi-head showers

PART NO.	FINISH	CTN QTY
D49059	Chrome Plated	1
D49057	Nickel Bronze	1
D49055	Polished Brass	1
D4912BN	Brushed Nickel	1
D4912NP	Pearl Nickel	1
D4912RB	Oil Rubbed Bronze	1
D4912WB	Old World Bronze	1

3" x 4" Heavy Duty Shower Drain w/3-1/2" Spud & 5" Strainer



- Metal spud
- Round strainer
- For multi-head showers

PART NO.	FINISH	CTN QTY
D49159	Chrome Plated	1
D49157	Nickel Bronze	1
D49155	Polished Brass	1
D4991BN	Brushed Nickel	1
D4991NP	Pearl Nickel	1
D4991RB	Oil Rubbed Bronze	1
D4991WB	Old World Bronze	1

3" x 4" Heavy Duty PVC Shower Drain w/3-1/2" Spud & 5" Square Strainer



- Metal spud
- Square strainer
- For multi-head showers

PART NO.	FINISH	CTN QTY
D4996BN	Brushed Nickel	1
D4996NP	Pearl Nickel	1
D4996RB	Oil Rubbed Bronze	1
D4996WB	Old World Bronze	1

3"x4" HD PVC Shower Drain w/3-1/2" Plastic Spud & 5" Round Strainer



- PVC spud
- Round strainer
- For multi-head showers

PART NO.	FINISH	CTN QTY
D4984BN	Brushed Nickel	1
D4984NP	Pearl Nickel	1
D4984RB	Oil Rubbed Bronze	1
D4984WB	Old World Bronze	1

2" x 3" Shower Drain w/2" Spud & 4-1/4" Strainer



PART NO.	FINISH	CTN QTY
D5001BN	Brushed Nickel	1
D5001NP	Pearl Nickel	1
D5001RB	Oil Rubbed Bronze	1
D5001WB	Old World Bronze	1

Ultrafit Tank Lever - Replaces 96% of All Tank Levers



- PATENTED
- New shapable arm bends to fit the needed arm angle
- Arm can be cut to fit 4", 6" or 8" lengths for customized fit
- Heavy duty plastic handle comes in a variety of finishes
- Sturdy plastic arm, spud and nut
- Blister card packaging

PART NO.	FINISH	CTN QTY
T01100	Chrome Plated	25
T01101	Polished Brass	25
T01102	White	1
T01103	Bone	1
T04001	Display - Includes 12 each of above	1

Decorative Tank Trip Levers

Fit-All Decorative Tank Trip Levers



• 8" arm

PART NO.	FINISH	DESCRIPTION	CTN QTY
T01003	PB Metal	Brass arm with metal spud and nut	25
T01004	AB Metal	Brass plated arm with metal spud and nut	25
T01007	Satin Nickel	Brass arm with metal spud and nut	1



• 8" arm

PART NO.	FINISH	DESCRIPTION	CTN QTY
T01061	PB Metal	Brass plated arm with plastic spud & nut / universal fit	25



• 8" arm

PART NO.	FINISH	DESCRIPTION	CTN QTY
T01063	PB ABS	Plastic arm, spud & nut universal fit	25

Fit-All Heavy Duty Decorative Tank Trip Levers



• 8" arm

PART NO.	FINISH	DESCRIPTION	CTN QTY
T01006	PB Metal	Brass arm with metal spud and nut / universal fit	25
T01008	Satin Nickel	Brass arm with die cast nut	1

Fit-All Decorative Tank Trip Levers



• 8" arm

PART NO.	FINISH	DESCRIPTION	CTN QTY
T01071	PB ABS	Side mount push button brass arm with plastic spud and nut	6
T01075	PV ABS	Front mount push button brass arm with plastic spud and nut	6

Decorative Tank Trip Levers for American Standard



• 9-1/2" arm

PART NO.	FINISH	DESCRIPTION	CTN QTY
T01065	PB Metal	Brass arm with metal spud and nut. Offset for thick tank walls	25



• 8" arm

PART NO.	FINISH	DESCRIPTION	CTN QTY
T01049	PB ABS	Neo 28° combo with plastic arm, spud and nut	1



• 6" arm

PART NO.	FINISH	DESCRIPTION	CTN QTY
T01043	PB ABS	45° arm for Cadet 2* plastic arm, spud and nut	25
T01044	White ABS	45° arm with Cadet 2* plastic arm, spud and nut	25
T01045	Bone ABS	45° arm with Cadet 2* plastic arm, spud and nut	25



• 4" arm

PART NO.	FINISH	DESCRIPTION	CTN QTY
T01031	PB ABS	Plastic arm, spud and nut for beaded chain	25
T01032	White ABS	Plastic arm, spud and nut for beaded chain	25
T01033	Bone ABS	Plastic arm, spud and nut for beaded chain	25



• 6" arm

PART NO.	FINISH	DESCRIPTION	CTN QTY
T01051	PB ABS	Plastic arm, spud and nut for Plebe* and Cadet*	25
T01052	White ABS	Plastic arm, spud and nut for Plabe* and Cadet*	25
T01053	Bone ABS	Plastic arm, spud and nut for Pleve* and Cadet*	25

Crane



• 8" arm

PART NO.	FINISH	DESCRIPTION	CTN QTY
T01035	PB ABS	Plastic arm, spud and nut	25
T01036	White ABS	Plastic arm, spud and nut	25
T01037	Bone ABS	Plastic arm, spud and nut	25

Decorative Tank Trip Levers for Eljer



• 9" arm

PART NO.	FINISH	DESCRIPTION	CTN QTY
T01021	PB Metal	Side mount / Brass arm with non-crack nylon spud and nut	25

Decorative Tank Trip Levers for Kohler



• 8" arm

PART NO.	FINISH	DESCRIPTION	CTN QTY
T01017	PB Metal	Wellworth/Barrington Lite new style / side mount 1.6 gal. unit replacement plastic arm spud and nut	6
T01015	PB Metal	Cast brass arm with metal spud & nut	6

Decorative Tank Trip Levers for Mansfield



• 9" arm

PART NO.	FINISH	DESCRIPTION	CTN QTY
T01073	PB ABS	#41* plastic arm, spud and nut	25

Decorative Tank Trip Levers for Universal Rundle/Sears



• 8" arm

PART NO.	FINISH	DESCRIPTION	CTN QTY
T01067	PB Metal	Brass arm with plastic spud and nut fits Universal Rundle/Sears*	25

Universal Decorative Closet Flush Lever



• Brass handle and arm
• 8" arm

PART NO.	FINISH	CTN QTY
T01000	Chrome Plated	1
T0100BN	Brushed Nickel	1
T0100NP	Pearl Nickel	1
T0100PB	Polished Brass	1
T0100RB	Oil Rubbed Bronze	1
T0100WB	Old World Bronze	1

Eljer Side Mount Tank Lever



• 8" Brass arm

PART NO.	FINISH	CTN QTY
T0102BN	Brushed Nickel	1
T0102NP	Pearl Nickel	1
T0102RB	Oil Rubbed Bronze	1
T0102WB	Old World Bronze	1

Universal Front or Side Mount Tank Lever



• Can be used as a front mount or side mount
• 8" Adjustable arm

PART NO.	FINISH	CTN QTY
T01330	Chrome	1
T0133BN	Brushed Nickel	1
T0133NP	Pearl Nickel	1
T0133RB	Oil Rubbed Bronze	1
T0133WB	Old World Bronze	1

Kohler Side Mount Tank Lever



• 8" Brass arm

PART NO.	FINISH	CTN QTY
T0108BN	Brushed Nickel	1
T0108NP	Pearl Nickel	1
T0108RB	Oil Rubbed Bronze	1
T0108WB	Old World Bronze	1
T01181	Polished Brass	1

A
 Aerator 6

B
 Bar Sink 7
 Bar Tap Faucet..... 3
 Basket Strainers 2
 Bath Drains 17, 18
 Bath Waste Conversion Kits 15
 Bathwaste Full Kits..... 19, 20, 21, 22
 Bathwaste Half Kits..... 19, 20, 21
 Brass Nipples..... 6

C
 Ceiling Plates..... 6
 Celcon Basket Strainers..... 1
 Closet Supply And Stop Kit..... 8
 Cock Hole Cover 4
 Contoured Shower Curtain Rods..... 13
 Conversion Kits..... 16

D
 Decorative Air Gap..... 4
 Decorative Hose And Spray 4
 Dispenser Faucet..... 3
 Disposal Assembly 1
 Diverter Spouts..... 10

E
 Escutcheons 5

F
 Faceplate 17
 Faceplate And Screws..... 16
 Faceplate Screws..... 17
 Faucet Handles 6
 Faucet Hole Cover..... 3, 4
 Flip-It Conversion Kit..... 17
 Flip-It Tub Stopper 17
 Floor Plates 6

G
 Garbage Disposal..... 1
 Garbage Disposal Flange Stopper
 And Strainer Combination 1

H
 Handicap Faucet Handles 6

L
 Lavatory Supply And Stop Kit 9
 Lav Drain 11
 Lotion And Soap Dispenser 3

O
 Overflow Plates 15

P
 Pop-Up Assembly..... 11
 P-Trap 6, 11

R
 Replacement Basket Strainers 2

S
 Shower Arm 11, 12
 Shower Arm Flange..... 13
 Shower Curtain Rod 13
 Shower Drains 25
 Shower Head..... 13, 14
 Sleeves..... 7
 Stop With 5" Sweat Extension And Escutcheon..... 7

Strainers 23, 24
 Supply Stops..... 7, 8
 Supply Tubes 9

T
 Trip Levers..... 26, 27
 Tub Spouts..... 10

PART NO.	PG #
A01019	6
A10001	4
A10002	4
A10003	4
A10004	4
A10005	4
A10006	4
A10010	4
A10011	4
A10015	4
A10016	4
A10017	4
A10018	4
A10019	4
B02001	1
B02001B	1
B02002	1
B02002B	1
B02003	1
B02003B	1
B02004	1
B02004B	1
B02005	1
B02005B	1
B02008	2
B02020	2
B02020B	2
B02021	2
B02021B	2
B02022	2
B02022B	2
B02023	2
B02023B	2
B02024	2
B02024B	2
B02050	2
B02100	2
B02101	3
B02102	3
B02301	2
B02302	2
B02303	2
B02304	2
B02305	2
B02400	2
B02401	2
B02402	2
B02404	2
B02405	2
B02406	2
B02407	2
B02408	2
B0250BN	2
B0250NP	2
B0250RB	2
B0250WB	2
B03000	1

PART NO.	PG #
B03001	1
B03001B	1
B03002	1
B03002B	1
B03003	1
B03003B	1
B03004	1
B03004B	1
B03005	1
B03005B	1
B03021	1
B03021B	1
B03022	1
B03022B	1
B03023	1
B03023B	1
B03024	1
B03024B	1
B03025	1
B03025B	1
B03031	1
B03032	1
B03033	1
B03034	1
B03035	1
B03400	1
B03401	1
B03402	1
B03405	1
B03406	1
B03407	1
B03408	1
B07010	19
B07011	19
B07012	19
B07013	19
B07014	19
B07015	19
B07016	19
B07017	19
B07030	19
B07031	19
B07032	20
B07033	20
B07034	19
B07035	19
B07036	20
B07037	20
B07052	19
B07053	19
B07054	19
B07055	19
B07058	19
B07059	19
B07060	19
B07061	19
B07110	20

PART NO.	PG #
B07111	20
B07112	20
B07113	20
B07114	20
B07115	20
B07116	20
B07117	20
B0711AB	20
B0711AL	20
B0711AN	20
B0711BI	20
B0711BL	20
B0711BN	20
B0711BS	20
B0711NP	20
B0711PN	20
B0711PS	20
B0711PW	20
B0711RB	20
B0711WB	20
B07130	20
B07131	20
B07132	21
B07133	21
B07134	20
B07135	20
B07136	21
B07137	21
B0713AB	20
B0713AL	20
B0713AN	20
B0713BI	20
B0713BL	20
B0713BN	20
B0713NP	20
B0713PN	20
B0713PS	20
B0713PW	20
B0713RB	20
B0713WB	20
B07152	21
B07153	21
B07154	21
B07155	21
B07158	21
B07159	21
B0715AB	21
B0715AL	21
B0715AN	21
B0715BI	21
B0715BL	21
B0715BN	21
B0715NP	21
B0715PN	21
B0715PS	21
B0715PW	21
B0715RB	21

PART NO.	PG #
B0715WB	21
B07160	21
B07161	21
B0716AB	21
B0716AL	21
B0716AN	21
B0716BI	21
B0716BL	21
B0716BN	21
B0716BS	21
B0716NP	21
B0716PN	21
B0716PS	21
B0716PW	21
B0716RB	21
B0716WB	21
B0717AB	20
B0717AL	20
B0717AN	20
B0717BI	20
B0717BL	20
B0717BN	20
B0717BS	20
B0717NP	20
B0717PN	20
B0717PS	20
B0717PW	20
B0717RB	20
B0717WB	20
B0718AB	21
B0718AN	21
B0718BI	21
B0718BL	21
B0718BN	21
B0718NP	21
B0718PN	21
B0718PS	21
B0718PW	21
B0718RB	21
B0718WB	21
B0750BN	19
B0750NP	19
B0750RB	19
B0750WB	19
B0751BN	19
B0751NP	19
B0751RB	19
B0751WB	19
B0752BN	19
B0752NP	19
B0752RB	19
B0752WB	19
B0753BN	19
B0753NP	19
B0753RB	19
B0753WB	19
B0754BN	19

PART NO.	PG #
B0754NP	19
B0754RB	19
B0754WB	19
B0755BN	20
B0755NP	20
B0755RB	20
B0755WB	20
B0811AB	20
B0811AL	20
B0811AN	20
B0811BI	20
B0811BL	20
B0811BN	20
B0811BS	20
B0811NP	20
B0811PN	20
B0811PS	20
B0811PW	20
B0811RB	20
B0811WB	20
B0813AB	20
B0813AL	20
B0813AN	20
B0813BI	20
B0813BL	20
B0813BN	20
B0813NP	20
B0813PN	20
B0813PS	20
B0813PW	20
B0813RB	20
B0813WB	20
B0815AB	21
B0815AL	21
B0815AN	21
B0815BI	21
B0815BL	21
B0815BN	21
B0815NP	21
B0815PN	21
B0815PS	21
B0815PW	21
B0815RB	21
B0815WB	21
B0816AB	21
B0816AL	21
B0816AN	21
B0816BI	21
B0816BL	21
B0816BN	21
B0816BS	21
B0816NP	21
B0816PN	21
B0816PS	21
B0816PW	21
B0816RB	21
B0816WB	21

PART NO.	PG #
B0817AB	20
B0817AL	20
B0817AN	20
B0817BI	20
B0817BL	20
B0817BN	20
B0817BS	20
B0817NP	20
B0817PN	20
B0817PS	20
B0817PW	20
B0817RB	20
B0817WB	20
B0818AB	21
B0818AN	21
B0818BI	21
B0818BL	21
B0818BN	21
B0818NP	21
B0818PN	21
B0818PS	21
B0818PW	21
B0818RB	21
B0818WB	21
B0850BN	19
B0850NP	19
B0850RB	19
B0850WB	19
B0851BN	19
B0851NP	19
B0851RB	19
B0851WB	19
B0852BN	19
B0852NP	19
B0852RB	19
B0852WB	19
B0853BN	19
B0853NP	19
B0853RB	19
B0853WB	19
B0854BN	19
B0854NP	19
B0854RB	19
B0854WB	19
B0855BN	20
B0855NP	20
B0855RB	20
B0855WB	20
B1020AL	4
B1020AN	4
B1020BI	4
B1020BL	4
B1020BN	4
B1020NP	4
B1020PN	4
B1020PS	4
B1020PW	4

PART NO.	PG #
B1020RB	4
B1020WB	4
B45010	3
B51001	15
B51002	15
B51003	15
B51004	16
B51005	16
B51007	16
B51010	15
B51014	16
B51015	16
B51019	15
B51020	15
B5112AP	16
B5112BB	16
B5112BI	16
B5112BN	16
B5112BS	16
B5112NP	16
B5112PW	16
B5112RB	16
B5112WB	16
B5114AP	16
B5114BB	16
B5114BN	16
B5114NP	16
B5114PB	16
B5114PN	16
B5114PS	16
B5114RB	16
B5114WB	16
B5155AB	16
B5155AL	16
B5155AN	16
B5155AP	16
B5155BB	16
B5155BI	16
B5155BL	16
B5155BN	16
B5155BS	16
B5155NP	16
B5155PS	16
B5155PW	16
B5155RB	16
B5155WB	16
B5156AP	16
B5156BB	16
B5156BN	16
B5156NP	16
B5156PS	16
B5156RB	16
B5156WB	16
B5160AP	15
B5160BB	15
B5160BN	15
B5160BS	15

PART NO.	PG #
B5160NP	15
B5160PN	15
B5160PS	15
B5160RB	15
B5160WB	15
B5161AP	15
B5161BB	15
B5161BN	15
B5161NP	15
B5161PS	15
B5161RB	15
B5161WB	15
B70001	3
B70003	3
B70004	3
B70006	3
B70007	3
B70008	3
B70009	3
B70010	3
B70011	3
B70012	3
B70013	3
B70014	3
B70017	3
B70018	3
B70019	3
B70020	3
BO718AL	21
C06001	3
C06002	3
C06004	4
C06005	4
C06006	4
C06007	4
C06008	4
C06011	4
C06012	4
C06013	4
C06014	4
C06016	4
C06017	4
C06018	4
C06020	4
C06021	4
C06022	4
C06024	4
C60806	23
C60807	24
C60810	24
C60813	24
C60814	24
C6083BN	23
C6083NP	23
C6083RB	23
C6083WB	23
C6084BN	23

PART NO.	PG #
C6084NP	23
C6084RB	23
C6084WB	23
C6087BN	23
C6087NP	23
C6087RB	23
C6087WB	23
C6089AB	23
C6089AL	23
C6089AN	23
C6089BI	23
C6089BL	23
C6089BN	23
C6089NP	23
C6089PN	23
C6089PS	23
C6089PW	23
C6089RB	23
C6089WB	23
D01032	10
D03001	10
D03002	10
D03004	10
D03010	10
D03011	10
D03015	10
D03016	10
D03020	10
D07005	3
D07008	3
D40003	24
D40004	24
D40005	23
D40010	24
D4005BN	23
D4005NP	23
D4005RB	23
D4005WB	23
D41101	23
D41102	24
D41107	24
D4110BN	23
D4110NP	23
D4110RB	23
D4110WB	23
D49055	25
D49057	25
D49059	25
D4912BN	25
D4912NP	25
D4912RB	25
D4912WB	25
D49155	25
D49157	25
D49159	25
D4984BN	25
D4984NP	25

PART NO.	PG #
D4984RB	25
D4984WB	25
D4991BN	25
D4991NP	25
D4991RB	25
D4991WB	25
D4996BN	25
D4996NP	25
D4996RB	25
D4996WB	25
D5001BN	25
D5001NP	25
D5001RB	25
D5001WB	25
D54010	24
D56211	24
D56212	24
D56214	24
D56216	24
D6084BN	24
D6084NP	24
D6084RB	24
D6084WB	24
D6091BN	24
D6091NP	24
D6091RB	24
D6091WB	24
D60942	25
D6094BN	25
D6094NP	25
D6094PB	25
D6094RB	25
D6094WB	25
D60954	24
D60960	24
D60962	24
D6096BN	24
D6096NP	24
D6096RB	24
D6096WB	24
D60980	24
D60981	24
D60982	24
D6098BN	24
D6098NP	24
D6098RB	24
D6098WB	24
D60990	24
D60991	24
D60996	24
D70105	11
D7010BN	11
D7010NP	11
D7010PB	11
D7010RB	11
D7010WB	11
E01050	5

PART NO.	PG #
E0105BN	5
E0105NP	5
E0105RB	5
E0105WB	5
E02050	5
E0205BN	5
E0205NP	5
E0205RB	5
E0205WB	5
E0412BN	5
E0412NP	5
E0412RB	5
E0412WB	5
E04125	5
E04150	5
E0415BN	5
E0415NP	5
E0415RB	5
E0415WB	5
E06050	5
E0605BN	5
E0605NP	5
E0605PB	5
E0605RB	5
E0605WB	5
E07050	5
E0705BN	5
E0705NP	5
E0705PB	5
E0705RB	5
E0705WB	5
E08125	5
E0812BN	5
E0812NP	5
E0812PB	5
E0812RB	5
E0812WB	5
E08150	5
E0815BN	5
E0815NP	5
E0815PB	5
E0815RB	5
E0815WB	5
E80050	5
E80075	5
E81050	5
E81075	5
E81375	5
E82125	5
E82150	5
E83125	5
E83150	5
F05001	1
F08050	6
F08075	6
F08099	6
F08100	6

PART NO.	PG #
F08124	6
F08125	6
F08150	6
F08200	6
F08201	6
F08375	6
H54004	6
H54007	6
H54008	6
K52002	4
K52010	4
K52011	4
K52012	4
K52013	4
K52014	4
K52016	4
K52017	4
N15400	6
N15600	6
N16400	6
N16600	6
N17050	6
N17375	6
N2206BN	6
N2206NP	6
N2206RB	6
N2206WB	6
N2210BN	6
N2210NP	6
N2210PB	6
N2210RB	6
N2210WB	6
N2306BN	6
N2306NP	6
N2306RB	6
N2306WB	6
N2310BN	6
N2310NP	6
N2310PB	6
N2310WB	6
P35001	11
P35002	11
P35003	11
P3500BN	11
P3500NP	11
P3500PB	11
P3500RB	11
P3500WB	11
P35050	17, 18
P35051	17
P35052	17
P35053	17
P35055	17
P35056	17
P35058	18
P35060	17
P35061	17

PART NO.	PG #
P35062	17
P35062	18
P35063	17
P35065	17
P35066	18
P35067	19
P35068	18, 19
P35070	17
P35071	17
P35072	18
P35073	18
P35170	17
P35171	17
P35172	17
P3560AB	18
P3560AL	18
P3560AN	18
P3560BI	18
P3560BL	18
P3560BN	18
P3560BS	18
P3560NP	18
P3560PN	18
P3560PS	18
P3560PW	18
P3560RB	18
P3560WB	18
P35610	18
P35611, 19	18
P35612	18
P35613	18
P35614	18
P35615	17
P35616	15
P3561AB	19
P3561AL	19
P3561AN	19
P3561BI	19
P3561BL	19
P3561BN	19
P3561BS	19
P3561NP	19
P3561PN	19
P3561PS	19
P3561PW	19
P3561RB	19
P3561WB	19
P3562AB	18
P3562AL	18
P3562AN	18
P3562BI	18
P3562BL	18
P3562BN	18
P3562BS	18
P3562NP	18
P3562PN	18
P3562PS	18

PART NO.	PG #
P3562PW	18
P3562RB	18
P3562WB	18
P3563AB	18
P3563AL	18
P3563AN	18
P3563BI	18
P3563BL	18
P3563BN	18
P3563BS	18
P3563NP	18
P3563PN	18
P3563PS	18
P3563PW	18
P3563RB	18
P3563WB	18
P3565AB	17
P3565AL	17
P3565AN	17
P3565BI	17
P3565BL	17
P3565BN	17
P3565BS	17
P3565NP	17
P3565PN	17
P3565PS	17
P3565PW	17
P3565RB	17
P3565WB	17
P3566AB	16
P3566AL	16
P3566AN	16
P3566BI	16
P3566BL	16
P3566BN	16
P3566BS	16
P3566NP	16
P3566PN	16
P3566PS	16
P3566PW	16
P3566RB	16
P3566WB	16
P35920	11
P35921	11
P35922	11
P36100	6
P36101	6
P36125	11
P36150	11
P37500	21
P37501	21
P37502	21
P37503	22
P37504	22
P37505	22
P37506	22
P37507	22

PART NO.	PG #
P37508	22
P37509	22
P3750AB	21
P3750AL	21
P3750AN	21
P3750BI	21
P3750BL	21
P3750BN	21
P3750BS	21
P3750NP	21
P3750PN	21
P3750PS	21
P3750PW	21
P3750RB	21
P3750WB	21
P37510	22
P37511	22
P3751AB	22
P3751AL	22
P3751AN	22
P3751BI	22
P3751BL	22
P3751BN	22
P3751BS	22
P3751NP	22
P3751PN	22
P3751PS	22
P3751PW	22
P3751RB	22
P3751WB	22
P3752AB	22
P3752AL	22
P3752AN	22
P3752BI	22
P3752BL	22
P3752BN	22
P3752NP	22
P3752PN	22
P3752PS	22
P3752PW	22
P3752RB	22
P3752WB	22
P37550	22
P3755BN	22
P3755NP	22
P3755PB	22
P3755RB	22
P3755SC	22
P3755WB	22
P3755WH	22
P3761AB	22
P3761AL	22
P3761AN	22
P3761BI	22
P3761BL	22
P3761BN	22
P3761BS	22

PART NO.	PG #
P3761NP	22
P3761PN	22
P3761PS	22
P3761PW	22
P3761RB	22
P3761WB	22
P3892BN	11
P3892NP	11
P3892PB	11
P3892RB	11
P3892WB	11
P39500	21
P39501	21
P39502	21
P39503	22
P39504	22
P39505	22
P39506	22
P39507	22
P39508	22
P39509	22
P3950AB	21
P3950AL	21
P3950AN	21
P3950BI	21
P3950BL	21
P3950BN	21
P3950BS	21
P3950NP	21
P3950PN	21
P3950PS	21
P3950PW	21
P3950RB	21
P3950WB	21
P39510	22
P39511	22
P3951AB	22
P3951AL	22
P3951AN	22
P3951BI	22
P3951BL	22
P3951BN	22
P3951BS	22
P3951NP	22
P3951PN	22
P3951PS	22
P3951PW	22
P3951RB	22
P3951WB	22
P3952AB	22
P3952AL	22
P3952AN	22
P3952BI	22
P3952BL	22
P3952BN	22
P3952NP	22
P3952PN	22

PART NO.	PG #	PART NO.	PG #	PART NO.	PG #	PART NO.	PG #
P3952PS	22	S01185	14	S02190	13	S1038NP	8
P3952PW	22	S01186	14	S02191	13	S1038PS	8
P3952RB	22	S01187	14	S02193	13	S1038RB	8
P3952WB	22	S0132BN	12	S02290	13	S1038WB	8
P3961AB	22	S0132NP	12	S02291	13	S14007	2
P3961AL	22	S0132RB	12	S02293	13	S1407BN	2
P3961AN	22	S0132WB	12	S03009	14	S1407NP	2
P3961BI	22	S0151BN	11	S03030	12	S1407RB	2
P3961BL	22	S0151NP	11	S03032	12	S1407WB	2
P3961BN	22	S0151RB	11	S03040	13	S42021	7
P3961BS	22	S0151WB	11	S03051	14	S4202BN	7
P3961NP	22	S0152BN	11	S03151	13	S4202NP	7
P3961PN	22	S0152NP	11	S03152	13	S4202PB	7
P3961PS	22	S0152RB	11	S04020	9	S4202RB	7
P3961PW	22	S0152WB	11	S04022	9	S4202WB	7
P3961RB	22	S0153BN	11	S04027	9	S42031	7
P3961WB	22	S0153NP	11	S04029	9	S4203BN	7
S01010	13	S0153RB	11	S08020	3	S4203NP	7
S0101BN	13	S0153WB	11	S10020	3	S4203PB	7
S0101NP	13	S0155BN	12	S10021	3	S4203RB	7
S0101RB	13	S0155NP	12	S10022	3	S4203WB	7
S0101WB	13	S0155RB	12	S10023	3	S4211BN	8
S01030	12	S0155WB	12	S10024	3	S4211NP	8
S0130BN	12	S0156BN	12	S10025	3	S4211PN	8
S0130NP	12	S0156NP	12	S10203	8	S4211RB	8
S0130RB	12	S0156RB	12	S10206	8	S4211WB	8
S0130WB	12	S0156WB	12	S10210	8	S4213BN	8
S01032	12	S0157BN	12	S10214	8	S4213NP	8
S01036	12	S0157NP	12	S10351	9	S4213PN	8
S01037	12	S0157RB	12	S1035AP	9	S4213RB	8
S01051	11	S0157WB	12	S1035BB	9	S4213WB	8
S01052	11	S0158BN	12	S1035BN	9	S42220	7
S01053	11	S0158NP	12	S1035NP	9	S4222BN	7
S01055	12	S0158RB	12	S1035PS	9	S4222NP	7
S01056	12	S0158WB	12	S1035RB	9	S4222PB	7
S01057	12	S0184BN	14	S1035WB	9	S4222RB	7
S01058	12	S0184NP	14	S10360	9	S4222WB	7
S01082	13	S0184RB	14	S10361	9	S43021	8
S01083	13	S0184WB	14	S1036AP	9	S4302BN	8
S01084	14	S0185BN	14	S1036BB	9	S4302NP	8
S01085	14	S0185NP	14	S1036BN	9	S4302PB	8
S01086	14	S0185RB	14	S1036NP	9	S4302RB	8
S01087	14	S0185WB	14	S1036PS	9	S4302WB	8
S01088	14	S0186BN	14	S1036RB	9	S43031	8
S01089	14	S0186NP	14	S1036WB	9	S4303BN	8
S01090	14	S0186RB	14	S10371	8	S4303NP	8
S01091	14	S0186WB	14	S1037AP	8	S4303PB	8
S01151	11	S0187BN	14	S1037BB	8	S4303RB	8
S01152	11	S0187NP	14	S1037BN	8	S4303WB	8
S01153	11	S0187RB	14	S1037NP	8	S4312BN	8
S01155	12	S0187WB	14	S1037PS	8	S4312NP	8
S01156	12	S0188BN	14	S1037RB	8	S4312PN	8
S01157	12	S0188RB	14	S1037WB	8	S4312RB	8
S01158	12	S0188WB	14	S10381	8	S4312WB	8
S01182	13	S0189BN	14	S1038AP	8	S4314BN	8
S01183	13	S0189RB	14	S1038BB	8	S4314NP	8
S01184	14	S0189WB	14	S1038BN	8	S4314PN	8

PART NO.	PG #
S4314RB	8
S4314WB	8
S44002	9
S44003	9
S44005	9
S4401BN	9
S4401NP	9
S4401RB	9
S4401WB	9
S4402BN	9
S4402NP	9
S4402RB	9
S4402WB	9
S4403BN	9
S4403NP	9
S4403RB	9
S4403WB	9
S4405BN	9
S4405NP	9
S4405RB	9
S4405WB	9
S45001	1
S52001	7
S52002	7
S52003	7
T01000	27
T01003	26
T01004	26
T01006	26
T01007	26
T01008	26
T0100BN	27
T0100NP	27
T0100PB	27
T0100RB	27
T0100WB	27
T01015	27
T01017	27
T01021	27
T0102BN	27
T0102NP	27
T0102RB	27
T0102WB	27
T01031	26
T01032	26
T01033	26
T01035	26
T01036	26
T01037	26
T01043	26
T01044	26
T01045	26
T01049	26
T01051	26
T01052	26
T01053	26
T01061	26

PART NO.	PG #
T01063	26
T01065	26
T01067	27
T01071	26
T01073	27
T01075	26
T0108BN	27
T0108NP	27
T0108RB	27
T0108WB	27
T01100	26
T01101	26
T01102	26
T01103	26
T01181	27
T01330	27
T0133BN	27
T0133NP	27
T0133RB	27
T0133WB	27
T04001	26
T05002	16
T05003	15
T05011	17
T05012	15
T05013	16
T05015	15
T05021	17
T05024	17
T0521AB	17
T0521AL	17
T0521AN	17
T0521BI	17
T0521BL	17
T0521BN	17
T0521BS	17
T0521NP	17
T0521PN	17
T0521PS	17
T0521PW	17
T0521RB	17
T0521WB	17
T08003	15
T08004	15
T08012	15
T08013	15
T08021	17
T08112	15
T08113	15
T0812BN	15
T0812NP	15
T0812RB	15
T0812WB	15
T0813BN	16
T0813NP	16
T0813PW	16
T0813RB	16

PART NO.	PG #
T0813WB	16
T73300	7
T7330BN	7
T7330NP	7
T7330PB	7
T7330RB	7
T7330WB	7



SECTION B - SPECIALTIES & REPAIR

VOLUME V



Quality
Products *for*
the Plumbing
Professional

Toilet Repairs 1-13

Kitchen & Bath 14-42

Plumbing Connectors/Supply Stops 43-46

Drinking Fountain Bubbler/Sink Faucets & Accessories 47-48

Gas Connectors 49-58

Product Index..... 59-63

Part Number Index..... 64-74

TANK LEVER TO TANK REFERENCE CHART

MFR.	PART NO.	FINISH	SECTION PAGE NO.	TANK STYLE
American Standard*	T01030	CP ABS	B2	Glenwall with vent #4049.177 Compack with vent #4052.346 Norwall with vent #4041.091
	T01031	PB ABS	DECORATIVE (SECT. A)	
	T01032 T01033	White ABS Bone ABS		
	T01042	CPS ABS	B2	Cadet II #4072 Cadet #4029 Cadet II #4014 Ellisse #4075 High Hamilton - 1 pc. #2096 Hamilton - 1 pc. #2092
	T01043	PB ABS	DECORATIVE (SECT. A)	Carlyle #2010.031 New Cadet line
	T01044	White ABS		
	T01045	Bone ABS		
	T01048	CPS ABS	B2	Glenwall #2093 Cadet #2108 Cadet #2109 Cadet #2120 Cadet #2124 Plebe #2131 Plebe #2138 Plebe #2139 Plebe Aquameter
	T01049	PB ABS	DECORATIVE (SECT. A)	
	T01050	CPS ABS	B2	
	T01051	PB ABS	DECORATIVE (SECT. A)	Old style, thick walled
	T01052	White ABS		
	T01053	Bone ABS		
	T01064	CP Metal	B2	
	T01065	PB Metal	DECORATIVE (SECT. A)	
Crane*	T01034	CPS ABS	B2	Galaxy New Galaxy Sante Fe Avon Antigua
Eljer*	T01020	CP Metal	B3	New Emblem
	T01021	PB Metal	DECORATIVE (SECT. A)	
Kohler*	T01010	CP Metal	B3	Wellworth*/Barrington* - Old Style
	T01012	CP Metal	B3	Kohler 9400
	T01015	PB Metal	DECORATIVE (SECT. A)	
	T01016	CP Metal	B3	Wellworth*/Barrington Lite* - Old Style
	T01017	PB Metal	DECORATIVE (SECT. A)	
Mansfield*	T01040	CPS ABS	B3	Mansfield #35 Mansfield #51 Mansfield #8 Mansfield #16 Mansfield #35LT
	T01073	PB ABS	DECORATIVE (SECT. A)	
	T01072	CP Metal	B3	Mansfield old style #42
	T01041	PB Metal	DECORATIVE (SECT. A)	
Universal Rundle*/Sears*	T01066	CP Metal	B3	Saturn 4012 Low Boy 4445
	T01067	PB Metal	DECORATIVE (SECT. A)	

*The manufacturers' names are used only to describe whose products the tank levers will fit. The tank levers are not manufactured by those companies.

Fit-All Tank Trip Lever



PART NO.	FINISH	DESCRIPTION	CTN QTY
T01001	CP Metal	Brass arm with Metal spud and nut	25
T01002	CP Metal	Brass plated arm with Metal spud and nut	25
T01200	CP Metal	Aluminum arm with Zinc spud and nut	25
T01201	CP Metal	Aluminum arm with Plastic spud and nut	25
T01099	Brass	Replacement spud nut	25

Fit-All Economy Tank Trip Lever

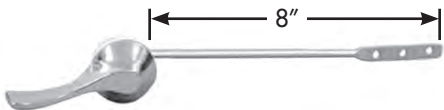

PART NO.	FINISH	DESCRIPTION	CTN QTY
T01060	CP Metal	Brass plated arm with Plastic spud & nut/ Universal fit	25

Fit-All Tank Trip Lever



PART NO.	FINISH	DESCRIPTION	CTN QTY
T01062	CP ABS	Plastic arm, spud & nut Universal fit	25

Fit-All Heavy Duty Tank Trip Lever

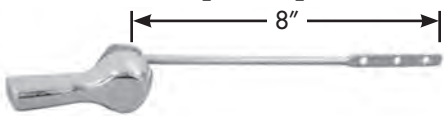

PART NO.	FINISH	DESCRIPTION	CTN QTY
T01005	CP Metal	Brass arm with Metal spud and nut/ Universal fit	25

Fit-All Premium Tank Trip Lever

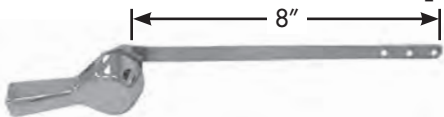

PART NO.	FINISH	DESCRIPTION	CTN QTY
T01068	CP Metal	Flat brass arm with Metal spud and nut	25

Fit-All Side Mount Tank Trip Lever

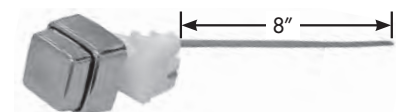

PART NO.	FINISH	DESCRIPTION	CTN QTY
T01070	CP ABS	Side Mount push button Brass arm with Plastic spud and nut	6

Fit-All Front Mount Tank Trip Lever

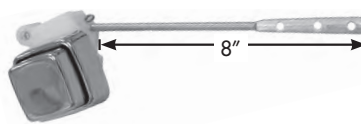

PART NO.	FINISH	DESCRIPTION	CTN QTY
T01074	CP ABS	Front Mount push button Brass arm with Plastic spud and nut	6

American Standard* Tank Trip Lever



PART NO.	FINISH	DESCRIPTION	CTN QTY
T01064	CP Metal	Brass arm with Metal spud and nut Offset for thick tank walls	25

* The manufacturers' names are used only to describe whose products the tank levers will fit. The tank levers are not manufactured by those companies.

American Standard* Tank Trip Lever

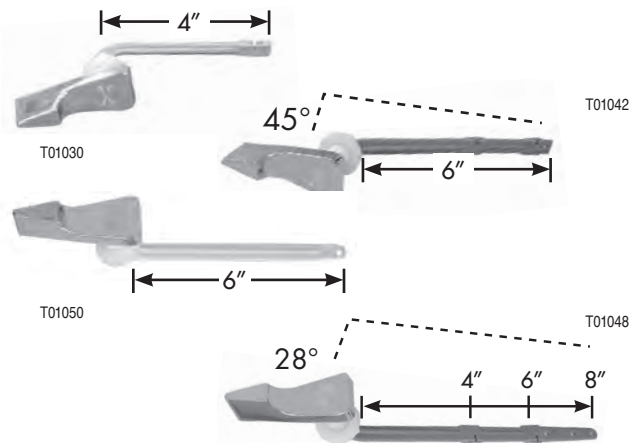

PART NO.	FINISH	DESCRIPTION	CTN QTY
T01030	CP ABS	Plastic arm, spud and nut for beaded chain	25
T01042	CP ABS	45° arm for Cadet 2* Plastic arm, spud and nut	25
T01050	CP ABS	Plastic arm, spud and nut for Plebe* and Cadet*	25
T01048	CP ABS	Neo 28° combo with Plastic arm, spud and nut	25

* The manufacturers' names are used only to describe whose products the tank levers will fit. The tank levers are not manufactured by those companies.

Crane* Tank Trip Lever

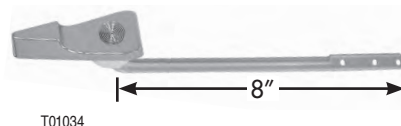

PART NO.	FINISH	DESCRIPTION	CTN QTY
T01034	CP ABS	Plastic arm with Plastic spud and nut	25

* The manufacturers' names are used only to describe whose products the tank levers will fit. The tank levers are not manufactured by those companies.

Eljer* Tank Trip Lever

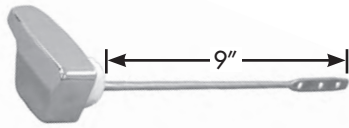

T01020

PART NO.	FINISH	DESCRIPTION	CTN QTY
T01020	CP Metal	Side Mount/Brass arm with Non-crack nylon spud and nut	25

* The manufacturers' names are used only to describe whose products the tank levers will fit. The tank levers are not manufactured by those companies.

Kohler* Tank Trip Lever

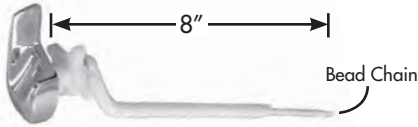

T01010

PART NO.	FINISH	DESCRIPTION	CTN QTY
T01010	CP Metal	Wellworth*/Barrington* Old style/Side mount Plastic arm (less bead hook), spud and nut	5
T01016	CP Metal	Wellworth*/Barrington Lite* New style/Side Mount 1.6 gal. unit replacement Plastic arm, spud and nut	25

* The manufacturers' names are used only to describe whose products the tank levers will fit. The tank levers are not manufactured by those companies.

Kohler* Tank Trip Lever



T01012

PART NO.	FINISH	DESCRIPTION	CTN QTY
T01012	CP Metal	Cast brass arm with Metal spud and nut	1

* The manufacturers' names are used only to describe whose products the tank levers will fit. The tank levers are not manufactured by those companies.

Mansfield* Tank Trip Lever

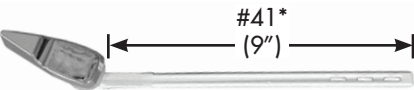

T01040

PART NO.	FINISH	DESCRIPTION	CTN QTY
T01040	CP ABS	#41* Plastic arm, spud and nut	25

* The manufacturers' names are used only to describe whose products the tank levers will fit. The tank levers are not manufactured by those companies.

Mansfield* Tank Trip Lever

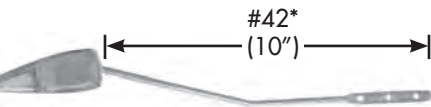

T01072

PART NO.	FINISH	DESCRIPTION	CTN QTY
T01072	CP Metal	#42* Brass arm with plastic spud and nut	25

* The manufacturers' names are used only to describe whose products the tank levers will fit. The tank levers are not manufactured by those companies.

Universal Rundle*/Sears* Tank Trip Lever

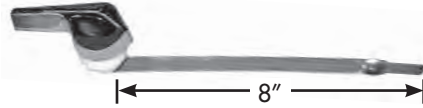

T01066

PART NO.	FINISH	DESCRIPTION	CTN QTY
T01066	CP Metal	Brass arm with Plastic spud and nut Fits Universal Rundle*/Sears*	25

* The manufacturers' names are used only to describe whose products the tank levers will fit. The tank levers are not manufactured by those companies.

Ultrafit Tank Lever



- Bagged
- Patented!
- Heavy Duty plastic arm, spud and nut
- Display Available- Part No. T04-001
- Shapeable arm bends to fit the needed arm angle
- Arm can be cut to 4", 6" or 8" lengths for customized fit
- Fits American Standard, Eljer, Kohler, Mansfield and ToTo

PART NO.	DESCRIPTION	CTN QTY
T01100	CP ABS Ultrafit tank lever	25

Western Pottery Tank Trip Lever



- Side Mount
- 10 inch brass arm
- Plastic spud and nut

PART NO.	DESCRIPTION	CTN QTY
T01080	Western Pottery tank trip lever	25

ToTo Chrome Plated Tank Lever



- Side Mount
- 10 inch brass arm
- Plastic spud and nut

PART NO.	DESCRIPTION	CTN QTY
T01081	ToTo chrome plated tank trip lever	25

Eljer* Touch Flush* Assembly



- CARTON QUANTITIES ONLY
- Complete with tank, lever, chain, ball and arm

PART NO.	DESCRIPTION	CTN QTY
C04019	Touch Flush assembly	5

* The manufacturers' names are used only to describe whose products the products will fit.

Tank Ball and Seat Discs



- CARTON QUANTITIES ONLY
- New boxing to protect shape of units

PART NO.	DESCRIPTION	CTN QTY
C04020	Eljer* tank ball for touch flush	10
C04021	Fit-All tank ball less guide	10
C04030	2 1/4" - 2 5/8" Tri-seal tank ball boxed	12
C04031	3" Tri-seal tank ball boxed	12

American Standard* Seat Disc Tank Ball

(for small tilt flush valves)



C04024



T02025

- CARTON QUANTITIES ONLY
- Units are in a plastic housing to protect the shape of the seats

PART NO.	DESCRIPTION	CTN QTY
C04024	Screw-on unit	25
C04025	Snap-on unit	25
T02025	Combo seat disc, snap-on and screw-on	25

* The manufacturers' names are used only to describe whose products the tank levers will fit. The tank levers are not manufactured by those companies.

Float Ball



- CARTON QUANTITIES ONLY ON THE C05041

PART NO.	DESCRIPTION	CTN QTY
C05040	Plastic 4" x 5"	24
C05041	Copper 4" x 5"	12

Flappers



C04005



C04006 comes with strap and chain



C04007 comes with strap and chain



C04008



C04010



C04011

- High grade vinyl construction
- CARTON QUANTITIES ONLY
- New boxing to protect shape of units

PART NO.	DESCRIPTION	CTN QTY
C04005	3 way with strap (fits plastic, brass and old Crane* 57 flush valves)	10
C04006	3 way with stainless chain (fits plastic, brass and old Crane* 57 flush valves)	10
C04007	Standard unit (9" chain)	10
C04008	Kohler* unit (8" chain)	10
C04010	Crane* unit (9" chain)	10
C04011	Eljer* original unit with rigid arms and foam cone with beaded chain	10

* The manufacturers' names are used only to describe whose products the products will fit.

Kohler Rialto™ Flapper



C04028



C04029



- 5 year warranty
- Blister carded for easy display
- Made from high grade chlorazone
- Resists chemicals and toilet tank cleaners

PART NO.	DESCRIPTION	FITS KOHLER MODELS	CTN QTY
C04028	Kohler Flapper 2010 BP	Rialto, San Raphael, Santa Martine and Rosario	12
C04029	Sharkfin Flapper 2012 BP	Rialto, San Raphael, Santa Rosa, Revival and Gabrielle	12

2 Way Flapper With Separate Trunion



- Siliconized chemical resistant material
- Stainless steel chain

PART NO.	DESCRIPTION	CTN QTY
C04002	2 way flapper	12

Carded Blue Vinyl Flapper



- Chemical resistant
- Individually carded
- Soft body replacement flapper
- 9" stainless steel chain and hook
- Five year warranty on flapper life

PART NO.	DESCRIPTION	CTN QTY
C04004	Carded blue fit-all vinyl flapper	25

Jumbo ToTo Style Flapper



PART NO.	DESCRIPTION	CTN QTY
C04000	Blue Flapper (Power Gravity)	1
C04001	Red Flapper (G-Max)	1

Blue Vinyl Flapper



- Chemical Resistant
- Five Year Warranty
- Fits most plastic flush valves
- CARTON QUANTITIES ONLY
- Easily installed- no collar to cut
- 9" stainless steel chain and hook



PART NO.	DESCRIPTION	CTN QTY
C04014	Blue vinyl flapper	80 bulk

Korky® Flappers



C04032

- C04032 Fits Kohler® Class Five™ Flapper
- Larger 3 1/4" replacement flapper
 - Replaces Kohler No. 1016546 & 1042313
 - Engineered materials resist chlorine



C04033

- C04033 Fits Eljer®Titan™ Flapper
- Replaces Eljer No. 495-6077-00
 - Engineered materials chlorine



C04033

- C04034 Fits American Standard® Cadet 3® Flapper
- Replaces American Stand No. 738920-0070P
 - Engineered materials resist chlorine

PART NO.	DESCRIPTION	CTN QTY
C04032	Fits Kohler® Class Five™ Flapper	5
C04033	Fits Eljer®Titan™ Flapper	5
C04034	Fits American Standard® Cadet 3® Flapper	5

Korky® Flappers

The Original Korky® Flapper



- No tank centering
- Assures a positive seal
- Easy fingertip operation
- Individually carded in cartons
- Eliminates lift wire misalignment
- Chemical resistant- Effective--/--/07 in areas with poor water quality



PART NO.	DESCRIPTION	CTN QTY
C04015	(54 BP)	12/72
C04017	Fits Kohler (58 BP)	10/100

Red Korky® Plus Flapper



- Guaranteed chemical resistant for 5 years
- Individually carded in cartons of 12



PART NO.	DESCRIPTION	CTN QTY
C04016	Red Korky® Plus (2001BP)	12/72

Korky® 1.6 Adjustable Flapper



- Chemical resistant
- Easy to install and adjust
- Individually carded in cartons of 12
- Flush volume changes with just a twist
- Can be used as a water saving device
- Adjustable sealing ball for precise water control
- Universal design fits most popular brands of 1.6 toilets



PART NO.	DESCRIPTION	CTN QTY
C04027	Korky® 1.6 adjustable flapper (16BP)	12/72

Korky® Plus Adjustable Flapper



- Adjust flush volume with movable float on chain
- Slide the float up for water savings or down for increased flush volume
- Premium red Chlorazone rubber resists chlorine



PART NO.	DESCRIPTION	CTN QTY
C04013	Korky® Plus adjustable flapper	12

Closest Spuds



- Cast brass
- Includes spud washer and metal friction ring

PART NO.	DESCRIPTION	CTN QTY
C27125	1 1/4"	25
C27150	1 1/2"	25
C27200	2"	25
C27201	2" x 1 1/4"	25
C27202	2" x 1 1/2"	25
C27127	1 1/2" x 1 1/4"	25
C27150A	1 1/2" (For American Standard)	25

Urinal Spuds



- Cast brass
- Includes spud washer and metal friction ring

PART NO.	DESCRIPTION	CTN QTY
C27134	1" x 3/4"	25
C27126	1 1/4" x 3/4"	25
C27310	1 1/2" x 3/4"	25

Closest Spud Washers



- CARTON QUANTITIES ONLY

PART NO.	DESCRIPTION	CTN QTY
C27301	1 1/4"	25
C27302	1 1/2"	25
C27303	2"	25
C27304	2" x 1 1/4"	25
C27305	2" x 1 1/2"	25
C27308	1" x 3/4"	25
C27309	1 1/4" x 3/4"	25

Closest Spud Friction Rings



- Zinc plated
- CARTON QUANTITIES ONLY

PART NO.	SIZE	CTN QTY
C27321	1 1/4"	25
C27322	1 1/2"	25
C27323	2"	25
C27324	2" x 1 1/4"	25
C27325	2" x 1 1/2"	25
C27328	1" x 3/4"	25

Flush Valve Shank Washer



• 3 1/16" OD x 2 1/4" ID

PART NO.	DESCRIPTION	CTN QTY
T02028	3/8" Height flush valve shank washer	100

Aqua Seal Washer



• Rubber
• American Standard Top Hat Washer

PART NO.	DESCRIPTION	CTN QTY
T85057	Aqua Seal Washer	100

Beveled Ballcock Shank Washer



• Rubber
• 1 3/4" OD x 15/16" ID

PART NO.	DESCRIPTION	CTN QTY
T85056	1/2" Beveled Ballcock shank Washer	100

Flat Bibb Washer



• Priced per carton
• 100 pieces per carton

PART NO.	SIZE	TRADE SIZE	OD	CTN QTY
O25202	1/4"	00	1/2"	100
O25203	1/4"	0	17/32"	100
O25204	1/4"	1/4	9/16"	100
O25205	1/4"	1/4L	19/32"	100
O25206	3/8"	3/8	5/8"	100
O25207	3/8"	3/8M	21/32"	100
O25208	3/8"	3/8L	11/16"	100
O25209	1/2"	1/2	3/4"	100
O25210	1/2"	1/2L	25/32"	100

Beveled Bibb Washer



• Priced per carton
• 100 pieces per carton

PART NO.	SIZE	TRADE SIZE	OD	CTN QTY
O25302	1/4"	00	1/2"	100
O25303	1/4"	0	17/32"	100
O25304	1/4"	1/4	9/16"	100
O25305	1/4"	1/4L	19/32"	100
O25306	3/8"	3/8	5/8"	100
O25307	3/8"	3/8M	21/32"	100
O25308	3/8"	3/8L	11/16"	100
O25309	1/2"	1/2	3/4"	100
O25310	1/2"	1/2L	25/32"	100

Sponge Closet Gaskets



• All have 2 bolt holes

G13500 G13534 G13634

PART NO.	OD x ID x THICKNESS	CTN QTY
G13534	5 3/8" x 3 1/2" x 3/4"	10
G13516	5 3/8" x 3 1/2" x 9/16"	10
G13634	6 3/4" x 3 1/2" x 3/4" w/ 2 bolt holes	10
G13601	6 3/4" x 3 1/2" x 1" w/ 2 bolt holes	10
G13616	6 3/4" x 3 1/2" x 9/16" w/ 2 bolt holes	10
G13638	6 3/4" x 3 1/2" x 3/8" w/ 2 bolt holes	10
G13500	4 3/8" x 2 7/8" x 1/2" wall hung urinal	10

Brass Lift Wire Guide



• Fit-All
• CARTON QUANTITIES ONLY

C05056 C05057

PART NO.	DESCRIPTION	CTN QTY
C05056	Adjustable heavy pattern	10
C05057	Standard split ring	10

Brass Lift Wire



• CARTON QUANTITIES ONLY

PART NO.	DESCRIPTION	CTN QTY
C05045	4 1/2" lower	25
C05046	5" lower	25
C05047	5 1/2" lower	25
C05048	8" upper	25
C05049	9" upper	25

Copper Refill Tube



• CARTON QUANTITIES ONLY

PART NO.	SIZE	CTN QTY
C05051	9"	25

Brass Float Rod



• CARTON QUANTITIES ONLY

PART NO.	SIZE	CTN QTY
C05052	1/4" x 8"	25
C05053	1/4" x 10"	25
C05054	1/4" x 12"	25

Brass Overflow Tube



• 22 gauge

PART NO.	SIZE	CTN QTY
C05042	1" x 1 1/8" x 10"	20

Douglas Flush Valve



C05070



C05071

- Brass unit includes split guide
- Includes locknut, beveled washer
- Plastic unit includes flapper tank ball

PART NO.	DESCRIPTION	CTN QTY
C05070	Plastic with stainless steel chain	50
C05071	Brass	2

Mansfield* Style Ballcock



- All brass
- Compound lever

PART NO.	DESCRIPTION	CTN QTY
T02075	Brass Ballcock	1

* The manufacturer's name is used only to describe whose product the ballcock will fit. The part listed is not necessarily manufactured by that company.

Mansfield Style Ballcock With Float Rod



T03008



T03009

- Genuine Mansfield Ballcock

PART NO.	DESCRIPTION	CTN QTY
T03008	Ballcock with float rod #08	1
T03009	Ballcock with float rod #09	1

Mansfield Flush Valve #210



- Water saver
- 3.5 gal. toilets
- Instant shut-off
- Won't rust or corrode

PART NO.	DESCRIPTION	CTN QTY
T02066	Flush Valve	1

Plastic Coast Flush Valve



PART NO.	DESCRIPTION	CTN QTY
C05073	Flush Valve	1

Korky® QuietFill Valve



- Resists chlorine
- 5 year guarantee



PART NO.	DESCRIPTION	CTN QTY
C05200	Korky® QuietFill Valve	1

American Standard* Toilet Repair Parts



T02020



T02021



T02022



T02023



T02024



T02026

PART NO.	DESCRIPTION	CTN QTY
T02020	#5 (33642-07) old style low profile actuator unit, black, with disc, chain, clip and grommet	5
T02021	#6 (72880-07) old style high profile actuator unit, complete, black with disc, chain, clip and grommet	5
T02022	#4 (8162-07) old style high profile actuator unit with legs for one piece low boy* with brass flush valves, complete, black with disc, chain, clip, grommet and legs	5
T02023	#4 (70711-07) old style Cadet* water saver actuator unit, white with blue cap complete with disc, chain, clip and grommet	5
T02024	Chain kit complete for all actuator units (American Standard* 8321-07)	10
T02026	#4 (47107-07) new style complete flush valve unit, white, short actuator	5
T02027	#5 (47089-07) complete flush valve tall black for standard two-piece closets	5

Ballcock Repair Parts For American Standard*



T02035



T02036

PART NO.	DESCRIPTION	CTN QTY
T02035	7307 cap and plunger with seat, new style	10
T02036	N3010 ballcock plunger with thumb hole	10

Ballcock Repair Parts For Coast*



T02037



T02038



T02039

PART NO.	DESCRIPTION	CTN QTY
T02037	Coast 1B1*, 1B1P*, standard large head kit with 3 screws	10
T02038	Coast 1B1A*, smaller head kit with 3 screws	10
T02039	Coast 1B1X*, Kohler*, UR*, Eljer*, Briggs*, American Standard*, kits with 3 screws, high and low boy	10

Ballcock Repair Parts For Hoover* / Amerline*



PART NO.	DESCRIPTION	CTN QTY
T02050	Standard kit with 4 screws	10

Ballcock Repair Parts For Kohler*



PART NO.	DESCRIPTION	CTN QTY
T02051	Black plunger with cap and seal	10

Ballcock Repair Parts For Fluidmaster*



T02052



T02053

PART NO.	DESCRIPTION	CTN QTY
T02052	Diaphragm N/S heavy duty white for hard water and chloramines (Ref. 242F)	10
T02053	Standard black diaphragm (Ref. 242)	25

Mansfield Ballcock and Flush Valve Repair Parts



T02060



T02062



T02063



T02064



T02065

* Original Mansfield parts

PART NO.	DESCRIPTION	CTN QTY
T02060	03, 09, XQ-16 ballcock repair kit	10
T02062	08 ballcock repair kit	10
T02063	12 ballcock repair kit	10
T02064	208/209 flush valve diaphragm	10
T02065	210/211 flush valve seal	10

Dual Flush Toilet Kit



- Simple to install
- Save water with every flush!
- Push one way to rinse liquid
- Push the other way to flush solids

PART NO.	DESCRIPTION	CTN QTY
T02067	Dual Flush Toilet Kit	12

Replacement Tanks



- Comes in white
- Made from high impact resins
- Installer sets up for either 1.6 or 3.5 gallon flush
- Fits most toilets including 2-3-4 bolt, bowl or wall mounted
- Includes ballcock kit with handle, flush valve assembly and adapter kit

PART NO.	DESCRIPTION	CTN QTY
T02006	Economy tank	1
T02007	Insulated tank	1

Toilet Tank Cover



- Fit-All
- White plastic
- Fits most tanks with outside dimensions of 21 1/8" x 7 3/8" or less

PART NO.	DESCRIPTION	CTN QTY
T02005	White	1

Enduro Closet Bolts



- Never Rusts
- Space age composite
- Fits all closet flange styles
- CARTON QUANTITIES ONLY
- Withstands over 1,000 PSI

PART NO.	DESCRIPTION	CTN QTY
C02050	5/16" x 2 1/2" closet bolt	50 pairs

Enduro Closet Bolt Jar Display



- Never rusts
- Space age material
- Fits all closet flange styles

PART NO.	DESCRIPTION	CTN QTY
CJ1003	5/16" x 2 1/2" closet bolt	50 pairs

Flexible and Rigid Super Shims

MADE IN THE USA



- Stackable
- Rigid, can be driven
- Flexible, can be trimmed
- Priced per bag
- 10 per bag

PART NO.	DESCRIPTION	CTN QTY
S55950	1-1/8" x 1-15/16" x 1/4" flexible	1 bag of 10
S55951	1-1/8" x 1-15/16" x 1/4" rigid	1 bag of 10

Closet Wedge Shims

MADE IN THE USA



- Stackable
- 3/8" width x 1-3/8" length x 5/16" height
- Easily trimmed to desired height
- Priced per bag or display

PART NO.	DESCRIPTION	CTN QTY
S55902	100 shims poly bagged	1 bag of 100
S55903	1000 shims counter display	1 bag of 100

Flexible Super Shims



- 200 Flexible super shims packaged in a convenient refillable "candy bowl" counter display
- Priced per display

MADE IN THE
USA

PART NO.	DESCRIPTION	CTN QTY
S55952	200 Flexible super shims	1 bowl of 200

Rigid Super Shims



- 200 Rigid super shims packaged in a convenient refillable "candy bowl" counter display
- Priced per display

MADE IN THE
USA

PART NO.	DESCRIPTION	CTN QTY
S55953	200 Rigid super shims	1 bowl of 200

"Bucket Of Bolts"



- Attractive counter/shelf display
- Closet bolts are custom packed (2 bolts, nuts, and washers per bag)

Brass Plated

PART NO.	SIZE	WASHER	CTN QTY
CB2001	1/4" x 2 1/4"	Oval	50 pairs
CB2011	1/4" x 2 1/4"	Round	50 pairs
CB2002	1/4" x 3 1/2"	Oval	50 pairs
CB2012	1/4" x 3 1/2"	Round	50 pairs
CB2003	5/16" x 1 3/4"	Oval	50 pairs
CB2013	5/16" x 1 3/4"	Round	50 pairs
CB2004	5/16" x 2 1/4"	Oval	50 pairs
CB2014	5/16" x 2 1/4"	Round	50 pairs
CB2005	5/16" x 3 1/2"	Oval	50 pairs
CB2015	5/16" x 3 1/2"	Round	50 pairs

Brass

PART NO.	SIZE	WASHER	CTN QTY
CB2021	1/4" x 2 1/4"	Oval	50 pairs
CB2030	1/4" x 2 1/4"	Round	50 pairs
CB2022	1/4" x 3 1/2"	Oval	50 pairs
CB2031	1/4" x 3 1/2"	Round	50 pairs
CB2023	5/16" x 1 3/4"	Oval	50 pairs
CB2032	5/16" x 1 3/4"	Round	50 pairs
CB2024	5/16" x 2 1/4"	Oval	50 pairs
CB2033	5/16" x 2 1/4"	Round	50 pairs
CB2025	5/16" x 3 1/2"	Oval	50 pairs
CB2034	5/16" x 3 1/2"	Round	50 pairs

Closet Bolts With Tinnerman Nuts



- CARTON QUANTITIES ONLY
- Two each bolts, nuts, round washers and tinnerman nuts per bag

Brass Plated

PART NO.	SIZE	CTN QTY
C02401	1/4" x 2 1/4"	50 pairs
C02402	1/4" x 3 1/2"	50 pairs
C02403	5/16" x 1 3/4"	50 pairs
C02404	5/16" x 2 1/4"	50 pairs
C02405	5/16" x 3 1/2"	50 pairs

Brass

PART NO.	SIZE	CTN QTY
C02421	1/4" x 2 1/4"	50 pairs
C02990	1/4" x 3 1/2"	50 pairs
C02422	5/16" x 1 3/4"	50 pairs
C02423	5/16" x 2 1/4"	50 pairs
C02424	5/16" x 3 1/2"	50 pairs

Closet Bolts



- Packed with acorn nuts and washers
- CARTON QUANTITIES ONLY
- Custom Packed

Brass Plated Bolts, Zinc Plated Washers and Acorn Nuts

Custom Packed - Two each bolts, nuts, washers and acorn nuts per bag

PART NO.	SIZE	WASHER	CTN QTY
C02000	1/4" x 1 3/4"	Oval	50 pairs
C02001	1/4" x 2 1/4"	Oval	50 pairs
C02002	1/4" x 3 1/2"	Oval	50 pairs
C02003	5/16" x 1 3/4"	Oval	50 pairs
C02004	5/16" x 2 1/4"	Oval	50 pairs
C02005	5/16" x 3 1/2"	Oval	50 pairs
C02010	1/4" x 1 3/4"	Round	50 pairs
C02011	1/4" x 2 1/4"	Round	50 pairs
C02012	1/4" x 3 1/2"	Round	50 pairs
C02013	5/16" x 1 3/4"	Round	50 pairs
C02014	5/16" x 2 1/4"	Round	50 pairs
C02015	5/16" x 3 1/2"	Round	50 pairs

Brass Bolts, Stainless Washers, Nickel Plated Acorn Nuts

Custom Packed - Two each bolts, nuts, washers and acorn nuts per bag

PART NO.	SIZE	WASHER	CTN QTY
C02020	1/4" x 1 3/4"	Oval	50 pairs
C02021	1/4" x 2 1/4"	Oval	50 pairs
C02022	1/4" x 3 1/2"	Oval	50 pairs
C02023	5/16" x 1 3/4"	Oval	50 pairs
C02024	5/16" x 2 1/4"	Oval	50 pairs
C02025	5/16" x 3 1/2"	Oval	50 pairs
C02029	1/4" x 1 3/4"	Round	50 pairs
C02030	1/4" x 2 1/4"	Round	50 pairs
C02031	1/4" x 3 1/2"	Round	50 pairs
C02032	5/16" x 1 3/4"	Round	50 pairs
C02033	5/16" x 2 1/4"	Round	50 pairs
C02034	5/16" x 3 1/2"	Round	50 pairs

Close Bolt



- Packed with acorn nuts and washers
- CARTON QUANTITIES ONLY
- Bulk Packed

Brass Plated Bolts, Zinc Plated Washers and Acorn Nuts

Bulk Packed - One each bolt, nut, washer and acorn nut per bag

PART NO.	SIZE	WASHER	CTN QTY
C02000B	1/4" x 1 3/4"	Oval	100 each
C02001B	1/4" x 2 1/4"	Oval	100 each
C02002B	1/4" x 3 1/2"	Oval	100 each
C02003B	5/16" x 1 3/4"	Oval	100 each
C02004B	5/16" x 2 1/4"	Oval	100 each
C02005B	5/16" x 3 1/2"	Oval	100 each
C02010B	1/4" x 1 3/4"	Round	100 each
C02011B	1/4" x 2 1/4"	Round	100 each
C02012B	1/4" x 3 1/2"	Round	100 each
C02013B	5/16" x 1 3/4"	Round	100 each
C02014B	5/16" x 2 1/4"	Round	100 each
C02015B	5/16" x 3 1/2"	Round	100 each

Brass Bolts, Stainless Washers, Nickel Plated Acorn Nuts

Bulk Packed - One each bolt, nut, washer and acorn nut per bag

PART NO.	SIZE	WASHER	CTN QTY
C02020B	1/4" x 1 3/4"	Oval	100 each
C02021B	1/4" x 2 1/4"	Oval	100 each
C02022B	1/4" x 3 1/2"	Oval	100 each
C02023B	5/16" x 1 3/4"	Oval	100 each
C02024B	5/16" x 2 1/4"	Oval	100 each
C02025B	5/16" x 3 1/2"	Oval	100 each
C02029B	1/4" x 1 3/4"	Round	100 each
C02030B	1/4" x 2 1/4"	Round	100 each
C02031B	1/4" x 3 1/2"	Round	100 each
C02032B	5/16" x 1 3/4"	Round	100 each
C02033B	5/16" x 2 1/4"	Round	100 each
C02034B	5/16" x 3 1/2"	Round	100 each

Close Bolt Component Parts



Close Bolt

Close Bolt Screw

Tinnerman Nut

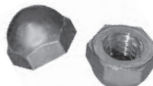

Close Acorn Nut



Open Acorn Nut



Oval Washer



Round Washer

PART NO.	DESCRIPTION	CTN QTY
C02800	1/4" x 1 3/4" brass plated closet bolt	100
C02801	1/4" x 2 1/4" brass plated bolt	100
C02802	1/4" x 3 1/2" brass plated bolt	100
C02803	5/16" x 1 3/4" brass plated bolt	100
C02804	5/16" x 2 1/4" brass plated bolt	100
C02805	5/16" x 3 1/2" brass plated bolt	100
C02820	1/4" x 1 3/4" brass bolt	100
C02821	1/4" x 2 1/4" brass bolt	100
C02822	1/4" x 3 1/2" brass bolt	100
C02823	5/16" x 1 3/4" brass bolt	100
C02824	5/16" x 2 1/4" brass bolt	100
C02825	5/16" x 3 1/2" brass bolt	100
C02830	1/4" x 2 1/4" brass snap-off bolt	100
C02832	5/16" x 2 1/4" brass snap-off bolt	100
C02808	1/4" x 2 1/2" brass plated screw	100
C02815	1/4" x 3 1/2" brass plated screw	100
C02811	5/16" x 2 1/2" brass plated screw	100
C02812	1/4" x 2 1/2" brass screw	100
C02813	1/4" x 3 1/2" brass screw	100
C02814	5/16" x 2 1/2" brass screw	100
C02807	5/16" tinnerman nut	100
C02860	1/4" x 7/16" nickel plated open acorn nut	100
C02861	1/4" x 7/16" zinc plated open acorn nut	100
C02862	5/16" x 9/16" nickel plated open acorn nut	100
C02863	5/16" x 9/16" zinc plated open acorn nut	100
C02809	1/4" x 7/16" zinc plated closed acorn nut	100
C02810	5/16" x 9/16" zinc plated closed acorn nut	100
C02900	1/4" nickel plated closed acorn nut	100
C02901	5/16" nickel plated closed acorn nut	100
C02864	1/4" brass open acorn nut	100
C02865	5/16" brass open acorn nut	100
C02850	Oval stainless steel washer	100
C02851	Oval zinc plated washer	100
C02852	Round stainless steel washer	100
C02853	Round zinc plated washer	100

Snap-Off Closet Bolts



Counter Display

- Custom packed
- 2 each: Brass bolts, captive washers, nickel nuts, and stainless washers
- Available boxed or in counter display ("Bucket of Bolts")

Boxed

PART NO.	SIZE	WASHER	CTN QTY
C02040	1/4" x 2 1/4"	Oval	50 pairs
C02045	1/4" x 2 1/4"	Round	50 pairs
C02041	5/16" x 2 1/4"	Oval	50 pairs
C02046	5/16" x 2 1/4"	Round	50 pairs

Counter Display

PART NO.	SIZE	WASHER	CTN QTY
CB2040	1/4" x 3 1/2"	Oval	50 pairs
CB2045	1/4" x 3 1/2"	Round	50 pairs
CB2041	5/16" x 1 3/4"	Oval	50 pairs
CB2046	5/16" x 1 3/4"	Round	50 pairs

Closet Bolt - Elite Packs



- CARTON QUANTITIES ONLY

Packed with 4 acorn nuts and 4 washers

PART NO.	DESCRIPTION	CTN QTY
C02989	5/16" x 1 3/4" brass plated bolts	50 pairs
C02999	1/4" x 2 1/4" brass plated bolts	50 pairs
C02998	1/4" x 2 1/4" solid brass bolts	50 pairs
C02997	1/4" x 3 1/2" brass plated bolts	50 pairs
C02996	1/4" x 3 1/2" solid brass bolts	50 pairs
C02992	1/4" x 2 1/4" solid brass bolts	50 pairs
C02993	5/16" x 2 1/4" brass plated bolts	50 pairs

Packed with 2 acorn nuts, 2 hex nuts, and 4 washers

PART NO.	DESCRIPTION	CTN QTY
C02995	1/4" x 2 1/4" brass plated bolts	50 pairs
C02994	1/4" x 2 1/4" solid brass bolts	50 pairs

Packed with 2 acorn nuts, 2 hex nuts, 4 washers, and 2 tinnerman nuts

PART NO.	DESCRIPTION	CTN QTY
C02987	1/4" x 2 1/4" solid brass bolts	50 pairs

Closet Bolt Cap



Oval Cap

Round Cap

- CARTON QUANTITIES ONLY

Bulk Packed - Priced Per Cap And Washer

PART NO.	DESCRIPTION	CTN QTY
C02100	Oval white (less washer)	100
C02105	Round white (with washer)	100
C02106	Round bone (with washer)	100

Custom Packed - Priced Per Bag Of Two Each

PART NO.	DESCRIPTION	CTN QTY
C02103	Round white (with washer)	50 pairs
C02104	Round bone (with washer)	50 pairs

Closet Screws



With Round Washer

With Oval Washer

- CARTON QUANTITIES ONLY
- Two each screws, nuts, and washers per bag

Brass Plated

PART NO.	SIZE	WASHER	CTN QTY
C02210	1/4" x 2 1/2"	Round	50 pairs
C02202	1/4" x 3 1/2"	Round	50 pairs
C02211	5/16" x 2 1/2"	Round	50 pairs
C02200	1/4" x 2 1/2"	Oval	50 pairs
C02203	1/4" x 3 1/2"	Oval	50 pairs
C02201	5/16" x 2 1/2"	Oval	50 pairs

Brass

PART NO.	SIZE	WASHER	CTN QTY
C02310	1/4" x 2 1/2"	Round	50 pairs
C02302	1/4" x 3 1/2"	Round	50 pairs
C02311	5/16" x 2 1/2"	Round	50 pairs
C02300	1/4" x 2 1/2"	Oval	50 pairs
C02303	1/4" x 3 1/2"	Oval	50 pairs
C02301	5/16" x 2 1/2"	Oval	50 pairs

Tank to Bowl Set



- CARTON QUANTITIES ONLY
- Universal fit sponge rubber gasket
- Domed poly wingnut fits into china, eliminating bottom washer

PART NO.	DESCRIPTION	BOLT	CTN QTY
C03250	5/16" x 3"	Brass plated	50 pairs
C03251	5/16" x 3" with gasket	Brass plated	50 pairs
C03252	5/16" x 3"	Brass	50 pairs
C03253	5/16" x 3" with gasket	Brass	50 pairs

Tank To Bowl Bolt Set



- CARTON QUANTITIES ONLY
- Universal fit sponge rubber gasket

With Wing Nut

PART NO.	DESCRIPTION	BOLT	CTN QTY
C03200	5/16" x 3"	Brass plated	50 pairs
C03201	5/16" x 3" with gasket	Brass plated	25 pairs
C03202	5/16" x 3"	Brass	50 pairs
C03203	5/16" x 3" with gasket	Brass	25 pairs

With Hex Nut

PART NO.	DESCRIPTION	BOLT	CTN QTY
C03210	5/16" x 3"	Brass plated	50 pairs
C03211	5/16" x 3" with gasket	Brass plated	25 pairs
C03212	5/16" x 3"	Brass	50 pairs
C03213	5/16" x 3" with gasket	Brass	25 pairs

With Hex Nut and Wing Nut

PART NO.	DESCRIPTION	BOLT	CTN QTY
C03240	5/16" x 3"	Brass	50 pairs

Tank to Bowl Bolt Kit For Mansfield*



- Includes brass plated bolts, hex nuts, round washers, sponge rubber gasket and ballcock coupling nut

PART NO.	DESCRIPTION	CTN QTY
C03260	Mansfield* kit	25

Tank to Bowl Bolt Kit For Gerber*



- Includes brass bolts, hex nuts, round washers, sponge rubber gasket and ballcock coupling nut

PART NO.	DESCRIPTION	CTN QTY
C03265	Gerber* kit	25

Tank to Bowl Bolt Kit for American Standard*



- Includes bolts, nuts, round washers and sponge rubber gasket

PART NO.	DESCRIPTION	CTN QTY
C03270	American Standard* kit (brass plated bolts)	25
C03271	American Standard* (brass bolts)	25

Tri-Tank To Bowl Bolt Kit For American Standard*



- Brass plated

PART NO.	DESCRIPTION	CTN QTY
C03272	American Standard* Tank to Bowl Bolt Kit	25

Tri-Bolt Tank To Bowl Bolt Set



- For units requiring 3-bolt attachment
- Custom packed with 3 brass bolts, washers and hex nuts

PART NO.	DESCRIPTION	CTN QTY
C03280	5/16" x 3"	50

Offset Tank To Bowl Bolts



- All Brass
- Rubber washers
- 2" maximum adjustment

PART NO.	DESCRIPTION	CTN QTY
C02075	Offset tank to bowl bolts	20

Tank To Bowl Components



C03800



C03803



C03804



C03805



C03807



C03810



C02852

PART NO.	DESCRIPTION	CTN QTY
C03800	5/16"-18 x 3" brass plated tank bolt	100
C03801	5/16"-18 x 3" brass tank bolt	100
C03803	5/16"-18 brass plated forged wing nut	100
C03804	5/16"-18 brass plated heavy hex jam nut	100
C03805	5/16"-18 brass heavy hex jam nut	100
C03807	5/16" acetal tank bowl wing nut	100
C03810	Cloth inserted washer	100
C02852	Stainless steel washer	100

Tank to Bowl Gasket



C03300



C03301



C03302



C03303

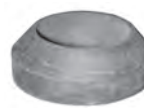

C03304



C03305

- Close coupled tank to bowl gaskets
- Beveled sponge rubber material
- CARTON QUANTITIES ONLY

Universal Fit-All

PART NO.	DESCRIPTION	CTN QTY
C03300	2 1/4" ID x 3 3/8" OD x 11/16" thick	25

Kohler* (fits Alamo and other Kohler* integral units with two piece closets)

PART NO.	DESCRIPTION	CTN QTY
C03301	2 1/2" ID x 3 3/4" OD x 3/4" thick	25

Eljer* (rubber)

PART NO.	DESCRIPTION	CTN QTY
C03302	2 5/16" ID x 3 1/8" OD x 3/8" thick	25

American Standard Cadet*, Kohler*, Crane*, Borg Warner*

PART NO.	DESCRIPTION	CTN QTY
C03303	2 1/8" ID x 3 1/2" OD x 1 1/4" thick	25

Crane*

PART NO.	DESCRIPTION	CTN QTY
C03304	2 1/8" ID x 3 1/4" OD x 1 1/16" thick	25

Gerber* (free standing late models)

PART NO.	DESCRIPTION	CTN QTY
C03305	2 1/8" ID x 3 1/4" OD x 1 3/16" thick	25

Mansfield*

PART NO.	DESCRIPTION	CTN QTY
C03306	2 1/2" ID x 3 5/8" OD x 3/4" thick	25

Wax Gaskets



Standard Wax Gasket

With Plastic Flange

- Boxed
- CARTON QUANTITIES ONLY

PART NO.	DESCRIPTION	CTN QTY
G13001	Full size standard wax gasket	48
G13002	Gasket with plastic flange	24
G13003	Urinal gasket- fits 2" outlet	12
G13004	Jumbo wax gasket	12

Radiant Seal Sponge Rubber Closet Gasket



- Easy installation
- Unaffected by radiant heat
- Seals effectively with uneven floors
- 3 3/4" ID x 5 1/8" OD x 1/2" Thick

PART NO.	DESCRIPTION	CTN QTY
G13005	3 3/4" ID x 5 1/8" OD x 1/2" thick	1

Closet Bend Spacer



- One size fits all
- Eliminates the need to chip out concrete
- 6" OD x 4" high (fits 3" and 4" waste lines)
- Keeps poured concrete away from waste lines and closet bends
- Replaces styrofoam, styrene coverings, coffee cans and duct tape
- CARTON QUANTITIES ONLY

PART NO.	DESCRIPTION	CTN QTY
S12005	Closet bend spacer	18

Styrofoam Closet Flange Spacer



- Eliminates needless chipping of concrete
- Styrofoam breaks away or melts with flame
- Bulk pack- CARTON QUANTITIES ONLY

PART NO.	DESCRIPTION	CTN QTY
S13130	3" Flange spacer	120
S13140	4" Flange spacer	120

Foam Spacer



- Foam closet bend protector
- CARTON QUANTITIES ONLY

PART NO.	DESCRIPTION	CTN QTY
S13240	4"x 4" foam spacer	60

Shower Rod Flanges



- Flanges fit 15/16" and 1" OD rod
- CARTON QUANTITIES ONLY

PART NO.	DESCRIPTION	CTN QTY
S02150	Jiffy flange chrome-plated plastic	50
S02151	Jiffy flange chrome die cast zinc	25
S02152	Chrome flanges with screws (bagged)	50

Jumbo Shower Bar Flange



PART NO.	DESCRIPTION	CTN QTY
S02300	Jumbo shower bar flange	20

Contoured Shower Rod

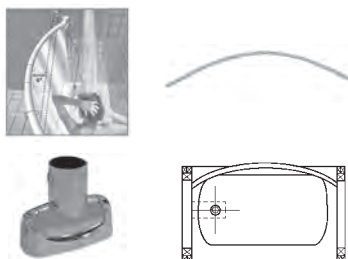

- Brings shower curtain in front of wall to prevent gaps and leaks
- Perfect for 60° oval or standard tubs
- Adjusts easily with tube cutter for shorter walls
- Sweeping curve increases space in center of oval tubs
- Sturdy alloy rods with zinc angled mounting brackets
- Multiple applications - residential, hotel, motel, assisted living, etc.

PART NO.	DESCRIPTION	CTN QTY
S02190	Chrome plated	1
S02191	White	1
S02193	Satin Nickel	1

Aluminum Shower Rod



- 1" OD - .025 wall (22 gauge)
- Individually wrapped
- CARTON QUANTITIES ONLY

PART NO.	DESCRIPTION	CTN QTY
S02055	5' rod	50
S02015	5' rod	10
S02056	6' rod	50
S02016	6' rod	10

Aluminum Shower Rod With Holders



- 1" OD - .025 wall (22 gauge)
- Fifty each Individually wrapped rods and holders boxed together
- 10 packs (S02071/-072/-073/-074)
- CARTON QUANTITIES ONLY

PART NO.	DESCRIPTION	CTN QTY
S02057	5' rod with plastic Jiffy flange	50
S02058	5' rod with die cast Jiffy flange	50
S02059	5' rod with chrome flange and screws	50
S02071	5' rod with chrome flange and screws	10
S02072	6' rod with chrome flange and screws	10
S02073	5' rod with plastic Jiffy flange	10
S02074	6' rod with plastic Jiffy flange	10

Adjustable Aluminum Shower Curtain Rod



- Sturdy, self-supporting
- 1" OD/.025 wall (22 gauge)
- Expandable from 58" to 61" or 69" to 73"
- Individually wrapped
- CARTON QUANTITIES ONLY

PART NO.	DESCRIPTION	CTN QTY
S02070	Adjustable shower rod 58" - 61" (bulk)	50
S02066	Adjustable shower rod 69" - 73" (bulk)	50
S02069	Adjustable shower rod 58" - 61" (10 pack)	10

Deluxe Shower Head



- 2.5 gpm flow rate
- Chrome plated die cast zinc

PART NO.	DESCRIPTION	CTN QTY
S01004	Deluxe shower head	100

Shower Heads



- 2.5 gpm flow rate

Plastic		
PART NO.	DESCRIPTION	CTN QTY
S01001	2" Chrome with plastic ball	50
S01002	2" White with plastic ball	50
S01003	2" Chrome with brass ball	50
Die Cast		
PART NO.	DESCRIPTION	CTN QTY
S01005	2" Chrome- adjustable	50
Brass		
PART NO.	DESCRIPTION	CTN QTY
S01008	1 3/4" Chrome- adjustable	10
S01009	2 1/8" Chrome- adjustable	10
S01010	3" Chrome- adjustable	10

Brass Aerating Water Saver Shower Head



- Permanent built-in water restrictor
- Mixes air and water for invigorating spray
- Restricts water to 2-2.5 gpm, depending on water pressure

PART NO.	DESCRIPTION	CTN QTY
S01013	1" Chrome	10
S01014	1" Chrome with shutoff	10

Vandal Proof Shower Head



- 2.5 gpm flow rate
- Brass ball
- Spray adjusts from coarse to fine
- Secures with set screw, hex key included

PART NO.	DESCRIPTION	CTN QTY
S01015	Chrome plated plastic shower head	1

Adjustable Plastic Shower Head



- 1.5 gpm flow rate
- Chrome plated plastic
- Brass ball

PART NO.	DESCRIPTION	CTN QTY
S01016	Chrome plated adjustable plastic shower head	100

Adjustable Massage Shower Head



- 2.5 gpm flow rate
- Brass ball

PART NO.	DESCRIPTION	CTN QTY
S01020	Chrome plated plastic shower head	1

Octagonal Shower Head



- 2.5 gpm flow rate
- Brass ball

PART NO.	DESCRIPTION	CTN QTY
S01025	Chrome plated octagonal shower head	10

Shower Arms and Kits



Shower Arm



Shower Arm with Flange



"S" Style Shower Arm

- Chrome plated brass arms

PART NO.	DESCRIPTION	CTN QTY
S01030	6" Arm only	1
S01032	8" Arm only	1
S01044	6" Arm and stainless steel flange	1
S01045	8" Arm and stainless steel flange	1
S01035	8" "S" style arm	1
S01038	10" "S" style arm	1

Heavy Adjustable Shower Arm



- 10" length
- Chrome plated brass
- Locking wing nut adjustment

PART NO.	DESCRIPTION	CTN QTY
S01039	1/2" x 10" adjustable	1

Shower Arm and Flange w/Set Screw



- 1/2" x 6" shower arm

PART NO.	DESCRIPTION	CTN QTY
S01042	6" Shower arm and flange w/set screw	25

Plastic Shower Arm



- 1/2" x 6" chrome-plated plastic with flange

PART NO.	DESCRIPTION	CTN QTY
S01049	Plastic shower arm and flange	1

Shower Arm Flange



S01041



S01040

PART NO.	DESCRIPTION	CTN QTY
S01040	Chrome flange with set screw (2 1/2" OD)	50
S01041	Stainless steel flange (2 1/2" OD)	50

Shower Curtain Pin



- CARTON QUANTITY ONLY

PART NO.	DESCRIPTION	CTN QTY
S02100	Shower curtain pin	10

Shower Pan Liner

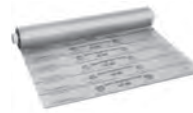

- 40 mil thickness
- Meets ASTM D4551
- FREIGHT LINE ONLY
- PVC shower pan liner is listed by UPC
- Marked in 6 inch increments for easy measurements
- Treated to prevent the growth of fungus, molds and mildew

PART NO.	DESCRIPTION	CTN QTY
S994050	4' x 50'	1
S995040	5' x 40'	1
S996050	6' x 50'	1

PVC Shower Pan Liner Cement



- 3 year shelf life
- Not for PE liner use
- Instant contact strength
- CARTON QUANTITY ONLY

PART NO.	DESCRIPTION	CTN QTY
S99100	Shower pan liner cement (pint)	12

Water Volume Control



- 1/2" female x 1/2" male IPS
- Allows reduced water flow (does not shut water completely off)

PART NO.	DESCRIPTION	CTN QTY
S01060	Chrome-brass	20
S01061	Chrome-plastic	20

Plastic Flow Restrictor



- 2.5 GPM

PART NO.	DESCRIPTION	CTN QTY
S01080	Shower head flow restrictor	25

54" D-Style Add-A-Shower

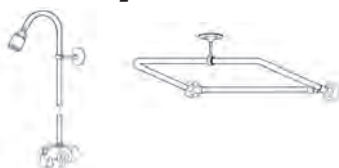

- Heavy duty jumbo flanges
- 61" riser with shower head
- Standard bathcock (3 3/8" centers)
- 54" x 27" chrome plated brass shower rod (1" diameter)

PART NO.	DESCRIPTION	CTN QTY
S10083	54" x 27" D-Style Add-A-Shower	1

Add-A-Shower Complete Unit

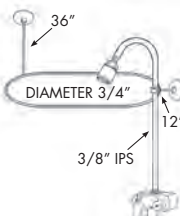

- Bathcock with diverter spout
- Chrome plated plastic shower head
- 61" rise with 12" rod and riser support
- 24" x 42" oval aluminum shower rod with 36" ceiling rod and support

PART NO.	DESCRIPTION	CTN QTY
S10070	Complete unit with S10080 diverter	1
S10069	Complete unit with S10074 diverter	1

Complete Add-A-Shower

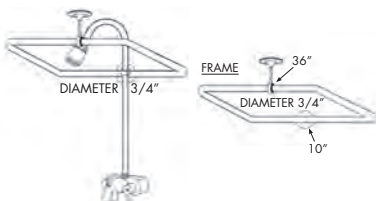

- Rectangular frame
- Aluminum shower rod
- Bathcock with diverter spout
- 3/8" mounting brackets included
- 61" riser with 10" rod and riser support

PART NO.	DESCRIPTION	CTN QTY
S10067	Shower with 24" x 42" frame	1
S10068	24" x 42" Frame only	1

Add-A-Shower Less Oval Shower Rod



- 61" riser and wall support
- Bathcock with diverter spout
- Chrome plated plastic shower head

PART NO.	DESCRIPTION	CTN QTY
S10072	Complete unit	1

Add-A-Shower Diverter Spout & Riser

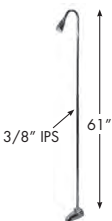

- Diverter valve
- 61" riser with wall support
- Chrome plated plastic shower head

PART NO.	DESCRIPTION	CTN QTY
S10071	Spout and riser	1

Add-A-Shower Code Pattern

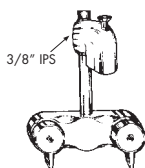

PART NO.	DESCRIPTION	CTN QTY
S10074	Code pattern anti-siphon diverter bathcock	1

Add-A-Shower Accessories

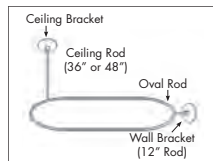

PART NO.	DESCRIPTION	CTN QTY
S10075	24" x 42" oval shower rod	1
B60001	Wall bracket and rod holder with 12" rod (can be cut to fit)	1
B60002	Ceiling bracket and rod holder with standard size 36" rod	1
S10073	48" ceiling rod only	1
S10080	Replacement Bathcock Assembly	1
S10081	Diverter spout only for S10071	1
S10077	Wall bracket for S10071	1
S10078	Diverter spout with 65" riser	1
S10082	61" CP brass riser only	1
S10076	61" CP brass riser with shower head	1

Shower Diverter Valve



- Installs between arm and shower head
- Allows usage of hand-held personal shower or shower head

PART NO.	DESCRIPTION	CTN QTY
S01070	Chrome push button- brass	5

Offset Bath Supplies



- Chrome plated
- 1/2" supply tubes
- All hardware needed for connection included

PART NO.	DESCRIPTION	CTN QTY
B49020	Single offset (pair)	6
B49021	Double offset (pair)	6
B49022	Replacement nuts, washers and escutcheons	6

Utility Shower



- 21" galvanized riser
- Top or bottom connection
- Chrome plated brass body with shower head and soap dish
- Combination 1/2" threaded or sweat connection union inlets on 3" centers

PART NO.	DESCRIPTION	CTN QTY
S10079	Utility shower	6

Bathcocks



B49001



B49002



B49010

- Chrome plated brass body
- Replaceable stem and seat
- 3 3/8" centers and 3/4" threaded inlets

PART NO.	DESCRIPTION	CTN QTY
B49001	"O" pattern with slip-on spout	24
B49002	Code pattern with goose neck spout	24
B49010	Coupling elbows (pair) chrome plated 3/4" bath-cock threads x 1/2" male IPS	1
B49011	Code spout only	1
B49012	Hot repair kit (handle, stem and seat)	1
B49013	Cold repair kit (handle, stem and seat)	1

Brass Trap Bushing



- Heavy pattern/cast
- 1 1/2" sweat x 1 1/2" IPS
- Knurled end for ease of tightening

PART NO.	DESCRIPTION	CTN QTY
B55150	1 1/2" SWT x 1 1/2" MIP	25

Twin Elbow And Face Bushings



FIP x FIP



MIP x FIP

- Brass

PART NO.	DESCRIPTION	CTN QTY
D01040	3/4" FIP x 1/2" FIP twin elbow	10
D01041	3/4" MIP x 1/2" FIP face bushing	10
D01042	1/2" MIP x 3/8" FIP face bushing	10

Brass Shower Elbow For Fiberglass Shower Stall



- Outlet 1/2" FIP
- Secures tub spout nipple
- Secures shower arm to stall
- Lock nuts secure ell to fiberglass wall
- Requires 1 1/8" hole through fiberglass wall
- Combination inlet 1/2" female sweat or 1/2" threaded

PART NO.	DESCRIPTION	CTN QTY
S01050	Brass elbow	6

Diverter Spouts and Extensions



D01001
D01004
D01101
D01104



D01002
D01003
D01103

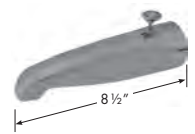

D01015



D01008
D01009



D01030
D01031



D01010



D01011

Chrome Plated Diverter Spouts

PART NO.	DESCRIPTION	CONNECTION	MATERIAL	CTN QTY
D01001	1/2" FIP	Nose	Zamak	10
D01002	3/4" x 1/2" FIP	Base	Zamak	10
D01003	3/4" x 1/2" FIP	Base	Brass	10
D01004	1/2" CTS slide connection (unit includes hex key)	Base	Zamak	10

8 1/2" One Piece Diverter Spouts

PART NO.	DESCRIPTION	CONNECTION	MATERIAL	CTN QTY
D01015	3/4" x 1/2" FIP	Base	Brass	1

Two Piece Diverter Spouts

PART NO.	DESCRIPTION	CONNECTION	MATERIAL	CTN QTY
D01008	8 1/4" two piece	Nose	Zamak	1
D01009	10 1/8" two piece	Nose	Zamak	1

Extension Only

PART NO.	DESCRIPTION	CONNECTION	MATERIAL	CTN QTY
D01030	3" extension only	-	CP Brass	1
D01031	4 3/4" extension only	-	CP Brass	1

Diverter Spout For Hand Held Shower- 1/2" MIP Hookup

PART NO.	DESCRIPTION	CONNECTION	MATERIAL	CTN QTY
D01010	3/4" x 1/2" FIP top hookup	Base	Zamak	10
D01011	3/4" x 1/2" MIP lower hookup	Base	Zamak	10

Chrome Plated Diverter Spout



- Longer length for today's larger tubs
- CTS unit comes with hex key

PART NO.	SIZE	CONNECTION	CTN QTY
D01024	7"	1/2" FIP Nose	25
D01025	7"	1/2" CTS Slide	25

Chrome Plated Slip-On Diverter Spout With Polished Brass Knob



- Hex key included
- Polished brass knob
- Standard 5 1/2" diverter spout
- 1/2" CTS slip-on connection with set screw

PART NO.	DESCRIPTION	CTN QTY
D01032	Slip-On Diverter Spout With PB Knob	1

Tub Spouts

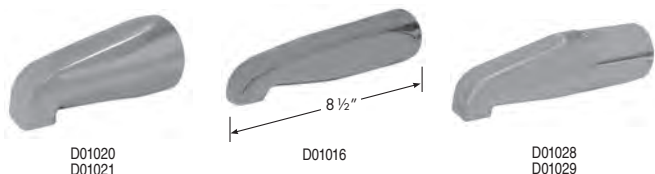

Chrome Plated Zamak Slide Connection With Hex Key

PART NO.	DESCRIPTION	CONNECTION	MATERIAL	CTN QTY
D01020	1/2" FIP	Nose	CP Zamak	10
D01021	1/2" CTS slide connection	Base	CP Zamak	10

8 1/2" One Piece Chrome Plated Brass

PART NO.	DESCRIPTION	CONNECTION	MATERIAL	CTN QTY
D01016	3/4" x 1/2" FIP	Base	CP brass	1

Two Piece Chrome Plated

PART NO.	DESCRIPTION	CONNECTION	MATERIAL	CTN QTY
D01028	8" two piece	Nose	Zamak	1
D01029	10" two piece	Nose	Zamak	1

Telescoping Tub Spouts



- 5 1/2" overall length
- Adjustment up to 1" to accommodate various rough-ins

PART NO.	DESCRIPTION	CTN QTY
D01022	1/2" x 3/4" tub spout	10
D01023	1/2" x 3/4" diverter spout	10

9" Chrome Plated Tub Spouts



- One piece design
- 1/2" nose connection
- Solid brass construction

PART NO.	DESCRIPTION	CTN QTY
D01017	9" CP brass diverter spout	1
D01018	9" CP brass tub spout	1

7" Chrome Plated Tub Spout



- CTS unit comes with hex key
- Longer length for today's larger tubs

PART NO.	SIZE	CONNECTION	CTN QTY
D01026	7"	1/2" FIP Nose	25
D01027	7"	1/2" CTS Slide	25

Tub Spout



Solid Brass Zinc

Solid brass

PART NO.	SIZE	CONNECTION	CTN QTY
D01005	3/4" x 1/2"	Base	10

Zinc

PART NO.	SIZE	CONNECTION	CTN QTY
D01035	1/2" x 3/4"	Base	25

Overflow Plates



- Chrome plated
- 2" screws
- UPC listed

PART NO.	DESCRIPTION	CTN QTY
T05012	One-hole with screw	25
T05013	Two-hole with screws	25
T05010	One-hole less screw	25
T05011	Two-hole less screw	25
T05021	1/4" x 2" chrome plated screw	25

Tub Trip Levers With Spring



- Chrome plated
- Coil-type spring
- 2" screws

PART NO.	DESCRIPTION	CTN QTY
T05002	Round trip lever less screws	25
T05003	Round trip lever with 2" screws	25
T05021	1/4" x 2" chrome plated screw	25

Face Plate Gasket And Shoe Gasket



PART NO.	DESCRIPTION	CTN QTY
T05025	Beveled face plate gasket 2 1/8" ID x 3 3/16" OD - 9/16"-3/16" thick	25
T05026	Shoe gasket 1 3/4" ID x 2 5/8" OD - 3/32" thick	25

Wraparound Sponge Rubber Face Plate Gasket



- Grips top elbow for easy installation

PART NO.	DESCRIPTION	CTN QTY
T05029	Wraparound sponge rubber face gasket	25

#15 Plumb Kit



- Stainless steel flange (S01041)
- 1/2" x 6" chrome plated brass shower arm (S01030)
- Chrome plated plastic shower head with brass ball (S01003)

PART NO.	DESCRIPTION	CTN QTY
S03220	#15 Plumb kit	1

#51 Plumb Kit



- Chrome plated flange with set screw (S01040)
- 1/2" x 6" chrome plated brass shower arm (S01030)
- Chrome plated die cast adjustable shower head (S01005)

PART NO.	DESCRIPTION	CTN QTY
S03222	#51 Plumb kit	1

Bathtub Protectors



- High impact plastic
- Fluted side walls and foam bottom
- CARTON QUANTITIES ONLY
- MOTOR FREIGHT (LTL) ONLY

For Steel Tubs

PART NO.	DESCRIPTION	CTN QTY
T10014	14" deep x 60" long x 30" wide	35

For Oval Tubs

PART NO.	DESCRIPTION	CTN QTY
T10016	16" deep x 60" long x 42" wide	25

For Cast Iron Tubs

PART NO.	DESCRIPTION	CTN QTY
T10216	16" deep x 60" long x 30" wide	35

Adapter Bushing For Bath Drain



- Brass bushing

PART NO.	DESCRIPTION	CTN QTY
T05023	Kohler Bushing	5
T05024	1 1/2" MIP x 1 3/8" FIP	5

Standard Waste And 1-Hole Overflow

Half Kit With Chrome Plated Lift And Turn



- 2-hole test kit converts to one hole face plate

PART NO.	DESCRIPTION	CTN QTY
B07220T	Waste and overflow kit- PVC	1
B07221T	Waste and overflow kit- ABS	1

Standard Waste And 2-Hole Overflow

Half Kit With Satin Nickel Lift And Turn



- 2-hole face plate

PART NO.	DESCRIPTION	CTN QTY
B07111S	Waste and Overflow kit- ABS	1
B07114S	Waste and Overflow kit- PVC	1

Standard Waste And Overflow

Full Kit With Chrome Plated Friction Lift



- Includes bar
- 1-hole face plate

PART NO.	DESCRIPTION	CTN QTY
B07219	Waste and overflow Kit- PVC	24

Lift And Turn Bath Drain



- Chrome plated
- 2 11/16" OD flange

PART NO.	DESCRIPTION	CTN QTY
P35061	1 3/8" bath drain (1 5/8" thread OD) zinc body	1
P35060	1 1/2" bath drain (1 7/8" thread OD) zinc body	1
P35066	1 1/2" bath drain (1 7/8" thread OD) brass	1

Friction Lift Tub Drain



- Chrome plated zinc

PART NO.	DESCRIPTION	CTN QTY
P35067	1 1/2" bath drain	1
P35077	1 3/8" CP Friction Lift Tub Drain	1

Chrome Plated Grid Drain Body With Screw



- Chrome plated zinc

PART NO.	DESCRIPTION	CTN QTY
P35064	1 1/2" CP grid drain	1

Toe Touch Bath Drain



Bath Drain



CP Replacement Drain

- Chrome plated zinc

PART NO.	DESCRIPTION	CTN QTY
P35063	1 3/8" bath drain (1 5/8" thread OD)	1
P35062	1 1/2" bath drain (1 7/8" thread OD)	1
P35056	5/16" CP replacement cartridge	1
P35057	3/8" CP replacement cartridge	1

Roman Tub Drains



- Solid brass construction
- Screws are included
- U-shaped handle design
- Designed to fit D64 series "Code Blue" drains

PART NO.	DESCRIPTION	CTN QTY
D40000	CP Roman Tub Drain	1
D40001	PB/PVD Roman Tub Drain	1
D40002	Satin Nickel PVD Roman Tub Drain	1

Flip-It Conversion Kit



- No bending or stooping necessary to operate
- Open or close with a flip of the toe
- Fits most popular tub drains

PART NO.	DESCRIPTION	CTN QTY
P35170	Chrome plated Flip-It Conversion kit	1

Basin And Tub Stopper



- White hollow rubber with rustproof ring

PART NO.	TRADE SIZE	TOP	BOTTOM	CTN QTY
P35125	1 1/4"	1 3/8"	1 3/16"	25
P35150	1 1/2"	1 5/8"	1 3/8"	25
P35158	1 5/8"	1 25/32"	1 19/32"	25
P35175	1 3/4"	1 55/64"	1 11/16"	25

Fit-All Stopper



Part No.	Top	Bottom
P35-160	1 1/2"	7/8"
P35-161	3"	1 1/2"

- White rubber construction

PART NO.	DESCRIPTION	CTN QTY
P35160	1" - 1 3/8" basin stopper	10
P35161	1 1/2" - 2" bathtub or laundry tub stopper	10

Pop-Up Basin Stopper



P36002



P36003



P36004

PART NO.	DESCRIPTION	CTN QTY
P36002	Delta pop-up basin stopper	25
P36003	Price-Pfister pop-up stopper	25
P36004	Moen pop-up basin stopper	25

Flip-It Tub Stopper



- No tools needed for installation
- Open or close with a flip of the toe
- One piece construction of Derlin and ABS
- Fits most popular tub drains (assorted o-rings included)

PART NO.	DESCRIPTION	CTN QTY
P35070	Chrome plated Flip-it	12

Schedule 40 Bath Waste Kits - Expanded Views

*See pages B22 - B23 for a complete list of available Schedule 40 Bath Waste Kits

Standard **One-Hole** Schedule 40 Bath Waste Kits

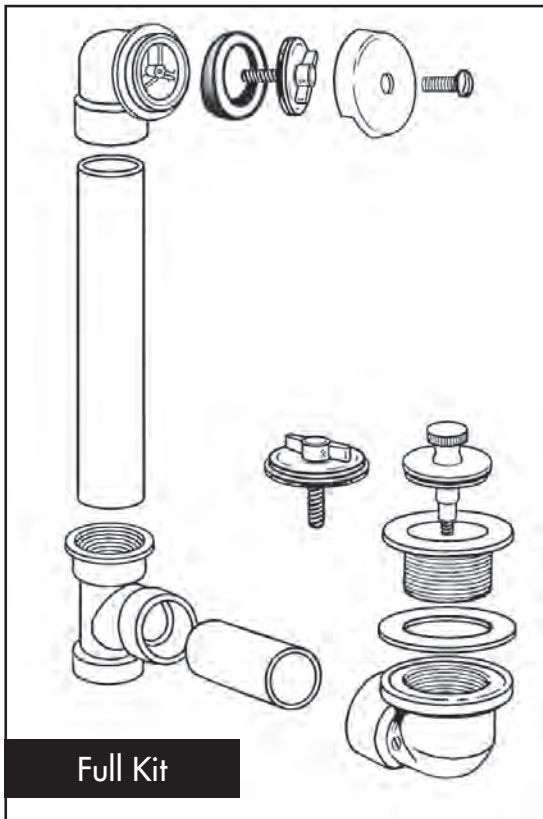

Full Kit

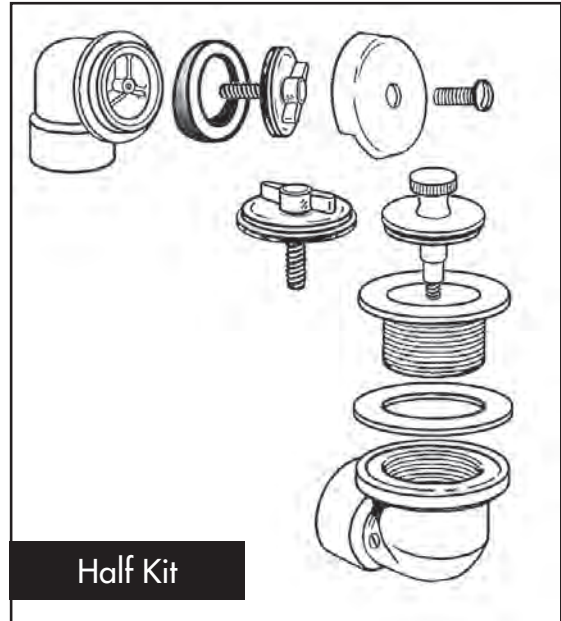

Half Kit

Standard **Two-Hole** Schedule 40 Bath Waste Kits

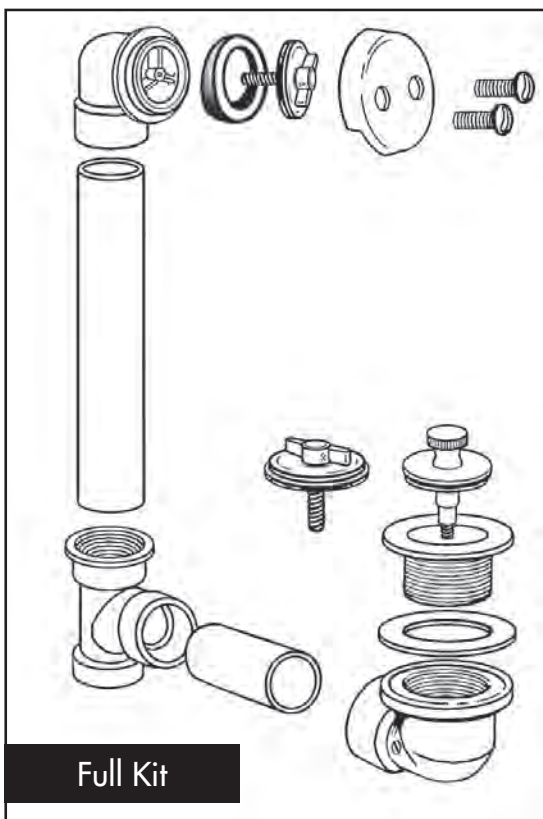

Full Kit



Half Kit

Schedule 40 Direct Waste Bath Kits

With One-Hole Face Plates

For use in apartments, motels, hotels - anywhere with back to back baths



T-Waste Kit Benefits:

- Direct access to trap from tub
- Direct waste much less likely to clog
- Solvent weld = homogeneous
- Code required for back to back installation
- Never needs access through walls or ceilings

- NO ACCESS PANEL NEEDED!
- UPC listed
- One-hole face plates
- Bolt holes on top elbows are pre-threaded
- All drains 3/8" thread size for testing

Note: Please use suffix "T" when ordering any waste and overflow kit to have test kit included. Add \$4.99 to list price. When a complete kit with a two-hole test kit is ordered, a one-hole face plate with aluminum conversion bar will be supplied.



Half Kit - Lift & Turn Drain



Half Kit - Toe Pop-Up Drain

T-Waste Half Kit- No Pipe Or Elbow

PART NO.	MATERIAL	DESCRIPTION	CTN QTY
B07038	PVC	CP brass lift and turn drain	24
B07001	PVC	CP lift and turn drain	24
B07005	PVC	PB lift and turn drain	24
B07003	PVC	CP toe pop-up drain	24
B07007	PVC	PB toe pop-up drain	24
B07040	PVC	CP friction lift drain	24
B07042	PVC	PB friction lift drain	24
B07006	ABS	PB lift and turn drain	24
B07039	ABS	CP brass lift and turn drain	24
B07002	ABS	CP lift and turn drain	24
B07004	ABS	CP toe pop-up drain	24
B07008	ABS	PB toe pop-up drain	24
B07041	ABS	CP friction lift drain	24
B07043	ABS	PB friction lift drain	24



Full Kit - Lift & Turn Drain



Full Kit - Toe Pop-Up Drain

T-Waste Full Kit- Includes Pipe And 90° Elbow

PART NO.	MATERIAL	DESCRIPTION	CTN QTY
B07044	PVC	CP brass lift and turn drain	24
B07020	PVC	CP lift and turn drain	24
B07024	PVS	PB lift and turn drain	24
B07022	PVC	CP toe pop-up drain	24
B07046	PVC	CP friction lift drain	24
B07048	PVC	PB friction lift drain	24
B07045	ABS	CP brass lift and turn drain	24
B07021	ABS	CP lift and turn drain	24
B07025	ABS	PB lift and turn drain	24
B07023	ABS	CP toe pop-up drain	24
B07027	ABS	PB toe pop-up drain	24
B07047	ABS	CP friction lift drain	24
B07049	ABS	PB friction lift drain	24

Schedule 40 Direct Waste Bath Kits

With Two-Hole Face Plates

For use in apartments, motels, hotels - anywhere with back to back baths



T-Waste Kit Benefits:

- Direct access to trap from tub
- Direct waste much less likely to clog
- Solvent weld = homogeneous
- Code required for back to back installation
- Never needs access through walls or ceilings

- NO ACCESS PANEL NEEDED!
- UPC listed
- Two-hole face plates
- Bolt holes on top elbow are pre-threaded
- All drains 3/8" thread size for testing

Note: Please use suffix "T" when ordering any waste and overflow kit to have test kit included. Add \$4.99 to list price. When a complete kit with a two-hole test kit is ordered, a one-hole face plate with aluminum conversion bar will be supplied.



Half Kit - Lift & Turn Drain



Half Kit - Toe Pop-Up Drain

T-Waste Half Kit- No Pipe Or Elbow

PART NO.	MATERIAL	DESCRIPTION	CTN QTY
B07138	PVC	CP brass lift and turn drain	24
B07101	PVC	CP lift and turn drain	24
B07105	PVC	PB lift and turn drain	24
B07103	PVC	CP toe pop-up drain	24
B07107	PVC	PB toe pop-up drain	24
B07140	PVC	CP friction lift drain	24
B07142	PVC	PB friction lift drain	24
B07139	ABS	CP brass lift and turn drain	24
B07102	ABS	CP lift and turn drain	24
B07106	ABS	PB lift and turn drain	24
B07104	ABS	CP toe pop-up drain	24
B07108	ABS	PB toe pop-up drain	24
B07141	ABS	CP friction lift drain	24
B07143	ABS	PB friction lift drain	24



Full Kit - Lift & Turn Drain



Full Kit - Toe Pop-Up Drain

T-Waste Full Kit- Includes Pipe And 90° Elbow

PART NO.	MATERIAL	DESCRIPTION	CTN QTY
B07144	PVC	CP brass lift and turn drain	24
B07120	PVC	CP lift and turn drain	24
B07124	PVC	PB lift and turn drain	24
B07122	PVC	CP toe pop-up drain	24
B07126	PVC	PB toe pop-up drain	24
B07146	PVC	CP friction lift drain	24
B07148	PVC	PB friction lift drain	24
B07121	ABS	CP lift and turn drain	24
B07125	ABS	PB lift and turn drain	24
B07123	ABS	CP toe pop-up drain	24
B07127	ABS	PB toe pop-up drain	24
B07147	ABS	CP friction lift drain	24
B07149	ABS	PB friction lift drain	24

Schedule 40 Bath Waste Kits

With One-Hole Face Plates



- UPC listed
- One-hole face plates
- Bolt holes on top elbows are pre-threaded
- All drains 3/8" thread size for testing

Note: Please use suffix "T" when ordering any waste and overflow kit to have test kit included. Add \$4.99 to list price. When a complete kit with a two-hole test kit is ordered, a one-hole face plate with aluminum conversion bar will be supplied.



Half Kit - Lift & Turn Drain

Half Kit - Toe Pop-Up Drain

Standard Half Kit- No Pipe Or Elbow

PART NO.	MATERIAL	DESCRIPTION	CTN QTY
B07050	PVC	CP brass lift and turn drain	24
B07010	PVC	CP lift and turn drain	24
B07014	PVC	PB lift and turn drain	24
B07012	PVC	CP toe pop-up drain	24
B07016	PVC	PB toe pop-up drain	24
B07052	PVC	CP friction lift drain	24
B07054	PVC	PB friction lift drain	24
B07051	ABS	CP brass lift and turn drain	24
B07011	ABS	CP lift and turn drain	24
B07015	ABS	PB lift and turn drain	24
B07013	ABS	CP toe pop-up drain	24
B07017	ABS	PB toe pop-up drain	24
B07053	ABS	CP friction lift drain	24
B07055	ABS	PB friction lift drain	24



Full Kit - Lift & Turn Drain

Full Kit - Toe Pop-Up Drain

Standard Full Kit- Includes Pipe And Tee PVC

PART NO.	MATERIAL	DESCRIPTION	CTN QTY
B07056	PVS	CP brass lift and turn drain	24
B07030	PVC	CP lift and turn drain	24
B07034	PVC	PB lift and turn drain	24
B07032	PVC	CP toe pop-up drain	24
B07036	PVC	PB toe pop-up drain	24
B07058	PVC	CP friction lift drain	24
B07060	PVC	PB friction lift drain	24
B07057	ABS	CP brass lift and turn drain	24
B07031	ABS	CP lift and turn drain	24
B07035	ABS	PB lift and turn drain	24
B07033	ABS	CP toe pop-up drain	24
B07037	ABS	PB toe pop-up drain	24
B07059	ABS	CP friction lift drain	24
B07061	ABS	PB friction lift drain	24

Schedule 40 Bath Waste Kits

With Two-Hole Face Plates



- UPC listed
- Two-hole face plates
- Bolt holes on top elbow are pre-threaded
- All drains 3/8" thread size for testing

Note: Please use suffix "T" when ordering any waste and overflow kit to have test kit included. Add \$4.99 to list price. When a complete kit with a two-hole test kit is ordered, a one-hole face plate with aluminum conversion bar will be supplied.



Half Kit - Lift & Turn Drain

Half Kit - Toe Pop-Up Drain

Standard Half Kit- No Pipe Or Tee

PART NO.	MATERIAL	DESCRIPTION	CTN QTY
B07150	PVC	CP brass lift and turn drain	24
B07110	PVC	CP lift and turn drain	24
B07114	PVC	PB lift and turn drain	24
B07112	PVC	CP toe pop-up drain	24
B07116	PVC	PB toe pop-up drain	24
B07152	PVC	CP friction lift drain	24
B07154	PVC	PB friction lift drain	24
B07151	ABS	CP brass lift and turn drain	24
B07111	ABS	CP lift and turn drain	24
B07115	ABS	PB lift and turn drain	24
B07113	ABS	CP toe pop-up drain	24
B07117	ABS	PB toe pop-up drain	24
B07153	ABS	CP friction lift drain	24
B07155	ABS	PB friction lift drain	24



Full Kit - Lift & Turn Drain

Full Kit - Toe Pop-Up Drain

Standard Full Kit- Includes Pipe Or Tee

PART NO.	MATERIAL	DESCRIPTION	CTN QTY
B07156	PVC	CP brass lift and turn drain	24
B07130	PVS	CP lift and turn drain	24
B07134	PVC	PB lift and turn drain	24
B07132	PVC	CP toe pop-up drain	24
B07136	PVC	PB toe pop-up drain	24
B07158	PVC	CP friction lift drain	24
B07160	PVC	PB friction lift drain	24
B07157	ABS	CP brass lift and turn drain	24
B07131	ABS	CP lift and turn drain	24
B07135	ABS	PB lift and turn drain	24
B07133	ABS	CP toe pop-up drain	24
B07137	ABS	PB toe pop-up drain	24
B07159	ABS	CP friction lift drain	24
B07161	ABS	PB friction lift drain	24

Waste And Overflow Test Kits



• Drain thread size is 3/8"

PART NO.	DESCRIPTION	CTN QTY
B07201	One-hole waste and overflow test kit	1
B07202	Two-hole waste and overflow test kit	1

Aluminum Bar For Waste And Overflow

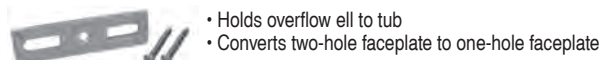

- Holds overflow ell to tub
- Converts two-hole faceplate to one-hole faceplate

PART NO.	DESCRIPTION	CTN QTY
B07200	Aluminum bar with 2 screws	1
B07203	One-hole overflow face plate with aluminum bar	1

Bath Waste Trim Kits



One-Hole

PART NO.	DESCRIPTION	CTN QTY
B07071	Overflow plate trim kit with CP lift and turn stopper	1
B07073	Overflow plate trim kit with CP friction lift stopper	1

Two-Hole

PART NO.	DESCRIPTION	CTN QTY
B07171	Overflow plate trim kit with CP lift and turn stopper	1
B07173	Overflow plate trim kit with CP friction lift stopper	1

One Hole Polished Brass Face Plate Trim Kit



- Overflow plate, screws and lift and turn stopper
- PVD finish

PART NO.	DESCRIPTION	CTN QTY
B08071	1 Hole PB face plate trim kit	1

Conversion Kits With Cross Bar



- Includes cross bar
- 1- Hole face plate
- 1 3/8" chrome plated zinc drain
- Includes bushing for 1 1/2" installation

PART NO.	DESCRIPTION	CTN QTY
B51019	CP lift and turn conversion kit	1
B51020	PB lift and turn conversion kit	1
B07210	CP friction lift conversion kit	1

Trip Lever Trim



- Trip lever overflow plate, screws and strainer

PART NO.	DESCRIPTION	CTN QTY
B51014	Chrome trip lever trim only	1

Trip Lever Conversion Kit



- Trip lever overflow plate, screws, strainer assembly and brass adapter

PART NO.	DESCRIPTION	CTN QTY
B51015	Chrome trip lever conversion kit	5

Bath Waste Conversion Kits



- Carded for display
- B51006, B51008, B51011 are 1 1/2" kits
- All others are 1 1/2"x 1 3/8" and include bushings

2-Hole Kits

PART NO.	DESCRIPTION	CTN QTY
B51005	CP lift and turn kit	1
B51006	White lift and turn kit	1
B51007	CP pop-up kit	1
B51008	CP friction lift kit	1

1-Hole Kits

PART NO.	DESCRIPTION	CTN QTY
B51009	CP lift and turn kit	1
B51010	CP pop-up kit	1
B51011	CP friction lift kit	1

Schedule 40 Bath Waste Rough-In Kits



One-Hole Rough In Kits B07070
*(Shown with Test Kit)

One-Hole

PART NO.	MATERIAL	DESCRIPTION	CTN QTY
B07074	PVC	Std. rough-in kit w/ CP lift & turn drain body	1
B07374	ABS	Std. rough-in kit w/ CP lift & turn drain body	1
B07075	PVC	Std. rough-in kit w/ CP friction lift drain body	1
B07375	ABS	Std. rough-in kit w/ CP friction lift drain body	1

Two-Hole

PART NO.	MATERIAL	DESCRIPTION	CTN QTY
B07076	PVC	Std. rough-in kit w/ CP lift & turn drain body	1
B07376	ABS	Std. rough-in kit w/ CP list & turn drain body	1
B07077	PVC	Std. rough-in kit w/ CP friction lift drain body	1
B07377	ABS	Std. rough-in kit w/ CP friction lift drain body	1

Schedule 40 Bath Waste Rough-In Kits With Test Kits



Two-Hole Rough In Kits B07170
*(Shown with Test Kit)

*One-Hole			
PART NO.	MATERIAL	DESCRIPTION	CTN QTY
B07070	PVC	Std. rough-in kit w/ CP lift & turn drain body & test kit	1
B07470	ABS	Std. rough-in kit w/ CP lift & turn drain body & test kit	1
B07072	PVC	Std. rough-in kit w/ CP friction lift drain body & test kit	1
B07472	ABS	Std. rough-in kit w/ CP friction lift drain body & test kit	1
*Two-Hole			
PART NO.	MATERIAL	DESCRIPTION	CTN QTY
B07170	PVC	Std. rough-in kit w/ CP lift & turn drain body & test kit	1
B07476	ABS	Std. rough-in kit w/ CP lift & turn drain body & test kit	1
B07172	PVC	Std. rough-in kit w/ CP friction lift drain body & test kit	1
B07477	ABS	Std. rough-in kit w/ CP friction lift drain body & test kit	1

Grab Bar With Exposed Flange



- 18 gauge stainless steel
- Meets 900 lb. downward pull when installed properly
- Meets federal specification WW-P-541/8B, Amendment 1, 16 April 1990
- Meets ANSI 117.1 and all ADA Code requirements
- Meets federal specifications for FHA, VA hospital, private construction
- Individually bagged with stainless steel mounting screws

Satin Finish		
PART NO.	DESCRIPTION	CTN QTY
G12012	1 1/4" x 12"	10
G12016	1 1/4" x 16"	10
G12018	1 1/4" x 18"	10
G12024	1 1/4" x 24"	10
G12030	1 1/4" x 30"	10
G12032	1 1/4" x 32"	10
G12036	1 1/4" x 36"	10
G12042	1 1/4" x 42"	5
G12048	1 1/4" x 48"	5
G13012	1 1/2" x 12"	10
G13016	1 1/2" x 16"	10
G13018	1 1/2" x 18"	10
G13024	1 1/2" x 24"	10
G13030	1 1/2" x 30"	10
G13032	1 1/2" x 32"	10
G13036	1 1/2" x 36"	10
G13042	1 1/2" x 42"	5
G13048	1 1/2" x 48"	5

Grab Bar With Exposed Flange (cont.)



- 18 gauge stainless steel
- Meets 900 lb. downward pull when installed properly
- Meets federal specification WW-P-541/8B, Amendment 1, 16 April 1990
- Meets ANSI 117.1 and all ADA Code requirements
- Meets federal specifications for FHA, VA hospital, private construction
- Individually bagged with stainless steel mounting screws

Peened Finish		
PART NO.	DESCRIPTION	CTN QTY
G12212	1 1/4" x 12"	10
G12216	1 1/4" x 16"	10
G12218	1 1/4" x 18"	10
G12224	1 1/4" x 24"	10
G12230	1 1/4" x 30"	10
G12232	1 1/4" x 32"	10
G12236	1 1/4" x 36"	10
G12242	1 1/4" x 42"	5
G12248	1 1/4" x 48"	5
G13212	1 1/2" x 12"	10
G13216	1 1/2" x 16"	10
G13218	1 1/2" x 18"	10
G13224	1 1/2" x 24"	10
G13230	1 1/2" x 30"	10
G13232	1 1/2" x 32"	10
G13236	1 1/2" x 36"	10
G13242	1 1/2" x 42"	5
G13248	1 1/2" x 48"	5

Grab Bar With Concealed Snap-On Flange



- 18 gauge stainless steel
- Meets 900 lb. downward pull when installed properly
- Meets federal specification WW-P-541/8B, Amendment 1, 16 April 1990
- Meets ANSI 117.1 and all ADA Code requirements
- Meets federal specifications for FHA, VA hospital, private construction
- Individually bagged with stainless steel mounting screws

Satin Finish		
PART NO.	DESCRIPTION	CTN QTY
G12112	1 1/4" x 12"	10
G12116	1 1/4" x 16"	10
G12118	1 1/4" x 18"	10
G12124	1 1/4" x 24"	10
G12130	1 1/4" x 30"	10
G12132	1 1/4" x 32"	10
G12136	1 1/4" x 36"	10
G12142	1 1/4" x 42"	5
G12148	1 1/4" x 48"	5
G13112	1 1/2" x 12"	10
G13116	1 1/2" x 16"	10
G13118	1 1/2" x 18"	10
G13124	1 1/2" x 24"	10
G13130	1 1/2" x 30"	10
G13132	1 1/2" x 32"	10
G13136	1 1/2" x 36"	10
G13142	1 1/2" x 42"	5
G13148	1 1/2" x 48"	5

Grab Bar With Concealed Snap-On Flange (cont.)



Satin Finish



Peened Finish

- 18 gauge stainless steel
- Meets 900 lb. downward pull when installed properly
- Meets federal specification WW-P-541/8B, Amendment 1, 16 April 1990
- Meets ANSI 117.1 and all ADA Code requirements
- Meets federal specifications for FHA, VA hospital, private construction
- Individually bagged with stainless steel mounting screws

Peened Finish

PART NO.	DESCRIPTION	CTN QTY
G12312	1 1/4" x 12"	10
G12316	1 1/4" x 16"	10
G12318	1 1/4" x 18"	10
G12324	1 1/4" x 24"	10
G12330	1 1/4" x 30"	10
G12332	1 1/4" x 32"	10
G12336	1 1/4" x 36"	10
G12342	1 1/4" x 42"	5
G12348	1 1/4" x 48"	5
G13312	1 1/2" x 12"	10
G13316	1 1/2" x 16"	10
G13318	1 1/2" x 18"	10
G13324	1 1/2" x 24"	10
G13330	1 1/2" x 30"	10
G13332	1 1/2" x 32"	10
G13336	1 1/2" x 36"	10
G13342	1 1/2" x 42"	5
G13348	1 1/2" x 48"	5

Grab Bar Fastening Systems



G12998



G12999



S02999

- G12998
- Made of stainless steel screws and fire retardant plastic
 - Installs in minutes in any wall
 - Will hold up to 600 lbs. per grab bar

- G12999
- Made of stainless steel
 - Will hold up to 1000 lbs. per grab bar
 - Blocking/studs are not required

- S02999
- Will not be visible when installed
 - Prevents shower rod sag
 - Will not loosen over time

PART NO.	DESCRIPTION	CTN QTY
G12998	Residential Grab Bar Wing It	1
G12999	Commercial Grab Bar Wing It	1
S02999	Crescent Rod Wing It	1

Brass Pop-up Assembly/Replacement Parts

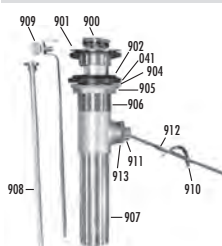

P35041



P35902

- All metal construction
- Tool free locknut and ballrod nut
- 17 gauge

PART NO.	DESCRIPTION	CTN QTY
P35001	Chrome-brass	25

Replacement Parts

PART NO.	DESCRIPTION	CTN QTY
P35041	1 1/4" Mack Gasket	25
P35900	Universal plastic plunger with CP brass cap	25
P35901	CP brass flange	25
P35902	Flat rubber washer	25
P35904	Polyethylene washer	25
P35905	Brass locknut	25
P35906	CP brass drain body	25
P35907	CP brass tailpiece	25
P35908	Brass lift rod	25
P35909	Steel clevis with thumb screw	25
P35910	Stainless steel spring clip	25
P35911	CP brass ball nut	25
P35912	CP steel ball rod with plastic all (6 3/8" long)	25
P35913	Friction washer- under nut (not visible)	25

Lift & Lock Pop-Up



P35000



P35003

- Chrome plated

With overflow holes

PART NO.	DESCRIPTION	CTN QTY
P35000	CP Lift & Lock pop-up w/ overflow holes	1

Without overflow holes

PART NO.	DESCRIPTION	CTN QTY
P35003	CP Lift & Lock pop-up w/o overflow holes	1

ABS Pop-Up Assembly



- Carded

PART NO.	DESCRIPTION	CTN QTY
P35004	Grey plastic	1

Chrome Plated ABS Pop-Up Assembly



- Carded

PART NO.	DESCRIPTION	CTN QTY
P35005	Chrome plated plastic	1

Brass P.O. Plug Drain



- With chain and stopper

PART NO.	DESCRIPTION	CTN QTY
D70103	1 1/4" P.O. plug drain	1

Trap Primer Tailpiece



T74010



T74011

- 17 gauge tubular chrome plated steel
- Sturdy one-piece construction eliminates leaks and crossthreading

PART NO.	DESCRIPTION	CTN QTY
T74010	1 1/4" x 8" - threaded top	1
T74011	1 1/2" x 8" - slip joint top direct connection	1

Commercial P-Trap with Cleanout



- Carded
- Brass nuts
- Chrome plated
- 17 gauge semi-cast P-trap
- 17 gauge tubular wall bend

PART NO.	DESCRIPTION	CTN QTY
J37124	1 1/4" OD with cleanout	1
J37150	1 1/2" OD with cleanout	1

Chrome Plated PVC P-Trap



- Complete with nuts, washers and escutcheon

PART NO.	DESCRIPTION	CTN QTY
P36102	1 1/4"	1
P36103	1 1/2"	1

Handicap Style Lav Drain



- Twin 90° construction
- Polished chrome plated brass
- Mack washer and brass locknut
- 17 gauge 1 1/4" tailpiece; cast brass elbows

PART NO.	DESCRIPTION	CTN QTY
D70101	Handicap drain	1
D70104	One piece tubular elbow	1

Commercial Handicap Drain With Elbow



- 1 1/4" female thread
- Complete with gaskets and brass locknut
- Polished chrome plated brass; cast brass elbow

PART NO.	DESCRIPTION	CTN QTY
D70102	Handicap drain with elbow	1

Commercial Grid Drain Without Overflow Holes



- 17 gauge
- For vessel sinks

PART NO.	DESCRIPTION	CTN QTY
D70105	CP grid drain	25

Commercial Lav Drain



- Polished chrome plated brass
- Mack washer and brass locknut
- 17 gauge 1 1/4" tailpiece; 6" long

PART NO.	DESCRIPTION	CTN QTY
D70100	Commercial lav drain	25

Flush Valve Pipe Support



- 1 1/2" OD size
- 5" center of pipe to wall
- Chrome plated split ring type
- Mounting hardware included

PART NO.	DESCRIPTION	CTN QTY
F39800	1 1/2" x 5" pipe support	1
F39700	1 1/2" x 3 1/2" pipe support	1

Bead Chain And Coupling



Spool Beaded Chain



A-Type Coupling



B-Type Coupling

- #10 size
- Nickel plated brass

PART NO.	DESCRIPTION	CTN QTY
P35021	100' spool beaded chain	4
P35022	250' spool beaded chain	2
P35023	500' spool beaded chain	1
P35025	A- type coupling	100
P35026	B- type coupling	100

Tissue Rollers

- CARTON QUANTITIES ONLY



PART NO.	DESCRIPTION	CTN QTY
B10195	Fit-All white plastic	25

Provent



- Manufactured housing and RV's only
- Automatic anti-siphon trap vent used as secondary venting
- Must be located at least 60" above trap arm
- Two individually protected fixtures may be connected to same 1 1/2" drain
- Three or more fixtures must be drained by 2" line
- Simply hand tighten, no thread seal needed
- Water closet must have main stack to outside
- Must be installed in accessible location with free flow air
- Do not install in sealed wall cavity
- 1 1/2" MPT threads

PART NO.	DESCRIPTION	CTN QTY
P21150	1 1/2" Provent	50

Air Gap



- Prevents sewage backflow by breaking siphoning action in drain line
- White polypro body with chrome plated ABS top
- UPC approved

PART NO.	DESCRIPTION	CTN QTY
A10001	Air Gap	50

Air Gap Spacer



PART NO.	DESCRIPTION	CTN QTY
A10901	Air gap spacer	25

Air Gap Dishwasher Kit



- Contains air gap, 24" dishwasher hose (7/8"), and two gear clamps
- Poly bagged and labeled

PART NO.	DESCRIPTION	CTN QTY
A10100	Air gap installation pack	1
A10200	Air gap installation pack-white	1
A10150	Air gap deluxe pack (includes dishwasher elbow and vacuum breaker)	1

Plumb Aire Air Vent



- Up to 160 fixture units
- May be exposed to temperatures ranging from -40 ° + 150°F
- No protective cover required when installed per code specifications
- Back pressure rated to 20 PSI

PVC

PART NO.	DESCRIPTION	CTN QTY
P21100	Plumb Aire vent- 1 1/2"x 2"	50
P21101	Plumb Aire vent with adapter	50

ABS

PART NO.	DESCRIPTION	CTN QTY
P21102	Plumb Aire vent - 1 1/2"x 2"	50
P21103	Plumb Aire vent with adapter	50

PVC Adapter For Air Inlet Valve

PART NO.	DESCRIPTION	CTN QTY
P21104	PVC adapter for air inlet valve	50
P21107	ABS adapter for air inlet valve	50

Rosettes



• CARTON QUANTITIES ONLY

PART NO.	DESCRIPTION	CTN QTY
B10110	Shallow pattern (zinc plated)	25
B10111	Deep pattern (zinc plated)	25

Basin Cock Locknut



• CARTON QUANTITIES ONLY

PART NO.	DESCRIPTION	CTN QTY
B10080	1/2"- 14 hex locknut	25
B10081	1/2"- 14 flanged hex locknut	25

Basket Strainer Locknuts & Washers



Locknut

Rubber Washer

Friction Washer

- Die cast zinc
- CARTON QUANTITIES ONLY

PART NO.	DESCRIPTION	CTN QTY
B10090	1 1/2" locknut	25
B10091	2" locknut	25
B10092	3 3/8" locknut for 4" duo strainer	25
B10093	3 3/8" heavy pattern locknut for 4" duo strainer	25
B10094	Basket strainer rubber washer (4 7/16" OD)	25

Fiber Friction Washer

PART NO.	DESCRIPTION	CTN QTY
D02002	Basket strainer friction washer (4 3/16" OD) [Fiber Friction Washer]	25

Ballcock Coupling Nut And Locknut



• CARTON QUANTITIES ONLY

PART NO.	DESCRIPTION	CTN QTY
C05080	5/8" x 1 1/2" 7 threads zinc die cast	25
C05081	5/8" x 7/8" brass	25
C05082	15/16"- 14 locknut	25

Plastic Slip Joint Nut



- White
- CARTON QUANTITIES ONLY (T85125 and T85150)

PART NO.	DESCRIPTION	CTN QTY
T83150	1 1/2" with wings	100
T85125	1 1/4" x 1 1/4"	100
T85150	1 1/2" x 1 1/2"	100

Basin Nut



• CARTON QUANTITIES ONLY

PART NO.	DESCRIPTION	CTN QTY
B10100	1/2" - 14 x 3/8" regular Zamak	25
B10102	1/2" - 14 x 1/2" regular Zamak	25
B10103	1/2" - 14 x 9/16" regular Zamak	25
B10104	1/2" - 14 x 9/16" regular brass	25

Plastic Lavatory Supply Nut



• Wing nut design
• CARTON QUANTITIES ONLY

PART NO.	DESCRIPTION	CTN QTY
B10105	1/2" - 14 x 1/2" white faucet nut	25

Sink Connection Washer



PART NO.	DESCRIPTION	CTN QTY
T79000	1 3/4" x 1 3/8" x 1/8"	100

Split Nut



• Replace fractured or stripped slip nuts without tubular disassembly
• Supplied with washer

PART NO.	DESCRIPTION	CTN QTY
T82125	1 1/4" split nut	100
T82150	1 1/2" split nut	100

Slip Joint Nut



• CARTON QUANTITIES ONLY

Die Cast Zinc

PART NO.	IPS x SLIP TUBE	CTN QTY
T77125	1 1/4" x 1 1/4"	25
T77138	1 1/2" x 1 3/8"	25
T77150	1 1/2" x 1 1/2"	25
T77151	1 1/2" x 1 1/4"	25
T77152	2" x 1 1/2"	25
T77200	2" x 2"	25

Chrome Plated Brass

PART NO.	IPS x SLIP TUBE	CTN QTY
T78125	1 1/4" x 1 1/4"	25
T78150	1 1/2" x 1 1/2"	25
T78151	1 1/2" x 1 1/4"	25
T78152	2" x 1 1/2"	25
T78200	2" x 2"	25

Rough Brass Slip Joint Nut



• Heavy cast brass
• CARTON QUANTITIES ONLY

PART NO.	IPS x SLIP TUBE	CTN QTY
T84125	1 1/4" x 1 1/4"	25
T84150	1 1/2" x 1 1/2"	25
T84151	1 1/2" x 1 1/4"	25
T84200	2" x 2"	25

Slip Joint Washer



• CARTON QUANTITIES ONLY

Square Cut Rubber

Poly Beveled

Square Cut Rubber

PART NO.	NUT x TUBE	CTN QTY
T79125	1 1/4" x 1 1/4"	100
T79150	1 1/2" x 1 1/2"	100
T79151	1 1/2" x 1 1/4"	100
T79200	2" x 2"	100
T79201	2" x 1 1/2"	100

Poly Beveled

PART NO.	NUT x TUBE	CTN QTY
T80125	1 1/4" x 1 1/4"	100
T80150	1 1/2" x 1 1/2"	100
T80151	1 1/2" x 1 1/4"	100
T80200	2" x 2"	100

Slip Joint Nut And Washer



• Chrome plated nut packed with square cut rubber washer
• CARTON QUANTITIES ONLY

Die Cast Nut

Brass Nut

Die Cast Nut

PART NO.	DESCRIPTION	CTN QTY
T77014	1 1/4" x 1 1/4"	25
T77012	1 1/2" x 1 1/2"	25
T77013	1 1/2" x 1 1/4"	25
T77020	2" x 2"	25

Brass Nut

PART NO.	DESCRIPTION	CTN QTY
T78014	1 1/4" x 1 1/4"	25
T78012	1 1/2" x 1 1/2"	25
T78013	1 1/2" x 1 1/4"	25
T78020	2" x 2"	25

Cone Slip Joint Washer



T85052



T85053

- Black
- CARTON QUANTITIES ONLY



T85054



T85055

PART NO.	NUT	TUBE	OD x ID	CTN QTY
T85050	1/2"	3/8"	23/32" x 3/8"	100
T85051	1/2"	3/8" threaded	23/32" x 3/8"	100
T85052	1/2"	7/16" or 1/2"	5/8" x 7/16"	100
T85053	Ballcock supply	-	3/4" x 7/16"	100
T85054	Ballcock supply	-	13/16" x 11/32"	100
T85055	Upper bath supply	-	27/32" x 7/16"	100

Home Washer Kit



- Screws and washers for faucet repair

PART NO.	DESCRIPTION	CTN QTY
J40155	Home washer kit	1

Brass Friction Rings



- CARTON QUANTITIES ONLY (T85-125 and T85-150)

PART NO.	NUT	TUBE	OD x ID	CTN QTY
T86050	1/2"	3/8"	21/32" x 25/64"	100
T86052	1/2"	7/16"	21/32" x 29/64"	100
T86053	Ballcock	1/2"	13/16" x 17/32"	100
T86054	Ballcock	3/8"	13/16" x 25/64"	100
T86055	Ballcock	7/16"	13/16" x 15/32"	100

Flanged Poly Tailpiece Washer



- CARTON QUANTITIES ONLY

PART NO.	NUT x TUBE	CTN QTY
T81150	1 1/2" x 1 1/2"	100
T79152	1 1/2" x 1 1/4" cloth inserted	100

Waste Connector



FIP x SLIP



MIP x SLIP



Brass Compression Ring

- Brass body ferrule and nut
- MIP units are combination female sweat

FIP x SLIP		
PART NO.	DESCRIPTION	CTN QTY
T75125	1 1/4" FIP x 1 1/4" OD	10
T75150	1 1/2" FIP x 1 1/2" OD	10
T75151	1 1/2" FIP x 1 1/4" OD	10
T75250	1 1/2" FIP x 1 1/2" OD with poly washer	10

MIP x SLIP		
PART NO.	DESCRIPTION	CTN QTY
T76125	1 1/4" MIP x 1 1/4" OD	10
T76150	1 1/2" MIP x 1 1/2" OD	10
T76151	1 1/2" MIP x 1 1/4" OD	10
T76250	1 1/2" MIP x 1 1/2" OD with poly washer	10

Brass Compression Ring		
PART NO.	DESCRIPTION	CTN QTY
T75000	1 1/4" OD	1
T75001	1 1/2" OD	1

Double Slip Fittings



Coupling



90° Ell



45° Ell

- Chrome plated brass
- 22 gauge

PART NO.	DESCRIPTION	CTN QTY
T74001	1 1/4" Coupling	25
T74002	1 1/2" Coupling	25
T74003	1 1/4" 90° Ell	50
T74004	1 1/2" 90° Ell	50
T74005	1 1/4" 45° Ell	25
T74006	1 1/2" 45° Ell	50

Slip Joint Tee



- Chrome plated satin finish cast brass
- Compression ends

PART NO.	DESCRIPTION	CTN QTY
C74105	1 1/2" x 1 1/2" x 1 1/2" tee	1

90° Drop Ear Elbow



• Cast brass

PART NO.	DESCRIPTION	CTN QTY
B55000	1/2" FIP x 1/2" FSWT	50
B55100	1/2" FIP x 1/2" FIP	45
B55103	1/2" FSWT x 1/2" FSWT	50
LEAD FREE		
PART NO.	DESCRIPTION	CTN QTY
B55050	1/2" FIP x 1/2" FSWT	50

90° Drop Ear Elbow



• Cast brass

PART NO.	DESCRIPTION	CTN QTY
B55104	3/4" FIP x 3/4" FSWT	1

90° Drop Ear Transition Elbow



• Cast brass
• Fits CPVC connection
• Permanent joint

PART NO.	DESCRIPTION	CTN QTY
B55101	1/2" FIP x 1/2" CPVC socket	25

Sweat Male Adapter/Marvel Rings



Sweat Male Adapter



Marvel Adapter

• Use on tub spout ell or closet/urinal stub out adapter

Sweat Male Adapter		
PART NO.	FSWT x MIP	CTN QTY
B55001	1/2" x 1/2"	5
B55002	3/4" x 3/4"	5
B55003	1" SJ x 1" SWT	5
Marvel Adapter		
PART NO.	FSWT x MIP	CTN QTY
B55004	1 1/4" SJ x 1 1/4" SWT	5
B55005	1 1/2" SJ x 1 1/2" SWT	5
B55006	2" SJ x 2" SWT	5
B55007	1 1/2" SJ x 1 1/4" SWT	5
B55008	1 1/2" SJ x 1 1/2" Tubular	5
B55009	1 1/4" SJ x 1 1/4" Tubular	5

Assorted Washer Kit



• 210 pieces packaged in reusable plastic case
• Available with flat or beveled washers
• Contains: 40-00, 40-0, 40-1/4, 30-1/4 large, 20-3/8, 20-3/8 medium, 10-3/8 large, 10-1/2 large

PART NO.	DESCRIPTION	CTN QTY
J40150	Beveled washer kit	1
J40151	Flat washer kit	1

O-Ring Kit And Pick

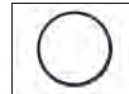

O25199

O25200

• Packed in resealable plastic case with fitting chart on lid
• Manufactured from nitrile compound
• Made in the USA

PART NO.	DESCRIPTION	CTN QTY
O25200	200 pc plumber's pack	1
O25199	O-ring pick	10

Solid Brass Bibb Screw Assortment Kit



• 208 pieces packaged in reusable plastic case
• Contains: 3/8" x 6-32, 1/2" x 6-32, 3/8" x 8-32, 1/2" x 8-32, 3/8" x 10-24, 1/2" x 6-24, 3/8" x 10-32, 1/2" x 10-32

PART NO.	DESCRIPTION	CTN QTY
J40153	Bibb screw assortment	1

Faucet Seat Kit



• Made in USA
• Reusable compartment box with seat guide on inside cover
• Kit B40000 contains all 36 seats
• Kit B40101 contains: B40002, B40005, B40006, B40015, B40020, B40028

MADE IN THE USA

PART NO.	DESCRIPTION	CTN QTY
B40000	144-piece faucet seat kit (36 different parts)	1
B40101	60-piece faucet seat kit (6 different parts)	1

Faucet Seats

- All brass
- Made in the USA

MADE IN THE
USA



PART NO.	FITS BRAND/SIZE	CTN QTY
B40001	Speakman 9/16" x 28 x 3/8"	5
B40003	Speakman 7/16" x 27 x 11/32"	5
B40002	American Standard 7/16" x 24 x 13/32"	5
B40004	American Standard 9/16" x 24" x 3/8"	5
B40012	American Standard 1/2" x 20 x 3/8"	5
B40013	American Standard 1/2" x 20 x 7/16"	5
B40021	American Standard 9/16" x 18 x 3/8"	5
B40031	American Standard 1/2" x 20 x 5/8"	5
B40005	Price Pfister 1/2" x 20" x 3/8"	5
B40006	Price Pfister .65" x 18 x 3/8"	5
B40007	Briggs, RPCL 1/2" x 24 x 7/16"	5
B40008	Briggs, RPCL 9/16" x 20 x 3/8"	5
B40023	Briggs 5/8" x 20 x 13/16"	5
B40035	Briggs, Republic 5/8" x 24 x 7/16"	5
B40009	Repal 9/16" x 28 x 11/32"	5
B40010	Eljer 1/2" x 27 x 1/2"	5
B40026	Eljer 1/2" x 20 x 3/8"	5
B40011	Kohler 1/2" x 27 x 3/8"	5
B40028	Kohler 1/2" x 27 x .318"	5
B40027	Kohler Push-In x .348"	5
B40014	Central Brass 9/16" x 27 x 13/32"	5
B40018	Central Brass 1/2" x 24 x .418"	5
B40019	Central Brass 5/8" x 24 x 23/32"	5
B40015	Sterling 1/2" x 24 x 3/8"	5
B40017	Universal 17/32" x 24 x 3/8"	5
B40020	Gerber 5/8" x 20 x 27/64"	5
B40024	Dick Brothers 1/2" x 27 x 13/32"	5
B40025	Indiana Brass 1/2" x 27 x 13/32"	5
B40034	Indiana Brass 9/16" x 27 x 5/8"	5
B40030	Union Brass 5/8" x 18 x 5/16"	5
B40033	Union Brass 5/8" x 18 x 29/32"	5
B40032	Sayco 1/2" x 20 x 5/16"	5
B40036	Steamway 1/2" x 24 x 11/32"	5

Cock Hole Cover



- Stainless steel
- CARTON QUANTITIES ONLY

PART NO.	DESCRIPTION	CTN QTY
B10201	1 3/4" OD with washer	25
B10202	2" OD with washer	25
B10200	1 1/2" snap in	25

Plastic Faucet Hole Cover



- 1 3/4" OD
- Push-in style/ white plastic
- CARTON QUANTITIES ONLY

PART NO.	DESCRIPTION	CTN QTY
B10203	1 3/4" OD	25

Porcelain And Handicap Faucet Handles

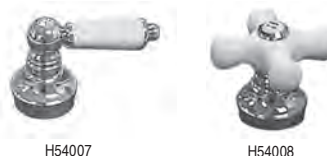

- Available in cross handle, lever handle and wrist blade styles
- Features Hot and Cold buttons
- Universal Fit
- 7/16", 9/16" and 5/8" heights
- Celcon and brass insert adapters
- Chrome plated finish

PART NO.	DESCRIPTION	CTN QTY
H54007	Lever faucet handle (each)	1
H54008	Cross faucet handle (each)	1

Long Reach Bar Tap Faucet



- 1/4" connection
- 10" meets NSF 61.9

PART NO.	DESCRIPTION	CTN QTY
B45014	Long reach bar tap faucet	6

Bar Tap Faucet



- Meets NSF standard 61.9
- 1/4" compression inlet connection
- Chrome plated brass faucets individually bagged
- Kit includes: stem, spring, 2 "o" rings and black handle

PART NO.	DESCRIPTION	CTN QTY
B45010	1/4" connection	6

Kitchen Hose And Spray (Fit All)



K52001



K52002

- Reinforced hose with universal coupling adapter
- Individually boxed for display
- Automatic off
- Replacement for thumb controlled sink spray



K52004



K52010

PART NO.	DESCRIPTION	CTN QTY
K52001	Head only	10
K52002	Head, hose and adapter	10
K52003	4' hose and adapter	10
K52004	Hose guide	10
K52010	White hose and spray	10
K52005	White head only	10

Rinse-Quik Hose And Spray



Complete Spray Head Assembly



Spray Head



Pet Sprayer

- Made in the USA
- Individually boxed

PART NO.	DESCRIPTION	RQ #	CTN QTY
K53001	Black spray assembly complete	(MR4224)	172
K53005	White spray assembly complete	(MR-4224WH)	172
K53006	Black spray assembly with 1/4" female swivel nut to fit Delta faucet	(MR422-4C)	172
K53002	Black spray head only w/ chrome ring	(MR4-22)	172
K53003	4' hose only	(MR-4)	172
K53004	Hose guide	(MR-200)	1100
K53007	Replacement hose for Delta	(MR4C)	1272
K53008	White spray head only w/ chrome ring	(MR422WH)	1272
K53056	Black spray head with black ring	(MR427)	172
K53057	White spray head assembly	(MR4274WH)	172
K53058	White spray head with white ring	(MR427WH)	172
K53055	Black spray head assembly	(MR42474)	172
K53077	Black spray head assembly with 6' hose	-	172
K53060	Pet Sprayer	(MR421)	172

Delta Style Spray Assembly



K55006



K55007

- 4' hose and 1/4" female swivel nut
- Replaces Delta style thumb-controlled sink sprays and hoses

PART NO.	DESCRIPTION	CTN QTY
K55006	Spray assembly	10
K55007	Replacement hose only	10

Chrome Plated Soap And Lotion Dispenser



- All brass pump
- Large 7 oz. capacity bottle

PART NO.	DESCRIPTION	CTN QTY
S08020	Chrome plated dispenser	1

Sink Lugs



S58050



S58052

- Four lugs bagged with screws
- PRICED PER BAG



S58051



S58053

PART NO.	DESCRIPTION	CTN QTY
S58050	Combo clip for counters 5/8" - 1 1/8" thick	1
S58052	E-lug for counters 3/8" - 1/2" thick	1
S58051	Adjustable clips for counters 3/4"-2 3/4" thick	1
S58053	KT lug with bolt	1

Undermount Sink Installation Kit



- Includes 4 each brackets, brass inserts, washers, bolts and wing nuts
- PRICED PER BAG

PART NO.	DESCRIPTION	CTN QTY
S58101	Undermount Kit	1

Lavatory Legs



- Fits vitreous china, steel or cast iron lavatories
- Sold in pairs

Total length ranges from 31 1/2" - 32 3/4" extended

PART NO.	DESCRIPTION	CTN QTY
L65001	27" legs	10

Lavatory And Sink Hangers



L56020



L56026



L56021



L56022



L56023



L56024



L56025

• Wall mount

PART NO.	DESCRIPTION	CTN QTY
L56020	Cast iron (for cast iron or vitreous china)	24
L56026	Pair cast iron hangers (for cast iron or vitreous china)	12
L56021	3-way steel (allows mounting in 3 directions)	24
L56022	Steel (for vitreous china)	24
L56023	Steel 10" centers (one piece)	12
L56024	7" stamped steel lavatory hanger	25
L56025	3-way steel lavatory bracket pair	1 pair

Adjustable Lavatory Hanger



- Durable cast iron
- Adjusts from 10 1/2" to 16"
- For iron, lugs fit into pockets
- For china, remove side lugs

PART NO.	DESCRIPTION	CTN QTY
L56027	Lav Hanger	1

Economy Replacement Basket Strainer



- ABS post
- Stainless steel basket

PART NO.	DESCRIPTION	CTN QTY
B03015	Replacement basket	1

Fit-All Basket Strainer



- Stainless steel

PART NO.	DESCRIPTION	CTN QTY
B03010	Fit-All strainer	1

Duo Basket Strainer



- 4 1/2" diameter to fit 3 1/2" drilling
- All stainless steel with zinc locknut
- Basket with rolled edge

PART NO.	DESCRIPTION	CTN QTY
S14001	SS duo strainer	20

Flat Top Grid Strainer



- 4 1/2" diameter to fit 3 1/2" drilling
- All stainless steel with zinc locknut (less tailpiece)

PART NO.	DESCRIPTION	CTN QTY
S14002	Flat grid strainer	20

Snap Lock Basket Strainer



- 4 1/2" diameter to fit 3 1/2" drilling
- All stainless steel
- Ball bearing basket with rolled edge (less tailpiece)

PART NO.	DESCRIPTION	CTN QTY
S14005	Snap lock basket strainer with zinc locknut	20
S14010	Snap lock basket strainer with brass locknut	50

Shallow Cup Duo Basket Strainer



- 4 1/2" diameter to fit 3 1/2" drilling
- All stainless steel with zinc locknut
- Basket with rolled edge (less tailpiece)

PART NO.	DESCRIPTION	CTN QTY
S14006	Shallow cup duo strainer	20

CP Brass Duo Strainer



PART NO.	DESCRIPTION	CTN QTY
S14007	CP brass duo strainer	20
S14011	Replacement strainer	1

Twist And Lock Basket Strainer



- 4 1/2" diameter to fit 3 1/2" drilling
- All stainless steel with zinc locknut
- Screw-in basket (less tailpiece)

PART NO.	DESCRIPTION	CTN QTY
S14003	Twist and lock basket strainer	20
S14103	Twist and lock replacement basket	1

Deep Cup Basket Strainer



- 4 1/2" diameter to fit 3 1/2" drilling
- All stainless steel with zinc locknut
- Basket with rolled edge (less tailpiece)

PART NO.	DESCRIPTION	CTN QTY
S14004	Deep cup basket strainer	20

Quick Fit Stainless Steel Basket Strainer



- Minimizes installation time
- Triangle frame mounts to underside
- Fits virtually all sinks
- Durable stainless construction with brass nut
- For replacement basket use B03015

PART NO.	DESCRIPTION	CTN QTY
S14008	Basket Strainer	1

Chrome Plated Brass Duo Basket Strainer



- Chrome plated brass body with stainless steel basket
- Heavy Duty construction
- Neoprene stopper

PART NO.	DESCRIPTION	CTN QTY
S14250	CP brass duo basket strainer	50

Stainless Steel Duo Basket Strainer



- SS body and basket
- Polished inner cup
- Chrome plated zinc post and slip nut
- Heavy duty rubber gasket and zinc locknut

PART NO.	DESCRIPTION	CTN QTY
S14251	SS duo post style basket strainer	50

Stainless Steel Deep Cup Basket Strainer



- Stainless steel body and locknut
- Neoprene stopper
- Spring style snap-in basket

PART NO.	DESCRIPTION	CTN QTY
S14014	SS cup basket strainer	50

Stainless Steel Duo Basket Strainer



- Stainless steel body and locknut
- Neoprene stopper
- Spring style snap-in basket

PART NO.	DESCRIPTION	CTN QTY
S14606	SS duo basket strainer	50

ABS Body And Post Basket Strainer



- Plastic nut

PART NO.	DESCRIPTION	CTN QTY
S14030	ABS body and post basket strainer	1

Deep Junior Duo Basket Strainer



B02102



B02103

- For 2" and 2 1/2" deep outlets and bar sinks

PART NO.	DESCRIPTION	CTN QTY
B02102	2" deep basket strainer	1
B02103	Replacement strainer	1

Junior Duo Basket Strainer



B02050



B02049

- Stainless steel body and basket with die cast locknut; 1 1/2" threads
- Complete with washers
- Fits 1 3/4" bar sink

PART NO.	DESCRIPTION	CTN QTY
B02050	Junior duo strainer	1
B02049	Replacement basket	1

Flat Duplex Strainer



- Stainless steel body and strainer with die cast locknut
- Complete with washers
- Fits 1 1/2" bar sink

PART NO.	DESCRIPTION	CTN QTY
B02052	Flat duplex strainer	1

Cast Brass Beehive Urinal Strainer



- Chrome plated brass strainer and body
- Brass locknut
- 2" caulk connection

PART NO.	DESCRIPTION	CTN QTY
D45000	Cast brass beehive urinal strainer	1
D45001	Replacement top with screws for D45000	1

Flexible Hair Strainer



- Soft rubber flexible strainer fits neatly over drain

PART NO.	DESCRIPTION	CTN QTY
P35180	Flexible hair strainer	5

1" Brass Bar Plug



- Cast brass
- Includes ground seat plug

PART NO.	DESCRIPTION	CTN QTY
B02060	1" x 3"	1

Tray Plug



- Stainless steel body with die cast locknut
- Fits 1 1/2" bar sink
- Complete with washers and stoppers

PART NO.	DESCRIPTION	CTN QTY
B02051	Tray plug	1

In-Sink-Erator Rubber Hush Cushion



- Black

PART NO.	DESCRIPTION	CTN QTY
P35159	In-Sink-Erator	25

Kitchen Sink And Garbage Disposal Stopper



- Vinyl construction
- Flanged to fit all sizes

PART NO.	DESCRIPTION	CTN QTY
P35162	Sink stopper	5

Garbage Disposal Splash Guard



- Snap-fit reinforced ring
- Fits all disposal brands

PART NO.	DESCRIPTION	CTN QTY
P35163	Rubber fit-all	10

Three Prong Drain Protector



- Aluminum

PART NO.	DESCRIPTION	CTN QTY
D18062	1 5/8" drain protector	10
D18063	1 7/8" drain protector	10

Sink And Basin Crumb Cups



- Nickel plated brass

PART NO.	DESCRIPTION	CTN QTY
P35165	1 1/2" crumb cup with post	10
P35166	1" crumb cup	10
P35167	1 3/8" crumb cup	10

Slotted Full Flow Aerators



Male Thread



Female Thread



Dual Thread

- Chrome-plated brass
- Non-corrosive mixing chamber
- Individually bagged
- 4.5 gpm
- LEAD FREE

PART NO.	DESCRIPTION	CTN QTY
A01001	15/16"-27 male thread	25
A01002	55/64"-27 female thread	25
A01003	Dual threads (15/16"-27 male x 55/64"-27 female)	25

Slotted 2.2 GPM Flow Aerators



- NSF listed santoprene washer
- Meets ANSI A-112.18M
- Easily cleaned
- Individually bagged
- LEAD FREE

PART NO.	DESCRIPTION	CTN QTY
A01004	Dual threads (15/16"-27 male x 55/64"-27 female)	25

Non-Slotted Full Flow Aerators



Male Thread



Female Thread



Dual Thread

- Individually bagged
- 4.5 GPM
- LEAD FREE

PART NO.	DESCRIPTION	CTN QTY
A01005	15/16"-27 male thread	25
A01006	55/64"-27 female thread	25
A01007	13/16"-27 male thread	25
A01008	3/4"-27 female thread	25
A01010	Dual threads (15/16"-27 male x 55/64"-27 female)	25

Non-Slotted .5 GPM Aerators



- Individually bagged
- LEAD FREE

PART NO.	DESCRIPTION	CTN QTY
A01037	Dual thread (15/16"-27 male x 55/64"-27 female	25

Non-Slotted Reduced Flow Aerators



Male Thread



Female Thread



Dual Thread

- Meets ANSI A-112.18M
- Individually bagged
- LEAD FREE

PART NO.	DESCRIPTION	CTN QTY
A01011	15/16"-27 male thread 2.2 gpm	25
A01012	55/64"-27 female thread 2.2 gpm	25
A01013	Dual threads 2.2 gpm (15/16"-27 male x 55/64"-27 female)	25
A01050	Dual threads 2.0 gpm (15/16"-27 male x 55/64"-27 female)	25
A01051	Dual threads 1.5 gpm (15/16"-27 male x 55/64"-27 female)	25

Chicago Style Faucet Aerator



- Individually bagged
- LEAD FREE

PART NO.	DESCRIPTION	CTN QTY
A01062	Non-slotted full flow (55/64"-27 female thread)	1

Aerator Counter Display



Display

- Dual threads are 15/16"-27 male x 55/64"-27 female
- 24 tubes per display box, six aerators per tube
- 144 pieces per display; priced per display
- LEAD FREE

PART NO.	DESCRIPTION	CTN QTY
A01015	Slotted full flow (A01003)	144
A01016	Slotted 2.2 gpm (A01004)	144
A01017	Non-slotted full flow (A01010)	144
A01018	Non-slotted 2.2 gpm (A01013)	144
A01060	Non-slotted 2.0 gpm (A01050)	144
A01900	Slotted 2.2 Spring-Flo	144

Aerator Six Pack Tubes For Counter Display



- Dual threads are 15/16"-27 male x 55/64"-27 female
- Six aerators per tube; priced per display
- LEAD FREE

Six Aerators per Tube

PART NO.	DESCRIPTION	CTN QTY
A01020	Slotted full flow (A01003)	Tube of 6
A01021	Slotted 2.2 gpm (A01004)	Tube of 6
A01022	Non-slotted full flow (A01010)	Tube of 6
A01023	Non-slotted 2.2 gpm (A01013)	Tube of 6
A01061	Non-slotted 2.0 gpm (A01050)	Tube of 6
A01901	Slotted 2.2 Spring-Flo	Tube of 6

Snap Fitting



A01029



A01036

- Aerated

PART NO.	DESCRIPTION	CTN QTY
A01029	Dual thread (15/16"-27 male x 55/64"-27 female x aerated snap fitting)	1
A01036	Nonplated brass snap coupler x 3/4" GHT for use with A01029 as a Quick-Disconnect unit	1

Swivel Spray Aerator



- Individually bagged
- Brass coupling nut
- Unit reverts to non-splash mode when water is turned off

PART NO.	DESCRIPTION	CTN QTY
A01014	Dual thread (15/16"-27 male x 55/64"-27 female))	25

Vandal-Proof Aerators



Male



Female

- Special key wrench included
- Prevents unauthorized removal

PART NO.	DESCRIPTION	CTN QTY
A01024	15/16"-27 male full flow	1
A01025	55/64"-27 female full grow	1
A01026	15/16"-27 male 2.0 gpm	1
A01027	55/64"-27 female 2.0 gpm	1

Faucet Adapters



• These parts are not OEM

To Fit Delta*, American Standard* Style

PART NO.	DESCRIPTION	CTN QTY
A01030	CP brass 15/16"-27 male x 55/64"-27 male threads	1
A01031	Plastic 15/16"-27 male x 55/64"-27 male threads	1

To Fit Price Pfister, Kohler* Style

PART NO.	DESCRIPTION	CTN QTY
A01032	CP brass female 3/4"-27 x 55/64"-27 male threads	1

To Fit Kohler*, Union*, Savoy* Style

PART NO.	DESCRIPTION	CTN QTY
A01033	CP brass male 13/16"-27 x 55/64"-27 male threads	1
A01034	Plastic male 13/16"-27 x 55/64"-27 male threads	1

To Fit Chicago* Style

PART NO.	DESCRIPTION	CTN QTY
A01035	CP brass female 13/16"-24 x 55/64"-27 male threads	1

Faucet To Garden Hose Adapters



• Chrome plated brass

PART NO.	DESCRIPTION	CTN QTY
A01040	Dual threads 15/16"-27 male x 55/64"-27 female x 3/4" MGH	1
A01041	Dual threads 15/16"-27 male x 55/64"-27 female x 3/4" MGH and 55/64"-27 male	1

* The manufacturers' names are used only to describe whose products the replacement handles will fit. The products are not manufactured by those companies.

Fit All Replacement Handles



Cross Pattern

Lever Pattern

Acrylic

• Vise grip design allows units to fit all types of stems, including rounded
 • Each pair individually bagged

PART NO.	DESCRIPTION	CTN QTY
H54001	Cross pattern	5
H54002	Lever pattern	5
H54003	Acrylic	5

Delta* /Peerless* Replacement Handles



• New design
 • Includes button and screw

PART NO.	DESCRIPTION	CTN QTY
H54010	Single layer crystal handle for all lav faucets using 212* ball	5
H54011	Single layer crystal handle offset broach for tub and shower valves using 212* ball	5
H54012	Single layer crystal tub handle for Scald Guard*	5

Delex* /Peerless* Replacement Handles



• Includes button and screws

PART NO.	DESCRIPTION	CTN QTY
H54013	Two chrome plated canopy handles for center set	5
H54014	Two crystal handles for center set new style	5
H54015	Two crystal handles for wide spread lav and tub and shower valves	5

Mixet* Replacement Handles



• Includes screw

PART NO.	DESCRIPTION	CTN QTY
H54017	Clear outer handle (MRH-CLR*)	5
H54018	Clear inner handle (MTH-CLR*)	5

* The manufacturers' names are used only to describe whose products the replacement handles will fit. The products are not manufactured by those companies.

Valley* /Aqualine* /Eljer* /Sears* Replacement Handles



• New style crystal handle
 • Complete with button and screw

PART NO.	DESCRIPTION	CTN QTY
H54030	Crystal single handle	5

Moen* /Stanadyne* Replacement Handles



H54025



H54026



H54027



H54028



H54029

- Complete with button and screw
- Teardrop* replaces both round and Teardrop* handles

PART NO.	DESCRIPTION	CTN QTY
H54025	Crystal Teardrop* single lav handle shallow broach	5
H54026	Crystal Teardrop* single tub handle deep broach	5
H54027	Round crystal single lav handle shallow broach	5
H54028	Round crystal single tub handle deep broach	5
H54029	Chrome plated cap and cover for single handle kitchen faucet	5

Delta* /Peerless* Faucet Index Buttons



H54040



H54041

- Single handle models

PART NO.	DESCRIPTION	CTN QTY
H54040	Old style crystal button for lav and tub and shower valve 1" OD	5
H54041	New large style crystal button for lav and tub and shower valve 1 1/2" OD	5

Moen* /Stanadyne* Single Handle Replacement Buttons



H54060



H54061

PART NO.	DESCRIPTION	CTN QTY
H54060	Button for new style Teardrop* crystal handle	5
H54061	Button for round crystal handle lav and tub and shower valve	5

* The manufacturers' names are used only to describe whose products the replacement handles will fit. The products are not manufactured by those companies.

Sure Grip Escutcheons



Low Pattern



Box Pattern



Bell Pattern

- Chrome plated steel
- CARTON QUANTITIES ONLY

Low-Pattern- Copper Tube Size			
PART NO.	SIZE	FLANGE OD	CTN QTY
E01375	3/8" (1/2" OD)	2 1/2"	25
E01050	1/2" (5/8" OD)	2 1/2"	25
E01075	3/4" (7/8" OD)	2 1/2"	25
E01100	1" (1 1/8" OD)	2 7/8"	25
E01125	1 1/4" (1 3/8" OD)	2 7/8"	25
E01150	1 1/2" (1 5/8" OD)	2 7/8"	25

Low-Pattern- Iron Pipe Size			
PART NO.	SIZE	FLANGE OD	CTN QTY
E02375	3/8"	2 1/2"	25
E02050	1/2"	2 1/2"	25
E02075	3/4"	2 1/2"	25
E02100	1"	2 7/8"	25
E02125	1 1/4"	2 7/8"	25
E02150	1 1/2"	3"	25
E02152	1 1/2"	3 1/2"	25
E02200	2"	3 1/2"	25

Low Pattern- Tubular			
PART NO.	SIZE	FLANGE OD	CTN QTY
E03125	1 1/4"	2 7/8"	25
E03150	1 1/2"	2 7/8"	25
E03200	2"	3 1/2"	25

Box Pattern- Tubular			
PART NO.	SIZE	FLANGE OD	CTN QTY
E04125	1 1/4"	3"	5
E04150	1 1/2"	3"	5
E04200	2"	3"	5

Box Pattern- Iron Pipe Size			
PART NO.	SIZE	FLANGE OD	CTN QTY
E05125	1 1/4"	3"	5
E05150	1 1/2"	3"	5

Bell Pattern- Iron Pipe Size			
PART NO.	SIZE	FLANGE OD	CTN QTY
E06375	3/8"	2 3/8"	25
E06050	1/2"	2 3/8"	25
E06075	3/4"	2 3/8"	25
E06100	1"	3"	25
E06125	1 1/4"	3"	25
E06150	1 1/2"	3"	25

Bell Pattern- Copper Tube Size			
PART NO.	SIZE	FLANGE OD	CTN QTY
E07025	1/4" (3/8" OD)	2 3/8"	25
E07375	3/8" (1/2" OD)	2 3/8"	25
E07050	1/2" (5/8" OD)	2 3/8"	25

Bell Pattern- Tubular			
PART NO.	SIZE	FLANGE OD	CTN QTY
E08125	1 1/4" OD	3"	25
E08138	1 3/8" OD	3"	25
E08150	1 1/2" OD	3"	25

Plastic Shallow Flange Escutcheons



- Tight fit
- Low cost
- Corrosion-proof, indestructible, high-density polyethylene
- CARTON QUANTITIES ONLY

Copper Tube Size

PART NO.	SIZE	COLOR	CTN QTY
E15375	1/2" OD (3/8" CTS)	White	50
E15050	5/8" OD (1/2" CTS)	White	50
E15052	5/8" OD (1/2" CTS)	Almond	50
E15075	7/8" OD (3/4" CTS)	White	50

Iron Pipe Size

PART NO.	SIZE	COLOR	CTN QTY
E16375	3/8" IPS	White	50
E16050	1/2" IPS	White	50
E16075	3/4" IPS	White	50
E16150	1 1/2" IPS	White	50
E16151	1 1/2" IPS	Almond	50
E16200	2" IPS	White	50

Tubular

PART NO.	SIZE	COLOR	CTN QTY
E03225	1 1/4" Tubular	White	50
E03250	1 1/2" Tubular	White	50

Poly Bagged Escutcheons



- 50 per bag
- Chrome plated steel
- CARTON QUANTITIES ONLY

PART NO.	DESCRIPTION	CTN QTY
E01049	1/2" CTS (5/8" O.D.)	50
E01074	3/4" CTS (7/8" O.D.)	50

Floor & Ceiling Plates



- Chrome plated
- CARTON QUANTITIES ONLY

Light Gauge- Copper Tube Size

PART NO.	SIZE	FLANGE OD	CTN QTY
F01375	3/8" (1/2" OD)	2 1/2"	12
F01050	1/2" (5/8" OD)	2 5/8"	12
F01075	3/4" (7/8" OD)	2 27/32"	12
F01100	1" (1 1/8" OD)	3 9/32"	12
F01125	1 1/4" (1 3/8" OD)	3 5/8"	12
F01150	1 1/2" (1 5/8" OD)	3 15/16"	12

Light Gauge- Iron Pipe Size

PART NO.	SIZE	FLANGE OD	CTN QTY
F02375	3/8"	2 1/2"	12
F02050	1/2"	2 5/8"	12
F02075	3/4"	2 27/32"	12
F02100	1"	3 9/32"	12
F02125	1 1/4"	3 5/8"	12
F02150	1 1/2"	3 15/16"	12
F02200	2"	4 3/8"	12

Floor & Ceiling Plates (cont.)

Heavy Gauge With Springs- Copper Tube Size

PART NO.	SIZE	FLANGE OD	CTN QTY
F03375	3/8" (1/2" OD)	2 1/8"	12
F03050	1/2" (5/8" OD)	2 7/16"	12
F03075	3/4" (7/8" OD)	2 21/32"	12
F03100	1" (1 1/8" OD)	2 27/32"	12
F03125	1 1/4" (1 3/8" OD)	3 9/32"	12
F03150	1 1/2" (1 5/8" OD)	3 5/8"	12
F03200	2" (2 1/8" OD)	4 3/16"	12
F03250	2 1/2" (2 5/8" OD)	4 15/16"	6
F03300	3" (3 1/8" OD)	5 3/16"	6

Heavy Gauge With Springs- Iron Pipe Size

PART NO.	SIZE	FLANGE OD	CTN QTY
F04375	3/8"	2 1/2"	12
F04050	1/2"	2 5/8"	12
F04075	3/4"	2 27/32"	12
F04100	1"	3 9/32"	12
F04125	1 1/4"	3 5/8"	12
F04150	1 1/2"	3 15/16"	12
F04200	2"	4 3/8"	12
F04250	2 1/2"	5 7/32"	6
F04300	3"	5 29/32"	6
F04350	3 1/2"	6 9/16"	6
F04400	4"	7 3/16"	6
F04500	5"	8 7/8"	1
F04600	6"	10"	1
F04800	8"	13"	1
F04999	10"	15"	1

Flexible Floor & Ceiling Plates



- Chrome plated
- CARTON QUANTITIES ONLY

Chrome Plated Plastic

PART NO.	IPS	CTS	FLANGE OD	CTN QTY
F06375	3/8"	1/2"	2.572	12
F06050	1/2"	3/4"	2.787	12
F06075	3/4"	-	2.997	12
F06099	-	1"	3.077	12
F06100	1"	-	3.210	12
F06124	-	1 1/4"	3.308	12
F06125	1 1/4"	1 1/2"	3.580	12
F06150	1 1/2"	-	3.900	12
F06200	2"	-	4.450	12
F06201	-	2"	4.205	12
F06250	2 1/2"	-	5.313	12
F06251	-	2 1/2"	4.688	12
F06300	3"	-	5.875	12
F06301	-	3"	5.375	12
F06351	-	3 1/2"	5.875	12
F06400	4"	-	6.781	12
F06401	-	4"	6.344	12
F06500	5"	-	8.531	6
F06600	6"	-	9.688	6
F06800	8"	-	13.000	6

Flexible Floor & Ceiling Plates (cont.)

White Plastic				
PART NO.	IPS	CTS	FLANGE OD	CTN QTY
F07375	3/8"	1/2"	2.572	12
F07050	1/2"	3/4"	2.787	12
F07075	3/4"	-	2.997	12
F07099	-	1"	3.077	12
F07100	1"	-	3.210	12
F07124	-	1 1/4"	3.308	12
F07125	1 1/4"	1 1/2"	3.580	12
F07150	1 1/2"	-	3.900	12
F07200	2"	-	4.450	12
F07201	-	2"	4.205	12
F07300	3"	-	5.825	12

Sewer Popper™ Cleanout And Relief Valve

- Automatic pop-up releases sewage overflow outside the house
- Prevents thousands of dollars in property damages
- Eliminates health hazards associated with sewage overflow
- Vandal- and tamper-resistant center
- Threaded for 3" or 4" pipe or tapped together
- Constructed of white PVC
- Threaded unit can be used with PVC or ABS tapped together
- For cast iron pipe, use standard no hub clamp
- Meets Southern Building Code Section 301.10, Principle No.10
- Patent No. 5,209,257

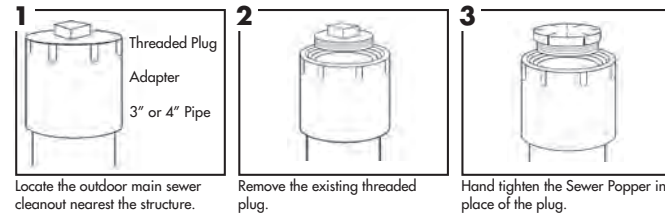

PART NO.	DESCRIPTION	CTN QTY
S62304	3"x 4" Sewer Popper™	6

Sewer Relief Valve And Cleanout

- Releases waste to outside of buildings in the event of sewer line blockage, preventing costly damage due to sewage backflow or overflow.
- Applicable in residential, commercial, or industrial settings- any structure connected to sewer lines or septic tanks
- Patent #4,475,571
- Meets ASTM specifications
- Automatic unlock and re-lock
- Vandal- resistant
- Safe in yard or high traffic areas
- Solvent welds over 4" Schedule 40 DWV pipe
- Removable lid provides full access to cleanout
- May be used to replace existing exterior cleanouts
- Easily adaptable to new or existing sewer lines
- Water and waste swirl in bowl until blockage is cleared

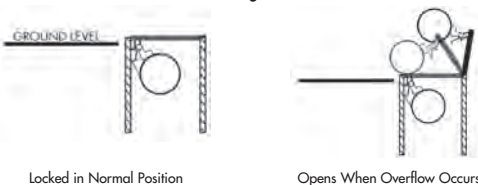

PART NO.	DESCRIPTION	CTN QTY
S62100	PVC sewer relief valve	1
S62101	ABS sewer relief valve	1

Sewer Stopper/ Backflow Preventer



- Use inside drain line to help guard against backups
- Creates seal in pipe to reduce sewer gases
- Secures into place with set screws
- Compression fit

PART NO.	DESCRIPTION	CTN QTY
S63200	2" sewer stopper (ZP steel)	100
S63300	3" sewer stopper (brass)	50
S63400	4" sewer stopper (brass)	40

Cover Plates

- Mirrored acrylic
- Conceals damaged/cracked tiles
- Fits all standard bath/shower fittings
- No tools required- use silicone caulk
- DO NOT use abrasive cleaners

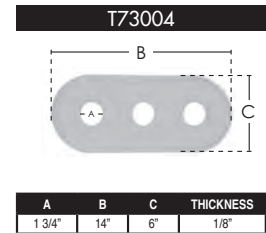
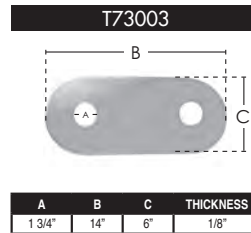
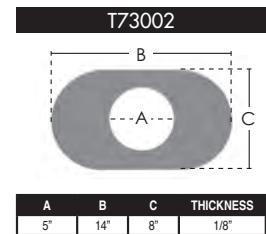
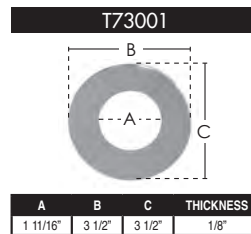
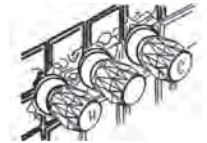

PART NO.	DESCRIPTION	SIZE	CTN QTY
T73001	Tube spout model	3 1/2" diameter	1
T73002	One handle model	8" x 14"	1
T73003	Two handle model	6" x 14"	1
T73004	Three handle model	6" x 14"	1

Stainless Steel Repair Cover Plates



- 1, 2 or 3 hole design to fit multitude of valves
- Polished stainless steel finish
- Easily attaches with silicone caulk; one hole has brackets and screw
- 7 1/4" x 13" long

PART NO.	# OF HOLES	DIAMETER	CTN QTY
T73815	1	5 1/8"	1
T73816	2	1 3/8"	1
T73817	3	1 3/8"	1
T73818	1	3 3/4"	1

Trap Covers

- Meets all specs of ADA Mandate
- Protects against scapes and burns
- Provides excellent impact protection
- Fits 1 1/4" and 1 1/2" tubular and cast brass pipe
- Also fits plastic pipe and NY/LA cast brass trap
- S04507 thru S04510 Meets ASTM E84-01



PART NO.	PLUMBEREX #	DESCRIPTION	CTN QTY
S04500	X4333	Trap and 2 stops	1
S04501	X4222	Trap and stop cover	1
S04502	X4444	Trap, 2 stops and 1 offset	1
S04503	X4111	Trap cover	1
S04504	X4112	Stop cover	1
S04505	X4114	Offset drain cover	1
S04506	X4116	Continuous waste cover	1
S04507	307	Velcro p-trap cover	1
S04508	327	Velcro angle stop valve and supply cover	1
S04509	396	Velcro p-trap and 2 valve and supply cover	1
S04510	427	Velcro p-trap and 2 valve and supply cover and offset cover	1

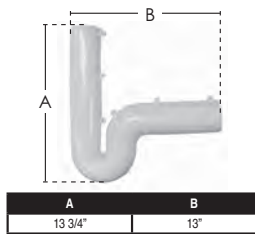

S04503

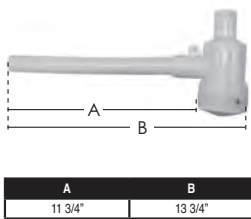

S04504

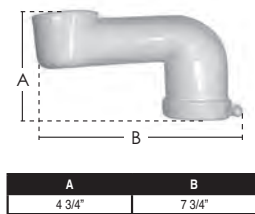

S04505

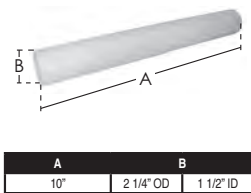

S04506



S04507



S04508

Covers have been tested and certified to comply with the following:

- Material - PVC
- Nominal Wall Thickness - 1/4"
- Color - UV Resistant White

Complies with:

- UBC 85 BOCA California Title 24 Article P1504B
- ANSI A117.1 IAPMO 80-93
- S04507 thru S04510 meets ASTM E84-01

Flexible Stainless-Steel Plumbing Connectors



- Reliable, trouble-free service- Inner core of non-toxic polymer withstands temperatures of 33°F (1°C) to 174°F (99°C)
- Leak proof seal- High quality outer braid of stainless steel and exclusive crimp-on fittings for maximum performance
- Quick and easy installation- No special tools; no soldering
- No pipe bending- Flexible connectors simplify installation- even in cramped spaces
- Chrome plated nut
- These products are NSF approved
- LEAD FREE

Faucet

PART NO.	OD x FIP	LENGTH	CTN QTY
S04200	3/8" x 1/2"	9	25
S04201	3/8" x 1/2"	12	25
S04202	3/8" x 1/2"	16	25
S04203	3/8" x 1/2"	20	25
S04204	3/8" x 1/2"	30	25
S04205	3/8" x 1/2"	36	25
S04206	1/2" x 1/2"	12	25
S04207	1/2" x 1/2"	16	25
S04208	1/2" x 1/2"	20	25
S04209	1/2" x 1/2"	30	25
S04210	1/2" x 1/2"	36	25

Faucet

PART NO.	FIP x FIP	LENGTH	CTN QTY
S04211	1/2" x 1/2"	12	25
S04212	1/2" x 1/2"	16	25
S04213	1/2" x 1/2"	20	25
S04214	1/2" x 1/2"	30	25
S04215	1/2" x 1/2"	36	25

Flexible Stainless-Steel Plumbing Connectors



- Reliable, trouble-free service- Inner core of non-toxic polymer withstands temperatures of 33°F (1°C) to 174°F (99°C)
- Leak proof seal- High quality outer braid of stainless steel and exclusive crimp-on fittings for maximum performance
- Quick and easy installation- No special tools; no soldering
- No pipe bending- Flexible connectors simplify installation- even in cramped spaces
- LEAD FREE

Ballcock

PART NO.	OD x BC	LENGTH	CTN QTY
S04216	3/8" x 7/8"	9	25
S04217	3/8" x 7/8"	12	25
S04218	3/8" x 7/8"	16	25
S04219	3/8" x 7/8"	20	25
S04220	1/2" x 7/8"	9	25
S04221	1/2" x 7/8"	12	25
S04222	1/2" x 7/8"	16	25
S04223	1/2" x 7/8"	20	25
S04255	3/8" x 7/8" w/ brass nut	12	25

Ballcock

PART NO.	FIP x BC	LENGTH	CTN QTY
S04224	1/2" x 7/8"	9	25
S04225	1/2" x 7/8"	12	25
S04226	1/2" x 7/8"	20	25

Ballcock

PART NO.	FLARE x BC	LENGTH	CTN QTY
S04280	1/2" x 7/8"	20	25
S04285	3/8" x 7/8"	20	25

Washing Machine

PART NO.	FEM HOSE x FEM HOSE	LENGTH	CTN QTY
S04227	3/4" x 3/4"	48	5
S04228	3/4" x 3/4"	60	5
S04229	3/4" x 3/4"	72	5

Icemaker

PART NO.	OD x OD	LENGTH	CTN QTY
S04230	1/4" x 1/4"	12	5
S04231	1/4" x 1/4"	60	5
S04232	1/4" x 1/4"	84	5

Flexible Stainless-Steel Plumbing Connectors



- Reliable, trouble-free service- Inner core of non-toxic polymer withstands temperatures of 33°F (1°C) to 174°F (81°C); burst pressure 1,000 PSI
- Leak proof seal- High quality outer braid of stainless steel and exclusive crimp-on fittings for maximum performance
- Quick and easy installation- No special tools; no soldering
- No pipe bending- Flexible connectors simplify installation- even in cramped spaces
- Chrome plated nut
- These products are NSF approved
- LEAD FREE

Dishwasher Connectors

90° Elbow

PART NO.	OD x MIP	LENGTH	CTN QTY
S04233	3/8" x 3/8"	48	25
S04234	3/8" x 3/8"	60	25
S04235	3/8" x 3/8"	72	25
S04236	1/2" x 3/8"	48	25
S04237	1/2" x 3/8"	60	25
S04238*	1/2" x 3/8"	72	25

*elbow not included

Dishwasher Connectors

PART NO.	OD x OD	LENGTH	CTN QTY
S04260	3/8" x 3/8"	48	25
S04268	3/8" x 3/8"	12	25
S04269	3/8" x 3/8"	16	25
S04270	3/8" x 3/8"	20	25

SS "Delta" Style Faucet Connectors

*Complies with NSF 61

PART NO.	OD x COMP FITTING	LENGTH	CTN QTY
S04239	3/8" x 3/8"	9	25
S04240	3/8" x 3/8"	12	25
S04241	3/8" x 3/8"	16	25
S04242	3/8" x 3/8"	20	25
S04243	3/8" x 3/8"	30	25
S04244	3/8" x 3/8"	36	25

Texas Style Faucet Connectors

*Complies with NSF 61

PART NO.	FL x OD	LENGTH	CTN QTY
S04245	3/8" x 3/8"	9	25
S04246	3/8" x 3/8"	12	25
S04247	3/8" x 3/8"	16	25
S04248	3/8" x 3/8"	20	25
S04249	3/8" x 3/8"	30	25
S04250	3/8" x 3/8"	36	25

Braided Nylon Plumbing Connectors



- Reliable, economy style connectors
- Temperature rated 173° (82°C)
- Burst pressure is 450 PSI
- Chrome plated nut
- These products are UPC approved
- LEAD FREE

Nylon Faucet Connectors

PART NO.	OD x FIP	LENGTH	CTN QTY
S04400	3/8" x 1/2"	9	25
S04401	3/8" x 1/2"	12	25
S04402	3/8" x 1/2"	16	25
S04403	3/8" x 1/2"	20	25
S04404	3/8" x 1/2"	30	25
S04405	1/2" x 1/2"	12	25
S04406	1/2" x 1/2"	16	25
S04407	1/2" x 1/2"	20	25
S04408	1/2" x 1/2"	30	25

Nylon Faucet Connectors

PART NO.	FIP x FIP	LENGTH	CTN QTY
S04409	1/2" x 1/2"	12	25
S04410	1/2" x 1/2"	16	25
S04411	1/2" x 1/2"	20	25
S04440	1/2" x 1/2"	36	25

Nylon Faucet Connectors

PART NO.	COMP x FIP	LENGTH	CTN QTY
S04450	3/8" x 1/2"	24	25
S04455	3/8" x 1/2"	36	25

Nylon Delta Connectors

PART NO.	OD x COMP FITTING	LENGTH	CTN QTY
S04412	3/8" x 3/8"	12	25
S04413	3/8" x 3/8"	20	25

Nylon Toilet Connectors

PART NO.	OD x BC	LENGTH	CTN QTY
S04414	3/8" x 7/8"	9	25
S04415	3/8" x 7/8"	12	25
S04416	3/8" x 7/8"	16	25
S04417	3/8" x 7/8"	20	25
S04418	1/2" x 7/8"	9	25
S04419	1/2" x 7/8"	12	25
S04420	1/2" x 7/8"	16	25
S04421	1/2" x 7/8"	20	25

Nylon Toilet Connectors

PART NO.	FIP x BC	LENGTH	CTN QTY
S04422	1/2" x 7/8"	9	25
S04423	1/2" x 7/8"	12	25
S04424	1/2" x 7/8"	20	25

Nylon Dishwasher Connectors

90° Elbow

PART NO.	OD x MIP	LENGTH	CTN QTY
S04430	3/8" x 3/8"	72	25

"PEX" Supply Tubes (3/8" OD)



- NSF listed material
- Rated 100 psi at 180°F
- Resistant to corrosion and damage due to freezing
- Use with standard compression stops or valves

Basin Supply Tubes

PART NO.	DESCRIPTION	CTN QTY
S04101	3/8" x 12"	10500
S04102	3/8" x 15"	10500
S04103	3/8" x 20"	10500
S04104	3/8" x 30"	10500
S04108	3/8" x 36"	10500

Tank Supply Tubes

PART NO.	DESCRIPTION	CTN QTY
S04105	3/8" x 12"	10500
S04106	3/8" x 15"	10500
S04107	3/8" x 20"	10500

Chrome Plated Flexible Basin Supply Tube



PART NO.	DESCRIPTION	CTN QTY
S04020	3/8" x 12"	100
S04021	3/8" x 16"	100
S04022	3/8" x 20"	100
S04023	3/8" x 30"	100
S04024	3/8" x 36"	100
S04025	1/2" x 12"	100
S04026	1/2" x 20"	100

Chrome Plated Flexible Tank Supply Tube



PART NO.	DESCRIPTION	CTN QTY
S04027	3/8" x 12"	100
S04028	3/8" x 16"	100
S04029	3/8" x 20"	100
S04030	1/2" x 12"	100

Flexible Tank Supply Tube



- Chrome plated
- With rubber nose cone

PART NO.	DESCRIPTION	CTN QTY
S04031	3/8" x 12"	100
S04032	3/8" x 20"	100

PEX Supply Tube With Ferrule



- NSF listed material
- Supplied with ferrule
- Rated 100 PSI at 180°

PART NO.	DESCRIPTION	CTN QTY
S04121	3/8" x 12 Basin	10
S04123	3/8" x 20 Basin	10
S04124	3/8" x 30 Basin	10
S04128	3/8" x 36 Basin	10
S04125	3/8" x 12 Tank	10
S04127	3/8" x 20 Tank	10

Supply Stop-180° Turn



• UPC listed

PART NO.	DESCRIPTION	CTN QTY
S10200	3/8 FIP x OD Angle	1
S10201	3/8 FIP x 3/8 OD Straight	1
S10202	1/2 FIP x 1/4 OD Angle	1
S10203	1/2 FIP x 3/8 OD Angle	1
S10204	1/2 FIP x 7/16 OD Angle	1
S10205	1/2 FIP x 1/2 OD Angle	1
S10206	1/2 FIP x 3/8 OD Straight	1
S10207	1/2 FIP x 1/2 OD Straight	1
S10208	3/8 OD x 3/8 OD Straight	1
S10209	5/8 OD x 1/4 OD Angle	1
S10210	5/8 OD x 3/8 OD Angle	1
S10211	5/8 OD x 3/8 OD Crse Thread Angle	1
S10212	5/8 OD x 7/16 OD Angle	1
S10213	5/8 OD x 1/2 OD Angle	1
S10214	5/8 OD x 3/8 OD Straight	1
S10215	5/8 OD x 1/2 OD Straight	1
S10216	1/2 Sweat x 3/8 OD Angle	1
S10217	1/2 Sweat x 1/2 OD Angle	1
S10218	1/2 Sweat x 3/8 OD Straight	1
S10219	1/2 Sweat x 1/2 OD Straight	1
S10220	1/2 FIP x 3/8 OD Dual	1
S10221	1/2 FIP x 7/16 OD x 7/16 OD Dual	1
S10222	1/2 FIP x 7/16 OD x 1/2 OD Dual	1
S10223	1/2 FIP x 1/2 OD x 3/8 OD Dual	1
S10224	1/2 FIP x 1/2 OD x 1/2 OD Dual	1
S10260	1/2 PEX x 1/4 OD Angle	1
S10261	1/2 PEX x 3/8 OD Angle	1
S10262	3/8 PEX x 3/8 OD Angle	1
S10267	1/2 PEX x 3/8 OD Straight	1
S10275	1/2 CPVC x 3/8 OD Straight	1
S10280	1/2 CPVC x 3/8 OD Angle	1
LEAD FREE		
PART NO.	DESCRIPTION	CTN QTY
S10300	1/2 FIP x 3/8 OD Angle	1
S10301	5/8 OD x 3/8 OD Angle	1
S10302	1/2 FIP x 3/8 OD Straight	1
S10303	5/8 OD x 5/8 OD Straight	1

Supply Stop-1/4 Turn



• UPC listed

PART NO.	DESCRIPTION	CTN QTY
S10225	3/8 FIP x 3/8 OD Angle	1
S10226	3/8 FIP x 3/8 OD Straight	1
S10227	1/2 FIP x 1/4 OD Angle	1
S10228	1/2 FIP x 3/8 OD Angle	1
S10229	1/2 FIP x 7/16 OD Angle	1
S10230	1/2 FIP x 1/2 OD Angle	1
S10231	1/2 FIP x 3/8 OD Straight	1
S10232	1/2 FIP x 1/2 OD Straight	1
S10233	3/8 OD x 3/8 OD Straight	1
S10234	5/8 OD x 1/4 OD Angle	1
S10235	5/8 OD x 3/8 OD Angle	1
S10236	5/8 OD x Crse Thrd x 3/8 OD Angle	1
S10237	5/8 OD x 7/16 OD Angle	1
S10238	5/8 OD x 1/2 OD Angle	1
S10239	5/8 OD x 3/8 OD Straight	1
S10240	5/8 OD x 1/2 OD Straight	1
S10241	1/2 Sweat x 3/8 OD Angle	1
S10242	1/2 Sweat x 1/2 OD Angle	1
S10243	1/2 Sweat x 3/8 OD Straight	1
S10244	1/2 Sweat x 1/2 OD Straight	1
S10247	1/2 FIP x 3/8 OD x 3/8 OD Dual	1
S10248	1/2 FIP x 7/16 OD x 7/16 OD Dual	1
S10249	1/2 FIP x 7/16 OD x 1/2 Dual	1
S10250	1/2 FIP x 1/2 OD x 3/8 OD Dual	1
S10251	1/2 FIP x 1/2 OD x 1/2 OD Dual	1
S10252	5/8 OD x 3/8 OD x 3/8 OD Dual	1
S10253	5/8 OD x 3/8 OD x 1/4 OD Dual	1
S10263	1/2 PEX x 1/4 OD Angle	1
S10264	1/2 PEX x 3/8 OD Angle	1
S10265	3/8 PEX x 3/8 OD Angle	1
S10266	1/2 PEX x 3/8 OD Straight	1
LEAD FREE		
PART NO.	DESCRIPTION	CTN QTY
S10310	1/2 FIP x 3/8 OD Angle	1
S10311	5/8 OD x 3/8 OD Angle	1
S10312	1/2 FIP x 3/8 OD Straight	1
S10313	5/8 OD x 3/8 OD Straight	1
S10314	1/2 PEX x 3/8 OD Angle	1
S10315	1/2 PEX x 3/8 OD Straight	1

Drinking Fountain Bubbler and Cartridge



- 3/8" FIP connection
- Stainless steel cartridge
- Chrome plated brass body
- LEAD FREE- meets NSF standard 61.9

PART NO.	DESCRIPTION	CTN QTY
B45215	CP Brass bubbler with stainless steel cartridge	1
B45216	Replacement cartridge	1

Drinking Fountain Bubbler With Face Guard



Flexible Water Shield

- LEAD FREE- Meets NSF 61.9
- Chrome plated brass body
- Equipped with unique neo-poly water shield to prevent injuries to teeth, gums and face
- Tamper proof design requires 5/16" hex key to remove/ replace water shield for cleaning
- B45218 Kit includes new water shield, washer, and retainer nut

PART NO.	DESCRIPTION	CTN QTY
B45216	Replacement cartridge	1
B45217	Bubbler	1
B45218	Polymer Water Shield Kit	1

Self-Closing Drinking Fountain



- Mildew resistant
- Perfect for schools
- Chrome plated brass
- Stainless steel cartridge
- 1/2" Female pipe threads

PART NO.	DESCRIPTION	CTN QTY
B45200	Drinking Fountain	1

Retrofit Bubbler Kit



- Replaces fountain on china fixtures
- Contains bubbler 1/2" x 3/8" x 3 1/2" nipple, rosette flange, locknut, coupling nut and 1 3/4" faucet cover

PART NO.	DESCRIPTION	CTN QTY
B45220	Drinking Fountain	1

Cross Handle Self Closing Valve



- Heavy brass construction
- Chrome plated

PART NO.	DESCRIPTION	CTN QTY
S05105	1/2" FIP	12

Single Kitchen Sink Faucet



- Chrome plated bodies and tee handles
- Replaceable washers

PART NO.	INLET	FLANGE	CTN QTY
S08003	1/2" FIP	Fixed (3/4" hose outlet)	5

Wall Mount Sink Faucet



- 8" center to center
- Adjustable 1/2" female threaded eccentric couplings
- Replaceable seats and stems
- Chrome plated with soap dish mounted on body
- Meets NSF standard 61.9

PART NO.	DESCRIPTION	CTN QTY
S08008	8" tubular spout	5
S08012	12" tubular spout	5
S08030	Hot repair kit (handle, stem and seat)	1
S08031	Cold repair kit (handle, stem and seat)	1
S08032	Union repair kit (union assembly)	1

LEAD FREE

PART NO.	DESCRIPTION	CTN QTY
S08018	8" tubular spout	5

Laundry Tray Faucets



A01006

- Supplied with garden hose adapter and A01006 aerator
- Can be used either way with either adapter or aerator
- Meets Detroit Code

PART NO.	DESCRIPTION	CTN QTY
L47001	Chrome	24
L47002	Hot repair kit (stem and seat)	1
L47003	Cold repair kit (stem and seat)	1
L47004	With Gooseneck spout	24

Basin Faucet



Heavy Pattern



Standard Pattern

- Chrome plated
- Replaceable seats and stems
- Furnished with hot and cold buttons
- Meets NSF standard 61.9

PART NO.	DESCRIPTION	CTN QTY
F39001	Heavy pattern with aerator	1
F39002	Standard pattern	12
F39004	Repair kit for 002 series (Handle, seat, stem and buttons)	5
F39005	Repair kit for 001 series (Handles, seat, stem and buttons)	5

Self-Closing Basin Faucet and Shower Valve



Self-Closing Basin Faucet



Shower Valve with Pull Chain

- Chrome plated heavy duty pattern
- Deluxe aerator
- 1/2" FIP connection
- Replaceable stem, cam and spring mechanism
- Shower valves ideal for urinals when used with standpipe assembly

PART NO.	DESCRIPTION	CTN QTY
F39010	Basin Faucet	12
S05100	Shower valve with pull chain (7" chain)	12
S05102	Standpipe assembly for urinal	5
S05101	Repair kit (stem and cam mechanism)	1

Service Sink Faucets



Lever Handles



Cross Handles



S55352

- Integral stops; 1/4 turn for S55349
- Complete with all mounting hardware
- Integrated vacuum breaker (ASSE 1001)
- Front hook to hang bucket

PART NO.	DESCRIPTION	CTN QTY
S55349	Service sink faucet with lever handles	1
S55350	Service sink faucet with cross handles	1
S55351	Cross handle stem repair kit for S55350	1
S55352	Lever handle and stem repair kit S55349	1
S55353	Integral stop repair kit for S55350	1
S55354	Vacuum breaker repair kit for S55350	1

Hose & Hose Bracket for Service Sink



- Heavy duty 300 PSI cloth-reinforced hose
- 3/4" brass hose coupling at one end
- 5" x 3" stainless steel bracket with rubber grips

PART NO.	DESCRIPTION	CTN QTY
M05001	30" hose with bracket	1
M05005	Bracket only	1

Mop Hanger for Service Sink

- 24" x 3" stainless steel hanger with three rubber tool grips
- Anchors included



PART NO.	DESCRIPTION	CTN QTY
M05003	Mop hanger	1

3/8" OD Uncoated w/Fittings



- Corrugation extends all the way to the fitting for increased tubing flexibility
- CSA Design certified domestically and internationally for indoor and outdoor use
- 100% leak tested to ensure Safety and Quality and a product you can trust
- Quality flared end fittings to create a metal to metal seal in critical applications
- Durable stainless steel 304. Corrosion resistant.

PART NO.	DESCRIPTION	CTN QTY
G70000	1/2" MIP x 1/2" MIP x 12"	25
G70001	1/2" FIP x 1/2" FIP x 12"	25
G70002	3/8" FIP x 3/8" FIP x 12"	25
G70003	1/2" FIP x 1/2" MIP x 12"	25
G70004	1/2" FIP x 3/8" MIP x 12"	25
G70005	3/8" FIP x 1/2" MIP x 12"	25
G70006	3/8" FIP x 3/8" MIP x 12"	25
G70007	1/2" MIP x 1/2" MIP x 18"	25
G70008	1/2" FIP x 1/2" FIP x 18"	25
G70009	3/8" FIP x 3/8" FIP x 18"	25
G70010	1/2" FIP x 1/2" MIP x 18"	25
G70011	1/2" FIP x 3/8" MIP x 18"	25
G70012	3/8" FIP x 1/2" MIP x 18"	25
G70013	3/8" FIP x 3/8" MIP x 18"	25
G70014	1/2" MIP x 1/2" MIP x 24"	25
G70015	1/2" FIP x 1/2" FIP x 24"	25
G70016	3/8" FIP x 3/8" FIP x 24"	25
G70017	1/2" FIP x 1/2" MIP x 24"	25
G70018	1/2" FIP x 3/8" MIP x 24"	25
G70019	3/8" FIP x 1/2" MIP x 24"	25
G70020	3/8" FIP x 3/8" MIP x 24"	25
G70021	1/2" MIP x 1/2" MIP x 30"	25
G70022	1/2" FIP x 1/2" FIP x 30"	25
G70023	3/8" FIP x 3/8" FIP x 30"	25
G70024	1/2" FIP x 1/2" MIP x 30"	25
G70025	1/2" FIP x 3/8" MIP x 30"	25
G70026	3/8" FIP x 1/2" MIP x 30"	25
G70027	3/8" FIP x 3/8" MIP x 30"	25
G70028	1/2" MIP x 1/2" MIP x 36"	25
G70029	1/2" FIP x 1/2" FIP x 36"	25
G70030	3/8" FIP x 3/8" FIP x 36"	25
G70031	1/2" FIP x 1/2" MIP x 36"	25
G70032	1/2" FIP x 3/8" MIP x 36"	25
G70033	3/8" FIP x 1/2" MIP x 36"	25
G70034	3/8" FIP x 3/8" MIP x 36"	25
G70035	1/2" MIP x 1/2" MIP x 48"	25
G70036	1/2" FIP x 1/2" FIP x 48"	25
G70037	3/8" FIP x 3/8" FIP x 48"	25
G70038	1/2" FIP x 1/2" MIP x 48"	25
G70039	1/2" FIP x 3/8" MIP x 48"	25
G70040	3/8" FIP x 1/2" MIP x 48"	25
G70041	3/8" FIP x 3/8" MIP x 48"	25
G70042	1/2" MIP x 1/2" MIP x 60"	25
G70043	1/2" FIP x 1/2" FIP x 60"	25
G70044	3/8" FIP x 3/8" FIP x 60"	25
G70045	1/2" FIP x 1/2" MIP x 60"	25

3/8" OD Uncoated w/Fittings (cont.)



- Corrugation extends all the way to the fitting for increased tubing flexibility
- CSA Design certified domestically and internationally for indoor and outdoor use
- 100% leak tested to ensure Safety and Quality and a product you can trust
- Quality flared end fittings to create a metal to metal seal in critical applications
- Durable stainless steel 304. Corrosion resistant.

PART NO.	DESCRIPTION	CTN QTY
G70046	1/2" FIP x 3/8" MIP x 60"	25
G70047	3/8" FIP x 1/2" MIP x 60"	25
G70048	3/8" FIP x 3/8" MIP x 60"	25
G70049	1/2" MIP x 1/2" MIP x 72"	25
G70050	1/2" FIP x 1/2" FIP x 72"	25
G70051	3/8" FIP x 3/8" FIP x 72"	25
G70052	1/2" FIP x 1/2" MIP x 72"	25
G70053	1/2" FIP x 3/8" MIP x 72"	25
G70054	3/8" FIP x 1/2" MIP x 72"	25
G70055	3/8" FIP x 3/8" MIP x 72"	25

3/8" OD Coated w/Fittings



- Corrugation extends all the way to the fitting for increased tubing flexibility
- CSA Design certified domestically and internationally for indoor and outdoor use
- 100% leak tested to ensure Safety and Quality and a product you can trust
- Quality flared end fittings to create a metal to metal seal in critical applications
- Durable stainless steel 304. Corrosion resistant.
- Coated connectors add additional safety in highly corrosive environments or in areas where caustic chemicals are located

PART NO.	DESCRIPTION	CTN QTY
G70100	1/2" MIP x 1/2" MIP x 12"	25
G70101	1/2" FIP x 1/2" FIP x 12"	25
G70102	3/8" FIP x 3/8" FIP x 12"	25
G70103	1/2" FIP x 1/2" MIP x 12"	25
G70104	1/2" FIP x 3/8" MIP x 12"	25
G70105	3/8" FIP x 1/2" MIP x 12"	25
G70106	3/8" FIP x 3/8" MIP x 12"	25
G70107	1/2" MIP x 1/2" MIP x 18"	25
G70108	1/2" FIP x 1/2" FIP x 18"	25
G70109	3/8" FIP x 3/8" FIP x 18"	25
G70110	1/2" FIP x 1/2" MIP x 18"	25
G70111	1/2" FIP x 3/8" MIP x 18"	25
G70112	3/8" FIP x 1/2" MIP x 18"	25
G70113	3/8" FIP x 3/8" MIP x 18"	25
G70114	1/2" MIP x 1/2" MIP x 24"	25
G70115	1/2" FIP x 1/2" FIP x 24"	25
G70116	3/8" FIP x 3/8" FIP x 24"	25
G70117	1/2" FIP x 1/2" MIP x 24"	25
G70118	1/2" FIP x 3/8" MIP x 24"	25
G70119	3/8" FIP x 1/2" MIP x 24"	25
G70120	3/8" FIP x 3/8" MIP x 24"	25
G70121	1/2" MIP x 1/2" MIP x 30"	25
G70122	1/2" FIP x 1/2" FIP x 30"	25

3/8" OD Coated w/Fittings (cont.)



- Corrugation extends all the way to the fitting for increased tubing flexibility
- CSA Design certified domestically and internationally for indoor and outdoor use
- 100% leak tested to ensure Safety and Quality and a product you can trust
- Quality flared end fittings to create a metal to metal seal in critical applications
- Durable stainless steel 304. Corrosion resistant.
- Coated connectors add additional safety in highly corrosive environments or in areas where caustic chemicals are located

PART NO.	DESCRIPTION	CTN QTY
G70123	3/8" FIP x 3/8" FIP x 30"	25
G70124	1/2" FIP x 1/2" MIP x 30"	25
G70125	1/2" FIP x 3/8" MIP x 30"	25
G70126	3/8" FIP x 1/2" MIP x 30"	25
G70127	3/8" FIP x 3/8" MIP x 30"	25
G70128	1/2" MIP x 1/2" MIP x 36"	25
G70129	1/2" FIP x 1/2" FIP x 36"	25
G70130	3/8" FIP x 3/8" FIP x 36"	25
G70131	1/2" FIP x 1/2" MIP x 36"	25
G70132	1/2" FIP x 3/8" MIP x 36"	25
G70133	3/8" FIP x 1/2" MIP x 36"	25
G70134	3/8" FIP x 3/8" MIP x 36"	25
G70135	1/2" MIP x 1/2" MIP x 48"	25
G70136	1/2" FIP x 1/2" FIP x 48"	25
G70137	3/8" FIP x 3/8" FIP x 48"	25
G70138	1/2" FIP x 1/2" MIP x 48"	25
G70139	1/2" FIP x 3/8" MIP x 48"	25
G70140	3/8" FIP x 1/2" MIP x 48"	25
G70141	3/8" FIP x 3/8" MIP x 48"	25
G70142	1/2" MIP x 1/2" MIP x 60"	25
G70143	1/2" FIP x 1/2" FIP x 60"	25
G70144	3/8" FIP x 3/8" FIP x 60"	25
G70145	1/2" FIP x 1/2" MIP x 60"	25
G70146	1/2" FIP x 3/8" MIP x 60"	25
G70147	3/8" FIP x 1/2" MIP x 60"	25
G70148	3/8" FIP x 3/8" MIP x 60"	25
G70149	1/2" MIP x 1/2" MIP x 72"	25
G70150	1/2" FIP x 1/2" FIP x 72"	25
G70151	3/8" FIP x 3/8" FIP x 72"	25
G70152	1/2" FIP x 1/2" MIP x 72"	25
G70153	1/2" FIP x 3/8" MIP x 72"	25
G70154	3/8" FIP x 1/2" MIP x 72"	25
G70155	3/8" FIP x 3/8" MIP x 72"	25

3/8" OD Uncoated with Ball Valves



- Corrugation extends all the way to the fitting for increased tubing flexibility
- CSA Design certified domestically and internationally for indoor and outdoor use
- 100% leak tested to ensure Safety and Quality and a product you can trust
- Quality flared end fittings to create a metal to metal seal in critical applications
- Durable stainless steel 304. Corrosion resistant.

PART NO.	DESCRIPTION	CTN QTY
G70200	3/8" MIP x 1/2" FIP Ball x 12"	25
G70201	1/2" MIP x 1/2" FIP Ball x 12"	25
G70202	1/2" FIP x 1/2" FIP Ball x 12"	25
G70203	3/8" FIP x 1/2" FIP Ball x 12"	25
G70204	3/8" MIP x 1/2" FIP Ball x 18"	25
G70205	1/2" MIP x 1/2" FIP Ball x 18"	25
G70206	1/2" FIP x 1/2" FIP Ball x 18"	25
G70207	3/8" FIP x 1/2" FIP Ball x 18"	25
G70208	3/8" MIP x 1/2" FIP Ball x 24"	25
G70209	1/2" MIP x 1/2" FIP Ball x 24"	25
G70210	1/2" FIP x 1/2" FIP Ball x 24"	25
G70211	3/8" FIP x 1/2" FIP Ball x 24"	25
G70212	3/8" MIP x 1/2" FIP Ball x 30"	25
G70213	1/2" MIP x 1/2" FIP Ball x 30"	25
G70214	1/2" FIP x 1/2" FIP Ball x 30"	25
G70215	3/8" FIP x 1/2" FIP Ball x 30"	25
G70216	3/8" MIP x 1/2" FIP Ball x 36"	25
G70217	1/2" MIP x 1/2" FIP Ball x 36"	25
G70218	1/2" FIP x 1/2" FIP Ball x 36"	25
G70219	3/8" FIP x 1/2" FIP Ball x 36"	25
G70220	3/8" MIP x 1/2" FIP Ball x 48"	25
G70221	1/2" MIP x 1/2" FIP Ball x 48"	25
G70222	1/2" FIP x 1/2" FIP Ball x 48"	25
G70223	3/8" FIP x 1/2" FIP Ball x 48"	25
G70224	3/8" MIP x 1/2" FIP Ball x 60"	25
G70225	1/2" MIP x 1/2" FIP Ball x 60"	25
G70226	1/2" FIP x 1/2" FIP Ball x 60"	25
G70227	3/8" FIP x 1/2" FIP Ball x 60"	25
G70228	3/8" MIP x 1/2" FIP Ball x 72"	25
G70229	1/2" MIP x 1/2" FIP Ball x 72"	25
G70230	1/2" FIP x 1/2" FIP Ball x 72"	25
G70231	3/8" FIP x 1/2" FIP Ball x 72"	25
G70232	1/2" MIP x 1/2" FIP Angle Ball x 48"	25
G70233	3/8" FIP x 1/2" FIP Angle Ball x 48"	25
G70234	1/2" MIP x 1/2" FIP Angle Ball x 60"	25
G70235	3/8" FIP x 1/2" FIP Angle Ball x 60"	25
G70236	1/2" MIP x 1/2" FIP Angle Ball x 72"	25
G70237	3/8" FIP x 1/2" FIP Angle Ball x 72"	25

3/8" OD Coated with Ball Valves



- Corrugation extends all the way to the fitting for increased tubing flexibility
- CSA Design certified domestically and internationally for indoor and outdoor use
- 100% leak tested to ensure Safety and Quality and a product you can trust
- Quality flared end fittings to create a metal to metal seal in critical applications
- Durable stainless steel 304. Corrosion resistant.
- Coated connectors add additional safety in highly corrosive environments or in areas where caustic chemicals are located

PART NO.	DESCRIPTION	CTN QTY
G70300	3/8" MIP x 1/2" FIP Ball x 12"	25
G70301	1/2" MIP x 1/2" FIP Ball x 12"	25
G70302	1/2" FIP x 1/2" FIP Ball x 12"	25
G70303	3/8" FIP x 1/2" FIP Ball x 12"	25
G70304	3/8" MIP x 1/2" FIP Ball x 18"	25
G70305	1/2" MIP x 1/2" FIP Ball x 18"	25
G70306	1/2" FIP x 1/2" FIP Ball x 18"	25
G70307	3/8" FIP x 1/2" FIP Ball x 18"	25
G70308	3/8" MIP x 1/2" FIP Ball x 24"	25
G70309	1/2" MIP x 1/2" FIP Ball x 24"	25
G70310	1/2" FIP x 1/2" FIP Ball x 24"	25
G70311	3/8" FIP x 1/2" FIP Ball x 24"	25
G70312	3/8" MIP x 1/2" FIP Ball x 30"	25
G70313	1/2" MIP x 1/2" FIP Ball x 30"	25
G70314	1/2" FIP x 1/2" FIP Ball x 30"	25
G70315	3/8" FIP x 1/2" FIP Ball x 30"	25
G70316	3/8" MIP x 1/2" FIP Ball x 36"	25
G70317	1/2" MIP x 1/2" FIP Ball x 36"	25
G70318	1/2" FIP x 1/2" FIP Ball x 36"	25
G70319	3/8" FIP x 1/2" FIP Ball x 36"	25
G70320	3/8" MIP x 1/2" FIP Ball x 48"	25
G70321	1/2" MIP x 1/2" FIP Ball x 48"	25
G70322	1/2" FIP x 1/2" FIP Ball x 48"	25
G70323	3/8" FIP x 1/2" FIP Ball x 48"	25
G70324	3/8" MIP x 1/2" FIP Ball x 60"	25
G70325	1/2" MIP x 1/2" FIP Ball x 60"	25
G70326	1/2" FIP x 1/2" FIP Ball x 60"	25
G70327	3/8" FIP x 1/2" FIP Ball x 60"	25
G70328	3/8" MIP x 1/2" FIP Ball x 72"	25
G70329	1/2" MIP x 1/2" FIP Ball x 72"	25
G70330	1/2" FIP x 1/2" FIP Ball x 72"	25
G70331	3/8" FIP x 1/2" FIP Ball x 72"	25
G70332	1/2" MIP x 1/2" FIP Angle Ball x 48"	25
G70333	3/8" FIP x 1/2" FIP Angle Ball x 48"	25
G70334	1/2" MIP x 1/2" FIP Angle Ball x 60"	25
G70335	3/8" FIP x 1/2" FIP Angle Ball x 60"	25
G70336	1/2" MIP x 1/2" FIP Angle Ball x 72"	25
G70337	3/8" FIP x 1/2" FIP Angle Ball x 72"	25

5/8" OD Uncoated w/Fittings



- Corrugation extends all the way to the fitting for increased tubing flexibility
- CSA Design certified domestically and internationally for indoor and outdoor use
- 100% leak tested to ensure Safety and Quality and a product you can trust
- Quality flared end fittings to create a metal to metal seal in critical applications
- Durable stainless steel 304. Corrosion resistant.

PART NO.	DESCRIPTION	CTN QTY
G71000	3/4" MIP x 3/4" MIP x 12"	25
G71001	3/4" MIP x 1/2" MIP x 12"	25
G71002	1/2" MIP x 1/2" MIP x 12"	25
G71003	3/4" FIP x 3/4" FIP x 12"	25
G71004	3/4" FIP x 1/2" FIP x 12"	25
G71005	1/2" FIP x 1/2" FIP x 12"	25
G71006	1/2" FIP x 3/4" MIP x 12"	25
G71007	3/4" FIP x 3/4" MIP x 12"	25
G71008	3/4" FIP x 1/2" MIP x 12"	25
G71009	1/2" FIP x 1/2" MIP x 12"	25
G71010	3/4" MIP x 3/4" MIP x 18"	25
G71011	3/4" MIP x 1/2" MIP x 18"	25
G71012	1/2" MIP x 1/2" MIP x 18"	25
G71013	3/4" FIP x 3/4" FIP x 18"	25
G71014	3/4" FIP x 1/2" FIP x 18"	25
G71015	1/2" FIP x 1/2" FIP x 18"	25
G71016	1/2" FIP x 3/4" MIP x 18"	25
G71017	3/4" FIP x 3/4" MIP x 18"	25
G71018	3/4" FIP x 1/2" MIP x 18"	25
G71019	1/2" FIP x 1/2" MIP x 18"	25
G71020	3/4" MIP x 3/4" MIP x 24"	25
G71021	3/4" MIP x 1/2" MIP x 24"	25
G71022	1/2" MIP x 1/2" MIP x 24"	25
G71023	3/4" FIP x 3/4" FIP x 24"	25
G71024	3/4" FIP x 1/2" FIP x 24"	25
G71025	1/2" FIP x 1/2" FIP x 24"	25
G71026	1/2" FIP x 3/4" MIP x 24"	25
G71027	3/4" FIP x 3/4" MIP x 24"	25
G71028	3/4" FIP x 1/2" MIP x 24"	25
G71029	1/2" FIP x 1/2" MIP x 24"	25
G71030	3/4" MIP x 3/4" MIP x 30"	25
G71031	3/4" MIP x 1/2" MIP x 30"	25
G71032	1/2" MIP x 1/2" MIP x 30"	25
G71033	3/4" FIP x 3/4" FIP x 30"	25
G71034	3/4" FIP x 1/2" FIP x 30"	25
G71035	1/2" FIP x 1/2" FIP x 30"	25
G71036	1/2" FIP x 3/4" MIP x 30"	25
G71037	3/4" FIP x 3/4" MIP x 30"	25
G71038	3/4" FIP x 1/2" MIP x 30"	25
G71039	1/2" FIP x 1/2" MIP x 30"	25
G71040	3/4" MIP x 3/4" MIP x 36"	25
G71041	3/4" MIP x 1/2" MIP x 36"	25
G71042	1/2" MIP x 1/2" MIP x 36"	25
G71043	3/4" FIP x 3/4" FIP x 36"	25
G71044	3/4" FIP x 1/2" FIP x 36"	25
G71045	1/2" FIP x 1/2" FIP x 36"	25

5/8" OD Uncoated w/Fittings (cont.)



- Corrugation extends all the way to the fitting for increased tubing flexibility
- CSA Design certified domestically and internationally for indoor and outdoor use
- 100% leak tested to ensure Safety and Quality and a product you can trust
- Quality flared end fittings to create a metal to metal seal in critical applications
- Durable stainless steel 304. Corrosion resistant.

PART NO.	DESCRIPTION	CTN QTY
G71046	1/2" FIP x 3/4" MIP x 36"	25
G71047	3/4" FIP x 3/4" MIP x 36"	25
G71048	3/4" FIP x 1/2" MIP x 36"	25
G71049	1/2" FIP x 1/2" MIP x 36"	25
G71050	3/4" MIP x 3/4" MIP x 48"	25
G71051	3/4" MIP x 1/2" MIP x 48"	25
G71052	1/2" MIP x 1/2" MIP x 48"	25
G71053	3/4" FIP x 3/4" FIP x 48"	25
G71054	3/4" FIP x 1/2" FIP x 48"	25
G71055	1/2" FIP x 1/2" FIP x 48"	25
G71056	1/2" FIP x 3/4" MIP x 48"	25
G71057	3/4" FIP x 3/4" MIP x 48"	25
G71058	3/4" FIP x 1/2" MIP x 48"	25
G71059	1/2" FIP x 1/2" MIP x 48"	25
G71060	3/4" MIP x 3/4" MIP x 60"	25
G71061	3/4" MIP x 1/2" MIP x 60"	25
G71062	1/2" MIP x 1/2" MIP x 60"	25
G71063	3/4" FIP x 3/4" FIP x 60"	25
G71064	3/4" FIP x 1/2" FIP x 60"	25
G71065	1/2" FIP x 1/2" FIP x 60"	25
G71066	1/2" FIP x 3/4" MIP x 60"	25
G71067	3/4" FIP x 3/4" MIP x 60"	25
G71068	3/4" FIP x 1/2" MIP x 60"	25
G71069	1/2" FIP x 1/2" MIP x 60"	25
G71070	3/4" MIP x 3/4" MIP x 72"	25
G71071	3/4" MIP x 1/2" MIP x 72"	25
G71072	1/2" MIP x 1/2" MIP x 72"	25
G71073	3/4" FIP x 3/4" FIP x 72"	25
G71074	3/4" FIP x 1/2" FIP x 72"	25
G71075	1/2" FIP x 1/2" FIP x 72"	25
G71076	1/2" FIP x 3/4" MIP x 72"	25
G71077	3/4" FIP x 3/4" MIP x 72"	25
G71078	3/4" FIP x 1/2" MIP x 72"	25
G71079	1/2" FIP x 1/2" MIP x 72"	25

5/8" OD Coated w/Fittings



- Corrugation extends all the way to the fitting for increased tubing flexibility
- CSA Design certified domestically and internationally for indoor and outdoor use
- 100% leak tested to ensure Safety and Quality and a product you can trust
- Quality flared end fittings to create a metal to metal seal in critical applications
- Durable stainless steel 304. Corrosion resistant.
- Coated connectors add additional safety in highly corrosive environments or in areas where caustic chemicals are located

PART NO.	DESCRIPTION	CTN QTY
G71100	3/4" MIP x 3/4" MIP x 12"	25
G71101	3/4" MIP x 1/2" MIP x 12"	25
G71102	1/2" MIP x 1/2" MIP x 12"	25
G71103	3/4" FIP x 3/4" FIP x 12"	25
G71104	3/4" FIP x 1/2" FIP x 12"	25
G71105	1/2" FIP x 1/2" FIP x 12"	25
G71106	1/2" FIP x 3/4" MIP x 12"	25
G71107	3/4" FIP x 3/4" MIP x 12"	25
G71108	3/4" FIP x 1/2" MIP x 12"	25
G71109	1/2" FIP x 1/2" MIP x 12"	25
G71110	3/4" MIP x 3/4" MIP x 18"	25
G71111	3/4" MIP x 1/2" MIP x 18"	25
G71112	1/2" MIP x 1/2" MIP x 18"	25
G71113	3/4" FIP x 3/4" FIP x 18"	25
G71114	3/4" FIP x 1/2" FIP x 18"	25
G71115	1/2" FIP x 1/2" FIP x 18"	25
G71116	1/2" FIP x 3/4" MIP x 18"	25
G71117	3/4" FIP x 3/4" MIP x 18"	25
G71118	3/4" FIP x 1/2" MIP x 18"	25
G71119	1/2" FIP x 1/2" MIP x 18"	25
G71120	3/4" MIP x 3/4" MIP x 24"	25
G71121	3/4" MIP x 1/2" MIP x 24"	25
G71122	1/2" MIP x 1/2" MIP x 24"	25
G71123	3/4" FIP x 3/4" FIP x 24"	25
G71124	3/4" FIP x 1/2" FIP x 24"	25
G71125	1/2" FIP x 1/2" FIP x 24"	25
G71126	1/2" FIP x 3/4" MIP x 24"	25
G71127	3/4" FIP x 3/4" MIP x 24"	25
G71128	3/4" FIP x 1/2" MIP x 24"	25
G71129	1/2" FIP x 1/2" MIP x 24"	25
G71130	3/4" MIP x 3/4" MIP x 30"	25
G71131	3/4" MIP x 1/2" MIP x 30"	25
G71132	1/2" MIP x 1/2" MIP x 30"	25
G71133	3/4" FIP x 3/4" FIP x 30"	25
G71134	3/4" FIP x 1/2" FIP x 30"	25
G71135	1/2" FIP x 1/2" FIP x 30"	25
G71136	1/2" FIP x 3/4" MIP x 30"	25
G71137	3/4" FIP x 3/4" MIP x 30"	25
G71138	3/4" FIP x 1/2" MIP x 30"	25
G71139	1/2" FIP x 1/2" MIP x 30"	25
G71140	3/4" MIP x 3/4" MIP x 36"	25
G71141	3/4" MIP x 1/2" MIP x 36"	25
G71142	1/2" MIP x 1/2" MIP x 36"	25

5/8" OD Coated w/Fittings (cont.)



- Corrugation extends all the way to the fitting for increased tubing flexibility
- CSA Design certified domestically and internationally for indoor and outdoor use
- 100% leak tested to ensure Safety and Quality and a product you can trust
- Quality flared end fittings to create a metal to metal seal in critical applications
- Durable stainless steel 304. Corrosion resistant.
- Coated connectors add additional safety in highly corrosive environments or in areas where caustic chemicals are located

PART NO.	DESCRIPTION	CTN QTY
G71143	3/4" FIP x 3/4" FIP x 36"	25
G71144	3/4" FIP x 1/2" FIP x 36"	25
G71145	1/2" FIP x 1/2" FIP x 36"	25
G71146	1/2" FIP x 3/4" MIP x 36"	25
G71147	3/4" FIP x 3/4" MIP x 36"	25
G71148	3/4" FIP x 1/2" MIP x 36"	25
G71149	1/2" FIP x 1/2" MIP x 36"	25
G71150	3/4" MIP x 3/4" MIP x 48"	25
G71151	3/4" MIP x 1/2" MIP x 48"	25
G71152	1/2" MIP x 1/2" MIP x 48"	25
G71153	3/4" FIP x 3/4" FIP x 48"	25
G71154	3/4" FIP x 1/2" FIP x 48"	25
G71155	1/2" FIP x 1/2" FIP x 48"	25
G71156	1/2" FIP x 3/4" MIP x 48"	25
G71157	3/4" FIP x 3/4" MIP x 48"	25
G71158	3/4" FIP x 1/2" MIP x 48"	25
G71159	1/2" FIP x 1/2" MIP x 48"	25
G71160	3/4" MIP x 3/4" MIP x 60"	25
G71161	3/4" MIP x 1/2" MIP x 60"	25
G71162	1/2" MIP x 1/2" MIP x 60"	25
G71163	3/4" FIP x 3/4" FIP x 60"	25
G71164	3/4" FIP x 1/2" FIP x 60"	25
G71165	1/2" FIP x 1/2" FIP x 60"	25
G71166	1/2" FIP x 3/4" MIP x 60"	25
G71167	3/4" FIP x 3/4" MIP x 60"	25
G71168	3/4" FIP x 1/2" MIP x 60"	25
G71169	1/2" FIP x 1/2" MIP x 60"	25
G71170	3/4" MIP x 3/4" MIP x 72"	25
G71171	3/4" MIP x 1/2" MIP x 72"	25
G71172	1/2" MIP x 1/2" MIP x 72"	25
G71173	3/4" FIP x 3/4" FIP x 72"	25
G71174	3/4" FIP x 1/2" FIP x 72"	25
G71175	1/2" FIP x 1/2" FIP x 72"	25
G71176	1/2" FIP x 3/4" MIP x 72"	25
G71177	3/4" FIP x 3/4" MIP x 72"	25
G71178	3/4" FIP x 1/2" MIP x 72"	25
G71179	1/2" FIP x 1/2" MIP x 72"	25

5/8" OD Uncoated w/ Ball Valves



- Corrugation extends all the way to the fitting for increased tubing flexibility
- CSA Design certified domestically and internationally for indoor and outdoor use
- 100% leak tested to ensure Safety and Quality and a product you can trust
- Quality flared end fittings to create a metal to metal seal in critical applications
- Durable stainless steel 304. Corrosion resistant.

PART NO.	DESCRIPTION	CTN QTY
G71200	3/4" FIP x 3/4" FIP Ball x 12"	25
G71201	1/2" FIP x 3/4" FIP Ball x 12"	25
G71202	3/4" FIP x 1/2" FIP Ball x 12"	25
G71203	1/2" FIP x 1/2" FIP Ball x 12"	25
G71204	3/4" MIP x 3/4" FIP Ball x 12"	25
G71205	1/2" MIP x 3/4" FIP Ball x 12"	25
G71206	3/4" MIP x 1/2" FIP Ball x 12"	25
G71207	1/2" MIP x 1/2" FIP Ball x 12"	25
G71208	3/4" FIP x 3/4" FIP Ball x 18"	25
G71209	1/2" FIP x 3/4" FIP Ball x 18"	25
G71210	3/4" FIP x 1/2" FIP Ball x 18"	25
G71211	1/2" FIP x 1/2" FIP Ball x 18"	25
G71212	3/4" MIP x 3/4" FIP Ball x 18"	25
G71213	1/2" MIP x 3/4" FIP Ball x 18"	25
G71214	3/4" MIP x 1/2" FIP Ball x 18"	25
G71215	1/2" MIP x 1/2" FIP Ball x 18"	25
G71216	3/4" FIP x 3/4" FIP Ball x 24"	25
G71217	1/2" FIP x 3/4" FIP Ball x 24"	25
G71218	3/4" FIP x 1/2" FIP Ball x 24"	25
G71219	1/2" FIP x 1/2" FIP Ball x 24"	25
G71220	3/4" MIP x 3/4" FIP Ball x 24"	25
G71221	1/2" MIP x 3/4" FIP Ball x 24"	25
G71222	3/4" MIP x 1/2" FIP Ball x 24"	25
G71223	1/2" MIP x 1/2" FIP Ball x 24"	25
G71224	3/4" FIP x 3/4" FIP Ball x 30"	25
G71225	1/2" FIP x 3/4" FIP Ball x 30"	25
G71226	3/4" FIP x 1/2" FIP Ball x 30"	25
G71227	1/2" FIP x 1/2" FIP Ball x 30"	25
G71228	3/4" MIP x 3/4" FIP Ball x 30"	25
G71229	1/2" MIP x 3/4" FIP Ball x 30"	25
G71230	3/4" MIP x 1/2" FIP Ball x 30"	25
G71231	1/2" MIP x 1/2" FIP Ball x 30"	25
G71232	3/4" FIP x 3/4" FIP Ball x 36"	25
G71233	1/2" FIP x 3/4" FIP Ball x 36"	25
G71234	3/4" FIP x 1/2" FIP Ball x 36"	25
G71235	1/2" FIP x 1/2" FIP Ball x 36"	25
G71236	3/4" MIP x 3/4" FIP Ball x 36"	25
G71237	1/2" MIP x 3/4" FIP Ball x 36"	25
G71238	3/4" MIP x 1/2" FIP Ball x 36"	25
G71239	1/2" MIP x 1/2" FIP Ball x 36"	25
G71240	3/4" FIP x 3/4" FIP Ball x 48"	25
G71241	1/2" FIP x 3/4" FIP Ball x 48"	25
G71242	3/4" FIP x 1/2" FIP Ball x 48"	25
G71243	1/2" FIP x 1/2" FIP Ball x 48"	25

5/8" OD Uncoated w/ Ball Valves (cont.)



- Corrugation extends all the way to the fitting for increased tubing flexibility
- CSA Design certified domestically and internationally for indoor and outdoor use
- 100% leak tested to ensure Safety and Quality and a product you can trust
- Quality flared end fittings to create a metal to metal seal in critical applications
- Durable stainless steel 304. Corrosion resistant.

PART NO.	DESCRIPTION	CTN QTY
G71244	3/4" MIP x 3/4" FIP Ball x 48"	25
G71245	1/2" MIP x 3/4" FIP Ball x 48"	25
G71246	3/4" MIP x 1/2" FIP Ball x 48"	25
G71247	1/2" MIP x 1/2" FIP Ball x 48"	25
G71248	3/4" FIP x 3/4" FIP Ball x 60"	25
G71249	1/2" FIP x 3/4" FIP Ball x 60"	25
G71250	3/4" FIP x 1/2" FIP Ball x 60"	25
G71251	1/2" FIP x 1/2" FIP Ball x 60"	25
G71252	3/4" MIP x 3/4" FIP Ball x 60"	25
G71253	1/2" MIP x 3/4" FIP Ball x 60"	25
G71254	3/4" MIP x 1/2" FIP Ball x 60"	25
G71255	1/2" MIP x 1/2" FIP Ball x 60"	25
G71256	3/4" FIP x 3/4" FIP Ball x 72"	25
G71257	1/2" FIP x 3/4" FIP Ball x 72"	25
G71258	3/4" FIP x 1/2" FIP Ball x 72"	25
G71259	1/2" FIP x 1/2" FIP Ball x 72"	25
G71260	3/4" MIP x 3/4" FIP Ball x 72"	25
G71261	1/2" MIP x 3/4" FIP Ball x 72"	25
G71262	3/4" MIP x 1/2" FIP Ball x 72"	25
G71263	1/2" MIP x 1/2" FIP Ball x 72"	25
G71264	1/2" MIP x 3/4" FIP Angle Ball x 36"	25
G71265	1/2" MIP x 3/4" FIP Angle Ball x 48"	25
G71266	1/2" MIP x 3/4" FIP Angle Ball x 60"	25
G71267	1/2" MIP x 3/4" FIP Angle Ball x 72"	25

5/8" OD Coated w/ Ball Valves



- Corrugation extends all the way to the fitting for increased tubing flexibility
- CSA Design certified domestically and internationally for indoor and outdoor use
- 100% leak tested to ensure Safety and Quality and a product you can trust
- Quality flared end fittings to create a metal to metal seal in critical applications
- Durable stainless steel 304. Corrosion resistant.
- Coated connectors add additional safety in highly corrosive environments or in areas where caustic chemicals are located

PART NO.	DESCRIPTION	CTN QTY
G71300	3/4" FIP x 3/4" FIP Ball x 12"	25
G71304	3/4" MIP x 3/4" FIP Ball x 12"	25
G71305	1/2" MIP x 3/4" FIP Ball x 12"	25
G71307	1/2" MIP x 1/2" FIP Ball x 12"	25
G71308	3/4" FIP x 3/4" FIP Ball x 18"	25
G71312	3/4" MIP x 3/4" FIP Ball x 18"	25
G71313	1/2" MIP x 3/4" FIP Ball x 18"	25
G71315	1/2" MIP x 1/2" FIP Ball x 18"	25
G71316	3/4" FIP x 3/4" FIP Ball x 24"	25
G71320	3/4" MIP x 3/4" FIP Ball x 24"	25
G71321	1/2" MIP x 3/4" FIP Ball x 24"	25
G71323	1/2" MIP x 1/2" FIP Ball x 24"	25
G71324	3/4" FIP x 3/4" FIP Ball x 30"	25
G71328	3/4" MIP x 3/4" FIP Ball x 30"	25
G71329	1/2" MIP x 3/4" FIP Ball x 30"	25
G71331	1/2" MIP x 1/2" FIP Ball x 30"	25
G71332	3/4" FIP x 3/4" FIP Ball x 36"	25
G71336	3/4" MIP x 3/4" FIP Ball x 36"	25
G71337	1/2" MIP x 3/4" FIP Ball x 36"	25
G71339	1/2" MIP x 1/2" FIP Ball x 36"	25
G71340	3/4" FIP x 3/4" FIP Ball x 48"	25
G71344	3/4" MIP x 3/4" FIP Ball x 48"	25
G71345	1/2" MIP x 3/4" FIP Ball x 48"	25
G71347	1/2" MIP x 1/2" FIP Ball x 48"	25
G71348	3/4" FIP x 3/4" FIP Ball x 60"	25
G71352	3/4" MIP x 3/4" FIP Ball x 60"	25
G71353	1/2" MIP x 3/4" FIP Ball x 60"	25
G71356	3/4" FIP x 3/4" FIP Ball x 72"	25
G71360	3/4" MIP x 3/4" FIP Ball x 72"	25
G71361	1/2" MIP x 3/4" FIP Ball x 72"	25

1/2" OD Uncoated w/Fittings



- Corrugation extends all the way to the fitting for increased tubing flexibility
- CSA Design certified domestically and internationally for indoor and outdoor use
- 100% leak tested to ensure Safety and Quality and a product you can trust
- Quality flared end fittings to create a metal to metal seal in critical applications
- Durable stainless steel 304. Corrosion resistant.

PART NO.	DESCRIPTION	CTN QTY
G72000	1/2" MIP x 1/2" MIP x 12"	25
G72001	1/2" MIP x 3/8" MIP x 12"	25
G72002	3/8" MIP x 3/8" MIP x 12"	25
G72003	1/2" FIP x 1/2" FIP x 12"	25
G72004	1/2" FIP x 3/8" FIP x 12"	25
G72005	1/2" FIP x 1/2" MIP x 12"	25
G72006	1/2" FIP x 3/8" MIP x 12"	25
G72007	3/8" FIP x 1/2" MIP x 12"	25
G72008	1/2" MIP x 1/2" MIP x 18"	25
G72009	1/2" MIP x 3/8" MIP x 18"	25
G72010	3/8" MIP x 3/8" MIP x 18"	25
G72011	1/2" FIP x 1/2" FIP x 18"	25
G72012	1/2" FIP x 3/8" FIP x 18"	25
G72013	1/2" FIP x 1/2" MIP x 18"	25
G72014	1/2" FIP x 3/8" MIP x 18"	25
G72015	3/8" FIP x 1/2" MIP x 18"	25
G72016	1/2" MIP x 1/2" MIP x 24"	25
G72017	1/2" MIP x 3/8" MIP x 24"	25
G72018	3/8" MIP x 3/8" MIP x 24"	25
G72019	1/2" FIP x 1/2" FIP x 24"	25
G72020	1/2" FIP x 3/8" FIP x 24"	25
G72021	1/2" FIP x 1/2" MIP x 24"	25
G72022	1/2" FIP x 3/8" MIP x 24"	25
G72023	3/8" FIP x 1/2" MIP x 24"	25
G72024	1/2" MIP x 1/2" MIP x 30"	25
G72025	1/2" MIP x 3/8" MIP x 30"	25
G72026	3/8" MIP x 3/8" MIP x 30"	25
G72027	1/2" FIP x 1/2" FIP x 30"	25
G72028	1/2" FIP x 3/8" FIP x 30"	25
G72029	1/2" FIP x 1/2" MIP x 30"	25
G72030	1/2" FIP x 3/8" MIP x 30"	25
G72031	3/8" FIP x 1/2" MIP x 30"	25
G72032	1/2" MIP x 1/2" MIP x 36"	25
G72033	1/2" MIP x 3/8" MIP x 36"	25
G72034	3/8" MIP x 3/8" MIP x 36"	25
G72035	1/2" FIP x 1/2" FIP x 36"	25
G72036	1/2" FIP x 3/8" FIP x 36"	25
G72037	1/2" FIP x 1/2" MIP x 36"	25
G72038	1/2" FIP x 3/8" MIP x 36"	25
G72039	3/8" FIP x 1/2" MIP x 36"	25
G72040	1/2" MIP x 1/2" MIP x 48"	25
G72041	1/2" MIP x 3/8" MIP x 48"	25
G72042	3/8" MIP x 3/8" MIP x 48"	25
G72043	1/2" FIP x 1/2" FIP x 48"	25
G72044	1/2" FIP x 3/8" FIP x 48"	25
G72045	1/2" FIP x 1/2" MIP x 48"	25

1/2" OD Uncoated w/Fittings (cont.)



- Corrugation extends all the way to the fitting for increased tubing flexibility
- CSA Design certified domestically and internationally for indoor and outdoor use
- 100% leak tested to ensure Safety and Quality and a product you can trust
- Quality flared end fittings to create a metal to metal seal in critical applications
- Durable stainless steel 304. Corrosion resistant.

PART NO.	DESCRIPTION	CTN QTY
G72046	1/2" FIP x 3/8" MIP x 48"	25
G72047	3/8" FIP x 1/2" MIP x 48"	25
G72048	1/2" MIP x 1/2" MIP x 60"	25
G72049	1/2" MIP x 3/8" MIP x 60"	25
G72050	3/8" MIP x 3/8" MIP x 60"	25
G72051	1/2" FIP x 1/2" FIP x 60"	25
G72052	1/2" FIP x 3/8" FIP x 60"	25
G72053	1/2" FIP x 1/2" MIP x 60"	25
G72054	1/2" FIP x 3/8" MIP x 60"	25
G72055	3/8" FIP x 1/2" MIP x 60"	25
G72056	1/2" MIP x 1/2" MIP x 72"	25
G72057	1/2" MIP x 3/8" MIP x 72"	25
G72058	3/8" MIP x 3/8" MIP x 72"	25
G72059	1/2" FIP x 1/2" FIP x 72"	25
G72060	1/2" FIP x 3/8" FIP x 72"	25
G72061	1/2" FIP x 1/2" MIP x 72"	25
G72062	1/2" FIP x 3/8" MIP x 72"	25
G72063	3/8" FIP x 1/2" MIP x 72"	25
G72064	1/2" MIP x 3/8" FIP Angle x 36"	25
G72065	1/2" MIP x 3/8" FIP Angle x 48"	25
G72066	1/2" MIP x 3/8" FIP Angle x 72"	25

1/2" OD Coated w/Fittings



- Corrugation extends all the way to the fitting for increased tubing flexibility
- CSA Design certified domestically and internationally for indoor and outdoor use
- 100% leak tested to ensure Safety and Quality and a product you can trust
- Quality flared end fittings to create a metal to metal seal in critical applications
- Durable stainless steel 304. Corrosion resistant.
- Coated connectors add additional safety in highly corrosive environments or in areas where caustic chemicals are located

1/2" OD Coated w/Fittings (cont.)



- Corrugation extends all the way to the fitting for increased tubing flexibility
- CSA Design certified domestically and internationally for indoor and outdoor use
- 100% leak tested to ensure Safety and Quality and a product you can trust
- Quality flared end fittings to create a metal to metal seal in critical applications
- Durable stainless steel 304. Corrosion resistant.
- Coated connectors add additional safety in highly corrosive environments or in areas where caustic chemicals are located

PART NO.	DESCRIPTION	CTN QTY
G72100	1/2" MIP x 1/2" MIP x 12"	25
G72101	1/2" MIP x 3/8" MIP x 12"	25
G72102	3/8" MIP x 3/8" MIP x 12"	25
G72103	1/2" FIP x 1/2" FIP x 12"	25
G72104	1/2" FIP x 3/8" FIP x 12"	25
G72105	1/2" FIP x 1/2" MIP x 12"	25
G72106	1/2" FIP x 3/8" MIP x 12"	25
G72107	3/8" FIP x 1/2" MIP x 12"	25
G72108	1/2" MIP x 1/2" MIP x 18"	25
G72109	1/2" MIP x 3/8" MIP x 18"	25
G72110	3/8" MIP x 3/8" MIP x 18"	25
G72111	1/2" FIP x 1/2" FIP x 18"	25
G72112	1/2" FIP x 3/8" FIP x 18"	25
G72113	1/2" FIP x 1/2" MIP x 18"	25
G72114	1/2" FIP x 3/8" MIP x 18"	25
G72115	3/8" FIP x 1/2" MIP x 18"	25
G72116	1/2" MIP x 1/2" MIP x 24"	25
G72117	1/2" MIP x 3/8" MIP x 24"	25
G72118	3/8" MIP x 3/8" MIP x 24"	25
G72119	1/2" FIP x 1/2" FIP x 24"	25
G72120	1/2" FIP x 3/8" FIP x 24"	25
G72121	1/2" FIP x 1/2" MIP x 24"	25
G72122	1/2" FIP x 3/8" MIP x 24"	25
G72123	3/8" FIP x 1/2" MIP x 24"	25
G72124	1/2" MIP x 1/2" MIP x 30"	25
G72125	1/2" MIP x 3/8" MIP x 30"	25
G72126	3/8" MIP x 3/8" MIP x 30"	25
G72127	1/2" FIP x 1/2" FIP x 30"	25
G72128	1/2" FIP x 3/8" FIP x 30"	25
G72129	1/2" FIP x 1/2" MIP x 30"	25
G72130	1/2" FIP x 3/8" MIP x 30"	25
G72131	3/8" FIP x 1/2" MIP x 30"	25
G72132	1/2" MIP x 1/2" MIP x 36"	25
G72133	1/2" MIP x 3/8" MIP x 36"	25
G72134	3/8" MIP x 3/8" MIP x 36"	25
G72135	1/2" FIP x 1/2" FIP x 36"	25
G72136	1/2" FIP x 3/8" FIP x 36"	25
G72137	1/2" FIP x 1/2" MIP x 36"	25
G72138	1/2" FIP x 3/8" MIP x 36"	25
G72139	3/8" FIP x 1/2" MIP x 36"	25
G72140	1/2" MIP x 1/2" MIP x 48"	25
G72141	1/2" MIP x 3/8" MIP x 48"	25
G72142	3/8" MIP x 3/8" MIP x 48"	25
G72143	1/2" FIP x 1/2" FIP x 48"	25
G72144	1/2" FIP x 3/8" FIP x 48"	25
G72145	1/2" FIP x 1/2" MIP x 48"	25

PART NO.	DESCRIPTION	CTN QTY
G72146	1/2" FIP x 3/8" MIP x 48"	25
G72147	3/8" FIP x 1/2" MIP x 48"	25
G72148	1/2" MIP x 1/2" MIP x 60"	25
G72149	1/2" MIP x 3/8" MIP x 60"	25
G72150	3/8" MIP x 3/8" MIP x 60"	25
G72151	1/2" FIP x 1/2" FIP x 60"	25
G72152	1/2" FIP x 3/8" FIP x 60"	25
G72153	1/2" FIP x 1/2" MIP x 60"	25
G72154	1/2" FIP x 3/8" MIP x 60"	25
G72155	3/8" FIP x 1/2" MIP x 60"	25

1/2" OD Uncoated with Ball Valves



- Corrugation extends all the way to the fitting for increased tubing flexibility
- CSA Design certified domestically and internationally for indoor and outdoor use
- 100% leak tested to ensure Safety and Quality and a product you can trust
- Quality flared end fittings to create a metal to metal seal in critical applications
- Durable stainless steel 304. Corrosion resistant.

PART NO.	DESCRIPTION	CTN QTY
G72200	1/2" MIP x 1/2" FIP Ball x 12"	25
G72201	3/8" MIP x 1/2" FIP Ball x 12"	25
G72202	1/2" FIP x 1/2" FIP Ball x 12"	25
G72203	3/8" FIP x 1/2" FIP Ball x 12"	25
G72204	1/2" MIP x 1/2" FIP Ball x 18"	25
G72205	3/8" MIP x 1/2" FIP Ball x 18"	25
G72206	1/2" FIP x 1/2" FIP Ball x 18"	25
G72207	3/8" FIP x 1/2" FIP Ball x 18"	25
G72208	1/2" MIP x 1/2" FIP Ball x 24"	25
G72209	3/8" MIP x 1/2" FIP Ball x 24"	25
G72210	1/2" FIP x 1/2" FIP Ball x 24"	25
G72211	3/8" FIP x 1/2" FIP Ball x 24"	25
G72212	1/2" MIP x 1/2" FIP Ball x 30"	25
G72213	3/8" MIP x 1/2" FIP Ball x 30"	25
G72214	1/2" FIP x 1/2" FIP Ball x 30"	25
G72215	3/8" FIP x 1/2" FIP Ball x 30"	25
G72216	1/2" MIP x 1/2" FIP Ball x 36"	25
G72217	3/8" MIP x 1/2" FIP Ball x 36"	25
G72218	1/2" FIP x 1/2" FIP Ball x 36"	25
G72219	3/8" FIP x 1/2" FIP Ball x 36"	25
G72220	1/2" MIP x 1/2" FIP Ball x 48"	25
G72221	3/8" MIP x 1/2" FIP Ball x 48"	25
G72222	1/2" FIP x 1/2" FIP Ball x 48"	25
G72223	3/8" FIP x 1/2" FIP Ball x 48"	25
G72224	1/2" MIP x 1/2" FIP Ball x 60"	25
G72225	3/8" MIP x 1/2" FIP Ball x 60"	25
G72226	1/2" FIP x 1/2" FIP Ball x 60"	25
G72227	3/8" FIP x 1/2" FIP Ball x 60"	25
G72228	1/2" MIP x 1/2" FIP Ball x 72"	25
G72229	3/8" MIP x 1/2" FIP Ball x 72"	25
G72230	1/2" FIP x 1/2" FIP Ball x 72"	25
G72231	3/8" FIP x 1/2" FIP Ball x 72"	25

1/2" OD Coated w/Ball Valves



- Corrugation extends all the way to the fitting for increased tubing flexibility
- CSA Design certified domestically and internationally for indoor and outdoor use
- 100% leak tested to ensure Safety and Quality and a product you can trust
- Quality flared end fittings to create a metal to metal seal in critical applications
- Durable stainless steel 304. Corrosion resistant.
- Coated connectors add additional safety in highly corrosive environments or in areas where caustic chemicals are located

PART NO.	DESCRIPTION	CTN QTY
G72300	1/2" MIP x 1/2" FIP Ball x 12"	25
G72302	1/2" FIP x 1/2" FIP Ball x 12"	25
G72304	1/2" MIP x 1/2" FIP Ball x 18"	25
G72306	1/2" FIP x 1/2" FIP Ball x 18"	25
G72308	1/2" MIP x 1/2" FIP Ball x 24"	25
G72310	1/2" FIP x 1/2" FIP Ball x 24"	25
G72312	1/2" MIP x 1/2" FIP Ball x 30"	25
G72314	1/2" FIP x 1/2" FIP Ball x 30"	25
G72316	1/2" MIP x 1/2" FIP Ball x 36"	25
G72318	1/2" FIP x 1/2" FIP Ball x 36"	25
G72320	1/2" MIP x 1/2" FIP Ball x 48"	25
G72322	1/2" FIP x 1/2" FIP Ball x 48"	25
G72324	1/2" MIP x 1/2" FIP Ball x 60"	25
G72326	1/2" FIP x 1/2" FIP Ball x 60"	25
G72328	1/2" MIP x 1/2" FIP Ball x 72"	25
G72330	1/2" FIP x 1/2" FIP Ball x 72"	25
G72332	1/2" MIP x 1/2" FIP Angle Ball x 24"	25
G72333	1/2" MIP x 1/2" FIP Angle Ball x 36"	25
G72334	1/2" MIP x 1/2" FIP Angle Ball x 48"	25
G72335	1/2" MIP x 1/2" FIP Angle Ball x 72"	25

1/2" OD Black Coated



- For use with gas logs
- Corrugation extends all the way to the fitting for increased tubing flexibility
- CSA Design certified domestically and internationally for indoor and outdoor use
- 100% leak tested to ensure Safety and Quality and a product you can trust
- Quality flared end fittings to create a metal to metal seal in critical applications
- Durable stainless steel 304. Corrosion resistant.
- Coated connectors add additional safety in highly corrosive environments or in areas where caustic chemicals are located.

PART NO.	DESCRIPTION	CTN QTY
G74103	1/2" FIP x 1/2" FIP x 12"	25
G74105	1/2" FIP x 1/2" MIP x 12"	25
G74111	1/2" FIP x 1/2" FIP x 18"	25
G74113	1/2" FIP x 1/2" MIP x 18"	25
G74119	1/2" FIP x 1/2" FIP x 24"	25
G74121	1/2" FIP x 1/2" MIP x 24"	25
G74127	1/2" FIP x 1/2" FIP x 30"	25
G74129	1/2" FIP x 1/2" MIP x 30"	25
G74135	1/2" FIP x 1/2" FIP x 36"	25
G74137	1/2" FIP x 1/2" MIP x 36"	25

3/8" OD Black Coated



- For use with gas logs
- Corrugation extends all the way to the fitting for increased tubing flexibility
- CSA Design certified domestically and internationally for indoor and outdoor use
- 100% leak tested to ensure Safety and Quality and a product you can trust
- Quality flared end fittings to create a metal to metal seal in critical applications
- Durable stainless steel 304. Corrosion resistant.
- Coated connectors add additional safety in highly corrosive environments or in areas where caustic chemicals are located.

PART NO.	DESCRIPTION	CTN QTY
G73101	1/2" FIP x 1/2" FIP x 12"	25
G73108	1/2" FIP x 1/2" FIP x 18"	25
G73115	1/2" FIP x 1/2" FIP x 24"	25
G73122	1/2" FIP x 1/2" FIP x 30"	25
G73129	1/2" FIP x 1/2" FIP x 36"	25

Nominal Connector Series (I.D. Inches)	Straight Length Capacity - Ptu Per Hr (W) 0.64 Sp Gr.1000 Btu Per Cu Ft (37.2 MJ Per Cu Meter) Gas at @ 0.5 inch Water Column (124 Pa) Pressure Drop		
	12"	24"	36"
1/4	48000	40000	33400
3/8	102000	85000	71000
1/2	180000	150000	125000

NOTE: When using 0.2 inch water column pressure drop, capacity can be determined by multiplying the figures above by 0.632.

A	
Adapter	31
Faucet	38
Faucet To Garden Hose	38
Sweat Male	31
Aerators	36
Chicago Style Faucet	37
Counter Display	37
Non-Slotted .5 GPM	37
Non-Slotted Full Flow	36
Non-Slotted Reduced Flow	37
Six Pack Tubes For Counter Display	37
Slotted 2.2 GPM Flow	36
Slotted Full Flow	36
Snap Fitting	37
Swivel Spray	37
Vandal-Proof	37
Air Gap	28
Dishwasher Kit	28
Air Vent, Plumb Aire	28
American Standard	7
Ballcock Repair Parts	7
Seat Disc Tank Ball	4
Aqualine Replacement Handles	38
Assembly	26
ABS Pop-Up	26
Brass Pop-up	26
Brass Pop-up, Replacement Parts	26
Chrome Plated ABS Pop-Up	26
Delta Style Spray	33
Lift & Lock Pop-Up	26
B	
Backflow Preventer/Sewer Stopper	41
Ballcock	28
And Flush Valve Repair Parts for Mansfield	8
Coupling Nut And Locknut	28
Mansfield Style	7
Mansfield Style, With Float Rod	7
Repair Parts For American Standard	7
Repair Parts For Coast	7
Repair Parts For Fluidmaster	8
Repair Parts For Hoover/Amerline	8
Repair Parts For Kohler	8
Bar Plug, Brass	36
Basin	20, 29
And Tub Stopper	20
Cock Locknut	28
Crumb Cups	36
Faucet	47
Self-Closing and Shower Valve	48
Nut	29
Basket Strainer	28, 34
ABS Body And Post	35
Chrome Plated Brass Duo	35
Deep Cup	35
Deep Junior Duo	35
Duo	34
Economy Replacement	34
Junior Duo	35
Locknuts And Washers	28
Quick Fit Stainless Steel	35
Shallow Cup Duo	34
Stainless Steel Deep Cup	35
Stainless Steel Duo	35
Twist And Lock	34
Bathcocks	17
Bath Drain	19
Adapter Bushing	19
Lift And Turn	19
Toe Touch	19
Bath Kits	22
Schedule 40 Direct Waste	22
With One-Hole Face Plates	22
With Two-Hole Face Plates	22
Bath Supplies, Offset	16
Bathtub Protectors	19
Bath Waste Kits	23
Conversion	24
Rough-In, Schedule 40	24
Rough-In, Schedule 40 With Test Kits	25
Schedule 40 Bath Waste	23
With One-Hole Face Plates	23
With Two-Hole Face Plates	23
Bead Chain And Coupling	27
Brass Float Rod	6
Brass Overflow Tube	6
Brass P.O. Plug Drain	27
Bubbler	47
Drinking Fountain	47
Drinking Fountain With Face Guard	47
Retrofit Kit	47
Bushing	17
Adapter, For Bath Drain	19
Brass Trap	17
Twin Elbow And Face	17
Buttons	39
Faucet Index	39
Single Handle Replacement	39
C	
Ceiling Plates, Floor and	40
Flexible	40
Cleanout And Relief Valve	41
Sewer	41
Sewer Popper™	41
Closet Bolts	8
"Bucket Of Bolts"	9
Bulk Packed	10
Component Parts	10
Custom Packed	9
Elite Packs	11
Enduro	8
Enduro Jar Display	8
Snap-Off	11
With Tinnerman Nuts	9
Closet Screws	11
Closet Spuds	5
Friction Rings	5
Washers	5
Coast Ballcock Repair Parts	7
Commercial	27

Grid Drain Without Overflow Holes	27	Basket Strainer	34
Handicap Drain With Elbow	27	Kitchen Hose And Spray.....	33
Lav Drain.....	27	Replacement Handles.....	38
Connectors, Gas (see Gas Connectors)	49	Stopper.....	20
Connector, Waste	30	Fittings, Double Slip	30
Conversion Kits	24	Flanges	14
Bath Waste.....	24	Jumbo Shower Bar	14
With Cross Bar	24	Shower Arm.....	15
Copper Refill Tube	6	Shower Rod.....	14
Cover	32	Flappers	4
Cock Hole.....	32	2 Way, with Separate Trunion.....	4
Plastic Faucet Hole.....	32	Carded Blue Vinyl.....	4
Repair Plates, Stainless Steel.....	41	Jumbo ToTo Style.....	4
Trap.....	42	Flip-It	20
Cross Handle Self Closing Valve	47	Tub Stopper	20
Crumb Cups, Sink and Basin	36	Float, Ball	4
D		Floor & Ceiling Plates	40
Delex Replacement Handles	38	Flexible.....	40
Delta	38	Flush Valve	6
Faucet Index Buttons	39	Douglas.....	7
Replacement Handles.....	38	Mansfield #210	7
Dispenser, Soap and Lotion	33	Pipe Support.....	27
Diverter Spouts	17	Plastic Coast	7
Add-A-Shower.....	16	Shank Washer.....	6
And Extensions.....	17	Friction Rings	30
Chrome Plated	17	Brass.....	30
Chrome Plated Slip-On, With Polished Brass Knob.....	18	Closet Spud.....	5
Double Slip Fittings	30	G	
Drain, Three Prong Protector	36	Garbage Disposal	36
Drinking Fountain	47	Splash Guard	36
Bubbler and Cartridge.....	47	Stopper.....	36
Bubbler With Face Guard	47	Gas Connectors	49
Self-Closing.....	47	Black Coated	58
Drop Ear	31	1/2" OD	58
Elbow	31	3/8" OD	58
Transition Elbow	31	Coated.....	49
E		1/2" OD with Ball Valves.....	57
Eljer Replacement Handles	38	1/2" OD with Fittings.....	56
Escutcheons	39	3/8" OD with Ball Valves.....	51
Plastic Shallow Flange.....	40	3/8" OD with Fittings.....	49
Poly Bagged	40	5/8" OD with Ball Valves.....	54
Sure Grip.....	39	5/8" OD with Fittings.....	52
F		Uncoated.....	49
Face Plate Gasket And Shoe Gasket	18	1/2" OD with Ball Valves.....	57
Faucet	32	1/2" OD with Fittings.....	55
Adapters.....	38	3/8" OD with Ball Valves.....	50
Bar Tap	32	3/8" OD with Fittings.....	49
Basin	47	5/8" OD with Ball Valves.....	53
Self-Closing and Shower Valve	48	5/8" OD with Fittings.....	51
Index Buttons	39	Gasket	18
Laundry Tray.....	47	Face Plate	18
Long Reach Bar Tap	32	Shoe	18
Service Sink	48	Tank to Bowl.....	12
Single Kitchen Sink.....	47	Wax	13
Wall Mount Sink.....	47	Grab Bar	25
Faucet Handles, Porcelain and Handicap	32	Fastening Systems.....	26
Faucet Hole Cover, Plastic	32	With Concealed Snap-On Flange	25, 26
Faucet Seats Kit	32	With Exposed Flange.....	25
Faucet To Garden Hose Adapters	38	Grid Drain	19
Fit-All	20	Chrome Plated Body With Screw.....	19

Commercial, Without Overflow Holes.....	27	Brass Bar.....	36
H		Tray.....	36
Hangers	34	Plumb Aire Air Vent	28
Adjustable Lavatory.....	34	Plumbing Connectors	43
Lavatory.....	34	Braided Nylon.....	44
Mop, for Service Sink.....	48	Flexible Stainless-Steel.....	43
Sink.....	34	Porcelain And Handicap Faucet Handles	32
Hose And Spray	33	Protector, Three Prong Drain	36
Kitchen (Fit All).....	33	Provent	28
Rinse-Quik.....	33	P-Trap	27
I		Chrome Plated PVC.....	27
In-Sink-Erator Rubber Hush Cushion	36	Commercial, with Cleanout.....	27
K		PVC Shower Pan Liner Cement	15
Kit	31	R	
Assorted Washer.....	31	Radiant Seal Sponge Rubber Closet Gasket	13
O-Ring.....	31	Relief Valve, Cleanout And	41
Solid Brass Bibb Screw Assortment.....	31	Sewer.....	41
Undermount Sink Installation.....	33	Sewer Popper™.....	41
L		Replacement Handles	38
Lavatory	33	Aqualine.....	38
Adjustable Hanger.....	34	Delex.....	38
Hangers.....	34	Delta.....	38
Legs.....	33	Eljer.....	38
Lav Drain	27	Fit-All.....	38
Commercial.....	27	Mixet.....	38
Handicap Style.....	27	Moen.....	39
Lift Wire	6	Peerless.....	38
Brass.....	6	Sears.....	38
Brass Guide.....	6	Stanadyne.....	39
Locknut	28	Valley.....	38
Ballcock Coupling Nut And.....	28	Rinse-Quik Hose and Spray	33
Basin Cock.....	28	Rosettes	28
Basket Strainer, And Washers.....	28	Rubber Hush Cushion, In-Sink-Erator	36
Lugs, Sink	33	S	
M		Screws, Solid Brass Bibb Assortment Kit	31
Mansfield Style	7	Sears Replacement Handles	38
Ballcock.....	7	Sewer Stopper/Backflow Preventer	41
Ballcock and Flush Valve Repair Parts.....	8	Shims	
Ballcock With Float Rod.....	7	Closet Wedge Shims.....	8
Marvel Rings, Sweat Male Adapter	31	Flexible Super Shims.....	9
Mixet Replacement Handles	38	Rigid Super Shims.....	9
Moen	39	Shoe Gasket and Face Plate Gasket	18
Replacement Handles.....	39	Shower	15
Single Handle Replacement Buttons.....	39	Curtain Pin.....	15
N		Diverter Valve.....	16
Nut	28	Pan Liner.....	15
Basin.....	29	Pan Liner Cement, PVC.....	15
Plastic Lavatory Supply.....	29	Utility.....	17
Plastic Slip Joint.....	28	Shower, Add-A-	16
Split.....	29	Accessories.....	16
O		Code Pattern.....	16
O-Ring Kit And Pick	31	Complete Unit.....	16
Overflow Plates	18	Diverter Spout & Riser.....	16
P		D-Style.....	16
Peerless	38	Less Oval Shower Rod.....	16
Faucet Index Buttons.....	39	Shower Arm	15
Replacement Handles.....	38	And Flange with Set Screw.....	15
Pipe Support, Flush Valve	27	And Kits.....	15
Plastic Flow Restrictor	15	Flange.....	15
Plug	36	Heavy Adjustable.....	15

Plastic.....	15	Basin And Tub.....	20
Shower Curtain Pin.....	15	Fit-All.....	20
Shower Elbow, Brass For Fiberglass Shower Stall.....	17	Flip-It Tub.....	20
Shower Head.....	14	Garbage Disposal.....	36
Adjustable Massage.....	15	Kitchen Sink.....	36
Adjustable Plastic.....	15	Pop-Up Basin.....	20
Brass Aerating Water Saver.....	14	Strainer.....	34
Deluxe.....	14	ABS Body And Post Basket.....	35
Octagonal.....	15	Beehive Urinal, Cast Brass.....	35
Vandal Proof.....	14	Chrome Plated Brass Duo Basket.....	35
Shower Rod.....	14	Deep Cup Basket.....	35
Adjustable Aluminum.....	14	Deep Junior Duo Basket.....	35
Aluminum.....	14	Duo Basket.....	34
Aluminum, with Holders.....	14	Duo, CP Brass.....	34
Contoured.....	14	Economy Replacement Basket.....	34
Sink.....	33	Fit-All Basket.....	34
Connection Washer.....	29	Flat Duplex.....	35
Crumb Cups.....	36	Flat Top Grid.....	34
Hangers.....	34	Flexible Hair.....	35
Kitchen Stopper.....	36	Junior Duo Basket.....	35
Laundry Tray Faucet.....	47	Quick Fit Stainless Steel Basket.....	35
Lugs.....	33	Shallow Cup Duo Basket.....	34
Service.....	48	Stainless Steel Deep Cup Basket.....	35
Faucet.....	48	Stainless Steel Duo Basket.....	35
Hose & Hose Bracket.....	48	Twist And Lock Basket.....	34
Mop Hanger.....	48	Supply Nut, Plastic Lavatory.....	29
Single Kitchen Sink Faucet.....	47	Supply Stops.....	46
Undermount Installation Kit.....	33	Supply Tubes.....	45
Wall Mount Faucet.....	47	Chrome Plated Flexible Basin.....	45
Slip Joint.....	29	Chrome Plated Flexible Tank.....	45
Cone, Washer.....	30	Flexible Tank.....	45
Nut.....	29	PEX.....	45
Nut And Washer.....	29	PEX With Ferrule.....	45
Rough Brass, Nut.....	29	Sweat Male Adapter/Marvel Rings.....	31
Tee.....	30	T	
Washer.....	29	Tank.....	3
Soap And Lotion Dispenser, Chrome Plated.....	33	Ball and Seat Discs.....	3
Spacer.....	13	Cover, Toilet Tank.....	8
Air Gap.....	28	Replacement.....	8
Closet Bend.....	13	Tank to Bowl.....	11
Foam.....	13	Bolt Set.....	11
Styrofoam Closet Flange.....	13	Components.....	12
Splash Guard, Garbage Disposal.....	36	Gasket.....	12
Split Nut.....	29	Offset Bolts.....	12
Sponge Closet Gaskets.....	6	Set.....	11
Spouts.....	17	Tank to Bowl Bolt Kit.....	12
Diverter.....	17	For American Standard.....	12
Telescoping Tub.....	18	For Mansfield.....	12
Tub.....	18	Tri-Bolt Tank.....	12
Spray.....	33	Tri-Tank, American Standard.....	12
Delta Style Assembly.....	33	Tank Trip Lever	
Kitchen (Fit All).....	33	American Standard.....	2
Rinse-Quik.....	33	Crane.....	2
Stanadyne.....	39	Eljer.....	3
Replacement Handles.....	39	Eljer Touch Flush Assembly.....	3
Single Handle Replacement Buttons.....	39	Fit-All Economy.....	2
Standard Waste Overflow.....	19	Fit-All Front Mount.....	2
One-Hole.....	19	Fit-All Heavy Duty.....	2
Two-Hole.....	19	Fit-All Premium.....	2
Stopper.....	20	Fit-All Side Mount.....	2

Kohler.....	3
Mansfield.....	3
ToTo Chrome Plated.....	3
Ultrafit.....	3
Universal Rundle/Sears.....	3
Western Pottery.....	3
Tissue Rollers.....	27
Trap Covers.....	42
Trap Primer Tailpiece.....	27
Tray Plug.....	36
Trip Lever Trim.....	24
Tub and Basin Stopper.....	20
Tub Drain	
Friction Lift.....	19
Roman.....	20
Tub Spouts.....	18
Chrome Plated.....	18
Telescoping.....	18
Tub Trip Levers With Spring.....	18
U	
Urinal	
Strainer, Cast Brass Beehive.....	35
V	
Valley.....	38
Replacement Handles.....	38
W	
Washer.....	6
Aqua Seal.....	6
Assorted Kit.....	31
Basket Strainer.....	28
Beveled Ballcock Shank.....	6
Beveled Bibb.....	6
Cone Slip Joint.....	30
Flanged Poly Tailpiece.....	30
Flat Bibb.....	6
Home Kit.....	30
Sink Connection.....	29
Slip Joint.....	29
Waste And Overflow.....	24
Aluminum Bar.....	24
Test Kits.....	24
Waste Connector.....	30
Water Volume Control.....	15
Wax Gaskets.....	13

PART NO.	PG #
A01001	36
A01002	36
A01003	36
A01004	36
A01005	36
A01006	36
A01007	36
A01008	36
A01010	36
A01011	37
A01012	37
A01013	37
A01014	37
A01015	37
A01016	37
A01017	37
A01018	37
A01020	37
A01021	37
A01022	37
A01023	37
A01024	37
A01025	37
A01026	37
A01027	37
A01029	37
A01030	38
A01031	38
A01032	38
A01033	38
A01034	38
A01035	38
A01036	37
A01037	37
A01040	38
A01041	38
A01050	37
A01051	37
A01060	37
A01061	37
A01062	37
A01900	37
A01901	37
A10001	28
A10100	28
A10150	28
A10200	28
A10901	28

PART NO.	PG #
B02049	35
B02050	35
B02051	36
B02052	35
B02060	36
B02102	35
B02103	35
B03010	34
B03015	34
B07001	22
B07002	22
B07003	22
B07004	22
B07005	22
B07006	22
B07007	22
B07008	22
B07010	23
B07011	23
B07012	23
B07013	23
B07014	23
B07015	23
B07016	23
B07017	23
B07020	22
B07021	22
B07022	22
B07023	22
B07024	22
B07025	22
B07027	22
B07030	23
B07031	23
B07032	23
B07033	23
B07034	23
B07035	23
B07036	23
B07037	23
B07038	22
B07039	22
B07040	22
B07041	22
B07042	22
B07043	22
B07044	22
B07045	22

PART NO.	PG #
B07046	22
B07047	22
B07048	22
B07049	22
B07050	23
B07051	23
B07052	23
B07053	23
B07054	23
B07055	23
B07056	23
B07057	23
B07058	23
B07059	23
B07060	23
B07061	23
B07070	25
B07071	24
B07072	25
B07073	24
B07074	24
B07075	24
B07076	24
B07077	24
B07101	22
B07102	22
B07103	22
B07104	22
B07105	22
B07106	22
B07107	22
B07108	22
B07110	23
B07111	23
B07111S	19
B07112	23
B07113	23
B07114	23
B07114S	19
B07115	23
B07116	23
B07117	23
B07120	22
B07121	22
B07122	22
B07123	22
B07124	22
B07125	22

PART NO.	PG #
B07126	22
B07127	22
B07130	23
B07131	23
B07132	23
B07133	23
B07134	23
B07135	23
B07136	23
B07137	23
B07138	22
B07139	22
B07140	22
B07141	22
B07142	22
B07143	22
B07144	22
B07146	22
B07147	22
B07148	22
B07149	22
B07150	23
B07151	23
B07152	23
B07153	23
B07154	23
B07155	23
B07156	23
B07157	23
B07158	23
B07159	23
B07160	23
B07161	23
B07170	25
B07171	24
B07172	25
B07173	24
B07200	24
B07201	24
B07202	24
B07203	24
B07210	24
B07219	19
B07220T	19
B07221T	19
B07374	24
B07375	24
B07376	24

PART NO.	PG #
B07377	24
B07470	25
B07472	25
B07476	25
B07477	25
B08071	24
B10080	28
B10081	28
B10090	28
B10091	28
B10092	28
B10093	28
B10094	28
B10100	29
B10102	29
B10103	29
B10104	29
B10105	29
B10110	28
B10111	28
B10195	27
B10200	32
B10201	32
B10202	32
B10203	32
B40000	31
B40001	32
B40002	32
B40003	32
B40004	32
B40005	32
B40006	32
B40007	32
B40008	32
B40009	32
B40010	32
B40011	32
B40012	32
B40013	32
B40014	32
B40015	32
B40017	32
B40018	32
B40019	32
B40020	32
B40021	32
B40023	32
B40024	32

PART NO.	PG #
B40025	32
B40026	32
B40027	32
B40028	32
B40030	32
B40031	32
B40032	32
B40033	32
B40034	32
B40035	32
B40036	32
B40101	31
B45010	32
B45014	32
B45200	47
B45215	47
B45216	47
B45217	47
B45218	47
B45220	47
B49001	17
B49002	17
B49010	17
B49011	17
B49012	17
B49013	17
B49020	16
B49021	16
B49022	16
B51005	24
B51006	24
B51007	24
B51008	24
B51009	24
B51010	24
B51011	24
B51014	24
B51015	24
B51019	24
B51020	24
B55000	31
B55001	31
B55002	31
B55003	31
B55004	31
B55005	31
B55006	31
B55007	31

PART NO.	PG #
B55008	31
B55009	31
B55050	31
B55100	31
B55101	31
B55103	31
B55104	31
B55150	17
B60001	16
B60002	16
C02000	9
C02000B	10
C02001	9
C02001B	10
C02002	9
C02002B	10
C02003	9
C02003B	10
C02004	9
C02004B	10
C02005	9
C02005B	10
C02010	9
C02010B	10
C02011	9
C02011B	10
C02012	9
C02012B	10
C02013	9
C02013B	10
C02014	9
C02014B	10
C02015	9
C02015B	10
C02020	9
C02020B	10
C02021	9
C02021B	10
C02022	9
C02022B	10
C02023	9
C02023B	10
C02024	9
C02024B	10
C02025	9
C02025B	10
C02029	9
C02029B	10

PART NO.	PG #
C02030	9
C02030B	10
C02031	9
C02031B	10
C02032	9
C02032B	10
C02033	9
C02033B	10
C02034	9
C02034B	10
C02040	11
C02041	11
C02045	11
C02046	11
C02050	8
C02075	12
C02100	11
C02103	11
C02104	11
C02105	11
C02106	11
C02200	11
C02201	11
C02202	11
C02203	11
C02210	11
C02211	11
C02300	11
C02301	11
C02302	11
C02303	11
C02310	11
C02311	11
C02401	9
C02402	9
C02403	9
C02404	9
C02405	9
C02421	9
C02422	9
C02423	9
C02424	9
C02800	10
C02801	10
C02802	10
C02803	10
C02804	10
C02805	10

PART NO.	PG #
C02807	10
C02808	10
C02809	10
C02810	10
C02811	10
C02812	10
C02813	10
C02814	10
C02815	10
C02820	10
C02821	10
C02822	10
C02823	10
C02824	10
C02825	10
C02830	10
C02832	10
C02850	10
C02851	10
C02852	10,12
C02853	10
C02860	10
C02861	10
C02862	10
C02863	10
C02864	10
C02865	10
C02900	10
C02901	10
C02987	11
C02989	11
C02990	9
C02992	11
C02993	11
C02994	11
C02995	11
C02996	11
C02997	11
C02998	11
C02999	11
C03200	11
C03201	11
C03202	11
C03203	11
C03210	11
C03211	11
C03212	11
C03213	11

PART NO.	PG #
C03240	11
C03250	11
C03251	11
C03252	11
C03253	11
C03260	12
C03265	12
C03270	12
C03271	12
C03272	12
C03280	12
C03300	12
C03301	12
C03302	12
C03303	12
C03304	12
C03305	12
C03306	12
C03800	12
C03801	12
C03803	12
C03804	12
C03805	12
C03807	12
C03810	12
C04000	4
C04001	4
C04002	4
C04004	4
C04005	4
C04006	4
C04007	4
C04008	4
C04010	4
C04011	4
C04013	5
C04014	4
C04015	5
C04016	5
C04017	5
C04019	3
C04020	3
C04021	3
C04024	4
C04025	4
C04027	5
C04028	4
C04029	4

PART NO.	PG #
C04030	3
C04031	3
C04032	5
C04033	5
C04034	5
C05040	4
C05041	4
C05042	6
C05045	6
C05046	6
C05047	6
C05048	6
C05049	6
C05051	6
C05052	6
C05053	6
C05054	6
C05056	6
C05057	6
C05070	7
C05071	7
C05073	7
C05080	28
C05081	28
C05082	28
C05200	7
C27125	5
C27126	5
C27127	5
C27134	5
C27150	5
C27150A	5
C27200	5
C27201	5
C27202	5
C27301	5
C27302	5
C27303	5
C27304	5
C27305	5
C27308	5
C27309	5
C27310	5
C27321	5
C27322	5
C27323	5
C27324	5
C27325	5

PART NO.	PG #
C27328	5
C74105	30
CB2001	9
CB2002	9
CB2003	9
CB2004	9
CB2005	9
CB2011	9
CB2012	9
CB2013	9
CB2014	9
CB2015	9
CB2021	9
CB2022	9
CB2023	9
CB2024	9
CB2025	9
CB2030	9
CB2031	9
CB2032	9
CB2033	9
CB2034	9
CB2040	11
CB2041	11
CB2045	11
CB2046	11
CJ1003	8
D01001	17
D01002	17
D01003	17
D01004	17
D01005	18
D01008	17
D01009	17
D01010	17
D01011	17
D01015	17
D01016	18
D01017	18
D01018	18
D01020	18
D01021	18
D01022	18
D01023	18
D01024	17
D01025	17
D01026	18
D01027	18

PART NO.	PG #	PART NO.	PG #	PART NO.	PG #	PART NO.	PG #
D01028	18	E05150	39	F04125	40	F39700	27
D01029	18	E06050	39	F04150	40	F39800	27
D01030	17	E06075	39	F04200	40	G12012	25
D01031	17	E06100	39	F04250	40	G12016	25
D01032	18	E06125	39	F04300	40	G12018	25
D01035	18	E06150	39	F04350	40	G12024	25
D01040	17	E06375	39	F04375	40	G12030	25
D01041	17	E07025	39	F04400	40	G12032	25
D01042	17	E07050	39	F04500	40	G12036	25
D02002	28	E07375	39	F04600	40	G12042	25
D18062	36	E08125	39	F04800	40	G12048	25
D18063	36	E08138	39	F04999	40	G12112	25
D40000	20	E08150	39	F06050	40	G12116	25
D40001	20	E15050	40	F06075	40	G12118	25
D40002	20	E15052	40	F06099	40	G12124	25
D45000	35	E15075	40	F06100	40	G12130	25
D45001	35	E15375	40	F06124	40	G12132	25
D70100	27	E16050	40	F06125	40	G12136	25
D70101	27	E16075	40	F06150	40	G12142	25
D70102	27	E16150	40	F06200	40	G12148	25
D70103	27	E16151	40	F06201	40	G12212	25
D70104	27	E16200	40	F06250	40	G12216	25
D70105	27	E16375	40	F06251	40	G12218	25
E01049	40	F01050	40	F06300	40	G12224	25
E01050	39	F01075	40	F06301	40	G12230	25
E01074	40	F01100	40	F06351	40	G12232	25
E01075	39	F01125	40	F06375	40	G12236	25
E01100	39	F01150	40	F06400	40	G12242	25
E01125	39	F01375	40	F06401	40	G12248	25
E01150	39	F02050	40	F06500	40	G12312	26
E01375	39	F02075	40	F06600	40	G12316	26
E02050	39	F02100	40	F06800	40	G12318	26
E02075	39	F02125	40	F07050	41	G12324	26
E02100	39	F02150	40	F07075	41	G12330	26
E02125	39	F02200	40	F07099	41	G12332	26
E02150	39	F02375	40	F07100	41	G12336	26
E02152	39	F03050	40	F07124	41	G12342	26
E02200	39	F03075	40	F07125	41	G12348	26
E02375	39	F03100	40	F07150	41	G12998	26
E03125	39	F03125	40	F07200	41	G12999	26
E03150	39	F03150	40	F07201	41	G13001	13
E03200	39	F03200	40	F07300	41	G13002	13
E03225	40	F03250	40	F07375	41	G13003	13
E03250	40	F03300	40	F39001	47	G13004	13
E04125	39	F03375	40	F39002	47	G13005	13
E04150	39	F04050	40	F39004	47	G13012	25
E04200	39	F04075	40	F39005	47	G13016	25
E05125	39	F04100	40	F39010	48	G13018	25

PART NO.	PG #
G13024	25
G13030	25
G13032	25
G13036	25
G13042	25
G13048	25
G13112	25
G13116	25
G13118	25
G13124	25
G13130	25
G13132	25
G13136	25
G13142	25
G13148	25
G13212	25
G13216	25
G13218	25
G13224	25
G13230	25
G13232	25
G13236	25
G13242	25
G13248	25
G13312	26
G13316	26
G13318	26
G13324	26
G13330	26
G13332	26
G13336	26
G13342	26
G13348	26
G13500	6
G13516	6
G13534	6
G13601	6
G13616	6
G13634	6
G13638	6
G70000	49
G70001	49
G70002	49
G70003	49
G70004	49
G70005	49
G70006	49
G70007	49

PART NO.	PG #
G70008	49
G70009	49
G70010	49
G70011	49
G70012	49
G70013	49
G70014	49
G70015	49
G70016	49
G70017	49
G70018	49
G70019	49
G70020	49
G70021	49
G70022	49
G70023	49
G70024	49
G70025	49
G70026	49
G70027	49
G70028	49
G70029	49
G70030	49
G70031	49
G70032	49
G70033	49
G70034	49
G70035	49
G70036	49
G70037	49
G70038	49
G70039	49
G70040	49
G70041	49
G70042	49
G70043	49
G70044	49
G70045	49
G70046	49
G70047	49
G70048	49
G70049	49
G70050	49
G70051	49
G70052	49
G70053	49
G70054	49
G70055	49

PART NO.	PG #
G70100	49
G70101	49
G70102	49
G70103	49
G70104	49
G70105	49
G70106	49
G70107	49
G70108	49
G70109	49
G70110	49
G70111	49
G70112	49
G70113	49
G70114	49
G70115	49
G70116	49
G70117	49
G70118	49
G70119	49
G70120	49
G70121	49
G70122	49
G70123	50
G70124	50
G70125	50
G70126	50
G70127	50
G70128	50
G70129	50
G70130	50
G70131	50
G70132	50
G70133	50
G70134	50
G70135	50
G70136	50
G70137	50
G70138	50
G70139	50
G70140	50
G70141	50
G70142	50
G70143	50
G70144	50
G70145	50
G70146	50
G70147	50

PART NO.	PG #
G70148	50
G70149	50
G70150	50
G70151	50
G70152	50
G70153	50
G70154	50
G70155	50
G70200	50
G70201	50
G70202	50
G70203	50
G70204	50
G70205	50
G70206	50
G70207	50
G70208	50
G70209	50
G70210	50
G70211	50
G70212	50
G70213	50
G70214	50
G70215	50
G70216	50
G70217	50
G70218	50
G70219	50
G70220	50
G70221	50
G70222	50
G70223	50
G70224	50
G70225	50
G70226	50
G70227	50
G70228	50
G70229	50
G70230	50
G70231	50
G70232	50
G70233	50
G70234	50
G70235	50
G70236	50
G70237	50
G70300	51
G70301	51

PART NO.	PG #
G70302	51
G70303	51
G70304	51
G70305	51
G70306	51
G70307	51
G70308	51
G70309	51
G70310	51
G70311	51
G70312	51
G70313	51
G70314	51
G70315	51
G70316	51
G70317	51
G70318	51
G70319	51
G70320	51
G70321	51
G70322	51
G70323	51
G70324	51
G70325	51
G70326	51
G70327	51
G70328	51
G70329	51
G70330	51
G70331	51
G70332	51
G70333	51
G70334	51
G70335	51
G70336	51
G70337	51
G71000	51
G71001	51
G71002	51
G71003	51
G71004	51
G71005	51
G71006	51
G71007	51
G71008	51
G71009	51
G71010	51
G71011	51

PART NO.	PG #
G71012	51
G71013	51
G71014	51
G71015	51
G71016	51
G71017	51
G71018	51
G71019	51
G71020	51
G71021	51
G71022	51
G71023	51
G71024	51
G71025	51
G71026	51
G71027	51
G71028	51
G71029	51
G71030	51
G71031	51
G71032	51
G71033	51
G71034	51
G71035	51
G71036	51
G71037	51
G71038	51
G71039	51
G71040	51
G71041	51
G71042	51
G71043	51
G71044	51
G71045	51
G71046	52
G71047	52
G71048	52
G71049	52
G71050	52
G71051	52
G71052	52
G71053	52
G71054	52
G71055	52
G71056	52
G71057	52
G71058	52
G71059	52

PART NO.	PG #
G71060	52
G71061	52
G71062	52
G71063	52
G71064	52
G71065	52
G71066	52
G71067	52
G71068	52
G71069	52
G71070	52
G71071	52
G71072	52
G71073	52
G71074	52
G71075	52
G71076	52
G71077	52
G71078	52
G71079	52
G71100	52
G71101	52
G71102	52
G71103	52
G71104	52
G71105	52
G71106	52
G71107	52
G71108	52
G71109	52
G71110	52
G71111	52
G71112	52
G71113	52
G71114	52
G71115	52
G71116	52
G71117	52
G71118	52
G71119	52
G71120	52
G71121	52
G71122	52
G71123	52
G71124	52
G71125	52
G71126	52
G71127	52

PART NO.	PG #
G71128	52
G71129	52
G71130	52
G71131	52
G71132	52
G71133	52
G71134	52
G71135	52
G71136	52
G71137	52
G71138	52
G71139	52
G71140	52
G71141	52
G71142	52
G71143	53
G71144	53
G71145	53
G71146	53
G71147	53
G71148	53
G71149	53
G71150	53
G71151	53
G71152	53
G71153	53
G71154	53
G71155	53
G71156	53
G71157	53
G71158	53
G71159	53
G71160	53
G71161	53
G71162	53
G71163	53
G71164	53
G71165	53
G71166	53
G71167	53
G71168	53
G71169	53
G71170	53
G71171	53
G71172	53
G71173	53
G71174	53
G71175	53

PART NO.	PG #
G71176	53
G71177	53
G71178	53
G71179	53
G71200	53
G71201	53
G71202	53
G71203	53
G71204	53
G71205	53
G71206	53
G71207	53
G71208	53
G71209	53
G71210	53
G71211	53
G71212	53
G71213	53
G71214	53
G71215	53
G71216	53
G71217	53
G71218	53
G71219	53
G71220	53
G71221	53
G71222	53
G71223	53
G71224	53
G71225	53
G71226	53
G71227	53
G71228	53
G71229	53
G71230	53
G71231	53
G71232	53
G71233	53
G71234	53
G71235	53
G71236	53
G71237	53
G71238	53
G71239	53
G71240	53
G71241	53
G71242	53
G71243	53

PART NO.	PG #
G71244	54
G71245	54
G71246	54
G71247	54
G71248	54
G71249	54
G71250	54
G71251	54
G71252	54
G71253	54
G71254	54
G71255	54
G71256	54
G71257	54
G71258	54
G71259	54
G71260	54
G71261	54
G71262	54
G71263	54
G71264	54
G71265	54
G71266	54
G71267	54
G71300	54
G71304	54
G71305	54
G71307	54
G71308	54
G71312	54
G71313	54
G71315	54
G71316	54
G71320	54
G71321	54
G71323	54
G71324	54
G71328	54
G71329	54
G71331	54
G71332	54
G71336	54
G71337	54
G71339	54
G71340	54
G71344	54
G71345	54
G71347	54

PART NO.	PG #
G71348	54
G71352	54
G71353	54
G71356	54
G71360	54
G71361	54
G72000	55
G72001	55
G72002	55
G72003	55
G72004	55
G72005	55
G72006	55
G72007	55
G72008	55
G72009	55
G72010	55
G72011	55
G72012	55
G72013	55
G72014	55
G72015	55
G72016	55
G72017	55
G72018	55
G72019	55
G72020	55
G72021	55
G72022	55
G72023	55
G72024	55
G72025	55
G72026	55
G72027	55
G72028	55
G72029	55
G72030	55
G72031	55
G72032	55
G72033	55
G72034	55
G72035	55
G72036	55
G72037	55
G72038	55
G72039	55
G72040	55
G72041	55

PART NO.	PG #
G72042	55
G72043	55
G72044	55
G72045	55
G72046	55
G72047	55
G72048	55
G72049	55
G72050	55
G72051	55
G72052	55
G72053	55
G72054	55
G72055	55
G72056	55
G72057	55
G72058	55
G72059	55
G72060	55
G72061	55
G72062	55
G72063	55
G72064	55
G72065	55
G72066	55
G72100	56
G72101	56
G72102	56
G72103	56
G72104	56
G72105	56
G72106	56
G72107	56
G72108	56
G72109	56
G72110	56
G72111	56
G72112	56
G72113	56
G72114	56
G72115	56
G72116	56
G72117	56
G72118	56
G72119	56
G72120	56
G72121	56
G72122	56

PART NO.	PG #
G72123	56
G72124	56
G72125	56
G72126	56
G72127	56
G72128	56
G72129	56
G72130	56
G72131	56
G72132	56
G72133	56
G72134	56
G72135	56
G72136	56
G72137	56
G72138	56
G72139	56
G72140	56
G72141	56
G72142	56
G72143	56
G72144	56
G72145	56
G72146	56
G72147	56
G72148	56
G72149	56
G72150	56
G72151	56
G72152	56
G72153	56
G72154	56
G72155	56
G72200	57
G72201	57
G72202	57
G72203	57
G72204	57
G72205	57
G72206	57
G72207	57
G72208	57
G72209	57
G72210	57
G72211	57
G72212	57
G72213	57
G72214	57

PART NO.	PG #
G72215	57
G72216	57
G72217	57
G72218	57
G72219	57
G72220	57
G72221	57
G72222	57
G72223	57
G72224	57
G72225	57
G72226	57
G72227	57
G72228	57
G72229	57
G72230	57
G72231	57
G72300	57
G72302	57
G72304	57
G72306	57
G72308	57
G72310	57
G72312	57
G72314	57
G72316	57
G72318	57
G72320	57
G72322	57
G72324	57
G72326	57
G72328	57
G72330	57
G72332	57
G72333	57
G72334	57
G72335	57
G73101	58
G73108	58
G73115	58
G73122	58
G73129	58
G74103	58
G74105	58
G74111	58
G74113	58
G74119	58
G74121	58

PART NO.	PG #
G74127	58
G74129	58
G74135	58
G74137	58
H54001	38
H54002	38
H54003	38
H54007	32
H54008	32
H54010	38
H54011	38
H54012	38
H54013	38
H54014	38
H54015	38
H54017	38
H54018	38
H54025	39
H54026	39
H54027	39
H54028	39
H54029	39
H54030	38
H54040	39
H54041	39
H54060	39
H54061	39
J37124	27
J37150	27
J40150	31
J40151	31
J40153	31
J40155	30
K52001	33
K52002	33
K52003	33
K52004	33
K52005	33
K52010	33
K53001	33
K53002	33
K53003	33
K53004	33
K53005	33
K53006	33
K53007	33
K53008	33
K53055	33

PART NO.	PG #
K53056	33
K53057	33
K53058	33
K53060	33
K53077	33
K55006	33
K55007	33
L47001	47
L47002	47
L47003	47
L47004	47
L56020	34
L56021	34
L56022	34
L56023	34
L56024	34
L56025	34
L56026	34
L56027	34
L65001	33
M05001	48
M05003	48
M05005	48
O25199	31
O25200	31
O25202	6
O25203	6
O25204	6
O25205	6
O25206	6
O25207	6
O25208	6
O25209	6
O25210	6
O25302	6
O25303	6
O25304	6
O25305	6
O25306	6
O25307	6
O25308	6
O25309	6
O25310	6
P21100	28
P21101	28
P21102	28
P21103	28

PART NO.	PG #
P21104	28
P21107	28
P21150	28
P35000	26
P35001	26
P35003	26
P35004	26
P35005	26
P35021	27
P35022	27
P35023	27
P35025	27
P35026	27
P35041	26
P35056	19
P35057	19
P35060	19
P35061	19
P35062	19
P35063	19
P35064	19
P35066	19
P35067	19
P35070	20
P35077	19
P35125	20
P35150	20
P35158	20
P35159	36
P35160	20
P35161	20
P35162	36
P35163	36
P35165	36
P35166	36
P35167	36
P35170	20
P35175	20
P35180	35
P35900	26
P35901	26
P35902	26
P35904	26
P35905	26
P35906	26
P35907	26
P35908	26
P35909	26

PART NO.	PG #
P35910	26
P35911	26
P35912	26
P35913	26
P36002	20
P36003	20
P36004	20
P36102	27
P36103	27
S01001	14
S01002	14
S01003	14
S01004	14
S01005	14
S01008	14
S01009	14
S01010	14
S01013	14
S01014	14
S01015	14
S01016	15
S01020	15
S01025	15
S01030	15
S01032	15
S01035	15
S01038	15
S01039	15
S01040	15
S01041	15
S01042	15
S01044	15
S01045	15
S01049	15
S01050	17
S01060	15
S01061	15
S01070	16
S01080	15
S02015	14
S02016	14
S02055	14
S02056	14
S02057	14
S02058	14
S02059	14
S02066	14
S02069	14

PART NO.	PG #
S02070	14
S02071	14
S02072	14
S02073	14
S02074	14
S02100	15
S02150	14
S02151	14
S02152	14
S02190	14
S02191	14
S02193	14
S02300	14
S02999	26
S03220	19
S03222	19
S04020	45
S04021	45
S04022	45
S04023	45
S04024	45
S04025	45
S04026	45
S04027	45
S04028	45
S04029	45
S04030	45
S04031	45
S04032	45
S04101	45
S04102	45
S04103	45
S04104	45
S04105	45
S04106	45
S04107	45
S04108	45
S04121	45
S04123	45
S04124	45
S04125	45
S04127	45
S04128	45
S04200	43
S04201	43
S04202	43
S04203	43
S04204	43

PART NO.	PG #
S04205	43
S04206	43
S04207	43
S04208	43
S04209	43
S04210	43
S04211	43
S04212	43
S04213	43
S04214	43
S04215	43
S04216	43
S04217	43
S04218	43
S04219	43
S04220	43
S04221	43
S04222	43
S04223	43
S04224	43
S04225	43
S04226	43
S04227	43
S04228	43
S04229	43
S04230	43
S04231	43
S04232	43
S04233	44
S04234	44
S04235	44
S04236	44
S04237	44
S04238	44
S04239	44
S04240	44
S04241	44
S04242	44
S04243	44
S04244	44
S04245	44
S04246	44
S04247	44
S04248	44
S04249	44
S04250	44
S04255	43
S04260	44

PART NO.	PG #
S04268	44
S04269	44
S04270	44
S04280	43
S04285	43
S04400	44
S04401	44
S04402	44
S04403	44
S04404	44
S04405	44
S04406	44
S04407	44
S04408	44
S04409	44
S04410	44
S04411	44
S04412	44
S04413	44
S04414	44
S04415	44
S04416	44
S04417	44
S04418	44
S04419	44
S04420	44
S04421	44
S04422	44
S04423	44
S04424	44
S04430	44
S04440	44
S04450	44
S04455	44
S04500	42
S04501	42
S04502	42
S04503	42
S04504	42
S04505	42
S04506	42
S04507	42
S04508	42
S04509	42
S04510	42
S05100	48
S05101	48
S05102	48

PART NO.	PG #
S05105	47
S08003	47
S08008	47
S08012	47
S08018	47
S08020	33
S08030	47
S08031	47
S08032	47
S10067	16
S10068	16
S10069	16
S10070	16
S10071	16
S10072	16
S10073	16
S10074	16
S10075	16
S10076	16
S10077	16
S10078	16
S10079	17
S10080	16
S10081	16
S10082	16
S10083	16
S10200	46
S10201	46
S10202	46
S10203	46
S10204	46
S10205	46
S10206	46
S10207	46
S10208	46
S10209	46
S10210	46
S10211	46
S10212	46
S10213	46
S10214	46
S10215	46
S10216	46
S10217	46
S10218	46
S10219	46
S10220	46
S10221	46

PART NO.	PG #
S10222	46
S10223	46
S10224	46
S10225	46
S10226	46
S10227	46
S10228	46
S10229	46
S10230	46
S10231	46
S10232	46
S10233	46
S10234	46
S10235	46
S10236	46
S10237	46
S10238	46
S10239	46
S10240	46
S10241	46
S10242	46
S10243	46
S10244	46
S10247	46
S10248	46
S10249	46
S10250	46
S10251	46
S10252	46
S10253	46
S10260	46
S10261	46
S10262	46
S10263	46
S10264	46
S10265	46
S10266	46
S10267	46
S10275	46
S10280	46
S10300	46
S10301	46
S10302	46
S10303	46
S10310	46
S10311	46
S10312	46
S10313	46

PART NO.	PG #
S10314	46
S10315	46
S12005	13
S13130	13
S13140	13
S13240	13
S14001	34
S14002	34
S14003	34
S14004	35
S14005	34
S14006	34
S14007	34
S14008	35
S14010	34
S14011	34
S14014	35
S14030	35
S14103	34
S14250	35
S14251	35
S14606	35
S55349	48
S55350	48
S55351	48
S55352	48
S55353	48
S55354	48
S55902	8
S55903	8
S55950	8
S55951	8
S55952	9
S55953	9
S58050	33
S58051	33
S58052	33
S58053	33
S58101	33
S62100	41
S62101	41
S62304	41
S63200	41
S63300	41
S63400	41
S99100	15
S994050	15
S995040	15

PART NO.	PG #
S996050	15
T01001	2
T01002	2
T01005	2
T01010	3
T01012	3
T01016	3
T01020	3
T01030	2
T01034	2
T01040	3
T01042	2
T01048	2
T01050	2
T01060	2
T01062	2
T01064	2
T01066	3
T01068	2
T01070	2
T01072	3
T01074	2
T01080	3
T01081	3
T01099	2
T01100	3
T01200	2
T01201	2
T02005	8
T02006	8
T02007	8
T02020	7
T02021	7
T02022	7
T02023	7
T02024	7
T02025	4
T02026	7
T02027	7
T02028	6
T02035	7
T02036	7
T02037	7
T02038	7
T02039	7
T02050	8
T02051	8
T02052	8

PART NO.	PG #
T02053	8
T02060	8
T02062	8
T02063	8
T02064	8
T02065	8
T02066	7
T02067	8
T02075	7
T03008	7
T03009	7
T05002	18
T05003	18
T05010	18
T05011	18
T05012	18
T05013	18
T05021	18
T05023	19
T05024	19
T05025	18
T05026	18
T05029	18
T10014	19
T10016	19
T10216	19
T73001	41
T73002	41
T73003	41
T73004	41
T73815	41
T73816	41
T73817	41
T73818	41
T74001	30
T74002	30
T74003	30
T74004	30
T74005	30
T74006	30
T74010	27
T74011	27
T75000	30
T75001	30
T75125	30
T75150	30
T75151	30
T75250	30

PART NO.	PG #
T76125	30
T76150	30
T76151	30
T76250	30
T77012	29
T77013	29
T77014	29
T77020	29
T77125	29
T77138	29
T77150	29
T77151	29
T77152	29
T77200	29
T78012	29
T78013	29
T78014	29
T78020	29
T78125	29
T78150	29
T78151	29
T78152	29
T78200	29
T79000	29
T79125	29
T79150	29
T79151	29
T79152	30
T79200	29
T79201	29
T80125	29
T80150	29
T80151	29
T80200	29
T81150	30
T82125	29
T82150	29
T83150	28
T84125	29
T84150	29
T84151	29
T84200	29
T85050	30
T85051	30
T85052	30
T85053	30
T85054	30
T85055	30

PART NO.	PG #
T85056	6
T85057	6
T85125	28
T85150	28
T86050	30
T86052	30
T86053	30
T86054	30
T86055	30



SECTION C - MISC. PLUMBING SPECIALTIES

VOLUME VI



Quality
Products *for*
the Plumbing
Professional

Repair	1-2
Test Caps & Plugs	3-4
Flexible Transition Couplings	5
Dishwasher/Washing Machine Parts	6
Dryer Vents.....	7-8
Tape.....	9
Pipe Sleeving/Sand Cloth	10
Rubber Insulation	11-14
Poly Insulation.....	15-17
Insulation Tools/Dielectric Union.....	18
Water Heater Connectors.....	19
Water Heater Supplies.....	20
Pressure Gauges	20-22
Tubing	23
Stud Guards	24-26
Hooks & Nails.....	27
Pipe Strap/Clamps.....	28
Hanger Tape/Packing.....	29
Lead Supplies/Roofing Repair	30
Service Sink Repair	31
Bolts & Screws	32
Washers/Clamps	33
Conduit Hanger	34
Water Meter Supplies	35
Meter Boxes.....	36-37
Boxes	37
Product Index.....	38-40
Part Number Index.....	41-46

Snap-Ease Access Panel



- Can be painted or wallpapered
- Constructed of high-impact white ABS
- Easily installed to eliminate unsightly drywall repairs
- Provides for future access to plumbing or wiring behind wall
- 5/8" depth

PART NO.	SIZE	CTN QTY
A04006	6" x 9"	10
A05008	8" x 8"	10
A05014	14" x 14"	10
A05027	14" x 27"	6

Plastic Access Panel



- Beveled edges
- Indented screw holes in corners

PART NO.	SIZE	CTN QTY
A04012	12" x 12"	20

Stainless Steel Repair Clamp



Two Bolt



One Bolt

- Plated lug, carriage bolt and nuts for corrosion protection
- 301 stainless steel clamp with neoprene gaskets for up to 180°F
- Long neck carriage bolts for easy installation

3" One Bolt			
PART NO.	IPS/SCH 40	CTS NOM	CTN QTY
R30375	3/8"	1/2"	6
R30050	1/2"	3/4"	6
R30075	3/4"	1"	6
R30100	1"	1 1/4"	6
R30125	1 1/4"	1 1/2"	6
R30150	1 1/2"	-	6
R30200	2"	-	6
R30250	2 1/2"	-	1
R30300	3"	-	1
R30400	4"	-	1
R30600	6"	-	1
6" Two Bolt			
PART NO.	IPS/SCH 40	CTS NOM	CTN QTY
R60375	3/8"	1/2"	6
R60050	1/2"	3/4"	6
R60075	3/4"	1"	6
R60100	1"	1 1/4"	6
R60125	1 1/4"	1 1/2"	6
R60150	1 1/2"	-	6
R60200	2"	-	6
R60250	2 1/2"	-	1
R60300	3"	-	1
R60400	4"	-	1
R60600	6"	-	1

Malleable Iron Compression Coupling



- EPDM gaskets
- Metal friction ring
- Maximum 125 PSI at 120°F
- Pipe ends must be restrained
- Fits both IPS and Schedule 40 pipe
- Galvanized for corrosion protection

Short Pattern			
PART NO.	IPS	BODY LENGTH	CTN QTY
C10050	1/2"	2 1/4"	12
C10075	3/4"	2 1/2"	12
C10100	1"	2 3/4"	12

Long Pattern			
PART NO.	IPS	BODY LENGTH	CTN QTY
C11050	1/2"	3 3/8"	12
C11075	3/4"	3 5/8"	12
C11100	1"	3 7/8"	12
C11125	1 1/4"	4 1/8"	6
C11150	1 1/2"	4 5/16"	6
C11200	2"	4 1/2"	6
C11250	2 1/2"	6 3/4"	6
C11300	3"	7"	3
C11400	4"	8 1/8"	2

Bronze Compression Coupling



- EPDM gaskets
- Bronze coated brass bodies and nuts
- Maximum 125 PSI at temperatures up to 180°F
- Pipe ends must be restrained on both ends
- For use on galvanized pipe and copper tubing (check sizes)

3" Length			
PART NO.	CTS	IPS	CTN QTY
C14050	1/2"	3/8"	24
C14075	3/4"	1/2"	12
C14100	1"	3/4"	12

LEAD FREE			
PART NO.	CTS	IPS	CTN QTY
C14205	1/2"	3/8"	24
C14206	3/4"	1/2"	12
C14207	1"	3/4"	12

5" Length			
PART NO.	CTS	IPS	CTN QTY
C15050	1/2"	3/8"	24
C15075	3/4"	1/2"	12
C15100	1"	3/4"	12
C15125	1 1/4"	1"	12
C15150	1 1/2"	1 1/4"	12
C15151	-	1 1/2"	12
C15200	2"	-	12
C15201	-	2"	12

LEAD FREE			
PART NO.	CTS	IPS	CTN QTY
C15300	1/2"	3/8"	24
C15301	3/4"	1/2"	12
C15302	1"	3/4"	12
C15303	1 1/4"	1"	12
C15304	1 1/2"	1 1/4"	12
C15305	-	1 1/2"	12
C15306	2"	-	12
C15307	-	2"	12

PVC Compression Coupling



- For use on cold water lines only
- Ribbed body and nuts for gripping
- Fits IPS and Schedule 40 pipe
- EPDM gaskets
- 150 PSI at 73°F
- Pipe ends must be restrained

PART NO.	IPS	BODY LENGTH	CTN QTY
C12050	1/2"	3 3/4"	10
C12075	3/4"	3 15/16"	10
C12100	1"	4 3/4"	10
C12125	1 1/4"	5 3/16"	10
C12150	1 1/2"	5 3/8"	10
C12200	2"	6"	5
C12250	2 1/2"	7 7/8"	3
C12300	3"	8"	3
C12400	4"	12"	3
C12600	6"	11 1/8"	2

PVC Expansion Coupling



- Rated 200 PSI

PART NO.	IPS	BODY LENGTH	CTN QTY
E09050	1/2"	5 3/4"	28
E09075	3/4"	6 3/4"	24
E09100	1"	7 3/4"	15
E09125	1 1/4"	9"	10
E09150	1 1/2"	10"	16
E09200	2"	10 1/2"	12
E09250	2 1/2"	13"	3
E09300	3"	14 1/2"	3
E09400	4"	14 1/2"	3

CPVC Compression Coupling



- For use on hot water lines
- 100 PSI at temperatures up to 180°F
- Tubing sizes copper and plastic tubing
- EPDM gaskets
- Ribbed body and nuts for gripping
- Pipe ends must be restrained

PART NO.	TUBING SIZE	CTN QTY
C13050	1/2" (5/8" OD)	25
C13075	3/4" (7/8" OD)	25

Compression Tee

Malleable Iron



- Galvanized for corrosion protection
- Metal friction ring
- Compression tees must be restrained on both ends
- Fits both IPS and Schedule 40 pipe
- EPDM gaskets
- FIP branch
- 125 PSI at 120°F

PART NO.	SIZE	CTN QTY
C16050	1/2"	12
C16075	3/4"	12

Compression Tee

Bronze



- FIP branch
- EPDM gaskets
- Pipe ends must be restrained
- Bronze coated brass bodies and nuts
- Maximum 125 PSI at temperatures up to 180°F
- For use on galvanized pipe and copper tubing (check sizes)

PART NO.	CTS	IPS	BRANCH	CTN QTY
C19050	1/2"	3/8"	1/2" FIP	12
C19051	3/4"	1/2"	1/2" FIP	12
C19075	3/4"	1/2"	3/4" FIP	12

Compression Tee

PVC



- For use on cold water lines only
- Ribbed body and nuts for gripping
- Fits both IPS and Schedule 40 pipe
- EPDM gaskets
- 150 PSI at 73°F
- Threaded branch

PART NO.	SIZE	CTN QTY
C17050	1/2"	10
C17075	3/4"	10
C17100	1"	10
C17125	1 1/4"	5
C17150	1 1/2"	5
C17200	2"	5

Economy Test Plug



- Molded rubber gasket
- Galvanized steel flanges
- Fits cast iron and plastic pipe

PART NO.	PIPE SIZE	CTN QTY
T31001	1 1/2"	24
T31002	2"	24
T31003	3"	24
T31004	4"	24
T31006	6"	4
T31000	Replacement wing nut	10

Combination Test Plug



Raised Head



Countersunk

- Test up to three floors at once
- Combination test plug and cleanout
- Fits Schedule 40 DWV pipe
- Positive sealing
- No metal parts to rust

Raised Head		
PART NO.	PIPE SIZE	CTN QTY
T34001	1 1/2"	50
T34002	2"	50
T34003	3"	50
T34004	4"	50
T34006	6"	36
T34008	8"	20
Countersunk		
PART NO.	PIPE SIZE	CTN QTY
T34012	2"	50
T34013	3"	50
T34014	4"	50

T-Cone Cleanout Repair Plugs



- Easily repairs damaged or corroded metal or plastic cleanout threads

PART NO.	PIPE SIZE	THREAD ID	CTN QTY
T34150	1 1/2"	1.780	50
T34200	2"	2.255	50
T34300	3"	3.375	50
T34350	3 1/2"	3.900	50
T34400	4"	4.336	50

"Plum-Tite" Mechanical Test Plugs



- Neoprene gasket
- Extra large wingnut
- Rust and corrosion proof
- High density plastic construction

PART NO.	SIZE	CTN QTY
T37001	1 1/2"	10
T37002	2"	10
T37003	3"	10
T37004	4"	10
T37006	6"	5
T37008	8"	5

Cast Iron Test Plug



- Maximum 10 PSI
- To test cast iron soil pipe drainage systems
- Cold water ONLY

PART NO.	PIPE SIZE	CTN QTY
T39002	2"	6
T39003	3"	5
T39004	4"	4
T39006	6"	2
T39008	8"	1
T39010	10"	1
T39012	12"	1

Flexible PVC Test Cap



- Reinforced top
- 5/16" hex screw with screwdriver slot
- Fits both cast iron and plastic pipe

PART NO.	PIPE SIZE	CTN QTY
T32001	1 1/2"	24
T32002	2"	24
T32003	3"	24
T32004	4"	24
T32006	6"	12
T32008	8"	10
T32011	1 1/2"	200
T32022	2"	200
T32033	3"	200
T32044	4"	200

PVC Dual Fit Test Cap



- Each cap fits two sizes of Schedule 40 pipe
- CARTON QUANTITIES ONLY

PART NO.	PIPE SIZE	CTN QTY
T33152	1 1/2" and 2"	50
T33304	3" and 4"	25

Slip-On Plastic Cap



- DWV protection cap in various colors
- Protects from debris during construction

PART NO.	SIZE	CTN QTY
T36150	1 1/2"	300
T36200	2"	200
T36300	3"	75
T36400	4"	45
T36600	6"	25

Techno Test Plug Cap



- Heavy duty PVC, high pressure tested over six stories
- Easily solvent cemented over end of DWV pipe
- Will not clog or go down pipe
- CARTON QUANTITIES ONLY

PART NO.	DESCRIPTION	CTN QTY
T35001	1 1/2" DWV	100
T35002	2" DWV	100
T35003	3" DWV	50
T35004	4" DWV	25

PVC Test Cap



- Easily solvent cemented over end of DWV pipe
- CARTON QUANTITIES ONLY

PART NO.	DESCRIPTION	CTN QTY
T35201	1 1/2" PVC Test Cap	100
T35202	2" PVC Test Cap	100
T35203	3" PVC Test Cap	50
T35204	4" PVC Test Cap	25
T35206	6" PVC Test Cap	50

Knockout Test Cap



- For use in plastic waste and drain pipe
- Disposable
- CARTON QUANTITIES ONLY

PART NO.	PIPE SIZE	CTN QTY
T33001	1 1/2"	100
T33002	2"	100
T33003	3"	50
T33004	4"	50

Pneumatic Test Plug



Regular

Long

- Manufactured in the USA
- All units smaller than 8" are supplied with chain and ring
- All units 8" or larger are supplied with a removable eye bolt
- For use with cast iron, PVC, ABS, copper, clay and concrete pipe

MADE IN THE
USA

Regular					
PART NO.	NOM. PIPE SIZE	MAX AIR PRESSURE	MAX TEST PRESSURE	MAX HEAD	CTN QTY
T45150	1 1/4"-1 1/2"	40 PSI	5 PSI	30'	6
T45200	2"	40 PSI	5 PSI	30'	6
T45300	3"	35 PSI	5 PSI	30'	6
T45400	4"	30 PSI	5 PSI	30'	6
T45600	6"	25 PSI	5 PSI	30'	1
T45800	8"	25 PSI	15 PSI	40'	1
T45010	10"	25 PSI	15 PSI	40'	1
T45012	12"	25 PSI	15 PSI	40'	1

Long					
PART NO.	NOM. PIPE SIZE	MAX AIR PRESSURE	MAX TEST PRESSURE	MAX HEAD	CTN QTY
T46200	2"	45 PSI	5 PSI	30'	1
T46300	3"	35 PSI	5 PSI	30'	1
T46400	4"	30 PSI	5 PSI	30'	1

Pneumatic-Hydraulic Test Plug



- Uses either water or air
- Temperature range 30° - 200°F
- User safe; cannot be overinflated
- Individually tested for 24 hours to insure proper operation
- Using water, stack can be filled and plugged from same position

MADE IN THE
USA

PART NO.	PIPE SIZE	MFG PART NO.	CTN QTY
T30002	1 1/4"-2"	WATP 2	4
T30034	3"-4"	WATP 3-4	4
T30046	4"-6"	WATP 4-6	4
T30068	5"-8"	WATP 6-8	1
T30102	10"-12"	WATP 10-12	1

Two Stage Long Test Plug



- Two stage deflation allows access pipe to remain sealed while water clears drain line

PART NO.	PIPE SIZE	MFG PART NO.	CTN QTY
T30203	2"-3"	DDO203	1
T30304	3"-4"	DDO304	1

Inflatable Tee Plug



Inflated Test Plug

- Threads directly into test tee
- Threads into both CI and plastic pipe
- Body is high quality natural rubber
- Top is made from high impact ABS plastic

PART NO.	DESCRIPTION	CTN QTY
T33200	2" Inflatable Tee Plug	1
T33300	3" Inflatable Tee Plug	1
T33400	4" Inflatable Tee Plug	1

Drain King®



D18501



D18186



D18034



D18750



D18560



D18340

- Insert in drain line opening
- Turn water on
- Automatically seals drain and powerful water pulses loosen and clear drain

PART NO.	PIPE SIZE	DK NO.	CTN QTY
D18501	1"-2"	D501	12
D18186	1 1/2"-3"	D186	12
D18034	3"-4"	H34	12
D18750	3"-6"	D750	6
D18850	6"-10"	D850	1
D18560	1"-2" with drain adapter	H560	6
D18340	1 1/2"-3" with 10" hose and faucet adapter	PE60	12
D18060	Drain Adapter	PE60	12

Plumbjet



D18400



D18401



D18402

- Attaches to garden hose
- All natural
- Environmentally safe

PART NO.	PIPE SIZE	DK NO.	CTN QTY
D18400	1"-2"	D501	12
D18401	1 1/2"-3"	D186	12
D18402	4"-6"	H34	6

Extension Hose



- For pneumatic test plug
- Can be used in tandem

PART NO.	SIZE	CTN QTY
T45002	2'	1
T45003	3'	1

Force Cup Plunger



Red Rubber



Black Rubber

- Supplied with handle
- Highest quality rubber plungers

PART NO.	DESCRIPTION	CTN QTY
D18001	5 1/2" diameter (red rubber)	12
D18002	6" professional style (black rubber)	12

Professional Force Cup Display



Cloghopper Display

- Supplied with handle
- Highest quality rubber plungers
- Attractive point of purchase display
- Display box contains 30 rubber plungers
- CARTON QUANTITIES ONLY

PART NO.	DESCRIPTION	CTN QTY
D18000	Rubber plungers and display box	30

Flexible PVC Saddle Fitting



Tee Pattern



Wye Pattern

- Provided with stainless steel clamp on inlet
- Includes stainless steel clamps on saddle to fit up to 12" clay pipe
- Extension clamps may be used for larger pipe sizes

Tee Pattern

PART NO.	DESCRIPTION	CTN QTY
S26001	4" plastic-12" clay saddle x 4" Sch.40 CI or SDR35 inlet	3
S26002	4" plastic - 6" clay saddle x 4" Sch.40 CI or SDR35 inlet	1
S26003	4" saddle blanket	6

Wye Pattern

PART NO.	DESCRIPTION	CTN QTY
S27001	4" plastic - 12" clay saddle x 4" Sch. 40 cast iron or SDR35 inlet	1
S27002	4" plastic - 6" clay saddle x 4" Sch. 40 cast iron or SDR35 inlet	1

Replacement Clamp

PART NO.	DESCRIPTION	CTN QTY
S26100	4"-12" gear clamp	1

Flexible Trap Drain Connector



PART NO.	DESCRIPTION	CTN QTY
T06001	Connects 1 1/4"-1 1/2" tubular to 1 1/4"-1 1/2" tubular	20
T06002	Connects 1" DWV or 1/2" CTS to 1 1/4"-1 1/2" tubular	20
T06003	Connects 1 1/2" DWV or CTS to 1 1/4"-1 1/2" tubular	20
T06004	Connects 2" DWV to 1 1/4"-1 1/2" tubular	20

Flexible Transition Coupling



T06320



T06400

- EPDM rubber
- UPC listed
- For use on PVC, DWV and CI pipe
- Stainless steel clamps and housing

PART NO.	DESCRIPTION	CTN QTY
T06025	1 1/4" PL + CI to PL + CI	350
T06050	1 1/2" PL + CI to PL + CI	150
T06200	2" PL + CI to PL + CI	105
T06250	2" x 1 1/2" PL + CI to PL + CI	105
T06300	3" PL + CI to PL + CI	60
T06320	3" x 2" PL + CI to PL + CI	80
T06400	4" PL + CI to PL + CI	36
T06430	4" x 3" PL + CI to PL + CI	44
T06600	6" PL + CI to PL + CI	12
T06640	6" x 4" PL + CI to PL + CI	15
T06800	8" PL + CI to PL + CI	6

Bore O-Ring



PART NO.	DESCRIPTION	CTN QTY
B12640	6" bore x 4" plastic or cast iron	20

Qwik Tee



PART NO.	DESCRIPTION	CTN QTY
T07150	1 1/2" x 1 1/2" x 1 1/2" tee	10
T07200	2" x 2" x 2" tee	10
T07300	3" x 3" x 3" tee	10
T07400	4" x 4" x 4" tee	10

Qwik Elbow



PART NO.	DESCRIPTION	CTN QTY
E10150	1 1/2" x 1 1/2" elbow	10
E10200	2" x 2" elbow	10
E10300	3" x 3" elbow	10
E10400	4" x 4" elbow	10

Bushing for Qwik Tees and Qwik Elbows



PART NO.	DESCRIPTION	CTN QTY
B12210	2" x 1 1/2" bushing	10
B12320	3" x 2" bushing	10
B12430	4" x 3" bushing	10

Hose Grip Clothes Washer Connector



- Fits 1 1/2" or 2" standpipe
- Fits 1" - 1 7/16" drain hose
- Securely holds drain hose in standpipe

PART NO.	DESCRIPTION	CTN QTY
D08001	Drain hose connector	20

Flexible Drain Trap



PART NO.	DESCRIPTION	CTN QTY
J01001	1 1/4" or 1 1/2" tubular trap j-bend	10

Washing Machine Boxes with Valves



- Long shank MIP valve
- White box with valve installed
- Combo 1 1/2" or 2" drain
- CARTON QUANTITIES ONLY

PART NO.	DESCRIPTION	CTN QTY
B05900	Offset drain	10
B05901	Center drain	10

Washing Machine Boxes with Hammer Arrester



- 1/4 Turn valves or lever handle mixer valve

Dual Drain		
PART NO.	DESCRIPTION	CTN QTY
B05920	1/4 Turn valve with Solder connection	1
B05921	1/4 Turn valve with CPVC connection	1
B05922	Single lever handle with Solder connection	1

Center Drain		
PART NO.	DESCRIPTION	CTN QTY
B05923	1/4 Turn valve with Solder connection	1
B05924	1/4 Turn valve with CPVC connection	1

Replacement Frame		
PART NO.	DESCRIPTION	CTN QTY
B05927	Replacement Frame for Washer Box	1
B05928	Replacement Frame for Icemaker Box	1

Icemaker Boxes with Hammer Arrester



- 1/4 Turn valve

PART NO.	DESCRIPTION	CTN QTY
B05925	Icemaker box with Solder connection	1
B05926	Icemaker box with CPVC connection	1

Icemaker Boxes with Valves



- White box with valve installed
- CARTON QUANTITIES ONLY

PART NO.	DESCRIPTION	CTN QTY
B05910	Icemaker box with brass valve	10
B05911	Icemaker box with Flowguard all CPVC icemaker valve	10

Dishwasher Hose

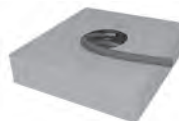

- IAPMO/UPC listed; meets ANSI, AHAM-DWI specifications
- 5/8" connects dishwasher pump to airgap inlet or dishwasher tailpiece
- 7/8" connects airgap outlet to branch tailpiece or disposal
- EPDM material with single spiral reinforcement
- Resists kinking
- Marked per foot
- -40°F to +180°F

PART NO.	SIZE	WP	BURST PRESSURE	CTN QTY
D10625	5/8" ID x 50'	90	200	1
D10875	7/8" ID x 50'	70	100	1

Dishwasher Drain Connector



- CARTON QUANTITIES ONLY
- Includes two worm gear clamps

PART NO.	DESCRIPTION	CTN QTY
D10001	Universal connector	50

Washing Machine Hose



Straight Female



With 90° Elbow

- For hot or cold use
- Bagged with washers
- Standard female hose threads
- Bursting pressure 800 lbs. per sq. inch
- 3/8" ID

With 90° Elbow		
PART NO.	LENGTH	CTN QTY
J04104	4'	1
J04105	5'	1
J04106	6'	1

Straight Female		
PART NO.	LENGTH	CTN QTY
J04004	4'	12
J04005	5'	12
J04006	6'	12

Washing Machine Hose



- Industrial quality
- 1/2" ID EPDM rubber for hot and cold use
- Polyester yarn reinforcement
- 3/4" female hose ends
- Temp. rating -40°F to +190°F
- Stamped brass ends and crimps
- 200 PSI working pressure
- Bagged with washers

PART NO.	LENGTH	CTN QTY
J04204	4'	12
J04205	5'	12
J04206	6'	12

Mixer Hose



- High pressure hose; 12" arms
- Individually bagged

PART NO.	DESCRIPTION	CTN QTY
J04012	Mixer	12

Fit-All Drain Hose for Washing Machine



- Individually bagged
- 3 size step down 3/4", 7/8" and 1" for drain lines

PART NO.	SIZE	CTN QTY
J04016	5'	12

Washing Machine Drain Hose

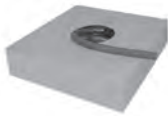

PART NO.	SIZE	CTN QTY
D10900	1" x 50' roll	1

Washing Machine Pan



- 2 1/2" deep heavy gauge plastic pan
- CARTON QUANTITIES ONLY

PART NO.	DESCRIPTION	CTN QTY
J04250	29" x 31" with side mount drain	5

Washer/Dryer Combo Pan



- Fits most laundry areas
- High-impact copolymer material; less expensive than marble or tile
- Lightweight
- White acrylic surface - will not crack, chip, stain or mildew
- 2" PVC drain included
- Keeps washer and dryer level

PAN DIMENSIONS			
	LENGTH	WIDTH	DEPTH
OD	60 1/2"	32 3/8"	1 1/2"
ID	56"	28"	1 1/4"

PART NO.	DESCRIPTION	CTN QTY
J04251	Washer/dryer combo pan	1

Dryer Vent Hood



- PVC hood
- Weather proof 12" aluminum extension
- Pre-punched mounting holes
- CARTON QUANTITIES ONLY

PART NO.	SIZE	CTN QTY
D04012	4"	6

Aluminum Vent Hood



- For clothes dryers or exhaust fans
- Complete with damper and flange plate

PART NO.	SIZE	CTN QTY
D04023	3"	1
D04024	4"	1

Louvered Dryer Vent Hood



- Includes hood, aluminum pipe and collar

PART NO.	DESCRIPTION	CTN QTY
D04025	4" white hood assembly	6
D04026	4" brown hood assembly	6

White Back Collar for Dryer Vent Kits



PART NO.	DESCRIPTION	CTN QTY
D04064	White back collar	6

Complete Dryer Vent Kit



- Kit includes hose (5' or 8'), vent and 2 plastic clamps
- Hood is waterproof plastic
- 5 3/4" square back plate
- 12" aluminum extension, pre-punched mounting holes

PART NO.	DESCRIPTION	CTN QTY
D04005	4" x 5'	12
D04008	4" x 8'	12
D04009	4" x 8' flex aluminum duct with louvered hood and two metal clamps	6

Clamp for Dryer Vent Kit



PART NO.	DESCRIPTION	CTN QTY
D04010	4" clamp only	10

Metal Clamp for Dryer Vent



- Heavy duty all metal design
- Excellent for use with metal ducting

PART NO.	SIZE	CTN QTY
D04015	3"	1
D04016	4"	1
D04017	5"	1
D04018	6"	1

Aluminum Elbow and Pipe



- All aluminum

PART NO.	DESCRIPTION	CTN QTY
D04013	3" x 90° swivel elbow	50
D04014	3" x 24" aluminum pipe	40
D04027	4" x 90° swivel elbow	50
D04028	4" x 24" aluminum pipe	40

Flexible Duct Connector Kit



- Connects flexible ducting
- Extends exhaust collar of clothes dryer

PART NO.	SIZE	CTN QTY
D04019	4"	1

Increaser/Decreaser



- Connects 3" to 4" ducting or 4" ducting to 3" exhaust collar

PART NO.	DESCRIPTION	CTN QTY
D04021	3"-4" plastic increaser/decreaser	1
D04022	4"-3" aluminum reducer	1
D04055	3"-4" aluminum increaser	1

Flexible Aluminum Ducting



- Ideal for exhausting clothes dryers
- Bendable to any configuration
- No fire or UL ratings

PART NO.	SIZE	CTN QTY
D04031	3" x 8'	10
D04032	4" x 8'	10
D04033	5" x 8'	6
D04034	6" x 8'	4
D04053	3" x 25'	20
D04054	4" x 25'	4

Proflex Aluminum Foil Ducting



- Flexible, fire resistant
- Will not support combustion
- Wire reinforced
- UL listed

PART NO.	SIZE	CTN QTY
D04058	4" x 5'	12
D04059	4" x 8'	12
D04060	4" x 50'	1

Flexible Aluminum Foil Ducting



- Ideal for exhausting clothes dryers and bathroom fans
- Will not support combustion
- No fire or UL ratings

PART NO.	SIZE	CTN QTY
D04056	4" x 25'	1
D04057	4" x 8'	1

Dryer Vent Hose



- Wire-reinforced vinyl

PART NO.	DESCRIPTION	CTN QTY
D04020	4" x 20' (boxed)	10
D04051	4" x 5' (bagged)	16

Dryer Vent Kit w/Louvered Hood



- Includes vinyl hose, aluminum pipe, collar, clamps and louvered hood

PART NO.	DESCRIPTION	CTN QTY
D04001	4" x 5' with white hood	12
D04002	4" x 5' with brown hood	12
D04003	4" x 8' with white hood	12
D04004	4" x 8' with brown hood	12

Bathroom Fan Vent Kit



- Contains the following part for 3" and 4" wall type exhaust fans: 4" x 5' flexible vinyl ducting, clamps, 4" louvered vent, 3"-4" foam increaser

PART NO.	DESCRIPTION	CTN QTY
D04035	Bathroom fan vent kit	1
D04050	4" x 50' (boxed)-vinyl hose only	1
D04062	3" x 50' (boxed)-vinyl hose only	1

Indoor Dryer Vent Kit



- Use on electric clothes dryers when outside venting is not possible
- Recirculates warm, moist air
- Specially designed lint reservoir

PART NO.	DESCRIPTION	CTN QTY
D04036	Indoor dryer vent kit	1

Domestic Pipe Wrap Tape



• CARTON QUANTITIES ONLY

Yellow

PART NO.	SIZE	THICKNESS	CTN QTY
T16002	2" x 100'	12 mil.	24
T16004	4" x 100'	12 mil.	12

Black

PART NO.	SIZE	THICKNESS	CTN QTY
T17002	2" x 100'	12 mil.	24
T17004	4" x 100'	12 mil.	12

Imported Pipe Wrap Tape



• UPC listed black tape with PVC backing
• CARTON QUANTITIES ONLY

PART NO.	SIZE	THICKNESS	CTN QTY
T17101	1" x 100'	10 mil.	48
T17102	2" x 100'	10 mil.	24
T17104	4" x 100'	10 mil.	18
T18201	1" x 100'	20 mil.	48
T18202	2" x 100'	20 mil.	24

Primer for Pipe Wrap Tape



• Maximizes tape performance
• Final step in preparing steel surfaces for taping
• Can more than double adhesion of corrosion tapes to cleaned steel
• CARTON QUANTITIES ONLY
• MOTOR FREIGHT ONLY / FLAMMABLE

PART NO.	SIZE	CTN QTY
T16100	Quart	12

Electrical Tape



• UL listed
• Individually wrapped
• Black vinyl
• CARTON QUANTITIES ONLY

PART NO.	SIZE	CTN QTY
T20030	3/4" x 60'	10

Slic-tite® High Density Thread Sealants



• Thickness 4 mils
• Provides a highly resistant seal on pipe threads for all types of service
• Non-toxic
• Permits easy disassembly, even after years of service
• Meets Mil. Spec T-27730A
• Sealing temperature: -450°F to 550°F (-268°C to 288°C)
• Pressures: to 2,000 PSI (136 BAR)



PART NO.	SIZE	CTN QTY
T19118	1/2" x 600"	12
T19119	3/4" x 600"	12
T19120	1" x 600"	12
T19121	1/4" x 300"	12
T19123	1/4" x 600"	12
T19124	1/2" x 300"	12
T19126	1/2" x 1200"	12
T19127	3/4" x 300"	12
T19128	1" x 300"	12

PTFE Thread Seal Tape



• Temperature range is 500°F to +650°F
• Withstands pressure up to 5000 PSI
• Meets U.S. government military specification MIL-T27730A
• Thickness 3 mil. plus

PART NO.	SIZE	CTN QTY
T19122	1/2" x 260"	200
T19125	1/2" x 520"	200
T19342	3/4" x 260"	150
T19345	3/4" x 520"	150

Thread Seal Tape Jar Display



• Meets U.S. MILSPEC T27730A
• Withstands pressure up to 5000 PSI
• Temperatures to +650°F
• Thickness 3 mil. plus

PART NO.	DESCRIPTION	CTN QTY
CJ1002	1/2" x 260" Teflon Tape	25

PTFE Yellow Gas Line Thread Seal Tape



• Temperature range is -450°F to +500°F
• Withstands pressure up to 5000 PSI
• Meets U.S. government military specification MIL-T27730A
• 0035 mil
• UL listed

PART NO.	SIZE	CTN QTY
T19222	1/2" x 260"	144

Duct Tape



• Premium grade, waterproof non-elastic reinforced cloth
• Pressure sensitive; vapor and flame resistant
• CARTON QUANTITIES ONLY

PART NO.	SIZE	THICKNESS	CTN QTY
T20020	2" x 60 yds (gray)	8.5 mil.	24
T20023	2" x 60 yds (black)	10 mil.	24

Box Sealing Tape



PART NO.	DESCRIPTION	CTN QTY
T20040	2" x 55 yds	36
T20041	2" x 110 yds	36
T20050	Dispenser	1

Self-Fusing Tape



TOMMY TAPE®



• Silicone all purpose repair tape
• Water-tight seal for automotive, electrical, marine, plumbing and general-purpose applications
• Carded

PART NO.	DESCRIPTION	CTN QTY
T20200	20 mil x 1 x 16 self-fusing tape	6

Stretch Wrap

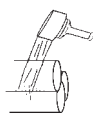

- Use instead of tape to bind packages or parts
- Protects products from dirt and moisture
- Can be used on palletted shipments or small orders
- Great for wrapping lengths of pipe
- CARTON QUANTITIES ONLY

PART NO.	SIZE	GAUGE	ROLLS/CTN
S51120	3" x 700'	120	18
S51080	3" x 1000'	80	18

Stretch Wrap Film and Dispenser



- Secures packages to pallets
- Reduces lost packages
- Retards moisture
- Lowers handling costs
- Wrapping is priced per carton - no broken cartons

PART NO.	DESCRIPTION	CTN QTY
S51001	80 gauge wrap 18" x 1500'	4 rolls
S51002	Hand dispenser	1

Pipe Sleeving



- Underground sleeving protects against lime reaction in concrete
- Allows expansion and contraction of pipe, minimizing stress
- Individually boxed; color-coded (red for hot, blue for cold)
- UPC approved and IAPMO listed

PART NO.	PIPE SIZE	THICKNESS	COLOR	LENGTH	CTN QTY
S22001	1/2"-1"	6 mil	Red	200'	1
S22002	1/2"-1"	6 mil	Blue	200'	1
S22003	1/2"-1"	10 mil	Red	100'	1
S22004	1/2"-1"	10 mil	Blue	100'	1
S22005	1/2"-1"	25 mil	Red	100'	1
S22006	1/2"-1"	25 mil	Blue	100'	1

Water Resistant Sand Cloth



- Dispenser box
- Water resistant aluminum oxide
- 120 grit abrasive cloth for cleaning pipe and fittings

PART NO.	SIZE	CTN QTY
C25000	1 1/2" x 2 yds	50
C25001	1 1/2" x 5 yds	50
C25002	1 1/2" x 10 yds	50
C25003	1 1/2" x 25 yds	25

Open Mesh



- Dispenser box
- 100% waterproof
- Polyester on both sides
- 180 grit with large holes for aggressive sanding
- Can be exposed to water and solvents indefinitely without breakdown

PART NO.	SIZE	CTN QTY
C25010	1 1/2" x 5 yds	50
C25011	1 1/2" x 10 yds	50

Flexible Open Mesh



- Dispenser box
- 100% waterproof
- Polyester on both sides
- 180 grit
- Smaller holes for finer sanding

PART NO.	SIZE	CTN QTY
C25012	1 1/2" x 5 yds	50
C25013	1 1/2" x 10 yds	50

Waterproof Aluminum Oxide



- Dispenser box
- 100% waterproof
- Wet cut
- 120 grit

PART NO.	SIZE	CTN QTY
C25020	1 1/2" x 5 yds	50
C25021	1 1/2" x 10 yds	50
C25022	1 1/2" x 25 yds	25

SEAMLESS RUBBER

Pipe Insulation

Flexible Closed Cell Insulation



DESCRIPTION

Seamless Rubber Pipe Insulation is an environmentally friendly, CFC-free, flexible elastomeric thermal insulation.

APPLICATIONS

Seamless Rubber Pipe Insulation is used to retard heat gain and prevent condensation or frost formation on refrigerant lines, cold water plumbing, and chilled water systems. It also retards heat flow for hot water plumbing, liquid heating, dual temperature piping, and many solar systems.

Seamless Rubber is recommended for applications ranging from -70°F to 220° F (-57° C to 104° C). The expanded closed cell structure makes Seamless Rubber an efficient insulator and an effective moisture vapor retarder.

Due to its unique microwave curing process, Seamless Rubber has a very tough skin which withstands tearing, rough handling, and severe environmental conditions, and yet is quite flexible for easy installation.

Seamless Rubber has superior cold weather flexibility.

INSTALLATION

With a factory-applied coating of talc on the smooth inner surface, Seamless Rubber slides easily over pipe or tubing for quick installation. When applied to existing lines, tubing is slit lengthwise and snapped into place. (Slitting can be done on the job with a sharp knife. All seams and butt joints should be sealed with Seamless Rubber Contact Adhesive, making sure both surfaces to be joined are coated with adhesive.

OUTDOOR APPLICATIONS

Outdoor applications require UV Protective Coating. For best appearance, two coats are recommended.

UNDERGROUND

For buried lines above the water table, use a clean fill such as sand (3"-5" layer) to protect Seamless Rubber before backfilling. It is recommended that materials to be buried are properly sealed at all seams and butt joints with Contact Adhesive. For optimum performance, the lines should be encased in a conduit to protect them from problems associated with ground water.

RESISTANCE TO MOISTURE VAPOR FLOW

The closed-cell structure of Seamless Rubber effectively retards the flow of moisture vapor, and is considered a low transmittance vapor retarder. For most applications, Seamless Rubber needs no additional protection. Additional vapor barrier protection may be necessary for Seamless Rubber when

installed on low temperature surfaces or where it is exposed to continuous high humidity.

FLAME AND SMOKE RATING

Seamless Rubber Pipe Insulation in wall thicknesses of 1" (25 mm) and below has a flame spread rating of 25 or less and a smoke development rating of 50 or less as tested by ASTM E 84 Method of Testing entitled: "Surface Burning Characteristics of Building Materials."

Numerical flammability ratings alone may not define the performance of products under actual fire conditions. They are provided only for us in the selection of products to meet limits specified, when compared to a known standard.

SPECIFICATION COMPLIANCE

ASTM C 534 Type 1 (Tubing)
ASTM D 1056-91-2C1
MEA 186-86-M Vol. IV (New York City)
USDA Requirements

UL 94-5V Flammability Classification (Recognition No. E55475)
Complies with requirements of CAN/ULC S102-M88
ASTM E 84 1" 25/50-tested according to UL 723 and NFPA 255

Meets requirements of NFPA 90A Sect. 2.3.3 for Supplementary Materials for Air Distribution Systems

NFPA No. 101 Class A Rating
Meets requirements of UL 181 sections 11.0 and 16.0

MIL-P-15280, For T (Tubing)

PHYSICAL PROPERTIES		SEAMLESS RUBBER INSULATION	TEST METHODS
Thermal Conductivity (K) BTU -in/hr-Ft2 - °F (W/mK)	90° F (32° C) Mean Temp 75° F (24° C) Mean Temp 50° F (10° C) Mean Temp	.282 (.041) .277 (.040) .270 (.039)	ASTM C 177 ASTM C 177 ASTM C 177
Operating Temperature Range	Upper	200° F (104° C)	
Flexible to -100° F (-73° C)	Lower	-70° F (-57° C)	
Water Vapor Permeability Dry Cup. Perm-In		.10	ASTM E 96
Water Absorption % weight gain		5%	ASTM D 1056
Ozone Resistant		Pass	ASTM D 1171
Chemical/Solvent Resistance		Good	
Mildew Resistance/Air Erosion		Pass	UL 181

THICKNESS RECOMMENDATIONS* - TO CONTROL CONDENSATION								
PIPE SIZE	LINE TEMP		LINE TEMP		LINE TEMP		LINE TEMP	
	50° F	10° C	35° F	2° C	0° F	-18° C	-20° F	-29° C
Normal Conditions (Max 85°F, 29°C - 70% R.H.)								
3/8" ID thru 1 3/8" ID	3/8"	10 mm	1/2"	13 mm	3/4"	19 mm	1"	25 mm
Over 1 3/8" thru 3" IPS	3/8"	10 mm	1/2"	13 mm	1"	25 mm	1"	25 mm
Over 3" IPS thru 4" IPS**	1/2"	13 mm	1/2"	13 mm	1"	25 mm	1 1/4"	32 mm
Over 4" IPS	1/2"	13 mm	3/4"	19 mm	1"	25 mm	1 1/4"	32 mm
Mild Conditions (Max 80°F, 26°C - 50% R.H.)								
3/8" ID thru 2 1/8" ID	3/8"	10 mm	3/8"	10 mm	1/2"	13 mm	1/2"	13 mm
Over 2 1/8" thru 3" IPS	3/8"	10 mm	3/8"	10 mm	1/2"	13 mm	3/4"	19 mm
Over 3" IPS thru 4" IPS**	1/2"	13 mm	1/2"	13 mm	3/4"	19 mm	3/4"	19 mm
Over 4" IPS	1/2"	13 mm	1/2"	13 mm	3/4"	19 mm	3/4"	19 mm
Severe Conditions (Max 90°F, 32°C - 80% R.H.)								
3/8" ID thru 1 1/8" ID	3/4"	19 mm	3/4"	19 mm	1 1/4"	32 mm	1 1/4"	32 mm
Over 1 1/8" ID thru 4" IPS	3/4"	19 mm	1"	25 mm	1 1/2"	38 mm	1 1/2"	38 mm
Over 4" IPS	3/4"	19 mm	1 1/4"	32 mm	1 3/4"	44 mm	2"	50 mm

Seamless Rubber in thickness notes within the specified temperature ranges will prevent condensation on indoor piping under design conditions defined below. Thickness recommendations above 1" can be sleeved to achieve thickness desired.

Normal: Maximum severity of indoor conditions seldom exceed 85° F (29° C) and 70% R.H. in United States.

Mild: Typical conditions are most air-conditioned spaces and arid climates.

Severe: Generally found in areas which excessive moisture is introduced or in poorly ventilated areas where the temperature may be depressed below the ambient. Under conditions of high humidity, additional thickness of insulation may be required.

**Available: Nom. 1/2" or Nom. 3/4" thickness only

SEAMLESS RUBBER "R" VALUES PER SQUARE FOOT					
Pipe OD or Nominal Insulation ID		R Value 3/8" (10 mm) Wall	R Value 1/2" (13 mm) Wall	R Value 3/4" (19 mm) Wall	R Value 1" (25 mm) Wall
3/8"	10 mm	2.3	3.1	4.7	-
1/2"	13 mm	2.2	2.9	4.7	7.6
5/8"	16 mm	2.1	2.7	4.6	7.1
3/4"	19 mm	2.0	2.6	4.6	6.7
7/8"	22 mm	1.9	2.7	4.6	6.5
1 1/8"	29 mm	1.8	2.6	4.6	5.1
1 3/8"	35 mm	1.8	2.7	4.4	5.8
1 1/2" IPS	-	2.0	2.6	4.3	5.5
1 5/8"	41 mm	2.1	2.7	4.3	5.5
2 1/8"	54 mm	1.9	2.6	4.0	5.2
2" IPS	-	2.0	2.7	4.1	5.2
2 1/2" IPS	64 mm	1.9	2.6	3.9	5.0
2 5/8"	67 mm	2.0	2.7	4.0	5.1
3 1/8"	79 mm	1.9	2.5	3.8	4.9
3" IPS	-	2.0	2.8	3.9	5.0
3 5/8"	92 mm	-	2.6	3.7	-
4 1/8"	105 mm	-	2.6	3.7	-
4" IPS	-	-	2.8	3.9	-
5" IPS	-	1.9	2.6	3.9	-
6" IPS	-	-	2.4	3.6	-
8" IPS	-	-	2.4	3.6	-

Note: "R" factors were calculated from using the K factor of .277 (75°F, 24°C mean temp) and nominal wall thickness is each case. Lower operating temperatures will result in improved R values.

Seamless Rubber Pipe Insulation



- Environmentally friendly
- 4 Wall thicknesses: 3/8", 1/2", 3/4" and 1"
- Sizes range from 3/8" ID to 4" IPS
- Sizes not listed are special order. Allow two weeks for delivery.
- CFC-free
- Color - Black with blue ink
- Easy installation, flexible
- CARTON QUANTITIES ONLY

3/8" Wall Thickness

PART NO.	COPPER OD	IPS/PVC	FT/BOX
I60025	1/4"	-	720'
I60038	3/8"	-	612'
I60050	1/2"	1/4"	432'
I60058	5/8"	3/8"	378'
I60075	3/4"	-	342'
I60078	7/8"	1/2"	288'
I60118	1 1/8"	-	216'
I60138	1 3/8"	-	168'
I60158	1 5/8"	1 1/4"	150'
I60200	-	1 1/2"	120'
I60218	2 1/8"	-	96'
I60250	-	2"	84'
I60258	2 5/8"	-	72'
I60300	-	2 1/2"	60'
I60318	3 1/8"	-	60'
I60350	-	3"	48'

1/2" Wall Thickness

PART NO.	COPPER OD	IPS/PVC	FT/BOX
I61038	3/8"	-	456'
I61050	1/2"	1/4"	360'
I61058	5/8"	3/8"	324'
I61075	3/4"	-	270'
I61078	7/8"	1/2"	228'
I61118	1 1/8"	-	156'
I61138	1 3/8"	-	120'
I61158	1 5/8"	1 1/4"	114'
I61200	-	1 1/2"	114'
I61218	2 1/8"	-	102'
I61250	-	2"	66'
I61258	2 5/8"	-	60'
I61300	-	2 1/2"	48'
I61318	3 1/8"	-	48'
I61350	-	3"	36'
I61358	3 5/8"	-	36'
I61418	4 1/8"	-	24'
I61450	-	4"	24'

Seamless Rubber Pipe Insulation



- Environmentally friendly
- 4 Wall thicknesses: 3/8", 1/2", 3/4" and 1"
- Sizes range from 3/8" ID to 4" IPS
- Sizes not listed are special order. Allow two weeks for delivery.
- CFC-free
- Color - Black with blue ink
- Easy installation, flexible
- CARTON QUANTITIES ONLY

3/4" Wall Thickness

PART NO.	COPPER OD	IPS/PVC	FT/BOX
I62038	3/8"	-	294'
I62050	1/2"	1/4"	228'
I62058	5/8"	3/8"	180'
I62075	3/4"	-	144'
I62078	7/8"	1/2"	126'
I62118	1 1/8"	-	90'
I62138	1 3/8"	-	78'
I62158	1 5/8"	1 1/4"	72'
I62200	-	1 1/2"	66'
I62218	2 1/8"	-	60'
I62250	-	2"	48'
I62258	2 5/8"	-	42'
I62300	-	2 1/2"	36'
I62318	3 1/8"	-	36'
I62350	-	3"	30'
I62358	3 5/8"	-	30'
I62418	4 1/8"	-	24'
I62450	-	4"	24'

1" Wall Thickness

PART NO.	COPPER OD	IPS/PVC	FT/BOX
I63058	5/8"	3/8"	108'
I63075	3/4"	-	108'
I63078	7/8"	1/2"	90'
I63118	1 1/8"	-	66'
I63138	1 3/8"	-	60'
I63158	1 5/8"	1 1/2"	54'
I63200	-	1 1/2"	42'
I63218	2 1/8"	-	42'
I63250	-	2"	36'
I63258	2 5/8"	-	36'
I63300	-	2 1/2"	36'
I63318	3 1/8"	-	30'
I63350	-	3"	30'
I63358	3 5/8"	-	30'

Double Stick Rubber Pipe Insulation



- Environmentally friendly
- 4 Wall thicknesses: 3/8", 1/2", 3/4" and 1"
- Sizes range from 3/8" ID to 4" IPS
- Split with adhesive on both sides
- CFC-free
- Color - Black with blue ink
- Easy installation, flexible
- CARTON QUANTITIES ONLY

3/8" Wall Thickness

PART NO.	COPPER OD/IPS	FT/BOX
I80038	3/8"	570'
I80050	1/2"	402'
I80058	5/8"	348'
I80034	3/4"	318'
I80078	7/8"	288'
I80118	1 1/8"	216'
I80138	1 3/8"	150'
I80150	1 1/2" IPS	120'
I80158	1 5/8"	132'
I80200	2" IPS	78'
I80218	2 1/8"	78'
I80250	2 1/2" IPS	60'
I80258	2 5/8"	72'
I80318	3 1/8"	60'

1/2" Wall Thickness

PART NO.	COPPER OD/IPS	FT/BOX
I81038	3/8"	420'
I81050	1/2"	312'
I81058	5/8"	312'
I81034	3/4"	270'
I81078	7/8"	216'
I81118	1 1/8"	150'
I81138	1 3/8"	120'
I81150	1 1/2" IPS	108'
I81158	1 5/8"	108'
I81200	2" IPS	60'
I81218	2 1/8"	60'
I81250	2 1/2" IPS	48'
I81258	2 5/8"	60'
I81300	3" IPS	36'
I81318	3 1/8"	48'
I81358	3 5/8"	36'
I81400	4" IPS	24'
I81418	4 1/8"	24'

Double Stick Rubber Pipe Insulation



- Environmentally friendly
- 4 Wall thicknesses: 3/8", 1/2", 3/4" and 1"
- Sizes range from 3/8" ID to 4" IPS
- Split with adhesive on both sides
- CFC-free
- Color - Black with blue ink
- Easy installation, flexible
- CARTON QUANTITIES ONLY

3/4" Wall Thickness

PART NO.	COPPER OD/IPS	FT/BOX
I82038	3/8"	258'
I82050	1/2"	192'
I82058	5/8"	180'
I82034	3/4"	120'
I82078	7/8"	126'
I82118	1 1/8"	90'
I82138	1 3/8"	78'
I82150	1 1/2" IPS	66'
I82158	1 5/8"	72'
I82200	2" IPS	48'
I82218	2 1/8"	60'
I82250	2 1/2" IPS	36'
I82258	2 5/8"	42'
I82300	3" IPS	30'
I82318	3 1/8"	36'
I82358	3 5/8"	30'
I82400	4" IPS	24'
I82418	4 1/8"	24'

1" Wall Thickness

PART NO.	COPPER OD/IPS	FT/BOX
I83058	5/8"	108'
I83034	3/4"	78'
I83078	7/8"	78'
I83118	1 1/8"	66'
I83138	1 3/8"	60'
I83150	1 1/2" IPS	42'
I83158	1 5/8"	42'
I83200	2" IPS	36'
I83218	2 1/8"	42'
I83250	2 1/2" IPS	36'
I83258	2 5/8"	36'
I83300	3" IPS	30'
I83318	3 1/8"	30'
I83358	3 5/8"	30'
I83418	4 1/8"	18'

CLOSED CELL Pipe Insulation

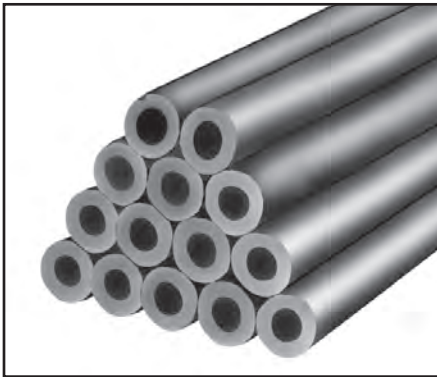

DESCRIPTION

Closed Cell Pipe Insulation is a flexible and easy-to-apply tubing product available in Semi-Slit and Self-Sealing styles. These chemically inert pipe insulations are specially formulated to retard heat gain and their closed-cell structures allow them to function as efficient insulators. The Self-Sealing version has yellow self-seal release liner that is both easy to see and peel.

APPLICATIONS

To reduce unwanted heat loss or heat gain, control condensation, decrease plumbing noise and maximize energy savings. They can be used on hot and cold water lines, refrigeration lines, air conditioning lines; line set tubing, condenser coils, and connection and distribution lines.

Closed Cell Pipe Insulation has low thermal conductivity and a very low water vapor transmission rate. This low density product demonstrates excellent thermal, physical and chemical resistant properties, and has a broad service temperature range between -90° F and 180° F (-68° C and 82° C). It can be installed in commercial, industrial, and residential insulation projects.

INSTALLATION

Closed Cell Pipe Insulation is installed by sliding the stick over pipe or tubing. For existing lines, the insulation should be slit lengthwise and fitted over the pipe. When in place, make sure all seams are adhered with contact adhesive and pressed together to form a seal. The Self-Sealing version does not require adhesive. Fittings can be fabricated from miter-cut tubular sections. Closed Cell Pipe Insulation is easily cut with a sharp knife.

OUTDOOR APPLICATIONS

Outdoor applications require a protective coating (high quality exterior acrylic latex paint) for optimum performance. For best appearance, two coats are recommended.

UNDERGROUND

For buried lines above the water table, use a clean fill such as sand (3"-5" layer) to protect Closed Cell Pipe Insulation before backfilling. It is recommended that all materials to be buried are properly sealed at all seams and butt joints with Contact Adhesive. For optimum performance, the lines should be encased in conduit to protect them from problems associated with ground water.

RESISTANCE TO MOISTURE VAPOR FLOW

The closed-cell structure effectively retards the flow of moisture vapor, and is considered a low transmittance vapor retarder. For most applications, Closed Cell Pipe Insulation needs no additional protection.

Additional vapor barrier protection may be necessary for Closed Cell Pipe Insulation when installed on low temperature surfaces or where it is exposed to continuous high humidity.

FLAME AND SMOKE RATING

Closed Cell Pipe Insulation in wall thicknesses of 1" (25mm) and below has a flame spread rating of 25 or less and a smoke development rating of 50 or less as tested by ASTM E 84; CAN/ULC-S102.2-M88 Method of Testing entitled: "Surface Burning Characteristics of Building Materials."

Numerical flammability ratings alone may not define the performance of products under actual fire conditions. They are provided only for use in the selection of products to meet limits specified, when compared to a known standard.

SPECIFICATION COMPLIANCE

Complies with requirements of:

ASTM E 84; CAN/ULC S102.2

ASTM D 1622

ASTM D 1171

ASTM C 177 or C518

ASTM E 96

PHYSICAL DATA	PROPERTIES	TEST METHODS
Material	Closed Cell Polyolefin	-
Color	Charcoal	-
Upper Use Limit	180°F (82°C) constant	-
Lower Use Limit	-90°F (-68°C)	-
Density	1.5 lbs/ft ³	ASTM D 1622
Ozone Resistant	Good	ASTM D 1171
Thermal Conductivity (K)	at 75° F (24°C) Mean Temp	ASTM C 177 or C 518
BTU-in/hr-ft ² - F° (W/m-K)	0.230 (0.033)	-
Water Absorption	0.02% by Volume	ASTM E 96
Flame Speed	Less than 25	ASTM E 84; CAN/ULC-S102.2-M88
Smoke Classification	Less than 50	ASTM E 84; CAN/ULC-S102.2-M88

THICKNESS RECOMMENDATIONS* - TO CONTROL CONDENSATION								
PIPE SIZE	LINE TEMP		LINE TEMP		LINE TEMP		LINE TEMP	
	50° F	10° C	35° F	2° C	0° F	-18° C	-20° F	-29° C
Normal Conditions (Max 85°F, 29°C - 70% R.H.)								
3/8" ID thru 1 3/8" ID	3/8"	10 mm	1/2"	13 mm	3/4"	19 mm	1"	25 mm
Over 1 3/8" thru 3" IPS	3/8"	10 mm	1/2"	13 mm	1"	25 mm	1"	25 mm
Over 3" IPS thru 4" IPS**	3/8"	10 mm	1/2"	13 mm	1"	25 mm	1"	25 mm
Over 4" IPS	1/2"	13 mm	3/4"	19 mm	1"	25 mm	1 1/4"	32 mm
Mild Conditions (Max 80°F, 26°C - 50% R.H.)								
3/8" ID thru 2 1/8" ID	3/8"	10 mm	3/8"	10 mm	3/8"	10 mm	1/2"	13 mm
Over 2 1/8" thru 3" IPS	3/8"	10 mm	3/8"	10 mm	3/8"	10 mm	1/2"	13 mm
Over 3" IPS thru 4" IPS**	3/8"	10 mm	3/8"	10 mm	1/2"	13 mm	3/4"	19 mm
Over 4" IPS	3/8"	10 mm	1/2"	13 mm	1/2"	13 mm	3/4"	19 mm
Severe Conditions (Max 90°F, 32°C - 80% R.H.)								
3/8" ID thru 1 1/8" ID	3/4"	19 mm	3/4"	19 mm	1 1/4"	32 mm	1 1/4"	32 mm
Over 1 1/8" ID thru 4" IPS	3/4"	19 mm	1"	25 mm	1 1/2"	38 mm	1 1/2"	38 mm
Over 4" IPS	3/4"	19 mm	1"	25 mm	1 1/2"	38 mm	2"	50 mm

Closed Cell Pipe Insulation in thickness notes within the specified temperature ranges will prevent condensation on indoor piping under design conditions defined below. Thickness recommendations above 1" can be sleeved to achieve thickness desired.

Normal: Maximum severity of indoor conditions seldom exceed 85° F (29° C) and 70% R.H. in United States.

Mild: Typical conditions are most air-conditioned spaces and arid climates.

Severe: Generally found in areas which excessive moisture is introduced or in poorly ventilated areas where the temperature may be depressed below the ambient. Under conditions of high humidity, additional thickness of insulation may be required.

**Available: Nom. 1/2" or Nom. 3/4" thickness only

CLOSED CELL "R" VALUES PER SQUARE FOOT					
Pipe OD or Nominal Insulation ID		R Value 3/8" (10 mm) Wall	R Value 1/2" (13 mm) Wall	R Value 3/4" (19 mm) Wall	R Value 1" (25 mm) Wall
3/8"	10 mm	2.687	3.844	-	-
1/2"	13 mm	2.490	3.582	6.027	-
5/8"	16 mm	2.357	3.375	5.653	8.189
3/4"	19 mm	2.680	3.223	5.374	7.767
7/8"	22 mm	2.187	3.107	5.155	7.435
1 1/8"	29 mm	2.082	4.835	4.835	6.941
1 3/8"	35 mm	2.011	2.822	4.610	6.588
1 5/8"	41 mm	1.959	2.737	4.420	6.323
1 7/8"	-	1.920	2.672	4.313	6.115
2 1/8"	54 mm	1.889	2.620	4.209	5.948
2 3/8"	-	1.864	2.578	4.124	5.810
2 5/8"	67 mm	1.844	2.544	4.053	5.695
2 7/8"	-	1.827	2.514	3.993	5.596
3 1/8"	79 mm	1.812	2.490	3.942	5.512
3 1/2"	-	-	2.459	3.877	5.404
3 5/8"	92 mm	-	2.449	-	5.373
4"	105 mm	-	2.425	-	-
4 1/8"	-	-	2.418	-	5.264
4 1/2"	-	-	2.399	-	5.196

Note: "R" factors were calculated from using the K factor of .230 (75°F, 24°C mean temp) and nominal wall thickness in each case. Lower operating temperatures will result in improved R values.

Semi-Slit Pipe Insulation



- 100% closed cell polyethylene
- UPS shippable cartons - CARTON QUANTITIES ONLY
- For outdoor use, paint with a high quality exterior acrylic latex paint

SPECIFICATIONS:

Density: 1.5 lbs./cubic foot; Mold growth: None;
 Temperature Range: -90° to 180°F; Flame/Smoke:
 25/50; Water vapor permeability: less than .02
 inches; Ozone resistance: Good

3/8" Wall Thickness

PART NO.	NOMINAL ID	R VALUES	CTS	IPS	FT/BOX
I50058	5/8"	2.357	1/2"	3/8"	408'
I50075	3/4"	2.680	5/8"	-	360'
I50078	7/8"	2.187	3/4"	1/2"	300'
I50118	1 1/8"	2.082	1"	3/4"	240'
I50138	1 3/8"	2.011	1 1/4"	1"	192'
I50158	1 5/8"	1.959	1 1/2"	1 1/4"	132'
I50178	2"	1.920	-	1 1/2"	108'
I50218	2 1/8"	1.889	2"	-	90'
I50238	2 3/8"	1.864	-	2"	90'
I50258	2 5/8"	1.844	2 1/2"	-	72'

1/2" Wall Thickness

PART NO.	NOMINAL ID	R VALUES	CTS	IPS	FT/BOX
I51058	5/8"	3.375	1/2"	3/8"	306'
I51078	7/8"	3.107	3/4"	1/2"	240'
I51118	1 1/8"	4.835	1"	3/4"	180'
I51138	1 3/8"	2.822	1 1/4"	1"	150'
I51158	1 5/8"	2.737	1 1/2"	1 1/4"	120'
I51178	2"	2.672	-	1 1/2"	90'
I51218	2 1/8"	2.620	2"	-	84'
I51238	2 3/8"	2.578	-	2"	66'
I51258	2 5/8"	2.544	2 1/2"	-	60'

3/4" Wall Thickness

PART NO.	NOMINAL ID	R VALUES	CTS	IPS	FT/BOX
I54050	1/2"	6.027	3/8"	1/4"	204'
I54058	5/8"	5.653	1/2"	3/8"	180'
I54075	3/4"	5.374	5/8"	1/2"	168'
I54078	7/8"	5.155	3/4"	-	156'
I54118	1 1/8"	4.835	1"	-	102'
I54138	1 3/8"	4.610	1 1/4"	1"	90'
I54158	1 5/8"	4.420	1 1/2"	1 1/4"	84'
I54178	2"	4.313	-	1 1/2"	66'
I54218	2 1/8"	4.209	2"	-	54'
I54258	2 5/8"	4.053	2 1/2"	-	48'

1" Wall Thickness

PART NO.	NOMINAL ID	R VALUES	CTS	IPS	FT/BOX
I55058	5/8"	8.189	1/2"	3/8"	108'
I55075	3/4"	7.767	5/8"	1/2"	102'
I55078	7/8"	7.435	3/4"	-	90'
I55118	1 1/8"	6.941	1"	-	90'
I55138	1 3/8"	6.588	1 1/4"	1"	72'
I55158	1 5/8"	6.323	1 1/2"	1 1/4"	60'
I55178	2"	6.115	-	1 1/2"	54'
I55218	2 1/8"	5.948	2"	-	48'
I55258	2 5/8"	5.695	2 1/2"	-	42'

Self-Sealing Pipe Insulation



- 100% closed cell polyethylene
- UPS shippable cartons - CARTON QUANTITIES ONLY
- Complete seal on hot or cold pipe
- Two strips of self-adhesive seal easily at any length

SPECIFICATIONS:

Density: 1.5 lbs./cubic foot; Mold growth: None;
 Temperature Range: -90° to 180°F; Flame/Smoke:
 25/50; Water vapor permeability: less than .02
 inches; Ozone resistance: Good



3/8" Wall Thickness

PART NO.	NOMINAL ID	R VALUES	CTS	IPS	FT/BOX
I52058	5/8"	2.357	1/2"	3/8"	408'
I52034	3/4"	2.680	5/8"	-	360'
I52078	7/8"	2.187	3/4"	1/2"	300'
I52118	1 1/8"	2.082	1"	3/4"	240'
I52138	1 3/8"	2.011	1 1/4"	1"	192'
I52158	1 5/8"	1.959	1 1/2"	1 1/4"	132'
I52178	2"	1.920	-	1 1/2"	108'
I52218	2 1/8"	1.889	2"	-	90'
I52238	2 3/8"	1.864	-	2"	90'
I52258	2 5/8"	1.844	2 1/2"	-	72'
I52318	3 1/8"	1.812	3"	-	54'

1/2" Wall Thickness

PART NO.	NOMINAL ID	R VALUES	CTS	IPS	FT/BOX
I53058	5/8"	3.375	1/2"	3/8"	306'
I53075	3/4"	3.223	3/4"	1/2"	270'
I53078	7/8"	3.107	3/4"	1/2"	240'
I53118	1 1/8"	4.835	1"	3/4"	180'
I53138	1 3/8"	2.822	1 1/4"	1"	150'
I53158	1 5/8"	2.737	1 1/2"	1 1/4"	120'
I53178	2"	2.672	-	1 1/2"	90'
I53218	2 1/8"	2.620	2"	-	84'
I53238	2 3/8"	2.578	-	2"	66'
I53258	2 5/8"	2.544	2 1/2"	-	60'
I53318	3 1/8"	2.490	3"	-	48'
I53312	3 1/2"	2.459	-	3"	42'
I53358	3 5/8"	2.449	3 1/2"	-	42'
I53418	4 1/8"	2.418	4"	-	30'
I53412	4 1/2"	2.399	-	4"	30'

3/4" Wall Thickness

PART NO.	NOMINAL ID	R VALUES	CTS	IPS	FT/BOX
I56058	5/8"	5.653	1/2"	3/8"	180'
I56075	3/4"	5.374	5/8"	1/2"	168'
I56078	7/8"	5.155	3/4"	1/2"	156'
I56118	1 1/8"	4.835	1"	3/4"	102'
I56138	1 3/8"	4.610	1 1/4"	1"	90'
I56158	1 5/8"	4.420	1 1/2"	1 1/4"	84'
I56218	2 1/8"	4.209	2"	-	54'

1" Wall Thickness

PART NO.	NOMINAL ID	R VALUES	CTS	IPS	FT/BOX
I57058	5/8"	8.189	1/2"	3/8"	108'
I57078	7/8"	7.435	3/4"	1/2"	90'
I57115	3/4"	7.767	5/8"	-	102'
I57118	1 1/8"	6.941	1"	-	90'
I57138	1 3/8"	6.588	1 1/4"	1"	72'
I57158	1 5/8"	6.323	1 1/2"	1 1/4"	60'
I57178	2"	6.115	-	1 1/2"	54'
I57218	2 1/8"	5.948	2"	-	56'
I57238	2 3/8"	5.810	-	2"	42'
I57258	2 5/8"	5.695	2 1/2"	-	36'

Insulation Contact Adhesive



- Slow tack
- Brush top cans
- For use with rubber insulation only
- CARTON QUANTITIES ONLY
- MOTOR FREIGHT ONLY/FLAMMABLE

PART NO.	SIZE	CTN QTY
IA2050	1/2 pint	48
IA2100	1 pint	24

Insulation Protective Coating



PART NO.	SIZE	CTN QTY
IPC004	1 gallon	4

Insulation Tape



PART NO.	DESCRIPTION	CTN QTY
INT001	1/8" x 2" x 30' cork tape	12
INT002	1/8" x 2" x 30' tape	12

Flanged Dielectric Union



- Temperature range: 180°F at 200 PSI
- Maximum temperature 200°F

PART NO.	FIP x COPPER SWEAT	CTN QTY
D06250	2 1/2" x 2 1/2"	1
D06300	3" x 3"	1
D06400	4" x 4"	1

Thermal Expansion Tanks



- Designed for the protection of potable hot water systems
- Install between the backflow preventer and the water heater
- Specifications:

Factory pre-charge: 40psi
 System Connection: 304 Stainless Steel
 Diaphragm: Butyl Rubber
 Liner Material: Food Grade Polypropylene
 Max. Operating Temp.: 200°F
 Max. Operating Pressure: 150psi

PART NO.	DESCRIPTION	CTN. QTY.	PALLET QTY.
R15202	2 gallon tank	1	150
R15204	4-1/2 gallon tank	1	80

Dual Port Self Cleaning Thermal Expansion Tank



- Designed for the protection of potable hot water systems
- Install between the backflow preventer and the water heater
- Specifications:

Factory pre-charge: 15psi
 System Connection: 304 Stainless Steel
 Diaphragm: Butyl Rubber
 Liner Material: Food Grade Polypropylene
 Max. Operating Temp.: 200°F
 Max. Operating Pressure: 150psi

PART NO.	DESCRIPTION	CTN. QTY.	PALLET QTY.
R15206	2 gallon tank	1	150

Dielectric Union



Female x Sweat



Male x Sweat

- Prevents electrolysis or galvanic action when connecting dissimilar metals
- Residential or commercial use
- Zinc plated forged steel
- Solder ends conform to ANSI B16.19
- EPDM washer, ABS fiber sleeve
- Threads conform to ANSI B2.1
- Pressure rated at 250 PSI at 180°F

Female x Sweat

PART NO.	FIP x COPPER SWEAT	OD	CTN QTY
D06050	1/2" x 1/2"	5/8"	12
D06075	3/4" x 3/4"	7/8"	12
D06100	1" x 1"	1 1/8"	12
D06125	1 1/4" x 1 1/4"	1 3/8"	6
D06150	1 1/2" x 1 1/2"	1 5/8"	6
D06200	2" x 2"	2 1/8"	6

Reducing

PART NO.	FIP x COPPER SWEAT	OD	CTN QTY
D06350	3/4" x 1/2"	5/8"	12

LEAD FREE

PART NO.	FIP x COPPER SWEAT	OD	CTN QTY
D07050	1/2" x 1/2"	5/8"	24
D07075	3/4" x 3/4"	7/8"	24
D07100	1" x 1"	1 1/8"	12
D07125	1 1/4" x 1 1/4"	1 3/8"	6
D07150	1 1/2" x 1 1/2"	1 5/8"	6
D07200	2" x 2"	2 1/8"	6
D07350	3/4" x 1/2"	5/8"	24

Male x Sweat

PART NO.	MIP x COPPER SWEAT	OD	CTN QTY
D06005	1/2" x 1/2"	7/8"	12
D06750	3/4" x 3/4"	7/8"	12

Reducing

PART NO.	MIP x COPPER SWEAT	OD	CTN QTY
D06755	3/4" x 1/2"	5/8"	12

LEAD FREE

PART NO.	MIP x COPPER SWEAT	OD	CTN QTY
D07025	1/2" x 1/2"	5/8"	24
D07750	3/4" x 3/4"	7/8"	24
D07755	3/4" x 1/2"	5/8"	24

Universal Copper Thermocouple



- All copper with brass fittings
- Adaptable to 5 different pilot valves
- Kit includes 2 clips and nuts
- Individually carded

PART NO.	LENGTH	CTN QTY
J36118	18"	10
J36124	24"	10
J36130	30"	10
J36136	36"	10
J36148	48"	10

Gasket and Insert for Dielectric Union



Insert



Gasket

- For water
- 200°F temperature rating
- CARTON QUANTITIES ONLY

Insert		
PART NO.	DESCRIPTION	CTN QTY
D06800	1/2" insert	25
D06801	3/4" insert	25
D06802	1" insert	25
D06803	1 1/4" insert	25
D06804	1 1/2" insert	25
D06805	2" insert	25
Gasket		
PART NO.	DESCRIPTION	CTN QTY
D06850	1/2" gasket	25
D06875	3/4" gasket (EPDM rubber)	25
D06900	1" gasket	25
D06901	1 1/4" gasket	25
D06902	1 1/2" gasket	25
D06903	2" gasket	25

Dielectric Nipple



- 180° maximum temperature
- Prevents corrosion, lime and scale buildup
- Adds years of life to any water system
- For use on water heaters, dishwashers, water filtration systems
- Electroplated steel casing with non-corrosion thermoplastic lining

PART NO.	SIZE	CTN QTY
D06753	3/4" MIP x 3" length	1
D06450	1/2" MIP x 3" length	1
D06500	1" MIP x 3" length	1
D06510	1" MIP x 4" length	1
D06525	1 1/4" MIP x 4" length	1
D06550	1 1/2" MIP x 4" length	1
D06600	2" MIP x 6" length	1
D06650	2 1/2" MIP x 6" length	1
D06700	3" MIP x 6" length	1

PlumBite Push On Water Heater Connector



- Leak-Free, Tool-Free & Solvent Free
- Approved for behind-the-wall installation
- Fittings may be reused if necessary
- Internal PEX Tube insert provided for Perfect PEX connections
- For use with hot and cold potable water
- Operating temperature 0°F to 200°F, 200 PSI

PART NO.	SIZE	CTN. QTY.
C76605	1/2" Push Fitting x 3/4" FIP x 12"	1
C76606	1/2" Push Fitting x 3/4" FIP x 15"	1
C76607	1/2" Push Fitting x 3/4" FIP x 18"	1
C76608	1/2" Push Fitting x 3/4" FIP x 24"	1
C76612	3/4" Push Fitting x 3/4" FIP x 12"	1
C76613	3/4" Push Fitting x 3/4" FIP x 15"	1
C76614	3/4" Push Fitting x 3/4" FIP x 18"	1
C76615	3/4" Push Fitting x 3/4" FIP x 24"	1

Corrugated Water Heater Connector

- Corrugated for easy flex on water heaters and softeners
- Includes rubber washers

Copper



PART NO.	FPT x LENGTH	CTN QTY
J34712	3/4" x 12"	25
J34715	3/4" x 15"	25
J34718	3/4" x 18"	25
J34724	3/4" x 24"	25



PART NO.	FIP x SWT x LENGTH	CTN QTY
J35712	3/4" x 3/4" x 12"	25
J35715	3/4" x 3/4" x 15"	25
J35718	3/4" x 3/4" x 18"	25
J35724	3/4" x 3/4" x 24"	25



PART NO.	FIP x MIP x LENGTH	CTN QTY
J36712	3/4" x 3/4" x 12"	1
J36715	3/4" x 3/4" x 15"	1
J36718	3/4" x 3/4" x 18"	1
J36724	3/4" x 3/4" x 24"	1

Stainless Steel



PART NO.	MIP x FIP x LENGTH	CTN QTY
J38712	3/4" x 3/4" x 12"	50
J38715	3/4" x 3/4" x 15"	50
J38718	3/4" x 3/4" x 18"	50
J38724	3/4" x 3/4" x 24"	50



PART NO.	FIP x FIP x LENGTH	CTN QTY
J39712	3/4" x 3/4" x 12"	50
J39715	3/4" x 3/4" x 15"	50
J39718	3/4" x 3/4" x 18"	50
J39724	3/4" x 3/4" x 24"	50

Braided Stainless Steel Water Heater Connector

- UPC listed
- S04350, S04351, S04352 - now LEAD FREE



PART NO.	FIP x LENGTH	CTN QTY
S04350	3/4" x 12"	25
S04351	3/4" x 18"	25
S04352	3/4" x 24"	25



PART NO.	FIP x COMP x LENGTH	CTN QTY
S04353	3/4" x 3/4" x 12"	25
S04354	3/4" x 3/4" x 18"	25
S04355	3/4" x 3/4" x 24"	25



PART NO.	FIP x MIP x LENGTH	CTN QTY
S04356	3/4" x 3/4" x 12"	25
S04357	3/4" x 3/4" x 18"	25
S04358	3/4" x 3/4" x 24"	25



PART NO.	MIP x COMP x LENGTH	CTN QTY
S04359	3/4" x 3/4" x 12"	25
S04360	3/4" x 3/4" x 18"	25
S04361	3/4" x 3/4" x 24"	25

Water Heater Stand



- Galvanized
- Snap-in legs
- Easy to assemble
- Rating approval at 2,000 lbs. static weight

PART NO.	DESCRIPTION	CTN QTY
J36200	18" square x 17" high water heater stand	1

Water Heater Stand



- No assembly required
- 3/4 tubular steel construction
- Non-rust paint
- 800 lbs. static weight

PART NO.	DESCRIPTION	CTN QTY
J36300	25 1/2" x 17" high water heater stand	1
J36250	28" x 17" high water heater stand	1

Stand-rite Water Heater Stand



- Lab tested
- Meets UPC requirements
- Heavy duty
- Corrosion resistant
- 14 gauge galvanized steel
- Top 21.5" x 21.5"
- Rated up to 900 pounds
- For water heaters up to 65 gallons
- Includes mounting clips for securing to wall/floor
- Quick assembly

PART NO.	DESCRIPTION	CTN QTY
J36400	Water heater stand	1

Water Heater Safety Pan



- Supplied with 1" hookup adapter for any drain type (J34-800)
- 2 1/2" depth
- High impact plastic
- Southern Building Code and natural gas approved
- CARTON QUANTITIES ONLY

PART NO.	BOTTOM ID	TOP ID	CTN QTY
J36018	19"	20 1/2"	20
J36022	22"	22 1/2"	20
J36024	24"	25 1/2"	20
J36026	26"	27 1/2"	10
J36030	30"	31 1/2"	5

Galvanized Hot Water Heater Pans



- 24 gauge
- Flared sides
- 1" fitting (J34-800)

PART NO.	DESCRIPTION	CTN QTY
J37022	22" x 22" x 4"	1
J37024	24" x 24" x 4"	1
J37026	26" x 26" x 4"	1
J37028	28" x 28" x 4"	1
J37030	30" x 30" x 4"	1

Water Heater Pan



Seamless Galvanized Corner



- Seamless galvanized water heater pans are holded not welded
- 1" drain connector included (J34-800)
- One piece stamped aluminum .032 mil (20 gauge)
- Aluminum pans comply with SBCCI, sec. 1213.7

Round Aluminum

PART NO.	DESCRIPTION	CTN QTY
J38020	20" round water heater pan	1
J38022	22" round water heater pan	1
J38024	24" round water heater pan	1
J38026	26" round water heater pan	1
J38030	30" round water heater pan	1

Seamless Galvanized

PART NO.	DESCRIPTION	CTN QTY
J39019	19" seamless water heater pan	1
J39023	23" seamless water heater pan	1
J39027	27" seamless water heater pan	1
J39030	30" seamless water heater pan	1

Water Heater Pan Adapter



- 1" PVC
- Washer and locknut
- Fits all Jones Stephens pans

PART NO.	DESCRIPTION	CTN QTY
J34800	1" Adapter	1

Run-Off Tube



- UL listed
- For water heaters
- Electroplated fittings
- 230°F temperature rating
- Hand tighten to T and P valve

PART NO.	DESCRIPTION	CTN QTY
J34975	3/4" NPT x 60" side mount	125
J34980	3/4" NPT top mount	25
J34970	3/4" NPT x 60" side mount	15

Gas Testing Equipment



- Large 4" face
- Class 1A gauge
- 5 lb. gas test gauge/15 lb. gas test gauge
- 1/10 # increments
- Inches of mercury scale
- External set hand
- Bellows design
- 1/4 NPT connection
- Gauge meets all requirements of the City of Houston code Word 94-108, Section 1204.3.2, revised January 18, 2001
- ALL SALES FINAL; NO WARRANTY; NO RETURN

PART NO.	DESCRIPTION	CTN QTY
G60055	15 lb. gas test gauge only	1
G65055	15 lb. gauge, body and valve-complete	1
G60005	5 lb. gas test gauge only	1
G64055	5 lb. gauge, body and valve-complete	1

2 1/2" Face Liquid Filled Pressure Gauge



- +/- 1.5% accuracy
- Glycerin filled for use where vibration or pressure pulsation occur
- -50 to 150°F operating temperature
- 1/4" NPT bottom connection
- Polished 304 stainless steel case with vent plug

PART NO.	DESCRIPTION	CTN QTY
J40553	0-30 PSI	1
J40554	0-60 PSI	1
J40555	0-100 PSI	1
J40556	0-200 PSI	1
J40557	0-300 PSI	1

Pressure Gauge



- 1/4" MIP brass lower connection
- Applicable with air, water, oil and gas - anything which does not attack brass
- Not for use on oxygen service
- Individually boxed
- Steel case
- Shatterproof face
- Class 2.5-2% accuracy

2" Face

PART NO.	PRESSURE RATING	CTN QTY
G60015	15 PSI	10
G60030	30 PSI	10
G60060	60 PSI	10
G60100	100 PSI	10
G60160	160 PSI	10
G60200	200 PSI	10
G60300	300 PSI	10

2 1/2" Face

PART NO.	PRESSURE RATING	CTN QTY
G61015	15 PSI	10
G61030	30 PSI	10
G61060	60 PSI	10
G61100	100 PSI	10
G61160	160 PSI	10
G61200	200 PSI	10
G61300	300 PSI	10

3 1/2" Face

PART NO.	PRESSURE RATING	CTN QTY
G62030	30 PSI	5
G62060	60 PSI	5
G62100	100 PSI	5
G62200	200 PSI	5
G62300	300 PSI	5

Pigtail Syphon



- For use with gauges on steam line
- 1/4" MPT x 1/4" MPT
- Steel construction

PART NO.	DESCRIPTION	CTN QTY
G60000	Straight	10
G60001	90° Angle	10

Water Test Gauge



- Individually boxed
- 3/4" brass hose connection
- Steel case with 2 1/2" shatterproof face

PART NO.	DESCRIPTION	CTN QTY
J66300	300 PSI	10
J66301	300 PSI with indicator	10

Silkcock/Water or Gas Test Gauge Assembly



- Brass air valve
- Individually boxed
- Adapts to 3/4" male garden hose or 3/4" MIP
- Comes with garden hose adapter
- Steel case with 2" shatterproof face

PART NO.	DESCRIPTION	CTN QTY
G64101	200 PSI	10

5 Pound Gas Test Gauge



- 1/4" NPT
- 2 1/2" diaphragm
- 1/10 # increments
- For building code inspection

PART NO.	DESCRIPTION	CTN QTY
G61005	5 lb. gas test gauge	1

Gas Test Gauge



- 2" steel case gauge on 15 lb.
- 5 lb. is marked in 1/10 lb. increments
- 15 lbs. is marked in 1/10 lb. increments
- Plated body with 3/4" FIP inlet
- 2 1/2" diaphragm on 5 lb.
- Adapts to 3/4" MPT
- Brass air valve
- Individually boxed

PART NO.	DESCRIPTION	CTN QTY
G64015	15 lb. gas test gauge assembly	1
G64005	5 lb. gas test gauge assembly	1

Test Gauge Assembly

Bell Type



PART NO.	DESCRIPTION	CTN QTY
G66015	13# x 3/4" FIP	1
G66030	30# x 3/4" FIP	1
G66060	60# x 3/4" FIP	1
G66100	100# x 3/4" FIP	1
G67015	15# x 1" FIP	1
G67030	30# x 1" FIP	1
G67060	60# x 1" FIP	1
G67100	100# x 1" FIP	1
G66000	3/4" Bell body (less air valve)	1
G66002	3/4" Bell body (with air valve)	1
G67000	1" Bell body (less air valve)	1
G67002	1" Bell body (with air valve)	1

Gas Test Assembly



- 4" face and pressure snubber
- Regulates air to an even flow
- Over pressurization will void the warranty
- Protects the diaphragm from compressed air damage
- Class 1A gauge

PART NO.	DESCRIPTION	CTN QTY
G64155	5 lb. Test Assembly	1
G65155	15 lb. Test Assembly	1

Gas Test Gauge Assembly



- Adapts to 3/4" MPT
- Steel case with 2" shatterproof face
- Plated body with 3/4" FIP inlet
- Brass air valve
- Individually boxed

PART NO.	DESCRIPTION	CTN QTY
G64030	30 PSI	10
G64060	60 PSI	10
G64100	100 PSI	10
G64160	160 PSI	10
G64200	200 PSI	10
G64333	300 PSI	10
G64000	1/4" air valve and cap	20
G64001	Gas test body only	20
G64002	1/8" air valve and cap	20
G64020	Gas test body and air valve assembly	20

Tridicator



- 0-55 PSI
- 70°F to 250°F temperature range

PART NO.	DESCRIPTION	CTN QTY
J40550	2 1/2" face angle 2 1/4" stem (1/4" NPT)	1
J40551	2 1/2" face angle 2 1/2" stem (1/4" NPT)	1
J40558	2 1/2" face angle 1" stem (1/4" NPT)	1
J40560	3 1/2" face angle 2 3/4" stem (1/2" NPT)	1

Vacuum Gauge



- 1/4" brass lower connection
- -30 to 0 inch Hg
- Black steel case with bronze internals

PART NO.	DESCRIPTION	CTN QTY
G63001	Vacuum gauge (2" face)	1

Pressure Snubber



- Use on lines with noticeable pressure changes/oscillations
- Bronze body and core
- 1000 PSI maximum

PART NO.	DESCRIPTION	CTN QTY
G64300	1/4" NPT for air or gas	1
G64301	1/4" NPT for oil, steam or water	1

Needle Valve for Pressure Gauge



- 1/4" NPT
- Brass body, seat, stem and handle
- 300°F maximum temperature
- Female x female
- Teflon packing
- 2000 PSI

PART NO.	DESCRIPTION	CTN QTY
G64004	1/4" needle valve	1

Hot Water/Refrigerant Line Thermometer

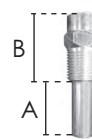

- Straight or angle pattern
- Steel or brass well
- 40°-280°F x 5°F (5-120°C x 2°C)
- 1/2" NPT; 1" stem

PART NO.	DESCRIPTION	DIM (A)	DIM (B)	CTN QTY
J40500	Straight pattern steel well	1"	1/2" NPT	1
J40501	Straight pattern brass well	1"	1/2" NPT	1
J40502	Angle pattern steel well	1"	1/2" NPT	1
J40503	Angle pattern brass well	1"	1/2" NPT	1

Dial Thermometer



- 2 1/2" face
- 5° increments
- Dual scale: 40°-240°/0°-120°C
- Brass wells/removable thermometers
- Thermometers are supplied with wells

PART NO.	DESCRIPTION	CTN QTY
J40702	3/4" SWT connection	1
J40703	1/2" MIP connection	1
J40704	3/4" SWT well	1
J40705	1/2" MIP well	1

Weksler Industrial Multi-Angle Thermometer

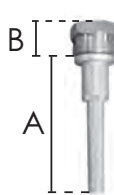

- No well provided; order wells separately
- 9" scale, red-reading mercury tubes
- Molded cyclocac case with glass window
- Adjustable to any angle
- Accurate to +/- one scale division
- Must have well

PART NO.	DESCRIPTION	DIM (A)	DIM (B)	CTN QTY
J40505	Hot water 30°-240°F	3 1/2" stem	1" NPSM	1
J40506	Cold water 0°-120°F	3 1/2" stem	1" NPSM	1
J40510	Standard brass well	2 1/2" stem	3/4" NPT	1
J40511	Extended well	1 3/4" stem	3/4" NPT	1

Bi-Metal Dial Thermometer

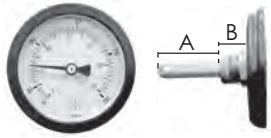

- For commercial or home heating systems
- 1/2" NPT
- 20°-240°F temperature range
- 3" dial in steel case
- Angle has back connection; straight has bottom connection

PART NO.	DESCRIPTION	DIM (A)	DIM (B)	CTN QTY
J40561	Angle outlet with brass well	1 1/8" stem	1/2" NPT	1
J40562	Straight outlet with brass well	2 3/8" stem	1/2" NPT	1

Brass Wells



- Solid brass construction
- 1 1/2" stem
- 1/2" MPT x 1/4" FPT threads

PART NO.	DESCRIPTION	CTN QTY
J40563	Brass wells for J40-562	1

Pocket Test Thermometer



- 2% accuracy for hot and cold
- Pocket clip on sheath; 5" stem

PART NO.	DESCRIPTION	CTN QTY
J40700	Cold thermometer (-40° to 160°F)	1
J40701	Hot thermometer (0° to 220°F)	1

Natural Polyethylene Tubing



- Non-toxic, 100% virgin material
- 100' coils in dispenser box
- FDA
- -40°F to +135°F

PART NO.	OD	ID	PSI	WALL	CTN QTY
T25250	1/4"	.170"	120	.040	100'
T25312	5/16"	.187"	150	.040	100'
T25375	3/8"	.250"	125	.062	100'
T25500	1/2"	.375"	95	.062	100'
T25625	5/8"	.500"	75	.500	100'

Clear Vinyl Tubing



- 75 duro clear
- -5°F to +125°F
- Self-dispensing cartons
- FDA

PART NO.	OD	ID	WALL	WPPSI	CTN QTY
T26124	3/16"	1/8"	1/32"	50	100'
T26125	1/4"	1/8"	1/16"	80	100'
T26186	1/4"	3/16"	1/32"	40	100'
T26187	5/16"	3/16"	1/16"	60	100'
T26250	3/8"	1/4"	1/16"	55	100'
T26252	1/2"	1/4"	1/8"	90	100'
T26312	7/16"	5/16"	1/16"	50	100'
T26313	1/2"	5/16"	3/32"	60	100'
T26375	1/2"	3/8"	1/16"	45	100'
T26376	9/16"	3/8"	3/32"	55	100'
T26377	5/8"	3/8"	1/8"	65	100'
T26498	5/8"	1/2"	1/16"	30	100'
T26500	3/4"	1/2"	1/8"	45	100'
T26626	3/4"	5/8"	1/16"	30	100'
T26625	7/8"	5/8"	1/8"	40	100'
T26750	1"	3/4"	1/8"	35	100'
T26875	1 1/8"	7/8"	1/8"	30	50'
T26000	1 1/4"	1"	1/8"	28	50'

Soft Aluminum Tubing



- 50' coils
- Alloy 3003-O, ASTM B-483

PART NO.	OD	WALL	CTN QTY
T27125	1/8"	.025	1/10
T27188	3/16"	.028	1/10
T27250	1/4"	.032	1/10
T27313	5/16"	.035	1/10
T27375	3/8"	.035	1/10
T27438	7/16"	.035	1/10
T27500	1/2"	.035	1/10
T27625	5/8"	.035	1/10

Stud Protectors and Plate



- Protects piping and wiring from nails
- CARTON QUANTITIES ONLY

PART NO.	SIZE	GAUGE	CTN QTY
S33001	1 1/2" x 6"	18	100
S33002	1 1/2" x 3"	18	100
S33003	5" x 8" (not self nailed)	16	50
S33005	1 1/2" x 6"	16	100
S33006	1 1/2" x 5"	18	100
S33010	1 1/2" x 6"	22	100
S33011	1 1/2" x 3"	22	100
S33012	3 1/2" x 6" (not self nailed)	16	25
S33014	3 1/2" x 6" (self nailed)	16	25

Interlocking Stud Guard



- CARTON QUANTITIES ONLY

PART NO.	SIZE	GAUGE	CTN QTY
S33004	1 1/2" x 6"	20	100
S33007	1 1/2" x 6"	16	100
S33016	3 1/2" x 6"	16	25

Stud Shoe



- 18 gauge galvanized
- Four nail holes on each side
- Pipe opening accommodates 2" IPS or smaller pipe
- Stud/joist reinforcement when drilling or notching for pipe runs
- CARTON QUANTITIES ONLY

PART NO.	DESCRIPTION	CTN QTY
S33021	Single stud shoe	50
S33022	Double stud shoe	25
S33023	Triple stud shoe	10

Stud Guard



- 6 Holes
- 2 Nailers
- Protects pipes
- CARTON QUANTITIES ONLY

PART NO.	SIZE	GAUGE	CTN QTY
S33013	5" x 8"	16	25

Stud Guard



- CARTON QUANTITIES ONLY

PART NO.	SIZE	GAUGE	CTN QTY
S33318	3 1/2" x 18"	16	25

Stud Guard



- 20 Holes
- CARTON QUANTITIES ONLY

PART NO.	SIZE	GAUGE	CTN QTY
S33518	5" x 18"	16	15

Stud Guard



S180032

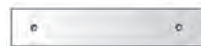

S16006



S163566

- CARTON QUANTITIES ONLY

Self Nailing Stud Guard with 2 Holes Centered

PART NO.	SIZE	GAUGE	CTN QTY
S180032	1 1/2" x 3"	18	200

2 Hole Stud Guard

PART NO.	SIZE	GAUGE	CTN QTY
S16006	1 1/2" x 6"	16	100

6 Hole Stud Guard

PART NO.	SIZE	GAUGE	CTN QTY
S163566	3 1/2" x 6"	16	25

Self Nailed Stud Guard

PART NO.	SIZE	GAUGE	CTN QTY
S16009	1 1/2" x 9"	16	100
S16012	1 1/2" x 12"	16	100
S16018	1 1/2" x 18"	16	50
S16024	1 1/2" x 24"	16	25
S20012	1 1/2" x 12"	20	100
S20009	1 1/2" x 9"	20	100
S16005	1 1/2" x 5"	16	100
S16003	1 1/2" x 3"	16	100

F.H.A. Strap - Galvanized Steel



- Tie plates
- CARTON QUANTITIES ONLY

PART NO.	SIZE	GAUGE	CTN QTY
F12009	1 1/2" x 9"	12	50
F18009	1 1/2" x 9"	18	100
F12012	1 1/2" x 12"	12	50
F18012	1 1/2" x 12"	18	100
F12018	1 1/2" x 18"	12	50
F18018	1 1/2" x 18"	18	100
F12024	1 1/2" x 24"	12	50
F18024	1 1/2" x 24"	18	100

F.H.A. Strap



- CARTON QUANTITIES ONLY

PART NO.	SIZE	GAUGE	CTN QTY
F18309	3" x 9"	18	50
F18312	3" x 12"	18	50
F18318	3" x 18"	18	50
F18324	3" x 24"	18	50

F.H.A. Strap

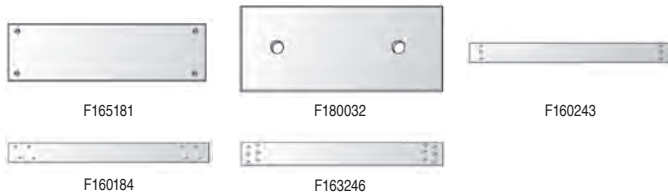

• CARTON QUANTITIES ONLY

One Hole in Each Corner

PART NO.	SIZE	GAUGE	CTN QTY
F165181	5" x 18"	16	15

2 Holes

PART NO.	SIZE	GAUGE	CTN QTY
F180032	1 1/2" x 3"	18	200

3 Holes Vertically Aligned

PART NO.	SIZE	GAUGE	CTN QTY
F160123	1 1/2" x 12"	16	50
F160183	1 1/2" x 18"	16	50
F160243	1 1/2" x 24"	16	50
F160363	3" x 6"	16	50
F160393	3" x 9"	16	50
F160063	1 1/2" x 6"	16	50
F160093	1 1/2" x 9"	16	50

Standard F.H.A. with 4 Offset Holes

PART NO.	SIZE	GAUGE	CTN QTY
F14012	1 1/2" x 12"	14	50
F16012	1 1/2" x 12"	16	50
F160184	1 1/2" x 18"	16	50
F160094	1 1/2" x 9"	16	50

Standard F.H.A. with 6 Offset Holes

PART NO.	SIZE	GAUGE	CTN QTY
F160126	1 1/2" x 12"	16	50
F16016	1 1/2" x 16"	16	50
F160186	1 1/2" x 18"	16	50
F160246	1 1/2" x 24"	16	50
F163186	3" x 18"	16	50
F163246	3" x 24"	16	50
F165186	5" x 18"	16	15

Galvanized Bracket



- For use on sinks, lavatories and toilets on 16" center spuds
- For use with 1/2" and 3/4" CPVC; 1/2", 3/4" and 1" copper or PEX
- 1 3/8" keyed holes, 20" long
- Use with B00016, B00017, B00018 and B00013
- CARTON QUANTITIES ONLY

PART NO.	HR #	DESCRIPTION	CTN QTY
B00001	103-18	1/2" - 1" x 20"	50

Flat Copper Plated Bracket



- For use on sinks, lavatories or other fixtures
- Use for 1/2" copper pipe
- CARTON QUANTITIES ONLY

PART NO.	HR #	DESCRIPTION	CTN QTY
B00003	101-18	1/2" x 20"	50
B00021	101-26	1/2" x 26"	50

Flat Copper Plated Bracket



- For use on water heater connections
- Use for 3/4" and 1" copper pipe
- CARTON QUANTITIES ONLY

PART NO.	HR #	DESCRIPTION	CTN QTY
B00004	102-18	3/4" - 1" x 20"	50

Flat Copper Plated Bracket



- For use on 1/2", 3/4" or 1" copper pipe
- CARTON QUANTITIES ONLY

PART NO.	HR #	DESCRIPTION	CTN QTY
B00005	107-18	1/2" - 1" x 20"	50

Flat Copper Plated Bracket



- Copper-Bonded™ steel
- For support of 1/2" and 3/4" pipes on 4" or 8" centers
- Positions copper water supplies for sinks, water closets, and other fixtures
- 25 lb. load rating
- CARTON QUANTITIES ONLY

PART NO.	HR #	DESCRIPTION	CTN QTY
B00025	150-20	1/2" - 3/4" x 20"	50

Carrier Bracket



- Copper plated
- Secures 1" stub out at 11 1/2" above the rim
- CARTON QUANTITIES ONLY

PART NO.	HR #	DESCRIPTION	CTN QTY
B00022	114-C	Carrier Bracket	6
B00023	114-R	Carrier Bracket	6

Holdrite Bracket



- 150 lb. load capacity
- Can attach to stud or directly to wall

PART NO.	HR #	DESCRIPTION	CTN QTY
B00024	V2	Pipe Bracket	25

Extruded Hole Copper Plated Bracket



- For use on 1/2", 3/4" or 1" copper pipe
- Extruded holes
- CARTON QUANTITIES ONLY

PART NO.	HR #	DESCRIPTION	CTN QTY
B00006	108-20	1/2" - 1" x 20"	50
B00019	108-26	1/2" - 1" x 26"	50

Extruded Notches Copper Plated Bracket



- For use on 1/2", 3/4" or 1" copper pipe
- Extruded holes
- CARTON QUANTITIES ONLY

PART NO.	HR #	DESCRIPTION	CTN QTY
B00007	140	1/2" - 3/4" x 20"	50

Galvanized Lockright Pipe Bracket-CPVC



- For use on sinks or lavatories using CPVC
- 20 gauge galvanized steel with 1" holes on 2" centers
- Use with B00-014 and B00-015
- CARTON QUANTITIES ONLY

PART NO.	HR #	DESCRIPTION	CTN QTY
B00008	601-20	1/2" - 3/4" x 20"	50

Galvanized Lockright Bracket



- CARTON QUANTITIES ONLY

PART NO.	HR #	DESCRIPTION	CTN QTY
B00020	601-26	1/2" - 3/4" x 26"	50

Bracket for Water Closet-Copper Clad



- For use on 1/2" copper pipe
- For use with water closets or hose bibbs
- CARTON QUANTITIES ONLY

PART NO.	HR #	DESCRIPTION	CTN QTY
B00002	109-N-6	1/2"	50

Galvanized L Bracket



- For use with PEX on overhead and side runs
- Use with B00-013, B00-016, B00-017 and B00-018 inserts

PART NO.	HR #	DESCRIPTION	CTN QTY
B00009	709L	Bracket with 1 3/8" keyed holes-PEX	50

Galvanized Bracket



- For use on lavatories and toilets
- Use with B00-013, B00-016, B00-017 and B00-018 inserts

PART NO.	HR #	DESCRIPTION	CTN QTY
B00010	709	Bracket with 1 3/8" keyed holes-PEX	50

18 Gauge Galvanized Bracket-CPVC



- For use on residential toilets or hose bibbs
- Use with B00-014 or B00-015 inserts

PART NO.	HR #	DESCRIPTION	CTN QTY
B00011	609-N-6	Bracket with 1" hole	50

Turnout Bend Support for PEX



- PEX turnout bend support for potable water installations

PART NO.	HR #	DESCRIPTION	CTN QTY
B00013	704	3/8" - 1/2"	50

Insert for CPVC



- Fire retardant plastic

PART NO.	HR #	DESCRIPTION	CTN QTY
B00014	604	1/2" insert	100
B00015	605	3/4" insert	100

Metal Stud Insulator



- Fire retardant plastic
- Use for copper pipe

PART NO.	HR #	DESCRIPTION	CTN QTY
B00016	404-R	1/2" insulator	100
B00017	405-R	3/4" insulator	100
B00018	406-R	1" insulator	100

Schedule 40 Pipe Hanger



- Alternating screw and nail holes
- Load rating 250# max

Galvanized		
PART NO.	SIZE	CTN QTY
H30001	1 1/2"	50
H30002	2"	50
H30003	3"	50
H30004	4"	50

Vinyl		
PART NO.	SIZE	CTN QTY
H30011	1 1/2"	50
H30022	2"	50
H30033	3"	50
H30044	4"	50

Plastic Coated Pipe Hook



- Steel pipe hook with plastic insulation

PART NO.	SIZE	CTN QTY
H12054	1/2" x 4"	50/1000
H12056	1/2" x 6"	50/1000
H12074	3/4" x 4"	50/1000
H12076	3/4" x 6"	50/1000
H12106	1" x 6"	50/1000

"Copper Boy" Pipe Hook



• CARTON QUANTITIES ONLY

PART NO.	DESCRIPTION	CTN QTY
H10052	1/2" x 2 1/2" copper clad pipe hook	100
H10072	3/4" x 2 1/2" copper clad pipe hook	100

Drive J-Hook



• Copper clad
• CARTON QUANTITIES ONLY

PART NO.	CTS	CTN QTY
H23050	1/2" x 3/4"	100

Pipe Hook



Plain Steel



Copper Clad

• 10 gauge
• CARTON QUANTITIES ONLY

Plain Steel

PART NO.	SIZE	CTN QTY
H10054	1/2" x 4"	50/500
H10056	1/2" x 6"	50/500
H10058	1/2" x 8"	50/500
H10074	3/4" x 4"	50/500
H10076	3/4" x 6"	50/500
H10078	3/4" x 8"	50/500
H10080	3/4" x 10"	50/500
H10106	1" x 6"	50/500
H10108	1" x 8"	50/500
H10110	1" x 10"	50/500
H10126	1 1/4" x 6"	50/500
H10128	1 1/4" x 8"	50/500
H10156	1 1/2" x 6"	50/500
H10158	1 1/2" x 8"	50/500
H10208	2" x 8"	50/500

Copper Clad

PART NO.	SIZE	CTN QTY
H11054	1/2" x 4"	50/500
H11056	1 1/2" x 6"	50/500
H11058	1/2" x 8"	50/500
H11074	3/4" x 4"	50/500
H11076	3/4" x 6"	50/500
H11078	3/4" x 8"	50/500
H11080	3/4" x 10"	50/500
H11106	1" x 6"	50/500
H11108	1" x 8"	50/500
H11126	1 1/4" x 6"	50/500
H11156	1 1/2" x 6"	50/500
H11208	2" x 8"	50/500
H11210	2" x 10"	50/500

J-Hook for CTS Water System



• Nail holes on all four sides - nails are included!
• No heat distortion even at 250°
• Eliminates corrosion and electrolysis on copper pipe
• Fabricated of durable ABS plastic
• FULL BAG QUANTITIES ONLY

Baby J-Hooks

PART NO.	DESCRIPTION	BAG/CTN QTY
J01050	1/2" CTS x 4" length	25/300
J01075	3/4" CTS x 4" length	25/300
J01100	1" CTS x 4" length	25/200
J01125	1 1/4" CTS x 4" length	25/200

Long Baby J-Hooks

PART NO.	DESCRIPTION	BAG/CTN QTY
J01057	1/2" CTS x 7 1/2" length	25/200
J01077	3/4" CTS x 7 1/2" length	25/200

Double J-Hooks

PART NO.	DESCRIPTION	BAG/CTN QTY
J01051	1/2" CTS x 1/2" CTS x 4" length	25/200
J01052	1/2" CTS x 3/4" CTS x 4" length	25/200
J01053	3/4" CTS x 3/4" CTS x 4" length	25/200

J-Hook for Drain Pipe System



• Nails included
• Reduces installation time
• Glueable with universal cement
• Designed for PVC and ABS pipe
• Fabricated of durable ABS plastic
• Calibrated for 1/8" fall per foot - no more measuring & adjusting for fall
• FULL BAG QUANTITIES ONLY



PART NO.	DESCRIPTION	BAG/CTN QTY
J01150	1 1/2" DWV x 7" length	25/300
J01200	2" DWV x 7" length	25/300
J01300	3" DWV x 7" length	25/300
J01400	4" DWV x 7" length	25/300

Copper Clad Nail



• CARTON QUANTITIES ONLY

PART NO.	SIZE	CTN QTY
H15001	1 1/4"	200

Copper Coated J-Nails



• CARTON QUANTITIES ONLY

PART NO.	SIZE	CTN QTY
H22050	1/2"	100
H22075	3/4"	100

Pipe Strap



- Priced each
- CARTON QUANTITIES ONLY

Two-Hole Galvanized - IPS

PART NO.	SIZE	CTN QTY
H13038	3/8"	200
H13050	1/2"	150
H13075	3/4"	50
H13100	1"	50
H13125	1 1/4"	50
H13150	1 1/2"	25
H13200	2"	25
H13250	2 1/2"	25
H13300	3"	10
H13400	4"	10

Two-Hole Copper Clad - CTS

PART NO.	SIZE	CTN QTY
H15050	1/2"	100
H15075	3/4"	100
H15100	1"	100
H15125	1 1/4"	100
H15150	1 1/2"	100
H15200	2"	100

Two-Hole Solid Copper - CTS

PART NO.	SIZE	CTN QTY
H16038	3/8"	100
H16050	1/2"	100
H16075	3/4"	100
H16100	1"	100

One-Hole Galvanized - IPS

PART NO.	SIZE	CTN QTY
H18050	1/2"	100
H18075	3/4"	50

Full Clamp



- Plastic clamp with preloaded nail for copper, CPVC, polybutylene tubing
- CARTON QUANTITIES ONLY

PART NO.	TUBING SIZE	CTN QTY
H25050	1/2"	100
H25075	3/4"	50
H25100	1"	25

Half Clamp



- Plastic clamp with preloaded nail for copper, CPVC, polybutylene tubing
- CARTON QUANTITIES ONLY

PART NO.	TUBING SIZE	CTN QTY
H24038	3/8"	100
H24050	1/2"	50
H24075	3/4"	50
H24100	1"	50

Insulating/Suspension Clamp



- Plastic insulating and suspension clamp in one
- Eliminates noise from tubing expansion and contraction
- For copper, CPVC and polybutylene tubing
- CARTON QUANTITIES ONLY

PART NO.	TUBING SIZE	CTN QTY
H26050	1/2"	50
H26075	3/4"	50
H26100	1"	50
H26125	1 1/4"	50
H26150	1 1/2"	25
H26200	2"	25

Pipe Insulator



- Plastic insulator eliminates noise from expansion and contraction
- For copper, CPVC and polybutylene tubing
- UPC listed
- Drill hole size 1 3/8"
- CARTON QUANTITIES ONLY

PART NO.	TUBING SIZE	CTN QTY
H27050	1/2"	25
H27075	3/4"	25
H27100	1"	25

Two-Hole Pipe Clamp



- Plastic clamp eliminates noise from tubing expansion and contraction
- Supports copper, CPVC and polybutylene tubing
- CARTON QUANTITIES ONLY

PART NO.	TUBING SIZE	CTN QTY
H28050	1/2"	100
H28075	3/4"	100
H28100	1"	50
H28125	1 1/4"	50
H28150	1 1/2"	25
H28200	2"	25

F.H.A. Tub Hanger



- 12 gauge galvanized steel
- Adjustable on stud
- CARTON QUANTITIES ONLY

PART NO.	DESCRIPTION	CTN QTY
T12001	Tub Hanger	100

Metal Stud Pipe Insulator



PART NO.	SIZE	CTN QTY
H29000	3/8", 1/2", 3/4"	50
H29010	1"	50

Earthquake Strap



- Holes are spread 1" apart on center

PART NO.	SIZE	GAUGE	CTN QTY
H20500	2" x 10'	22	10

Perforated Hanger Iron



- Alternating holes (bolt and nail)
- CARTON QUANTITIES ONLY

Galvanized

PART NO.	SIZE	GAUGE	CTN QTY
H20001	3/4" x 10'	20 (heavy)	50 rolls
H20002	3/4" x 10'	24 (medium)	50 rolls
H20003	3/4" x 10'	28 (light)	50 rolls
H20005	3/4" x 50'	20 (heavy)	10 rolls
H20006	3/4" x 50'	24 (medium)	10 rolls
H20007	3/4" x 50'	28 (light)	10 rolls
H20010	3/4" x 100'	20 (heavy)	5 rolls
H20011	3/4" x 100'	24 (medium)	10 rolls
H20012	3/4" x 100'	28 (light)	10 rolls

Copper Clad

PART NO.	SIZE	GAUGE	CTN QTY
H20100	3/4" x 10'	22 (heavy)	50 rolls
H20150	3/4" x 50'	22	10 rolls

Plastic Hanger Tape



- Flexible, non-conductive polypropylene
- 3/4" wide, .050 thick
- 1/8" diameter holes every 3/4"
- 125 lb. ultimate load ASTM A-370-77
- Can be cut with scissors or utility knife
- Uses: pipe hanger, duct hanger and tubing utility strapping

PART NO.	DESCRIPTION	CTN QTY
H21010	10' roll poly bagged	100
H21025	25' roll poly bagged	40
H21050	50' roll poly bagged	25
H21100	100' roll poly bagged	10
H21101	100' roll dispenser box	10

Plastic Hanger Tape



- 125# max load
- 1/8" diameter holes every 3/4"
- 2" wide; .05 thickness; cuts with scissors

PART NO.	SIZE	CTN QTY
H21200	2" x 100'	10

Mason's Nylon Twine



- Approximately 165 lb. break strength
- Twisted yellow twine

PART NO.	DESCRIPTION	CTN QTY
T60001	#18 x 225'	12
T60000	#18 x 1100'	1

Binder Sisal Twine



- Used to tie down material for hauling

PART NO.	DESCRIPTION	CTN QTY
T60002	5 lb. bale (approx. 2500')	10

Candle Wick Packing



- Medium packing in 2 ounce balls

PART NO.	DESCRIPTION	CTN QTY
T60003	Candle wick packing	40

Graphite Packing



- Non-asbestos material in resealable spoos

PART NO.	DESCRIPTION	CTN QTY
T60005	1/8" diameter x 12' spool	10
T60006	1/4" diameter x 8' spool	10

Oakum



- The original Oakum with benonite-expands over 10 times when wet
- Baled in coils or cut length for easy use
- No tar in brown oakum
- CARTON QUANTITIES ONLY (except 1 lb. bags)

PART NO.	DESCRIPTION	INNER PACK	CTN QTY
O15001	Brown random cut	10 - 5 lb. bags	1
O15002	White 3/8" cord	6 - 10 lb. coils	1
O15003	White 3/8" cord (27" cut length)	10 - 5 lb. bags	1
O15006	Brown random cut	1 lb. bags	25
O15007	White 3/8" cord (27" cut length)	1 lb. bags	25

Lead Wool



- Five pound box

PART NO.	SIZE	CTN QTY
L40001	5 pounds	10

Lead Ingot



L42002



L42052

PART NO.	SIZE	CTN QTY
L40002	25 pounds (Handle w/ four 5 lb. plugs)	1
L42052	5 pounds	1

Lead Melting Pot



- Wire handle

PART NO.	SIZE	CTN QTY
L42006	6" pot	2
L42008	8" pot	1

Lead Pouring Ladle



- Wrought steel

PART NO.	SIZE	CTN QTY
L42102	3" ladle	5
L42103	3 1/2" ladle	5
L42104	4" ladle	5

Drum Trap Cover



- Flanged, plated die cast
- Cover supplied with gasket
- D02-002 CARTON QUANTITIES ONLY

PART NO.	DESCRIPTION	CTN QTY
D02001	Cover and gasket	25
D02002	Gasket only	25
P55300	Rough brass cover	10

Trap Covers



C98001



C98002

- Stainless steel

PART NO.	DESCRIPTION	CTN QTY
C98001	5 3/4" flat SS trap cover	1
C98002	5 3/4" raised SS trap cover	1

Wet-R-Dri Roofing Cement



- All-weather plastic
- Chemically fortified to bond to water-covered, damp or dry surfaces
- Great for emergency repairs under wet conditions

PART NO.	DESCRIPTION	CTN QTY
C09000	5 gallon can	1
C09001	One gallon can	6
C09002	10.5 ounce cartridge	12

Foundation and Roof Coating



- Non-fibered liquid damp-proof seal
- All weather plastic
- Chemically fortified to bond to water covered, damp or dry surfaces
- Great for emergency repairs under wet conditions

PART NO.	DESCRIPTION	CTN QTY
C09003	1 Gal. Foundation and Roof Coating	6

Sewage Ejector/Sump Pump Check Valve



- Couplings are sized for IPS ID hose
- Combination unit for 1 1/2" and 1 1/4" IPS, 1 1/2" copper

PART NO.	DESCRIPTION	CTN QTY
C29150	1 1/2" slip x 1 1/2" slip	24
C29200	2" slip x 2" slip	12
C29126	1 1/4" slip x 1 1/2" slip	24

Flexible Discharge Hose



- Ideal for sump pumps, centrifugal pumps, and submersible pumps
- Complete kit includes 24' hose, 1 1/4" adapter and steel clamp

PART NO.	DESCRIPTION	CTN QTY
C29123	1 1/2" Flex Discharge Hose Kit	10
C29124	1 1/4" Complete Kit	10

Roofite® Hi-Heat Silicone Flashing



- Silicone range is designed for high temperature applications up to 390°F
- Ideal for corrugated metal roofs
- Can be used on flat roofs
- Pipe diameter markings
- For plumbing, heating, air conditioning, electrical or exhaust vents
- Pleated cone adjusts to any pitch up to 45° F
- Ozone and UV resistant

PART NO.	SIZE	CTN QTY
R16100	0"-2 3/4"	1
R16101	2"-6 1/8"	1
R16107	6"-10 1/32"	1
R16108	9 1/2"-14 3/4"	1

Roofrite® Roof Flashing



- Ideal for corrugated metal roofs
- Can be used on flat roofs
- Pipe diameter markings
- For plumbing, heating, air conditioning, electrical or exhaust vents
- Made of EPDM with flexible aluminum base
- Pleated cone adjusts to any pitch
- -30°F to +250°F
- Ozone and UV resistant

PART NO.	SIZE	CTN QTY
R15109	0"-1 1/4"	1
R15100	0"-2 3/4" pipe	1
R15101	2"-6 1/8" pipe	1
R15107	6"-10 1/32" pipe	1
R15108	9 1/2"-14 3/4" pipe	1

Galvanized Roof Flashing



- Double seal neoprene collar
- UPC, BOCA ad SBCCI approved

PART NO.	SIZE	FLANGE	CTN QTY
R40150	1 1/4" and 1 1/2"	8 3/4" x 12 1/2"	20
R40200	2"	8 3/4" x 12 1/2"	20
R40300	3"	10 3/4" x 14 1/2"	20
R40400	4"	12" x 16"	20

Aluminum Roof Flashing



- Double seal neoprene collar

PART NO.	SIZE	FLANGE	CTN QTY
R45150	1 1/4" and 1 1/2"	8 3/4" x 12 1/2"	12
R45200	2"	8 3/4" x 12 1/2"	20
R45300	3"	10 3/4" x 14 1/2"	20
R45400	4"	12" x 16"	20

All Neoprene Roof Flashing



- Double seal neoprene collar

PART NO.	SIZE	FLANGE	CTN QTY
R50150	1 1/4" and 1 1/2"	9" x 11 3/8"	20
R50200	2"	9" x 11 3/8"	20
R50300	3"	10" x 13 1/4"	20
R50400	4"	12" x 14 3/4"	20

Neo-poly Roof Flashing



- Poly vinyl base
- Neoprene collar

PART NO.	SIZE	FLANGE	CTN QTY
R57150	1 1/4" and 1 1/2"	9 1/4" x 13"	20
R57200	2"	9 1/4" x 13"	20
R57300	3"	11 1/8" x 15"	20
R57400	4"	12" x 15 1/2"	20

Lead Roof Flashing



- Southeastern Code
- 2 1/2 pounds
- Multi-pitch from flat to 7/12"
- CARTON QUANTITIES ONLY

PART NO.	SIZE	FLANGE	CTN QTY
R70150	1 1/2"	8 1/2" x 10 1/2"	12
R70200	2"	8 1/2" x 10 1/2"	12
R70300	3"	10 1/2" x 11 1/2"	6
R70400	4"	10 1/2" x 11 1/4"	6

Instant Sealant



- Flame resistant
- Fills holes and cracks
- Deadens sound
- Insulates against air conditioning and heat loss
- Prevents passage of dirt, water and insects
- Both 12 and 24 oz. cans spray in any position
- UPS GROUND AND MOTOR FREIGHT ONLY
- CARTON QUANTITIES ONLY

PART NO.	DESCRIPTION	CTN QTY
S30012	12 oz. cans	12
S30024	24 oz. cans	12

Hose and Hose Bracket for Service Sink



- Heavy duty 300 cloth-reinforced 5/8" rubber hose (2 1/2" long)
- 3/4" brass hose coupling at one end
- 5" x 3" stainless steel bracket with rubber grip

PART NO.	DESCRIPTION	CTN QTY
M05001	Hose with bracket	1/5
M05005	Bracket only	1

Mop Hanger for Service Sink



- 24" x 3" stainless steel hanger with three rubber tool grips
- Anchors included

PART NO.	DESCRIPTION	CTN QTY
M05003	Mop hanger	1/5

Anchor Bolt Kit



• Includes anchors, hex head screws and drill bit

PART NO.	SIZE	PIECES	DRILL BIT	CTN QTY
A33001	#8 x 1"	100	3/16"	5
A33002	#10 x 1 1/4"	100	1/4"	5
A33005	#14 x 1 1/2"	50	5/16"	5

Stove Bolt with Nut



• Zinc plated
• CARTON QUANTITIES ONLY

PART NO.	SIZE	CTN QTY
F33009	3/16" x 3/4"	100
F33010	1/4" x 3/4"	100
F33011	1/4" x 1"	100
F33012	1/4" x 1 1/4"	100
F33013	1/4" x 1 1/2"	100
F33014	1/4" x 2"	100

Flat Phillips Head Brass Wood Screw



• Flat Phillips head
• Solid brass construction
• CARTON QUANTITIES ONLY

PART NO.	SIZE	CTN QTY
F33300	#12 x 1 1/4"	100
F33301	#12 x 1 1/2"	100
F33302	#12 x 2"	100
F33303	#14 x 1 1/4"	100

Phillips Head Wood Screw



• Zinc plated
• CARTON QUANTITIES ONLY

PART NO.	SIZE	CTN QTY
F33030	#10 x 1 1/2"	100
F33031	#12 x 1"	100
F33032	#12 x 1 1/4"	100
F33033	#12 x 1 1/2"	100
F33034	#12 x 2"	100
F33035	#12 x 2 1/2"	100
F33036	#12 x 3"	100
F33037	#14 x 1 1/4"	100
F33038	#14 x 1 1/2"	100
F33039	#14 x 2"	100
F33040	#14 x 2 1/2"	100
F33041	#14 x 3"	100

Hex Head Lag Screw



• CARTON QUANTITIES ONLY

PART NO.	SIZE	CTN QTY
F33140	3/8" x 1"	100
F33141	3/8" x 1 1/2"	100
F33142	3/8" x 2"	100
F33143	3/8" x 2 1/2"	50
F33144	3/8" x 3"	50

E-Z Anchor/Self-Drilling Wall Board



• Die cast zinc
• Installs with #2 Phillips screwdriver
• CARTON QUANTITIES ONLY

PART NO.	DESCRIPTION	CTN QTY
A33010	E-Z Anchor with 1 1/4" screws	10

Toggle Bolt



Toggle Bolt



Toggle Wing

• Zinc plated
• Spring loaded wing
• CARTON QUANTITIES ONLY

PART NO.	SIZE	CTN QTY
F33060	3/16" x 3/4"	50
F33061	1/4" x 3"	50
F33062	1/4" x 4"	50
F33063	1/4" x 6"	50
F33064	3/8" x 4"	50
F33065	3/8" x 6"	50

Toggle Wing Only

PART NO.	SIZE	CTN QTY
F33066	3/16"	100
F33067	1/4"	100
F33068	3/8"	100
F33069	1/2"	100

Hex Head Tapping Screw



• Zinc plated
• CARTON QUANTITIES ONLY

PART NO.	SIZE	CTN QTY
F33101	#7 x 1/2"	100
F33102	#7 x 1/2"	1000
F33103	#8 x 1/2"	100
F33104	#8 x 1/2"	1000
F33105	#8 x 3/4"	100
F33106	#8 x 3/4"	1000
F33107	#8 x 1"	100
F33108	#8 x 1"	500
F33109	#8 x 1 1/2"	50
F33110	#8 x 1 1/2"	500
F33111	#8 x 2"	50
F33112	#8 x 2"	250
F33113	#10 x 3/4"	100
F33114	#10 x 3/4"	1000
F33115	#10 x 1"	100
F33116	#10 x 1"	500

Drill Point Tech Screw



• CARTON QUANTITIES ONLY

PART NO.	SIZE	CTN QTY
F33120	#8 x 1/2"	100
F33121	#8 x 1/2"	500
F33122	#8 x 3/4"	100
F33123	#8 x 3/4"	500
F33124	#10 x 3/4"	100
F33125	#10 x 3/4"	500
F33126	#10 x 1"	100
F33127	#10 x 1"	500
F33128	#10 x 1 1/2"	100
F33129	#12 x 3/4"	100
F33130	#12 x 1"	100
F33131	#12 x 1 1/2"	100
F33132	#12 x 2"	100

Hex Nut



• Zinc plated
• CARTON QUANTITIES ONLY

PART NO.	SIZE	CTN QTY
F33080	1/4" - 20	100
F33081	5/16" - 18	100
F33082	3/8" - 16	100
F33083	1/2" - 13	50

Zinc Plated Fender Washer



• CARTON QUANTITIES ONLY

PART NO.	SIZE	OD	CTN QTY
F33098	1/4"	1 1/2"	100
F33096	3/8"	1 1/2"	100
F33097	1/2"	2"	100

Flat Washer



• Zinc plated
• CARTON QUANTITIES ONLY

PART NO.	SIZE	OD	CTN QTY
F33094	3/8"	1"	100
F33095	1/2"	1 3/8"	100

Carrier Nuts and Washer Set



• 4 nuts and washers
• 5/8 - 11 threads
• Much lower cost than specification companies

PART NO.	DESCRIPTION	CTN QTY
C56100	Carrier nuts and washer set (4-pack)	10

Universal Beam Clamp



• 3/8" UNC bolt thread
• Steel set screw

PART NO.	SIZE	ROD SIZE	CTN QTY
H60375	3/8"	3/8"	25
H60050	1/2"	1/2"	25
H60625	5/8"	5/8"	25
H60075	3/4"	3/4"	25

Purin Clamp



• 3/8" UNC bolt thread
• Steel set screw

PART NO.	SIZE	ROD SIZE	CTN QTY
H61375	3/8"	3/8"	25

Copper Pipe Hangers - Bell & Milford Types



Bell Type



Milford Type

• Copper clad

Bell Type		
PART NO.	SIZE	CTN QTY
H83050	1/2"	25
H83075	3/4"	25
H83100	1"	25

Milford Type		
PART NO.	SIZE	CTN QTY
H84050	1/2" x 6"	25
H84075	3/4" x 6"	25
H84100	1" x 6"	25
H85050	1/2" x 12"	25
H85075	3/4" x 12"	25
H85100	1" x 12"	25

Conduit Hangers



- Packed with bolts and nuts
- CARTON QUANTITIES ONLY

Zinc Plated

PART NO.	CODE NO.	RIGID	THIN WALL	CTN QTY
H14050	0	1/2"-3/8"	1/2"	100
H14075	1	3/4"	3/4"	50
H14100	2	1"	1"	50
H14125	3	1 1/4"	-	50
H14150	4	1 1/2"	1 1/2"	25
H14200	5	2"	2"	25
H14250	6	2 1/2"	-	10
H14300	7	3"	-	10
H14350	8	3 1/2"	-	10
H14400	9	4"	-	10

Copper Plated

PART NO.	CODE NO.	RIGID	THIN WALL	CTN QTY
H17050	0	1/2"-3/8"	1/2"	100
H17075	1	3/4"	3/4"	100
H17100	2	1"	1"	50
H17125	3	1 1/4"	-	50
H17150	4	1 1/2"	1 1/2"	25
H17200	5	2"	2"	25
H17250	6	2 1/2"	-	25
H17300	7	3"	-	25
H17350	8	3 1/2"	-	25
H17400	9	4"	-	25

Swivel Ring



- Supplied with nuts

Zinc Plated

PART NO.	SIZE	ROD SIZE	CTN QTY
H65050	1/2"	3/8"	25
H65075	3/4"	3/8"	25
H65100	1"	3/8"	25
H65125	1 1/4"	3/8"	25
H65150	1 1/2"	3/8"	25
H65200	2"	1/2"	20
H65250	2 1/2"	1/2"	20
H65300	3"	1/2"	10
H65400	4"	1/2"	10
H65500	5"	1/2"	5
H65600	6"	1/2"	5

Copper Plated

PART NO.	SIZE	ROD SIZE	CTN QTY
H66050	1/2"	3/8"	25
H66075	3/4"	3/8"	25
H66100	1"	3/8"	25
H66125	1 1/4"	3/8"	25
H66150	1 1/2"	3/8"	25
H66200	2"	1/2"	20
H66250	2 1/2"	1/2"	20
H66300	3"	1/2"	10
H66400	4"	1/2"	10

Zinc Plated Clevis Hanger



Standard - 401# Steel

PART NO.	SIZE	ROD SIZE	CTN QTY
H68050	1/2"	3/8"	25
H68075	3/4"	3/8"	25
H68100	1"	3/8"	25
H68125	1 1/4"	3/8"	25
H68150	1 1/2"	3/8"	25
H68200	2"	3/8"	20
H68250	2 1/2"	1/2"	20
H68300	3"	1/2"	10
H68350	3 1/2"	1/2"	10
H68400	4"	5/8"	10
H68500	5"	5/8"	5
H68600	6"	3/4"	5
H68800	8"	7/8"	5

Light Duty - 400# Steel

PART NO.	SIZE	ROD SIZE	CTN QTY
H69050	1/2"	3/8"	25
H69075	3/4"	3/8"	25
H69100	1"	3/8"	25
H69150	1 1/2"	3/8"	25
H69200	2"	3/8"	20
H69250	2 1/2"	1/2"	20
H69300	3"	1/2"	10
H69400	4"	5/8"	10

Riser Clamp



- For Schedule 40 iron pipe only - Not for soil pipe

PART NO.	SIZE	OVERALL WIDTH	CTN QTY
H70050	1/2"	9 3/8"	25
H70075	3/4"	9 3/8"	25
H70100	1"	9 3/8"	25
H70125	1 1/4"	10"	25
H70150	1 1/2"	10 3/8"	25
H70200	2"	10 7/8"	25
H70250	2 1/2"	11 1/4"	25
H70300	3"	11 3/4"	10
H70350	3 1/2"	13 1/4"	10
H70400	4"	13 1/2"	10

Hinged Split Ring



Zinc Plated for Iron Pipe

PART NO.	SIZE	ROD SIZE	CTN QTY
H72375	3/8"	3/8"	25
H72050	1/2"	3/8"	25
H72075	3/4"	3/8"	25
H72100	1"	3/8"	25
H72125	1 1/4"	3/8"	25
H72150	1 1/2"	3/8"	25
H72200	2"	3/8"	20
H72250	2 1/2"	1/2"	20
H72300	3"	1/2"	10
H72400	4"	1/2"	10

Copper Plated for Copper Tube

PART NO.	SIZE	ROD SIZE	CTN QTY
H73375	3/8"	3/8"	25
H73050	1/2"	3/8"	25
H73075	3/4"	3/8"	25
H73100	1"	3/8"	25
H73125	1 1/4"	3/8"	25
H73150	1 1/2"	3/8"	25
H73200	2"	3/8"	10

Ceiling Flange

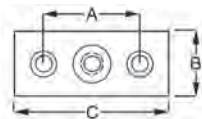

DIMENSIONS		
A	B	C
2"	1 3/8"	2 3/4"

PART NO.	SIZE	CTN QTY
H80375	3/8" plain finish	25
H80050	1/2" plain finish	25
H81375	3/8" zinc finish	25
H81050	1/2" zinc finish	25
H82375	3/8" copper finish	25
H82050	1/2" copper finish	25

Threaded Steel Rod



- Priced per rod
- CARTON QUANTITIES ONLY

PART NO.	DESCRIPTION	CTN QTY
T38006	3/8" x 6' plain finish	25
T38010	3/8" x 10' plain finish	25
T12006	1/2" x 6' plain finish	12
T12010	1/2" x 10' plain finish	12
T38106	3/8" x 6' zinc finish	25
T38110	3/8" x 10' zinc finish	25
T12106	1/2" x 6' zinc finish	12
T12110	1/2" x 10' zinc finish	12

Drop-In Concrete Anchor



- Priced per rod
- CARTON QUANTITIES ONLY

PART NO.	DESCRIPTION	CTN QTY
T38038	3/8" Drop-In Anchor	100
T12050	1/2" Drop-In Anchor	100

Rod Coupling Nut



- Hex, zinc plated, carbon steel

PART NO.	DESCRIPTION	CTN QTY
R60001	1/4" x 7/8"	50
R60002	3/8" x 1 3/4"	50
R60003	1/2" x 1 3/4"	50
R60004	5/8" x 2 1/8"	50

Water Meter Box Keys and Covers



M07001



M07002



M25900

- All brass



M25900 bottom view

PART NO.	DESCRIPTION	CTN QTY
M07001	Meter box key	50
M07002	Combination key and wrench	50
M25900	Penta head meter box and roadway box wrench	15

Water Meter Coupling Complete



- Heavy cast brass
- Complete with gasket
- LEAD FREE

PART NO.	SIZE	NPSM	LENGTH	NPT	CTN QTY
M20058	1/2"	3/4"	2 3/8"	1/2"	10
M20075	3/4"	1"	2 1/2"	3/4"	10
M20100	1"	1 1/4"	2 5/8"	1"	1

Gasket Only for Water Meter Couplings



- CARTON QUANTITIES ONLY

PART NO.	DESCRIPTION	CTN QTY
M20581	5/8" gasket for coupling	25
M20751	3/4" gasket for coupling	25
M20101	1" gasket for coupling	25

10" Economy Meter Box

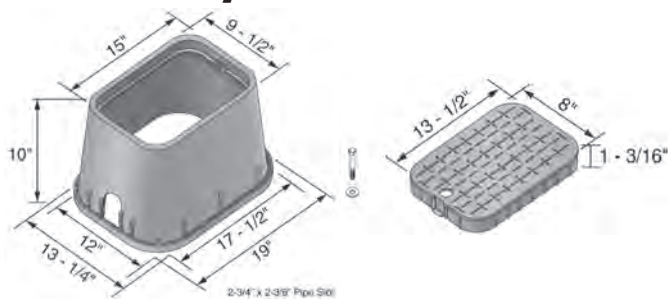

- Snap-in green lid
- 96 per pallet

PART NO.	DESCRIPTION	CTN QTY
M06001	10" rectangular box and lid	96
M06002	10" green snap-in lid only	1

Note: All items shown are for non-vehicular applications. Concrete and asphalt installations are not recommended for plastic parts.

12" Water Meter Box

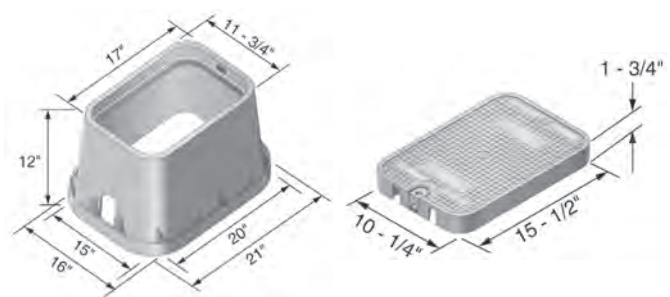

PART NO.	DESCRIPTION	CTN QTY
M12001	12" box and solid green lid	72
M12002	12" box and black reader lid	72
M12022	12" box and lid marked "sewer"	72
M12003	6" extension	42
M12005	12" solid green lid only	1
M12006	12" black reader lid only	1
M12009	12" box and solid black lid	72

Note: All items shown are for non-vehicular applications. Concrete and asphalt installations are not recommended for plastic parts.

12" Water Meter Box with Solid Cast Iron Lid

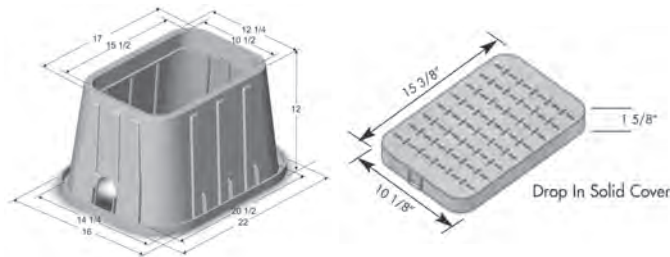

PART NO.	DESCRIPTION	CTN QTY
M12100	12" box with cast iron lid	1
M12085	Cast iron cover only	1

Note: All items shown are for non-vehicular applications. Concrete and asphalt installations are not recommended for plastic parts.

12" Standard Meter Box with Plastic Lid and Cast Iron Reader

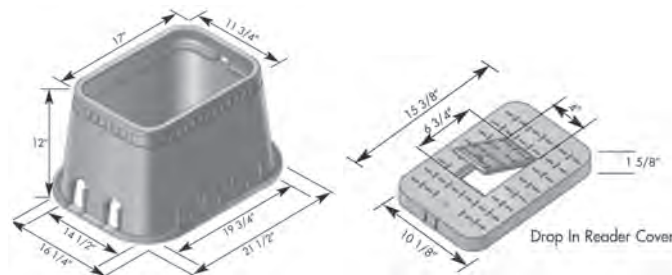

- 72 per pallet

PART NO.	DESCRIPTION	CTN QTY
M12004	12" box with CI lid	1

Note: All items shown are for non-vehicular applications. Concrete and asphalt installations are not recommended for plastic parts.

12" Irrigation Box (6" Deep)

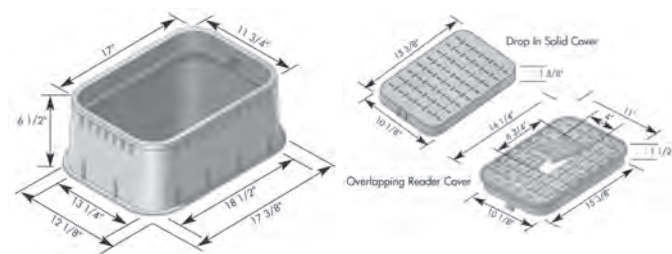

PART NO.	DESCRIPTION	CTN QTY
M12007	6" depth with green lid	1
M12005	12" solid green lid only	1
M12006	12" black reader lid only	1
M12008	12" valve box 6" deep with reader lid	1

Note: All items shown are for non-vehicular applications. Concrete and asphalt installations are not recommended for plastic parts.

15" Jumbo Water Meter Boxes

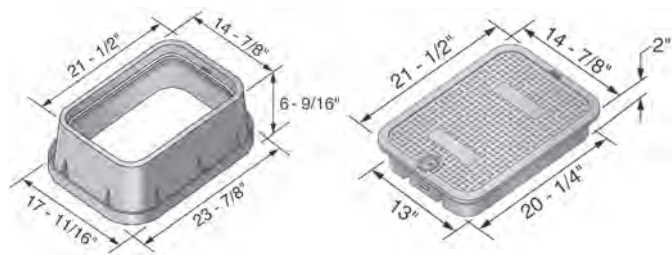

PART NO.	DESCRIPTION	CTN QTY
M15001	15" box and green solid lid	48
M15009	6" extension for M15001	36
M15002	15" box and black reader lid	48
M15004	15" solid green lid only	1
M15005	15" black reader lid only	1
M15006	6" extension with solid green lid	1

Note: All items shown are for non-vehicular applications. Concrete and asphalt installations are not recommended for plastic parts.

6" Residential Valve Boxes

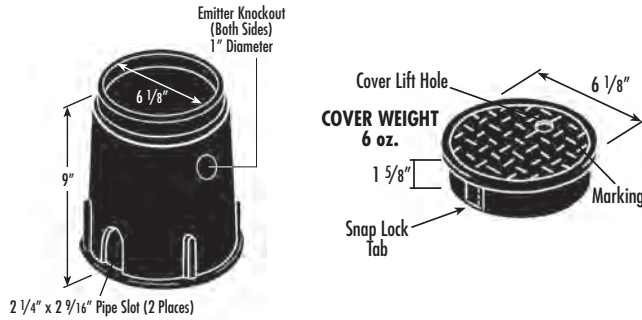

- Snap-in green lid
- Overlapping cover keeps dirt or grass from between body and lid
- Valve box can be extended with any 6" plastic or iron pipe
- 36 per carton

PART NO.	DESCRIPTION	CTN QTY
M06006	6" valve box 9" tall	36
M06007	6" green snap-in lid only	1

Note: All items shown are for non-vehicular applications. Concrete and asphalt installations are not recommended for plastic parts.

10" Round Valve Boxes

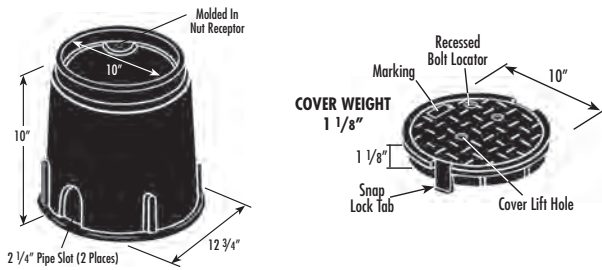

- Snap-in green lid
- Overlapping cover keeps dirt or grass from between body and lid
- 99 per pallet

PART NO.	DESCRIPTION	CTN QTY
M06010	10" round body and green lid	180
M06003	10" green round lid only	1

Note: All items shown are for non-vehicular applications. Concrete and asphalt installations are not recommended for plastic parts.

Shipping Boxes



- 32 ECT board test
- Kraft (brown)
- 200 pound burst strength
- BUNDLE QUANTITIES ONLY

PART NO.	SIZE	CTN QTY
BOX012	12 3/4"L x 12 3/4"W x 13 1/2"D	20
BOX011	11 1/8"L x 11 1/8"W x 9 1/8"D	20
BOX008	8"L x 8"W x 8"D	20
BOX006	6"L x 6"W x 8"D	20

Bin Boxes



PART NO.	SIZE	CTN QTY
BIN004	4"L x 12"W x 6 5/8"D	20
BIN005	5 1/4"L x 11 3/4"W x 6"D	20
BIN008	8"L x 12 1/4"W x 7 1/2"D	20
BIN012	12"L x 12 3/8"W x 7 1/2"D	20

Plastic Tub Box



PART NO.	SIZE	CTN QTY
T40001	13"L x 13"W x 7"D	20
T40002	12"L x 8 1/8"W x 6 1/2"D	20

Cardboard Tub Box



PART NO.	SIZE	CTN QTY
T40003	12"L x 8"W x 8 1/2"D wax coated	25
T40004	14 1/2"L x 11 5/16"W x 6"D wax coated	25
T40005	15"L x 12"W x 9"D	1
T40007	12"L x 12"W x 9"D	1
T40008	12"L x 12"W x 12"D non-coated	

A
 Access Panel 1
 Plastic 1
 Snap-Ease 1
 Anchor Bolt Kit 32

B
 Bathroom Fan Vent Kit 8
 Bore O-Ring 5
 Boxes 37
 Bin 37
 Cardboard Tub 37
 Plastic Tub 37
 Shipping 37

Bracket
 Carrier 25
 Extruded Hole Copper Plated 25
 Extruded Notches Copper Plated 25
 Flat Copper Plated 25
 Galvanized 25, 26
 Galvanized-CPVC 26
 Galvanized L 26
 Galvanized Lockright 26
 Galvanized Lockright Pipe-CPVC 26
 Holdrite 25
 Water Closet-Copper Clad 26

Brass Wells 23
 Bushing for Qwik Tees and Qwik Elbows 5

C
 Carrier Nuts and Washer Set 33
 Ceiling Flange 35
 Compression Coupling 1
 Bronze 1
 CPVC 2
 Malleable Iron 1
 PVC 2
 Compression Tee 2
 Malleable Iron 2
 PVC 2
 Conduit Hangers 34
 Copper Pipe Hangers - Bell & Milford Types 33

D
 Dielectric Union 18
 Flanged 18
 Gasket and Insert 19
 Dishwasher Repair 6
 Dishwasher Drain Connector 6
 Dishwasher Hose 6
 Drain King 4
 Drop-In Concrete Anchor 35
 Dryer Repair 7
 Aluminum Ducting 8
 Flexible Aluminum 8
 Flexible Aluminum Foil 8
 Proflex Aluminum Foil 8
 Aluminum Elbow and Pipe 8
 Flexible Duct Connector Kit 8
 Increaser/Decreaser 8
 Pan 7
 Washer/Dryer Combo 7
 Vent 7

Aluminum Hood 7
 Clamp for Dryer Vent Kit 8
 Complete Dryer Vent Kit 7
 Dryer Vent Hood 7
 Dryer Vent Hose 8
 Dryer Vent Kit w/Louvered Hood 8
 Indoor Dryer Vent Kit 8
 Louvered Dryer Vent Hood 7
 Metal Clamp for Dryer Vent 8
 White Back Collar for Dryer Vent Kits 7

E
 Earthquake Strap 29
 Expansion Coupling 2
 PVC Expansion Coupling 2
 Extension Hose 4
 E-Z Anchor/Self-Drilling Wall Board 32

F
 F.H.A. Strap 24
 Galvanized Steel 24
 F.H.A. Tub Hanger 28
 Flexible Discharge Hose 30
 Flexible Drain Trap 6
 Flexible PVC Saddle Fitting 5
 Flexible Transition Coupling 5
 Flexible Trap Drain Connector 5
 Foundation and Roof Coating 30
 Full Clamp 28

H
 Half Clamp 28
 Hex Nut 33
 Hinged Split Ring 35
 Hose Grip Clothes Washer Connector 6

I
 Icemaker Boxes 6
 With Hammer Arrester 6
 With Valves 6
 Insert for CPVC 26
 Instant Sealant 31
 Insulating/Suspension Clamp 28
 Insulation Contact Adhesive 18
 Insulation Protective Coating 18

J
 J-Hook 27
 Drive 27
 For CTS Water System 27
 For Drain Pipe System 27

L
 LACO 9
 Slic-tite® High Density Thread Sealants 9
 Lead Ingot 30
 Lead Melting Pot 30
 Lead Pouring Ladle 30
 Lead Wool 29

M
 Metal Stud Insulator 26
 Metal Stud Pipe Insulator 28
 Mixer Hose 7
 Mop Hanger for Service Sink 31

N
 Nails 27

Copper Clad Nail.....	27	Tridicator	22
Copper Coated J-Nails.....	27	Vacuum Gauge.....	22
Needle Valve for Pressure Gauge.....	22	Water Test Gauge	21
O		Pressure Snubber.....	22
Oakum.....	29	Primer for Pipe Wrap Tape.....	9
P		PTFE Thread Seal Tape	9
Packing.....	29	Purin Clamp	33
Candle Wick	29	Q	
Graphite.....	29	Qwik Elbow	5
Perforated Hanger Iron.....	29	Qwik Tee.....	5
Pigtail Syphon	21	R	
Pipe Bracket		Repair Clamp.....	1
Carrier.....	25	Stainless Steel	1
Extruded Hole Copper Plated	25	Riser Clamp.....	34
Extruded Notches Copper Plated.....	25	Rod Coupling Nut.....	35
Flat Copper Plated	25	Roof Flashing	31
For Water Closet-Copper Clad.....	26	All Neoprene.....	31
Galvanized	25	Aluminum.....	31
Galvanized-CPVC	26	Galvanized	31
Galvanized L.....	26	Lead.....	31
Galvanized Lockright	26	Neo-poly	31
Galvanized Lockright-CPVC	26	Roofrite.....	31
Holdrite.....	25	Roofrite Hi-Heat Silicone	30
Pipe Hanger	26	Run-Off Tube.....	20
Schedule 40.....	26	S	
Pipe Hook	26	Sand Cloth.....	10
“Copper Boy”	27	Flexible Open Mesh	10
Plastic Coated	26	Open Mesh.....	10
Pipe Insulation		Waterproof Aluminum Oxide.....	10
Double Stick	17	Water Resistant.....	10
Insulation Contact Adhesive.....	18	Screws.....	32
Insulation Protective Coating	18	Drill Point Tech Screw	33
Insulation Tape.....	18	Flat Phillips Head Brass Wood Screw	32
Poly		Hex Head Lag Screw	32
Double Stick Pipe Insulation	17	Hex Head Tapping Screw	32
Semi-Slit Pipe Insulation	17	Phillips Head Wood Screw.....	32
Rubber.....	14	Service Sink Repair.....	31
Double Stick Rubber Pipe Insulation	14	Hose and Hose Bracket	31
Seamless Rubber Pipe Insulation	13	Mop Hanger	31
Semi-Slit	17	Sewage Ejector/Sump Pump Check Valve.....	30
Pipe Insulator.....	28	Slip-On Plastic Cap	3
Metal Stud	28	Stove Bolt with Nut	32
Pipe Sleeving.....	10	Stretch Wrap	10
Pipe Strap	28	Film and Dispenser	10
Plastic Hanger Tape	29	Stud Guard.....	24
Plumbjet	4	Interlocking	24
Plunger.....	4	Stud Protectors and Plate	24
Force Cup.....	4	Stud Shoe.....	24
Professional Force Cup Display.....	5	Swivel Ring.....	34
Pressure Gauges.....	22	T	
Gas	21	Tape.....	9
Gas Test Assembly	22	Box Sealing.....	9
Gas Test Gauge	21	Duct	9
Gas Test Gauge Assembly.....	22	Electrical	9
Gas Testing Equipment	20	Insulation	18
Liquid Filled	21	Pipe Wrap	9
Needle Valve.....	22	Domestic Pipe Wrap Tape	9
Pressure Gauge.....	21	Imported Pipe Wrap Tape	9
Sillcock/Water or Gas Test Gauge Assembly	21	Primer for Pipe Wrap Tape.....	9
Test Gauge Assembly.....	21	Self-Fusing	9

Thread Seal
 PTFE Thread Seal Tape 9
 PTFE Yellow Gas Line Thread Seal Tape 9
 Slic-tite® High Density Thread Sealants 9
 Thread Seal Tape Jar Display 9
T-Cone Cleanout Repair Plugs 3
Tee Plug 4
 Inflatable 4
Test Cap 3
 Flexible PVC 3
 Knockout 4
 PVC Dual Fit 3
 PVC Test Cap 3
 Slip-On Plastic 3
 Techno Test Plug 3
Test Plug 2, 3
 Cast Iron 3
 Combination 3
 Economy 2
 "Plum-Tite" Mechanical 3
 Pneumatic 4
 Pneumatic-Hydraulic 4
 Two Stage Long 4
Thermal Expansion Tank 18
Thermometer 22
 Bi-Metal Dial 23
 Brass Wells 23
 Dial 22
 Hot Water/Refrigerant Line 22
 Pocket Test 23
 Weksler Industrial Multi-Angle 22
Threaded Steel Rod 35
Thread Sealants, Slic-tite® High Density 9
Toggle Bolt 32
Trap Cover 30
 Drum 30
Tubing 23
 Clear Vinyl 23
 Natural Polyethylene 23
 Soft Aluminum 23
Turnout Bend Support for PEX 26
Twine 29
 Binder Sisal 29
 Mason's Nylon 29
Two-Hole Pipe Clamp 28

U

Universal Beam Clamp 33
Universal Copper Thermocouple 19

W

Washers 33
 Flat 33
 Zinc Plated Fender 33
Washing Machine Repair 6
 Boxes 6
 with Hammer Arrester 6
 with Valves 6
 Hoses 7
 Drain 7
 Fit-All Drain 7
 Mixer 7

Washing Machine 6
 Pan 7
 Washer/Dryer Combo 7
 Washing Machine 7
Water Heater Repair 19
 Connector 19
 Stainless Steel Water Heater 19
 Water Heater 19
 Pan 20
 Adapter 20
 Galvanized 20
 Safety 20
 Water Heater 20
 Stand 20
 Stand-rite 20
 Water Heater Stand 20
Water Meter Repair 35
 Gasket Only for Water Meter Couplings 35
 Water Meter Box Keys and Covers 35
 Water Meter Coupling Complete 35
Wet-R-Dri Roofing Cement 30
Z
Zinc Plated Clevis Hanger 34

PART NO.	PG #	PART NO.	PG #	PART NO.	PG #	PART NO.	PG #
A04006	1	BOX011	37	C17100	2	D04023	7
A04012	1	BOX012	37	C17125	2	D04024	7
A05008	1	C09000	30	C17150	2	D04025	7
A05014	1	C09001	30	C17200	2	D04026	7
A05027	1	C09002	30	C19050	2	D04027	8
A33001	32	C09003	30	C19051	2	D04028	8
A33002	32	C10050	1	C19075	2	D04031	8
A33005	32	C10075	1	C25000	10	D04032	8
A33010	32	C10100	1	C25001	10	D04033	8
B00001	25	C11050	1	C25002	10	D04034	8
B00002	26	C11075	1	C25003	10	D04035	8
B00003	25	C11100	1	C25010	10	D04036	8
B00004	25	C11125	1	C25011	10	D04050	8
B00005	25	C11150	1	C25012	10	D04051	8
B00006	25	C11200	1	C25013	10	D04053	8
B00007	25	C11250	1	C25020	10	D04054	8
B00008	26	C11300	1	C25021	10	D04055	8
B00009	26	C11400	1	C25022	10	D04056	8
B00010	26	C12050	2	C29123	30	D04057	8
B00011	26	C12075	2	C29124	30	D04058	8
B00013	26	C12100	2	C29126	30	D04059	8
B00014	26	C12125	2	C29150	30	D04060	8
B00015	26	C12150	2	C29200	30	D04062	8
B00016	26	C12200	2	C56100	33	D04064	7
B00017	26	C12250	2	C76605	19	D06005	18
B00018	26	C12300	2	C76606	19	D06050	18
B00019	25	C12400	2	C76607	19	D06075	18
B00020	26	C12600	2	C76608	19	D06100	18
B00021	25	C13050	2	C76612	19	D06125	18
B00022	25	C13075	2	C76613	19	D06150	18
B00023	25	C14050	1	C76614	19	D06200	18
B00024	25	C14075	1	C76615	19	D06250	18
B00025	25	C14100	1	C98001	30	D06300	18
B05900	6	C14205	1	C98002	30	D06350	18
B05901	6	C14206	1	CJ1002	9	D06400	18
B05910	6	C14207	1	D02001	30	D06450	19
B05911	6	C15050	1	D02002	30	D06500	19
B05920	6	C15075	1	D04001	8	D06510	19
B05921	6	C15100	1	D04002	8	D06525	19
B05922	6	C15125	1	D04003	8	D06550	19
B05923	6	C15150	1	D04004	8	D06600	19
B05924	6	C15151	1	D04005	7	D06650	19
B05925	6	C15200	1	D04008	7	D06700	19
B05926	6	C15201	1	D04009	7	D06750	18
B05927	6	C15300	1	D04010	8	D06753	19
B05928	6	C15301	1	D04012	7	D06755	18
B12210	5	C15302	1	D04013	8	D06800	19
B12320	5	C15303	1	D04014	8	D06801	19
B12430	5	C15304	1	D04015	8	D06802	19
B12640	5	C15305	1	D04016	8	D06803	19
BIN004	37	C15306	1	D04017	8	D06804	19
BIN005	37	C15307	1	D04018	8	D06805	19
BIN008	37	C16050	2	D04019	8	D06850	19
BIN012	37	C16075	2	D04020	8	D06875	19
BOX006	37	C17050	2	D04021	8	D06900	19
BOX008	37	C17075	2	D04022	8	D06901	19

PART NO.	PG #
D06902	19
D06903	19
D07025	18
D07050	18
D07075	18
D07100	18
D07125	18
D07150	18
D07200	18
D07350	18
D07750	18
D07755	18
D08001	6
D10001	6
D10625	6
D10875	6
D10900	7
D18000	5
D18001	4
D18002	4
D18034	4
D18060	4
D18186	4
D18340	4
D18400	4
D18401	4
D18402	4
D18501	4
D18560	4
D18750	4
D18850	4
E09050	2
E09075	2
E09100	2
E09125	2
E09150	2
E09200	2
E09250	2
E09300	2
E09400	2
E10150	5
E10200	5
E10300	5
E10400	5
F12009	24
F12012	24
F12018	24
F12024	24
F14012	25
F160063	25
F160093	25
F160094	25
F16012	25
F160123	25
F160126	25
F16016	25

PART NO.	PG #
F160183	25
F160184	25
F160186	25
F160243	25
F160246	25
F160363	25
F160393	25
F163186	25
F163246	25
F165181	25
F165186	25
F180032	25
F18009	24
F18012	24
F18018	24
F18024	24
F18309	24
F18312	24
F18318	24
F18324	24
F33009	32
F33010	32
F33011	32
F33012	32
F33013	32
F33014	32
F33030	32
F33031	32
F33032	32
F33033	32
F33034	32
F33035	32
F33036	32
F33037	32
F33038	32
F33039	32
F33040	32
F33041	32
F33060	32
F33061	32
F33062	32
F33063	32
F33064	32
F33065	32
F33066	32
F33067	32
F33068	32
F33069	32
F33080	33
F33081	33
F33082	33
F33083	33
F33094	33
F33095	33
F33096	33
F33097	33

PART NO.	PG #
F33098	33
F33101	32
F33102	32
F33103	32
F33104	32
F33105	32
F33106	32
F33107	32
F33108	32
F33109	32
F33110	32
F33111	32
F33112	32
F33113	32
F33114	32
F33115	32
F33116	32
F33120	33
F33121	33
F33122	33
F33123	33
F33124	33
F33125	33
F33126	33
F33127	33
F33128	33
F33129	33
F33130	33
F33131	33
F33132	33
F33140	32
F33141	32
F33142	32
F33143	32
F33144	32
F33300	32
F33301	32
F33302	32
F33303	32
G60000	21
G60001	21
G60005	20
G60015	21
G60030	21
G60055	20
G60060	21
G60100	21
G60160	21
G60200	21
G60300	21
G61005	21
G61015	21
G61030	21
G61060	21
G61100	21
G61160	21

PART NO.	PG #
G61200	21
G61300	21
G62030	21
G62060	21
G62100	21
G62200	21
G62300	21
G63001	22
G64000	22
G64001	22
G64002	22
G64004	22
G64005	21
G64015	21
G64020	22
G64030	22
G64055	20
G64060	22
G64100	22
G64101	21
G64155	22
G64160	22
G64200	22
G64300	22
G64301	22
G64333	22
G65055	20
G65155	22
G66000	21
G66002	21
G66015	21
G66030	21
G66060	21
G66100	21
G67000	21
G67002	21
G67015	21
G67030	21
G67060	21
G67100	21
H10052	27
H10054	27
H10056	27
H10058	27
H10072	27
H10074	27
H10076	27
H10078	27
H10080	27
H10106	27
H10108	27
H10110	27
H10126	27
H10128	27
H10156	27
H10158	27

PART NO.	PG #	PART NO.	PG #	PART NO.	PG #	PART NO.	PG #
H10208	27	H17250	34	H30022	26	H70300	34
H11054	27	H17300	34	H30033	26	H70350	34
H11056	27	H17350	34	H30044	26	H70400	34
H11058	27	H17400	34	H60050	33	H72050	35
H11074	27	H18050	28	H60075	33	H72075	35
H11076	27	H18075	28	H60375	33	H72100	35
H11078	27	H20001	29	H60625	33	H72125	35
H11080	27	H20002	29	H61375	33	H72150	35
H11106	27	H20003	29	H65050	34	H72200	35
H11108	27	H20005	29	H65075	34	H72250	35
H11126	27	H20006	29	H65100	34	H72300	35
H11156	27	H20007	29	H65125	34	H72375	35
H11208	27	H20010	29	H65150	34	H72400	35
H11210	27	H20011	29	H65200	34	H73050	35
H12054	26	H20012	29	H65250	34	H73075	35
H12056	26	H20100	29	H65300	34	H73100	35
H12074	26	H20150	29	H65400	34	H73125	35
H12076	26	H20500	29	H65500	34	H73150	35
H12106	26	H21010	29	H65600	34	H73200	35
H13038	28	H21025	29	H66050	34	H73375	35
H13050	28	H21050	29	H66075	34	H80050	35
H13075	28	H21100	29	H66100	34	H80375	35
H13100	28	H21101	29	H66125	34	H81050	35
H13125	28	H21200	29	H66150	34	H81375	35
H13150	28	H22050	27	H66200	34	H82050	35
H13200	28	H22075	27	H66250	34	H82375	35
H13250	28	H23050	27	H66300	34	H83050	33
H13300	28	H24038	28	H66400	34	H83075	33
H13400	28	H24050	28	H68050	34	H83100	33
H14050	34	H24075	28	H68075	34	H84050	33
H14075	34	H24100	28	H68100	34	H84075	33
H14100	34	H25050	28	H68125	34	H84100	33
H14125	34	H25075	28	H68150	34	H85050	33
H14150	34	H25100	28	H68200	34	H85075	33
H14200	34	H26050	28	H68250	34	H85100	33
H14250	34	H26075	28	H68300	34	I50058	17
H14300	34	H26100	28	H68350	34	I50075	17
H14350	34	H26125	28	H68400	34	I50078	17
H14400	34	H26150	28	H68500	34	I50118	17
H15001	27	H26200	28	H68600	34	I50138	17
H15050	28	H27050	28	H68800	34	I50158	17
H15075	28	H27075	28	H69050	34	I50178	17
H15100	28	H27100	28	H69075	34	I50218	17
H15125	28	H28050	28	H69100	34	I50238	17
H15150	28	H28075	28	H69150	34	I50258	17
H15200	28	H28100	28	H69200	34	I51058	17
H16038	28	H28125	28	H69250	34	I51078	17
H16050	28	H28150	28	H69300	34	I51118	17
H16075	28	H28200	28	H69400	34	I51138	17
H16100	28	H29000	28	H70050	34	I51158	17
H17050	34	H29010	28	H70075	34	I51178	17
H17075	34	H30001	26	H70100	34	I51218	17
H17100	34	H30002	26	H70125	34	I51238	17
H17125	34	H30003	26	H70150	34	I51258	17
H17150	34	H30004	26	H70200	34	I52034	17
H17200	34	H30011	26	H70250	34	I52058	17

PART NO.	PG #
I52078	17
I52118	17
I52138	17
I52158	17
I52178	17
I52218	17
I52238	17
I52258	17
I52318	17
I53058	17
I53075	17
I53078	17
I53100	17
I53118	17
I53138	17
I53158	17
I53178	17
I53218	17
I53238	17
I53258	17
I53312	17
I53318	17
I53358	17
I53412	17
I53418	17
I54050	17
I54058	17
I54075	17
I54078	17
I54115	17
I54118	17
I54138	17
I54158	17
I54178	17
I54218	17
I54258	17
I55058	17
I55075	17
I55078	17
I55115	17
I55118	17
I55138	17
I55158	17
I55178	17
I55218	17
I55258	17
I56058	17
I56075	17
I56078	17
I56118	17
I56138	17
I56158	17
I56218	17
I57058	18
I57078	18
I57115	18

PART NO.	PG #
I57118	18
I57138	18
I57158	18
I57178	18
I57218	18
I57238	18
I57258	18
I60025	13
I60038	13
I60050	13
I60058	13
I60075	13
I60078	13
I60118	13
I60138	13
I60158	13
I60200	13
I60218	13
I60250	13
I60258	13
I60300	13
I60318	13
I60350	13
I61038	13
I61050	13
I61058	13
I61075	13
I61078	13
I61118	13
I61138	13
I61158	13
I61200	13
I61218	13
I61250	13
I61258	13
I61300	13
I61318	13
I61350	13
I61358	13
I61418	13
I61450	13
I62038	13
I62050	13
I62058	13
I62075	13
I62078	13
I62118	13
I62138	13
I62158	13
I62200	13
I62218	13
I62250	13
I62258	13
I62300	13
I62318	13
I62350	13

PART NO.	PG #
I62358	13
I62418	13
I62450	13
I63058	13
I63075	13
I63078	13
I63118	13
I63138	13
I63158	13
I63200	13
I63218	13
I63250	13
I63258	13
I63300	13
I63318	13
I63350	13
I63358	13
I80034	14
I80038	14
I80050	14
I80058	14
I80078	14
I80118	14
I80138	14
I80150	14
I80158	14
I80200	14
I80218	14
I80250	14
I80258	14
I80318	14
I81034	14
I81038	14
I81050	14
I81058	14
I81078	14
I81118	14
I81138	14
I81150	14
I81158	14
I81200	14
I81218	14
I81250	14
I81258	14
I81300	14
I81318	14
I81358	14
I81400	14
I81418	14
I82034	14
I82038	14
I82050	14
I82058	14
I82078	14
I82118	14
I82138	14

PART NO.	PG #
I82150	14
I82158	14
I82200	14
I82218	14
I82250	14
I82258	14
I82300	14
I82318	14
I82358	14
I82400	14
I82418	14
I83034	14
I83058	14
I83078	14
I83118	14
I83138	14
I83150	14
I83158	14
I83200	14
I83218	14
I83250	14
I83258	14
I83300	14
I83318	14
I83358	14
I83418	14
IA1050	18
IA1100	18
IA2050	18
IA2100	18
INT001	18
INT002	18
IPC004	18
J01001	6
J01050	27
J01051	27
J01052	27
J01053	27
J01057	27
J01075	27
J01077	27
J01100	27
J01125	27
J01150	27
J01200	27
J01300	27
J01400	27
J04004	6
J04005	6
J04006	6
J04012	7
J04016	7
J04104	6
J04105	6
J04106	6
J04204	7

PART NO.	PG #	PART NO.	PG #	PART NO.	PG #	PART NO.	PG #
J04205	7	J40500	22	M12022	36	R50400	31
J04206	7	J40501	22	M12085	36	R57150	31
J04250	7	J40502	22	M12100	36	R57200	31
J04251	7	J40503	22	M15001	36	R57300	31
J34712	19	J40505	22	M15002	36	R57400	31
J34715	19	J40506	22	M15004	36	R60001	35
J34718	19	J40510	22	M15005	36	R60002	35
J34724	19	J40511	22	M15006	36	R60003	35
J34800	20	J40550	22	M15009	36	R60004	35
J34970	20	J40551	22	M20058	35	R60050	1
J34975	20	J40553	21	M20075	35	R60075	1
J34980	20	J40554	21	M20100	35	R60100	1
J35712	19	J40555	21	M20101	35	R60125	1
J35715	19	J40556	21	M20581	35	R60150	1
J35718	19	J40557	21	M20751	35	R60200	1
J35724	19	J40558	22	M25900	35	R60250	1
J36018	20	J40560	22	O15001	29	R60300	1
J36022	20	J40561	23	O15002	29	R60375	1
J36024	20	J40562	23	O15003	29	R60400	1
J36026	20	J40563	23	O15006	29	R60600	1
J36030	20	J40700	23	O15007	29	R70150	31
J36118	19	J40701	23	P55300	30	R70200	31
J36124	19	J40702	22	R15100	31	R70300	31
J36130	19	J40703	22	R15101	31	R70400	31
J36136	19	J40704	22	R15107	31	S04350	19
J36148	19	J40705	22	R15108	31	S04351	19
J36200	20	J66300	21	R15109	31	S04352	19
J36250	20	J66301	21	R15202	18	S04353	19
J36300	20	L40001	29	R15204	18	S04354	19
J36400	20	L40002	30	R15206	18	S04355	19
J36712	19	L42006	30	R16100	30	S04356	19
J36715	19	L42008	30	R16101	30	S04357	19
J36718	19	L42052	30	R16107	30	S04358	19
J36724	19	L42102	30	R16108	30	S04359	19
J37022	20	L42103	30	R30050	1	S04360	19
J37024	20	L42104	30	R30075	1	S04361	19
J37026	20	M05001	31	R30100	1	S16003	24
J37028	20	M05003	31	R30125	1	S16005	24
J37030	20	M05005	31	R30150	1	S16006	24
J38020	20	M06001	36	R30200	1	S16009	24
J38022	20	M06002	36	R30250	1	S16012	24
J38024	20	M06003	37	R30300	1	S16018	24
J38026	20	M06006	37	R30375	1	S16024	24
J38030	20	M06007	37	R30400	1	S163566	24
J38712	19	M06010	37	R30600	1	S180032	24
J38715	19	M07001	35	R40150	31	S20009	24
J38718	19	M07002	35	R40200	31	S20012	24
J38724	19	M12001	36	R40300	31	S22001	10
J39019	20	M12002	36	R40400	31	S22002	10
J39023	20	M12003	36	R45150	31	S22003	10
J39027	20	M12004	36	R45200	31	S22004	10
J39030	20	M12005	36	R45300	31	S22005	10
J39712	19	M12006	36	R45400	31	S22006	10
J39715	19	M12007	36	R50150	31	S26001	5
J39718	19	M12008	36	R50200	31	S26002	5
J39724	19	M12009	36	R50300	31	S26003	5

PART NO.	PG #
S26100	5
S27001	5
S27002	5
S30012	31
S30024	31
S33001	24
S33002	24
S33003	24
S33004	24
S33005	24
S33006	24
S33007	24
S33010	24
S33011	24
S33012	24
S33013	24
S33014	24
S33016	24
S33021	24
S33022	24
S33023	24
S33318	24
S33518	24
S51001	10
S51002	10
S51080	10
S51120	10
T06001	5
T06002	5
T06003	5
T06004	5
T06025	5
T06050	5
T06200	5
T06250	5
T06300	5
T06320	5
T06400	5
T06430	5
T06600	5
T06640	5
T06800	5
T07150	5
T07200	5
T07300	5
T07400	5
T12001	28
T12006	35
T12010	35
T12050	35
T12106	35
T12110	35
T16002	9
T16004	9
T16100	9
T17002	9

PART NO.	PG #
T17004	9
T17101	9
T17102	9
T17104	9
T18201	9
T18202	9
T19118	9
T19119	9
T19120	9
T19121	9
T19122	9
T19123	9
T19124	9
T19125	9
T19126	9
T19127	9
T19128	9
T19222	9
T19342	9
T19345	9
T20020	9
T20023	9
T20030	9
T20040	9
T20041	9
T20050	9
T20200	9
T25250	23
T25312	23
T25375	23
T25500	23
T25625	23
T26000	23
T26124	23
T26125	23
T26186	23
T26187	23
T26250	23
T26252	23
T26312	23
T26313	23
T26375	23
T26376	23
T26377	23
T26498	23
T26500	23
T26625	23
T26626	23
T26750	23
T26875	23
T27125	23
T27188	23
T27250	23
T27313	23
T27375	23
T27438	23

PART NO.	PG #
T27500	23
T27625	23
T30002	4
T30034	4
T30046	4
T30068	4
T30102	4
T30203	4
T30304	4
T31000	2
T31001	2
T31002	2
T31003	2
T31004	2
T31006	2
T32001	3
T32002	3
T32003	3
T32004	3
T32006	3
T32008	3
T32011	3
T32022	3
T32033	3
T32044	3
T33001	4
T33002	4
T33003	4
T33004	4
T33152	3
T33200	4
T33300	4
T33304	3
T33400	4
T34001	3
T34002	3
T34003	3
T34004	3
T34006	3
T34008	3
T34012	3
T34013	3
T34014	3
T34150	3
T34200	3
T34300	3
T34350	3
T34400	3
T35001	3
T35002	3
T35003	3
T35004	3
T35201	3
T35202	3
T35203	3
T35204	3

PART NO.	PG #
T35206	3
T36150	3
T36200	3
T36300	3
T36400	3
T36600	3
T37001	3
T37002	3
T37003	3
T37004	3
T37006	3
T37008	3
T38006	35
T38010	35
T38038	35
T38106	35
T38110	35
T39002	3
T39003	3
T39004	3
T39006	3
T39008	3
T39010	3
T39012	3
T40001	37
T40002	37
T40003	37
T40004	37
T40005	37
T40007	37
T40008	37
T45002	4
T45003	4
T45010	4
T45012	4
T45150	4
T45200	4
T45300	4
T45400	4
T45600	4
T45800	4
T46200	4
T46300	4
T46400	4
T60000	29
T60001	29
T60002	29
T60003	29
T60005	29
T60006	29



SECTION D - FITTINGS & VALVES

VOLUME V



Quality
Products *for*
the Plumbing
Professional

Brass Compression Fittings	1-2
Chrome Plated Compression Fittings	3
45° Flare Tube Fittings	4-5
Space Heater & Gas Range Fittings	6
Yellow Brass Pipe Fittings	7-8
PEX Fittings	9-10
Push On Fittings	11-15
Red Brass Pipe Fittings	16-17
Bronze Pipe Fittings	18-20
Chrome Plated Pipe Nipples & Fittings	21-22
Brass Garden Hose Fittings	23-24
Brass Hose Barbs	25
Nylon Fittings.....	26-27
Poly Insert Fittings.....	28
Red Brass Insert Fittings.....	29
Galvanized Insert Fittings.....	30
Brass Needle Valves	31
Shut-Off Vavles	32
Drain Cocks/Air Cocks.....	33
Ball Valves	34-36
Valves	37
Hose Bibbs	38
Gear Clamps	39-40
Flange Connection Gaskets & Kits	41-42
Rubber Sheet/Gasket Material	43
Water Hammer Arresters	44

Compression Cap

Style 61C



PART NO.	TUBE SIZE
C74001	1/4"
C74002	3/8"
C74147	1/2"
C74155	5/8"

Compression Sleeve

Style 60



PART NO.	TUBE SIZE
C74003	1/8"
C74004	3/16"
C74005	1/4"
C74006	5/16"
C74007	3/8"
C74151	7/16"
C74008	1/2"
C74009	5/8"
C74010	3/4"
C74011	7/8"

Compression Nuts

Style 61



• CARTON QUANTITIES ONLY

PART NO.	TUBE SIZE
C74012	1/8"
C74013	3/16"
C74014	1/4"
C74015	5/16"
C74016	3/8"
C74152	7/16"
C74017	1/2"
C74018	5/8"
C74019	3/4"
C74020	7/8"

Delrin Compression Sleeve

Style 60P



• CARTON QUANTITIES ONLY

PART NO.	TUBE SIZE	CTN. QTY.
C74096	1/4"	100
C74097	3/8"	100
C74098	1/2"	50
C74099	5/8"	50

Brass Compression Insert

Style 63P



PART NO.	TUBE SIZE	CTN. QTY.
C74100	1/4"	100
C74100T	1/4"	10
C74101	3/8"	100
C74101T	3/8"	10
C74102	1/2"	50
C74103	5/8"	50

Compression Union

Style 62



PART NO.	TUBE SIZE
C74021	1/8"
C74022	3/16"
C74023	1/4"
C74024	5/16"
C74025	3/8"
C74154	7/16"
C74026	1/2"
C74027	5/8"
C74028	3/4"
C74029	7/8"
C74030	3/8" x 1/4"
C74031	1/2" x 3/8"
C74032	5/8" x 3/8"
C74033	5/8" x 1/2"

Compression Tee

Style 64



PART NO.	TUBE SIZE
C74034	1/4"
C74035	5/16"
C74036	3/8"
C74037	3/8" x 3/8" x 1/4"
C74038	1/2"
C74104	1/2" x 1/2" x 3/8"
C74039	5/8"
C74145	5/8" x 5/8" x 3/8"
C74106	5/8" x 5/8" x 1/2"
C74107	3/4"
C74108	7/8"

Compression x FIP Branch Tee

Style 78



PART NO.	TUBE x FIP
C74091	3/8" x 1/8"
C74092	3/8" x 1/4"

Compression x MIP Branch Tee

Style 72



PART NO.	TUBE x MIP
C74056	3/8" x 1/4"
C74057	3/8" x 3/8"

Compression x FIP Connector

Style 66



PART NO.	TUBE x FIP
C74045	1/4" x 1/8"
C74046	1/4" x 1/4"
C74113	1/4" x 3/8"
C74114	1/4" x 1/2"
C74115	5/16" x 1/8"
C74047	5/16" x 1/4"
C74048	3/8" x 1/8"
C74049	3/8" x 1/4"
C74050	3/8" x 3/8"
C74051	3/8" x 1/2"
C74156	3/8" x 3/4"
C74116	1/2" x 1/4"
C74052	1/2" x 3/8"
C74053	1/2" x 1/2"
C74117	1/2" x 3/4"
C74054	5/8" x 1/2"
C74118	5/8" x 3/4"
C74119	3/4" x 1/2"
C74120	3/4" x 3/4"
C74150	7/8" x 1/2"
C74055	7/8" x 3/4"

Compression Elbow

Style 65



PART NO.	TUBE SIZE
C74040	1/4"
C74041	3/8"
C74042	1/2"
C74109	1/2" x 3/8"
C74043	5/8"
C74044	5/8" x 3/8"
C74110	5/8" x 1/2"
C74111	3/4"
C74112	7/8"

Compression x FIP Elbow

Style 70



PART NO.	TUBE x MIP
C74074	1/4" x 1/8"
C74075	1/4" x 1/4"
C74127	1/4" x 3/8"
C74128	1/4" x 1/2"
C74129	3/8" x 1/8"
C74076	3/8" x 1/4"
C74077	3/8" x 3/8"
C74078	3/8" x 1/2"
C74130	1/2" x 1/4"
C74131	1/2" x 3/8"
C74079	1/2" x 1/2"
C74080	5/8" x 1/2"
C74132	5/8" x 3/4"

Compression x MIP Connector

Style 68



PART NO.	TUBE x MIP
C74121	1/8" x 1/8"
C74122	3/16" x 1/8"
C74058	1/4" x 1/8"
C74059	1/4" x 1/4"
C74060	1/4" x 3/8"
C74123	1/4" x 1/2"
C74061	5/16" x 1/8"
C74062	5/16" x 1/4"
C74063	3/8" x 1/8"
C74064	3/8" x 1/4"
C74065	3/8" x 3/8"
C74066	3/8" x 1/2"
C74067	3/8" x 3/4"
C74068	1/2" x 1/4"
C74069	1/2" x 3/8"
C74070	1/2" x 1/2"
C74124	1/2" x 3/4"
C74146	5/8" x 3/8"
C74071	5/8" x 1/2"
C74072	5/8" x 3/4"
C74125	3/4" x 1/2"
C74126	3/4" x 3/4"
C74149	7/8" x 1/2"
C74073	7/8" x 3/4"
C74157	7/8" x 1"

Compression x MIP Elbow

Style 69



PART NO.	TUBE x MIP
C74133	1/8" x 1/8"
C74134	3/16" x 1/8"
C74081	1/4" x 1/8"
C74082	1/4" x 1/4"
C74135	1/4" x 3/8"
C74136	1/4" x 1/2"
C74083	5/16" x 1/8"
C74084	5/16" x 1/4"
C74137	3/8" x 1/8"
C74085	3/8" x 1/4"
C74086	3/8" x 3/8"
C74087	3/8" x 1/2"
C74138	3/8" x 3/4"
C74139	1/2" x 1/4"
C74088	1/2" x 3/8"
C74089	1/2" x 1/2"
C74140	1/2" x 3/4"
C74141	5/8" x 3/8"
C74090	5/8" x 1/2"
C74142	5/8" x 3/4"
C74143	3/4" x 1/2"
C74144	3/4" x 3/4"
C74148	7/8" x 3/4"

Compression x Sweat Adapter

Style 666



PART NO.	TUBE x OD
C74093	3/8" x 5/8" (1/2" swt)

Pilot Line Breakaway Nut



PART NO.	DESCRIPTION
C74158	1/4" OD

Chrome Plated Compression Nut



PART NO.	TUBE SIZE
C74094	3/8"
C74095	1/2"
N61010	5/8"

Compression x FIP Elbow



PART NO.	TUBE x FIP
N70066	3/8" x 3/8"
N70068	3/8" x 1/2"
N70086	1/2" x 3/8"
N70088	1/2" x 1/2"

Chrome Union



PART NO.	TUBE SIZE
N62006	3/8"
N62008	1/2"
N62010	5/8"
N62086	1/2" x 3/8"
N62106	5/8" x 3/8"
N62108	5/8" x 1/2"

Compression x MIP Elbow



PART NO.	TUBE x MIP
N69066	3/8" x 3/8"
N69068	3/8" x 1/2"
N69086	1/2" x 3/8"
N69088	1/2" x 1/2"

Chrome Elbow



PART NO.	TUBE SIZE
N65106	5/8" x 3/8"

3' Chrome Plated Brass Cover Tubes

- Plain ends (no threads)
- 20 gauge



PART NO.	DESCRIPTION	CTN. QTY.
T73125	1-1/4" OD x 3' tube	1
T73138	1-3/8" OD x 3' tube	1
T73150	1-1/2" OD x 3' tube	1
T73175	1-3/4" OD x 3' tube	1
T73200	2" OD x 3' tube	1

Compression x FIP Connector



PART NO.	TUBE x FIP
N66066	3/8" x 3/8"
N66068	3/8" x 1/2"
N66086	1/2" x 3/8"
N66088	1/2" x 1/2"

Compression x MIP Connector



PART NO.	TUBE x MIP
N68066	3/8" x 3/8"
N68068	3/8" x 1/2"
N68086	1/2" x 3/8"
N68088	1/2" x 1/2"

Compression x Sweat Adapter



PART NO.	TUBE x OD
N66610	3/8" x 5/8" (1/2" swt)

Short Flare Nut

Style 41S



PART NO.	TUBE SIZE
F40001	3/16"
F40002	1/4"
F40003	5/16"
F40004	3/8"
F40005	1/2"
F40006	5/8"
F40007	3/4"
F40126	7/8"

Flare Tees

Style 44



PART NO.	TUBE SIZE
F40033	1/4"
F40034	5/16"
F40035	3/8"
F40036	1/2"
F40037	5/8"
F40124	3/4"
F40038	3/8"x 3/8"x 1/4"
F40039	1/2"x 1/2"x 3/8"
F40120	5/8"x 5/8"x 1/2"

Long Flare Nut

Style 641FS Style 41L



PART NO.	TUBE SIZE
F40008	3/8"
F40131	1/4"
F40132	1/2"
F40133	5/8"

Flare x MIP Branch Tee

Style 45



PART NO.	TUBE x MIP
F40040	3/8"x 1/4"
F40041	3/8"x 3/8"

Short Forged Flare Nut

Style 641 FS



PART NO.	TUBE SIZE
F40009	1/4"
F40010	3/8"
F40011	1/2"
F40012	5/8"
F40013	3/8"x 1/4"
F40014	1/2"x 3/8"
F40119	5/8"x 1/2"

Female Flare Swivel

Style 70



PART NO.	TUBE SIZE
F40125	1/4"
F40095	3/8"
F40096	1/2"
F40097	5/8"

Plug

Style 39



PART NO.	TUBE SIZE
F40015	1/4"
F40016	3/8"
F40017	1/2"
F40018	5/8"

Flare Union

Style 42



PART NO.	TUBE SIZE
F40123	3/16"
F40023	1/4"
F40024	5/16"
F40025	3/8"
F40026	1/2"
F40027	5/8"
F40100	3/4"
F40127	7/8"
F40028	3/8"x 1/4"
F40029	1/2"x 1/4"
F40030	1/2"x 3/8"
F40031	5/8"x 3/8"
F40032	5/8"x 1/2"

Cap

Style 40



PART NO.	TUBE SIZE
F40019	1/4"
F40098	5/16"
F40020	3/8"
F40021	1/2"
F40022	5/8"

Flare x MIP Half Union

Style 48



PART NO.	TUBE x MIP
F40062	3/16" x 1/8"
F40063	1/4" x 1/8"
F40064	1/4" x 1/4"
F40107	1/4" x 3/8"
F40108	1/4" x 1/2"
F40065	5/16" x 1/8"
F40066	5/16" x 1/4"
F40067	3/8" x 1/8"
F40068	3/8" x 1/4"
F40069	3/8" x 3/8"
F40070	3/8" x 1/2"
F40071	3/8" x 3/4"
F40072	1/2" x 1/4"
F40073	1/2" x 3/8"
F40074	1/2" x 1/2"
F40075	1/2" x 3/4"
F40109	5/8" x 3/8"
F40076	5/8" x 1/2"
F40077	5/8" x 3/4"
F40110	3/4" x 1/2"
F40112	3/4" x 3/4"
F40122	7/8" x 3/4"

Flare Elbow

Style 55



PART NO.	TUBE SIZE
F40078	1/4"
F40079	3/8"
F40080	1/2"
F40081	5/8"

Flare x FIP Elbow

Style 50



PART NO.	TUBE x FIP
F40104	1/4" x 1/4"
F40105	1/4" x 3/8"
F40056	3/8" x 1/4"
F40057	3/8" x 3/8"
F40058	3/8" x 1/2"
F40059	1/2" x 3/8"
F40060	1/2" x 1/2"
F40061	5/8" x 1/2"
F40106	5/8" x 3/4"
F40135	1/2" x 3/4"

Flare x FIP Coupling

Style 46



PART NO.	TUBE x FIP
F40042	1/4" x 1/8"
F40043	1/4" x 1/4"
F40117	1/4" x 3/8"
F40118	1/4" x 1/2"
F40044	5/16" x 1/8"
F40045	5/16" x 1/4"
F40046	3/8" x 1/8"
F40047	3/8" x 1/4"
F40048	3/8" x 3/8"
F40049	3/8" x 1/2"
F40050	3/8" x 3/4"
F40051	1/2" x 1/4"
F40052	1/2" x 3/8"
F40053	1/2" x 1/2"
F40054	1/2" x 3/4"
F40055	5/8" x 1/2"
F40101	5/8" x 3/4"
F40102	3/4" x 1/2"
F40103	3/4" x 3/4"
F40121	7/8" x 3/4"

Flare x MIP Elbow

Style 49



PART NO.	TUBE x MIP
F40082	1/4" x 1/8"
F40083	1/4" x 1/4"
F40113	1/4" x 3/8"
F40084	5/16" x 1/8"
F40085	5/16" x 1/4"
F40086	3/8" x 1/8"
F40087	3/8" x 1/4"
F40088	3/8" x 3/8"
F40089	3/8" x 1/2"
F40090	3/8" x 3/4"
F40091	1/2" x 3/8"
F40114	1/2" x 1/4"
F40092	1/2" x 1/2"
F40093	1/2" x 3/4"
F40128	5/8" x 3/8"
F40094	5/8" x 1/2"
F40115	5/8" x 3/4"
F40111	3/4" x 1/2"
F40116	3/4" x 3/4"

Space Heater Fittings

Nut



• 9/16"-24 Fine threaded flare

PART NO.	OD
F41001	3/8"
F41002	3/8"x 1/4"

Cap



• 9/16"-24 Fine threaded flare

PART NO.	OD
F41003	3/8"

Union



• 9/16"-24 Fine threaded flare

PART NO.	OD
F41008	3/8"

Female Coupling



• 9/16"-24 Fine threaded flare

PART NO.	OD x FIP
F41004	3/8"x 3/8"
F41005	3/8"x 1/2"

Male Half Union



• 9/16"-24 Fine threaded flare

PART NO.	OD x MIP
F41006	3/8"x 3/8"
F41007	3/8"x 1/2"

Tee



• 9/16"-24 Fine threaded flare

PART NO.	OD
F41009	3/8"

Female Elbow



• 9/16"-24 Fine threaded flare

PART NO.	OD x FIP
F41011	3/8" x 1/2"

Male Elbow



• 9/16"-24 Fine threaded flare

PART NO.	OD x MIP
F41012	3/8" x 3/8"
F41013	3/8" x 1/2"

Gas Range Fittings

Flare x Male



• CARTON QUANTITY: 5

PART NO.	OD x MIP
F48108	5/8" (15/16-16)x 1/2"
F481012	5/8" (15/16-16)x 3/4"

Flare x Female



• CARTON QUANTITY: 5

PART NO.	OD x FIP
F46108	5/8"(15/16-16) x 1/2"
F461012	5/8" (15/16-16) x 3/4"

Flare Cap & Nut



• CARTON QUANTITY: 5

PART NO.	SIZE
F401516 (cap)	15/16"
F411516 (nut)	15/16"

90° Elbow



PART NO.	IPT
P20002	1/8"
P20004	1/4"
P20006	3/8"
P20008	1/2"

90° Male Elbow



PART NO.	IPT
P13986	1/2"

90° Street Elbow



PART NO.	IPT
P16002	1/8"
P16004	1/4"
P16006	3/8"
P16008	1/2"

45° Elbow



PART NO.	IPT
P10452	1/8"
P10454	1/4"

45° Street Elbow



PART NO.	IPT
P12402	1/8"
P12404	1/4"
P12406	3/8"
P12408	1/2"

Tee



PART NO.	IPT
P10012	1/8"
P10014	1/4"
P10016	3/8"
P10018	1/2"

Bell Reducer



PART NO.	IPT
P19042	1/4" x 1/8"
P19062	3/8" x 1/8"
P19064	3/8" x 1/4"
P19082	1/2" x 1/8"
P19084	1/2" x 1/4"
P19086	1/2" x 3/8"
P19128	3/4" x 1/2"

Coupling



PART NO.	IPT
P10032	1/8"
P10034	1/4"
P10036	3/8"
P10038	1/2"
P10312	3/4"

Cap



PART NO.	IPT
P10082	1/8"
P10084	1/4"
P10086	3/8"
P10088	1/2"
P10812	3/4"

Square Head Plug



PART NO.	IPT
P10092	1/8"
P10094	1/4"
P10096	3/8"
P10098	1/2"
P10912	3/4"

HEX Head Plug



PART NO.	IPT
P12102	1/8"
P12104	1/4"
P12106	3/8"
P12108	1/2"
P12112	3/4"

Countersunk Plug



PART NO.	IPT
P20092	1/8"
P20094	1/4"
P20096	3/8"
P20098	1/2"

Lock Nut



PART NO.	IPT
P11102	1/8"
P11104	1/4"
P11106	3/8"
P11108	1/2"

HEX Bushing



PART NO.	IPT
P11042	1/4" x 1/8"
P11062	3/8" x 1/8"
P11064	3/8" x 1/4"
P11082	1/2" x 1/8"
P11084	1/2" x 1/4"
P11086	1/2" x 3/8"
P11122	3/4" x 1/8"
P11124	3/4" x 1/4"
P11126	3/4" x 3/8"
P11128	3/4" x 1/2"

Face Bushing



PART NO.	IPT
P11964	3/8" x 1/4"
P11986	1/2" x 3/8"
P11928	3/4" x 1/2"

Close Nipple



PART NO.	IPT
P11202	1/8"
P11204	1/4"
P11206	3/8"
P11208	1/2"
P11212	3/4"

Long Nipple



PART NO.	IPT
P13224	1/8" x 1-1/2"
P13232	1/8" x 2"
P13424	1/4" x 1-1/2"
P13432	1/4" x 2"
P13624	3/8" x 1-1/2"
P13632	3/8" x 2"

HEX Nipple



PART NO.	IPT
P12202	1/8"
P12204	1/4"
P12206	3/8"
P12208	1/2"
P12212	3/4"
P12342	1/4" x 1/8"
P12362	3/8" x 1/8"
P12364	3/8" x 1/4"
P12384	1/2" x 1/4"
P12386	1/2" x 3/8"
P12328	3/4" x 1/2"

Brass PEX Couplings



PART NO.	SIZE	CTN. QTY.
C76001	1/2"	100/1000
C76002	3/4"	50/500
C76003	1"	50/300
C76004	3/4" x 1/2"	50/500
C76005	1" x 3/4"	50/400

Brass PEX 90° Ell



PART NO.	SIZE	CTN. QTY.
C76008	1/2"	100/800
C76009	3/4"	50/400
C76010	1"	25/200

Brass PEX x MIP 90° Ell



PART NO.	SIZE	CTN. QTY.
C76013	1/2" x 1/2"	50/400

Brass PEX Equal Tee



PART NO.	SIZE	CTN. QTY.
C76014	1/2"	50/500
C76015	3/4"	50/300
C76016	1"	25/200

Brass PEX Tee



PART NO.	SIZE	CTN. QTY.
C76017	1/2" x 1/2" x 3/4"	50/300
C76018	3/4" x 1/2" x 1/2"	50/300
C76019	3/4" x 1/2" x 3/4"	50/300
C76020	3/4" x 3/4" x 1/2"	50/300
C76021	1" x 3/4" x 3/4"	25/200
C76022	1" x 1" x 1/2"	25/200
C76023	1" x 1" x 3/4"	25/200
C76024	3/4" x 3/4" x 1"	25/200
C76025	1" x 3/4" x 1/2"	25/200

Brass PEX x Female Sweat Adapter



PART NO.	PEX x FSW	CTN. QTY.
C76027	1/2" x 1/2"	100/1000
C76028	3/4" x 3/4"	50/400
C76029	1/2" x 3/4"	50/400
C76030	1" x 1"	25/200

Brass PEX x Male Adapter



PART NO.	PEX x MIP	CTN. QTY.
C76034	1/2" x 1/2"	50/400
C76035	1/2" x 3/4"	25/200
C76036	3/4" x 3/4"	25/200
C76037	1" x 1"	25/100
C76038	1" x 3/4"	25/200

Brass PEX x FIP Female Adapter



PART NO.	PEX x FIP	CTN. QTY.
C76041	1/2" x 1/2"	50/400
C76042	1/2" x 3/4"	50/200
C76043	3/4" x 3/4"	50/200
C76044	1" x 1"	25/100

Brass PEX x Male Sweat Adapter



PART NO.	PEX x MALE	CTN. QTY.
C76047	3/8" x 1/2"	100/1000
C76048	1/2" x 1/2"	100/1000
C76049	1/2" x 3/4"	50/400
C76050	3/4" x 3/4"	50/400
C76051	1" x 1"	25/200

Brass PEX x FIP Swivel Plastic Nut



PART NO.	PEX x FIP	CTN. QTY.
C76055	3/8" x 1/2"	50/500
C76056	1/2" x 1/2"	50/500
C76057	1/2" x 7/8"	50/400

Brass PEX x FIP 90° Ell Swivel Plastic Nut



PART NO.	PEX x FIP	CTN. QTY.
C76060	1/2" x 1/2"	50/400
C76061	1/2" x 7/8"	50/400

Brass PEX Ball Valve



PART NO.	PEX x FIP	CTN. QTY.
B63050	1/2"	1
B63075	3/4"	1
B63100	1"	1

Brass PEX Plug



PART NO.	PEX x FIP	CTN. QTY.
C76065	1/2"	200/1600
C76066	3/4"	100/800
C76067	1"	50/400

Brass PEX Crimp Ring



PART NO.	PEX x FIP	CTN. QTY.
C76070	3/8"	100/2000
C76071	1/2"	100/2000
C76072	3/4"	100/2000
C76073	1"	100/1000

Brass PEX x FIP Drop Ear 90° Ell



PART NO.	PEX x FIP	CTN. QTY.
C76080	1/2" x 1/2"	25/200
C76081	3/4" x 1/2"	25/200
C76079	1/2" x 1/2"	25/200

C76-080

C76-079

Oetiker PEX Stainless Steel Clamp



- The original patented pex assembly clamp designated by ASTM F 2098
- Ingenious stepless design provides uniform compression for a 360° watertight seal
- Available for 3/8", 1/2", 3/4" and 1" ASTM F 876/877 pex tubing sizes
- Specified for use with ASTM F 1807 and F 2159 insert fittings

PART NO.	SIZE	CTN. QTY.
C76074	3/8"	100/6000
C76075	1/2"	100/2000
C76076	3/4"	50/2000
C76077	1"	50/1300

TECHNICAL DATA

APPLICATION: HOT AND PLUMBING & HYDRONIC HEATING COLD WATER

MAXIMUM OPERATING TEMPERATURE: 180°F

MAXIMUM OPERATING PRESSURE (PSI): 100

MATERIAL: STAINLESS STEEL UNS S304000

Plastic PEX Tee

Lead Free



- Listed by Warnock Hersey
- Meets CSA1375-05, NSF61 and ASTM-F877
- Will not rust or corrode
- Unaffected by household cleaners and chemicals
- Smooth interior for better water flow
- Resists scale build-up

PART NO.	SIZE	CTN. QTY.
C76700	1/2"	1
C76701	3/4"	1

Plastic Pex Elbow

Lead Free



- Listed by Warnock Hersey
- Meets CSA1375-05, NSF61 and ASTM-F879
- Will not rust or corrode
- Unaffected by household cleaners and chemicals
- Smooth interior for better water flow
- Resists scale build-up

PART NO.	SIZE	CTN. QTY.
C76702	1/2"	1
C76703	3/4"	1

Plastic Pex Coupling

Lead Free



- Listed by Warnock Hersey
- Meets CSA1375-05, NSF61 and ASTM-F881
- Will not rust or corrode
- Unaffected by household cleaners and chemicals
- Smooth interior for better water flow
- Resists scale build-up

PART NO.	SIZE	CTN. QTY.
C76704	1/2"	1
C76705	3/4"	1
C76706	3/4" x 1/2"	1

Plastic Pex Adapter

Lead Free



- Listed by Warnock Hersey
- Meets CSA1375-05, NSF61 and ASTM-F884
- Will not rust or corrode
- Unaffected by household cleaners and chemicals
- Smooth interior for better water flow
- Resists scale build-up

PART NO.	PEX x MPT	CTN. QTY.
C76707	1/2" x 1/2"	1
C76708	3/4" x 3/4"	1

Plastic Pex Tee

Lead Free



- Listed by Warnock Hersey
- Meets CSA1375-05, NSF61 and ASTM-F886
- Will not rust or corrode
- Unaffected by household cleaners and chemicals
- Smooth interior for better water flow
- Resists scale build-up

PART NO.	SIZE	CTN. QTY.
C76709	1/2" x 1/2" x 3/4"	1
C76710	3/4" x 1/2" x 1/2"	1
C76711	3/4" x 1/2" x 3/4"	1
C76712	3/4" x 3/4" x 1/2"	1

PlumBite Push On Fittings

- Heat free method for joining Copper, CPVC and PEX tube and are designed to save time and money on installations
- To make an effective joint with PEX tube, the included liner must be used. (DO NOT SUBSTITUTE with other manufacturer's liner.)
- Push fit
- Reduced installation time
- Ideal for service and repair
- "O-ring" design for leak free seals
- EPDM O-ring seal
- 316 Stainless steel retaining ring
- Designed for use with ASTM B88 hard drawn and annealed copper tube, type K, L, or M, in the 1/2" through 3/4" size range; CPVC water tube per ASTM D2846/2846M and PEX tube that meets the requirements of ASTM F876 & F877
- Operate at temperatures from 0° to 250°F at a maximum working pressure of 200 PSI
- Sold in bag quantity only

Type of Service	System Operating Conditions
FLUIDS	
Hot and Cold Potable Water	32°F to 200°F, max. 200 PSI
Potable Water System Flushing	Compliant with major plumbing codes
Chilled Water w/Corrosion Inhibitors	0°F to 250°F, max 200 PSI Ethylene Glycol - 50% max. concentration Propylene Glycol - 50% max. concentration
Hydronic Heating	0°F to 250°F, max 200 concentration Ethylene Glycol - 50% max. concentration Propylene Glycol - 50% max. concentration
Rainwater/Greywater	32° F to 250°F, max. 200 PSI

Coupling



PART NO.	SIZE	CTN QTY
C76500	1/2"	10
C76501	3/4"	10
C76550	1"	6

Reducer Coupling



PART NO.	SIZE	CTN QTY
C76502	3/4" x 1/2"	10
C76551	1" x 3/4"	6

Adapter C x F



PART NO.	SIZE	CTN QTY
C76503	1/2"	10
C76504	3/4"	10
C76553	1"	6

Adapter C x M



PART NO.	SIZE	CTN QTY
C76505	1/2"	10
C76506	3/4"	10
C76554	1"	6

90° Ell



PART NO.	SIZE	CTN QTY
C76507	1/2"	10
C76508	3/4"	10
C76558	1"	6

Drob Ear 90° Ell C x F



PART NO.	SIZE	CTN QTY
C76509	1/2"	10

Tee



PART NO.	SIZE	CTN QTY
C76510	1/2"	10
C76511	3/4"	10
C76512	3/4" x 3/4" x 1/2"	10
C76513	3/4" x 1/2" x 3/4"	5
C76514	3/4" x 1/2" x 1/2"	5
C76555	1"	4
C76556	1" x 1" x 3/4"	4

Cap



PART NO.	SIZE	CTN QTY
C76515	1/2"	10
C76516	3/4"	10
C76557	1"	6

Ball Valve



PART NO.	SIZE	CTN QTY
C76561	1/2"	10
C76562	3/4"	10
C76563	1"	6

Repair Coupling



PART NO.	SIZE	CTN QTY
C76530	1/2"	70
C76531	3/4"	70
C76532	1"	40

Supply Stop



PART NO.	SIZE	CTN QTY
C76570	Straight 1/2" x 3/8"OD	1
C76571	Angle 1/2" x 3/8"OD	1

Removal Tool



PART NO.	SIZE	CTN QTY
C76520	1/2"	10
C76521	3/4"	10
C76522	1"	10

Twist To Lock Plastic Fittings

- IAPMO Listed NSF-61, ASSE 1061
- Reduced installation time
- Ideal for service and repair
- "O-ring" design for leak-free seals
- Working temps and pressure:
180PSI@68°F, 100PSI@150°F, 45PSI@180°F

INSTRUCTIONS FOR USE

To Connect: Squarely cut tubing or pipe to desired length, removing all burrs. Push fitting onto the end of tube or pipe. Fitting will grip before it seals. Ensure that tubing or pipe is pushed into the fitting until the end is fully seated into the internal tube stop.



To Lock Fitting: Twist the screw cap until colored line is no longer visible.



To Disconnect: Unlock fitting by twisting until colored line is visible and clicking sound is heard. Press collet squarely against the face of tubing to remove from fitting. Fitting may be reused.



Plastic inserts are required for plastic pipe connections in heating installations. It is recommended to use pipe inserts for plastic pipe connections in standard residential plumbing (hot and cold water) installations.

Drop Ear Elbow CTS



PART NO.	SIZE	CTN QTY
C76800	1/2"	3

Enlarger Connector CTS STACK x CTS



PART NO.	SIZE	CTN QTY
C76801	3/4" x 1"	3

Female Adapter CTS x FIP



PART NO.	SIZE	CTN QTY
C76802	1/2" x 1/2"	3
C76803	1/2" x 3/4"	3
C76804	3/4" x 3/4"	3
C76805	1" x 1"	3

Female Garden Hose Adapter CTS x FGH



PART NO.	SIZE	CTN QTY
C76806	1/2" x 3/4"	3

Male Adapter CTS x MIP



PART NO.	SIZE	CTN QTY
C76807	1/2" x 1/2"	3
C76808	1/2" x 3/4"	3
C76809	3/4" x 3/4"	3

Male Elbow CTS x MIP



PART NO.	SIZE	CTN QTY
C76810	1/2" x 1/2"	3

Reducing Connector CTS x CTS Stem



PART NO.	SIZE	CTN QTY
C76811	1/2" x 3/4"	3

Swivel Elbow Union CTS x FIP



PART NO.	SIZE	CTN QTY
C76812	1/2" x 1/2"	3

Swivel Union Connector CTS x BC



PART NO.	SIZE	CTN QTY
C76813	1/2" x BC	3

Tube End Stop CTS



PART NO.	SIZE	CTN QTY
C76814	1/2"	3
C76815	3/4"	3
C76816	1"	3

Tube Elbow Union CTS x CTS Stem



PART NO.	SIZE	CTN QTY
C76817	1/2" x 1/2"	3
C76818	3/4" x 3/4"	3

Elbow Union CTS x CTS



PART NO.	SIZE	CTN QTY
C76819	1/2"	3
C76820	3/4"	3
C76821	1"	3

Tube Tee Union Connector CTS x CTS x CTS Stem

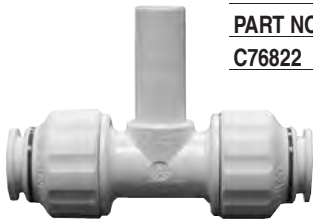

PART NO.	SIZE	CTN QTY
C76822	1/2" x 1/2" x 1/2"	3

Stack Tube Tee Union CTS



PART NO.	SIZE	CTN QTY
C76823	1/2"	3
C76824	3/4"	3

Union Connector CTS x CTS



PART NO.	SIZE	CTN QTY
C76825	3/8"	3
C76826	1/2" x 3/8"	3
C76827	1/2"	3
C76828	3/4" x 1/2"	3
C76829	3/4"	3
C76830	1" x 3/4"	3
C76831	1"	3

Tee Union CTS x CTS x CTS



PART NO.	SIZE	CTN QTY
C76832	1/2"	3
C76833	3/4" x 3/4" x 1/2"	3
C76834	3/4"	3
C76835	1"	3
C76836	1" x 3/4" x 3/4"	3
C76837	3/4" x 1/2" x 1/2"	3

Hand Vavle Union Connector CTS x CTS



PART NO.	SIZE	CTN QTY
C76838	1/2"	3
C76839	3/4"	3

Plastic Push On Fittings

- Quick and easy installation
- Very durable and fatigue resistant
- Manufactured from safe, non-toxic materials meeting the requirements of the US FDA, WRAS, ANSI/NSF-51, 61 and SK Zert
- All connections can be assembled and disassembled repeatedly



1. Cut the part of the tube to be inserted into the fitting to plane the end.

2. Make sure to use a clean tube without any foreign material or cracks.



3. When inserting the tube, remove any obstructions before fully inserting the tube. Make sure the tube is fully inserted.

4. Inserting the tube into the fitting only takes moderate force. The tube or fitting should not be scratched or damaged in the process, as this is the main cause for water leaks later on.



5. To make sure that the fitting is properly connected to the tube, pull it once. After pulling, insert a spanner under the collet and push the tube into the fitting once more for a complete insertion.



6. When no play is desired for the fitting and tube, use our company's LC to eliminate the play of the fitting.



7. Make sure to completely eliminate pressure before disassembling the fitting.

8. When disassembling the tube, push the clip in direction to the main assembly and then pull the tube out for easy disassembling.

9. Fittings and tubes can be reused.

Straight Needle Valve CTS x MIP



PART NO.	SIZE	CTN QTY
C76840	1/4" x 1/4"	5
C76841	3/8" x 3/8"	5

Straight Needle Valve CTS



PART NO.	SIZE	CTN QTY
C76842	1/4"	5
C76843	3/8"	5

Angle Valve CTS x FIP



PART NO.	SIZE	CTN QTY
C76844	1/4" x 1/4"	5
C76845	3/8" x 3/8"	5

Straight Valve CTS x MIP



PART NO.	SIZE	CTN QTY
C76846	1/4" x 1/4"	5
C76847	3/8" x 3/8"	5

Straight Valve OD x CTS



PART NO.	SIZE	CTN QTY
C76848	1/4"	5
C76849	3/8"	5

End Cap CTS



PART NO.	SIZE	CTN QTY
C76850	1/4"	5
C76851	3/8"	5
C76852	1/2"	5

Plug CTS



PART NO.	SIZE	CTN QTY
C76853	1/4"	5
C76854	3/8"	5
C76855	1/2"	5

Union & Reducing Union CTS x CTS



PART NO.	SIZE	CTN QTY
C76856	1/4"	5
C76857	3/8" x 1/4"	5
C76858	3/8" x 3/8"	5
C76859	1/2" x 3/8"	5

Bulkhead Union CTS x CTS



PART NO.	SIZE	CTN QTY
C76860	1/4" x 1/4"	5
C76861	3/8" x 3/8"	5
C76862	1/2" x 3/8"	5

Tee & Reducing Tee CTS x CTS x CTS



PART NO.	SIZE	CTN QTY
C76863	1/4"	5
C76864	3/8" x 3/8" x 1/4"	5
C76865	3/8"	5
C76866	1/2" x 1/2" x 3/8"	5
C76867	1/2"	5

Elbow CTS x MIP



PART NO.	SIZE	CTN QTY
C76884	1/4" x 1/8"	5
C76885	1/4" x 1/4"	5
C76886	1/4" x 3/8"	5
C76887	3/8" x 1/4"	5
C76888	3/8" x 3/8"	5

Elbow & Reducing Elbow CTS x CTS



PART NO.	SIZE	CTN QTY
C76868	1/4"	5
C76869	3/8"	5
C76870	1/2"	5

Elbow Adapter CTS x CTS Stem



PART NO.	SIZE	CTN QTY
C76889	1/4" x 1/4"	5
C76890	3/8" x 3/8"	5

Coupling CTS x FIP



PART NO.	SIZE	CTN QTY
C76871	1/4" x 1/8"	5
C76872	1/4" x 1/4"	5
C76873	3/8" x 1/4"	5

Connector CTS Stem x Tube ID



PART NO.	SIZE	CTN QTY
C76891	3/8" x 3/8"	5
C76892	3/8" x 1/2"	5
C76893	1/2" x 1/2"	5

Kitchen Faucet Adapter Tee FIP x MIP x CTS



PART NO.	SIZE	CTN QTY
C76874	1/2" x 1/2" x 1/4"	5
C76875	1/2" x 1/2" x 3/8"	5

Connector CTS x MIP



PART NO.	SIZE	CTN QTY
C76876	1/4" x 1/8"	5
C76877	1/4" x 1/4"	5
C76878	1/4" x 3/8"	5
C76879	3/8" x 1/4"	5
C76880	3/8" x 3/8"	5
C76881	3/8" x 1/2"	5
C76882	1/2" x 3/8"	5
C76883	1/2" x 1/2"	5

Red Brass Pipe Nipples

Now Lead Free
Meets ASTM B687



PART NO.	IPT
N20000	1/8"x close
N20001	1/8"x 1 1/2"
N20002	1/8"x 2"
N20003	1/8"x 2 1/2"
N20004	1/8"x 3"
N20005	1/8"x 3 1/2"
N20006	1/8"x 4"
N20007	1/8"x 4 1/2"
N20008	1/8"x 5"
N20009	1/8"x 5 1/2"
N20010	1/8"x 6"
N20012	1/8"x 7"
N20014	1/8"x 8"
N20016	1/8"x 9"
N20018	1/8"x 10"
N20020	1/8"x 11"
N20022	1/8"x 12"
N21000	1/4"x close
N21001	1/4"x 1 1/2"
N21002	1/4"x 2"
N21003	1/4"x 2 1/2"
N21004	1/4"x 3"
N21005	1/4"x 3 1/2"
N21006	1/4"x 4"
N21007	1/4"x 4 1/2"
N21008	1/4"x 5"
N21009	1/4"x 5 1/2"
N21010	1/4"x 6"
N21012	1/4"x 7"
N21014	1/4"x 8"
N21016	1/4"x 9"
N21018	1/4"x 10"
N21020	1/4"x 11"
N21022	1/4"x 12"
N22000	3/8"x close
N22001	3/8"x 1 1/2"
N22002	3/8"x 2"
N22003	3/8"x 2 1/2"
N22004	3/8"x 3"
N22005	3/8"x 3 1/2"
N22006	3/8"x 4"
N22007	3/8"x 4 1/2"
N22008	3/8"x 5"
N22009	3/8"x 5 1/2"
N22010	3/8"x 6"
N22012	3/8"x 7"
N22014	3/8"x 8"
N22016	3/8"x 9"
N22018	3/8"x 10"

Red Brass Pipe Nipples cont...

PART NO.	IPT
N22020	3/8"x 11"
N22022	3/8"x 12"
N23000	1/2"x close
N23001	1/2"x 1 1/2"
N23002	1/2"x 2"
N23003	1/2"x 2 1/2"
N23004	1/2"x 3"
N23005	1/2"x 3 1/2"
N23006	1/2"x 4"
N23007	1/2"x 4 1/2"
N23008	1/2"x 5"
N23009	1/2"x 5 1/2"
N23010	1/2"x 6"
N23012	1/2"x 7"
N23014	1/2"x 8"
N23016	1/2"x 9"
N23018	1/2"x 10"
N23020	1/2"x 11"
N23022	1/2"x 12"
N24000	3/4"x close
N24001	3/4"x 1 1/2"
N24002	3/4"x 2"
N24003	3/4"x 2 1/2"
N24004	3/4"x 3"
N24005	3/4"x 3 1/2"
N24006	3/4"x 4"
N24007	3/4"x 4 1/2"
N24008	3/4"x 5"
N24009	3/4"x 5 1/2"
N24010	3/4"x 6"
N24012	3/4"x 7"
N24014	3/4"x 8"
N24016	3/4"x 9"
N24018	3/4"x 10"
N24020	3/4"x 11"
N24022	3/4"x 12"
N25000	1"x close
N25002	1"x 2"
N25003	1"x 2 1/2"
N25004	1"x 3"
N25005	1"x 3 1/2"
N25006	1"x 4"
N25007	1"x 4 1/2"
N25008	1"x 5"
N25009	1"x 5 1/2"
N25010	1"x 6"
N25012	1"x 7"
N25014	1"x 8"
N25016	1"x 9"
N25018	1"x 10"
N25020	1"x 11"

Red Brass Pipe Nipples cont...

PART NO.	IPT
N25022	1"x 12"
N27000	1 1/4"x close
N27002	1 1/4"x 2"
N27003	1 1/4"x 2 1/2"
N27004	1 1/4"x 3"
N27005	1 1/4"x 3 1/2"
N27006	1 1/4"x 4"
N27007	1 1/4"x 4 1/2"
N27008	1 1/4"x 5"
N27009	1 1/4"x 5 1/2"
N27010	1 1/4"x 6"
N27012	1 1/4"x 7"
N27014	1 1/4"x 8"
N27016	1 1/4"x 9"
N27018	1 1/4"x 10"
N27020	1 1/4"x 11"
N27022	1 1/4"x 12"
N28000	1 1/2"x close
N28002	1 1/2"x 2"
N28003	1 1/2"x 2 1/2"
N28004	1 1/2"x 3"
N28005	1 1/2"x 3 1/2"
N28006	1 1/2"x 4"
N28007	1 1/2"x 4 1/2"
N28008	1 1/2"x 5"
N28009	1 1/2"x 5 1/2"
N28010	1 1/2"x 6"
N28012	1 1/2"x 7"
N28014	1 1/2"x 8"
N28016	1 1/2"x 9"
N28018	1 1/2"x 10"
N28020	1 1/2"x 11"
N28022	1 1/2"x 12"
N29000	2"x close
N29003	2"x 2 1/2"
N29004	2"x 3"
N29005	2"x 3 1/2"
N29006	2"x 4"
N29007	2"x 4 1/2"
N29008	2"x 5"
N29009	2"x 5 1/2"
N29010	2"x 6"
N29012	2"x 7"
N29014	2"x 8"

Red Brass Pipe Nipples cont...

PART NO.	IPT
N29016	2"x 9"
N29018	2"x 10"
N29020	2"x 11"
N29022	2"x 12"
N30000	2 1/2" x close
N30004	2 1/2"x 3"
N30005	2 1/2"x 3 1/2"
N30006	2 1/2"x 4"
N30007	2 1/2"x 4 1/2"
N30008	2 1/2"x 5"
N30009	2 1/2"x 5 1/2"
N30010	2 1/2"x 6"
N31000	3"x close
N31004	3"x 3"
N31005	3"x 3 1/2"
N31006	3"x 4"
N31007	3"x 4 1/2"
N31008	3"x 5"
N31009	3"x 5 1/2"
N31010	3"x 6"

90° Elbow



PART NO.	SIZE
B74001	1/8"
B74002	1/4"
B74003	3/8"
B74004	1/2"
B74005	3/4"
B74006	1"
B74007	1-1/4"
B74008	1-1/2"
B74009	2"
B74010	2-1/2"
B74011	3"
B74012	4"
B74340	3/8" x 1/4"
B74341	1/2" x 1/4"
B74342	1/2" x 3/8"
B74343	3/4" x 1/2"
B74344	1" x 1/2"
B74345	1" x 3/4"
B74346	1-1/4" x 1"
B74347	1-1/2" x 1-1/4"
B74348	2" x 1-1/2"
B74386	3/4" x 1/4"
B74387	3/4" x 3/8"
B74388	1-1/4" x 1/2"
B74389	1-1/4" x 3/4"
B74390	1-1/2" x 3/4"
B74391	1-1/2" x 1"

90° Street Elbow



PART NO.	SIZE
B74021	1/8"
B74022	1/4"
B74023	3/8"
B74024	1/2"
B74025	3/4"
B74026	1"
B74027	1-1/4"
B74028	1-1/2"
B74029	2"
B74030	2-1/2"
B74031	3"
B74032	4"

SPECIFICATIONS:

ANSI B16.15
ANSI B2.1 (PIPE THREADS)
FED WW-P-460
FED WW-U-516
150 PSI @400°F WSP
225 PSI WOG@ -20°F / 150°F

45° Elbow



PART NO.	SIZE
B74041	1/8"
B74042	1/4"
B74043	3/8"
B74044	1/2"
B74045	3/4"
B74046	1"
B74047	1-1/4"
B74048	1-1/2"
B74049	2"
B74050	2-1/2"
B74051	3"
B74052	4"

45° Street Elbow



PART NO.	SIZE
B74061	1/8"
B74062	1/4"
B74063	3/8"
B74064	1/2"
B74065	3/4"
B74066	1"
B74067	1-1/4"
B74068	1-1/2"
B74069	2"

Union



PART NO.	SIZE
B74261	1/8"
B74262	1/4"
B74263	3/8"
B74264	1/2"
B74265	3/4"
B74266	1"
B74267	1-1/4"
B74268	1-1/2"
B74269	2"
B74270	2-1/2"
B74271	3"
B74272	4"

Bronze Locknuts



PART NO.	SIZE
B74380	1/2"
B74381	3/4"
B74382	1"
B74383	1-1/4"
B74384	1-1/2"
B74385	2"

Tee



PART NO.	SIZE
B74081	1/8"
B74082	1/4"
B74083	3/8"
B74084	1/2"
B74085	3/4"
B74086	1"
B74087	1-1/4"
B74088	1-1/2"
B74089	2"
B74090	2-1/2"
B74091	3"
B74092	4"
B74354	1/2" x 3/8"
B74355	3/4" x 1/4"
B74356	3/4" x 3/8"
B74357	3/4" x 1/2" x 1/2"
B74358	3/4" x 1/2" x 3/4"
B74359	3/4" x 1/2"
B74360	1" x 1/2" x 1/2"
B74361	1" x 1/2" x 1"
B74362	1" x 1/2"
B74363	1" x 3/4" x 3/4"
B74364	1" x 3/4" x 1"
B74365	1" x 3/4"
B74369	1-1/4" x 3/4"
B74366	1-1/4" x 1"
B74367	1-1/2" x 1-1/4"
B74368	2" x 1-1/2"
B74392	3/8" x 1/4"
B74393	1/2" x 3/8" x 1/2"
B74394	1/2" x 1/2" x 3/4"
B74397	1-1/2" x 1"

Cap



PART NO.	SIZE
B74181	1/8"
B74182	1/4"
B74183	3/8"
B74184	1/2"
B74185	3/4"
B74186	1"
B74187	1-1/4"
B74188	1-1/2"
B74189	2"
B74190	2-1/2"
B74191	3"
B74192	4"

Coupling/ Reducer



PART NO.	SIZE
B74121	1/8"
B74122	1/4"
B74123	3/8"
B74124	1/2"
B74125	3/4"
B74126	1"
B74127	1-1/4"
B74128	1-1/2"
B74129	2"
B74130	2-1/2"
B74131	3"
B74132	4"
B74140	1/4" x 1/8"
B74141	3/8" x 1/8"
B74142	3/8" x 1/4"
B74143	1/2" x 1/8"
B74144	1/2" x 1/4"
B74145	1/2" x 3/8"
B74146	3/4" x 1/4"
B74147	3/4" x 3/8"
B74148	3/4" x 1/2"
B74149	1" x 1/2"
B74150	1" x 3/4"
B74151	1-1/4" x 1/2"
B74152	1-1/4" x 3/4"
B74153	1-1/4" x 1"
B74154	1-1/2" x 1/2"
B74155	1-1/2" x 3/4"
B74156	1-1/2" x 1"
B74157	1-1/2" x 1-1/4"
B74158	2" x 3/4"
B74159	2" x 1"
B74160	2" x 1-1/4"
B74161	2" x 1-1/2"
B74162	2-1/2" x 2"
B74163	3" x 2"
B74164	4" x 3"

Extension Piece



PART NO.	SIZE
B74370	3/4" Extension piece
B74400	1/2" Extension piece

Corded Square Head Plug



PART NO.	SIZE
B74284	1/2"
B74285	3/4"
B74286	1"
B74287	1-1/4"
B74288	1-1/2"
B74289	2"
B74290	2-1/2"
B74291	3"
B74292	4"

Solid Square Head Plug



PART NO.	SIZE
B74301	1/8"
B74302	1/4"
B74303	3/8"
B74304	1/2"
B74305	3/4"
B74306	1"
B74307	1-1/4"
B74308	1-1/2"
B74309	2"
B74310	2-1/2"
B74311	3"
B74312	4"

Countersunk Plug



PART NO.	SIZE
B74321	1/8"
B74322	1/4"
B74323	3/8"
B74324	1/2"
B74325	3/4"
B74326	1"
B74327	1-1/4"
B74328	1-1/2"
B74329	2"
B74330	2-1/2"
B74331	3"
B74332	4"

Cross



PART NO.	SIZE
B74101	1/8"
B74102	1/4"
B74103	3/8"
B74104	1/2"
B74105	3/4"
B74106	1"
B74107	1-1/4"
B74108	1-1/2"
B74109	2"

HEX Brushing



PART NO.	SIZE
B74200	1/4" x 1/8"
B74201	3/8" x 1/8"
B74202	3/8" x 1/4"
B74203	1/2" x 1/8"
B74204	1/2" x 1/4"
B74205	1/2" x 3/8"
B74206	3/4" x 1/8"
B74207	3/4" x 1/4"
B74208	3/4" x 3/8"
B74209	3/4" x 1/2"
B74210	1" x 1/4"
B74211	1" x 3/8"
B74212	1" x 1/2"
B74213	1" x 3/4"
B74214	1-1/4" x 1/4"
B74215	1-1/4" x 3/8"
B74216	1-1/4" x 1/2"
B74217	1-1/4" x 3/4"
B74218	1-1/4" x 1"
B74219	1-1/2" x 1/4"
B74220	1-1/2" x 3/8"
B74221	1-1/2" x 1/2"
B74222	1-1/2" x 3/4"
B74223	1-1/2" x 1"
B74224	1-1/2" x 1-1/4"
B74225	2" x 1/4"
B74226	2" x 3/8"
B74227	2" x 1/2"
B74228	2" x 3/4"
B74229	2" x 1"
B74230	2" x 1-1/4"
B74231	2" x 1-1/2"
B74232	2-1/2" x 2"
B74233	3" x 2"
B74234	3" x 2-1/2"
B74235	4" x 3"

Chrome Plated Nipples & Pipe Lengths



PART NO.	SIZE
N15100	3/8" x close
N15150	3/8" x 1-1/2"
N15200	3/8" x 2"
N15250	3/8" x 2-1/2"
N15300	3/8" x 3"
N15350	3/8" x 3-1/2"
N15400	3/8" x 4"
N15450	3/8" x 4-1/2"
N15500	3/8" x 5"
N15550	3/8" x 5-1/2"
N15600	3/8" x 6"
N15900	3/8" x 12"
N15918	3/8" x 18"
N15924	3/8" x 24"
N15936	3/8" x 36"
N15948	3/8" x 48"
N15960	3/8" x 60"
N15972	3/8" x 72"
N16100	1/2" x close
N16150	1/2" x 1-1/2"
N16200	1/2" x 2"
N16250	1/2" x 2-1/2"
N16300	1/2" x 3"
N16350	1/2" x 3-1/2"
N16400	1/2" x 4"
N16450	1/2" x 4-1/2"
N16500	1/2" x 5"
N16550	1/2" x 5-1/2"
N16600	1/2" x 6"
N16900	1/2" x 12"
N16918	1/2" x 18"
N16924	1/2" x 24"
N16936	1/2" x 36"
N16948	1/2" x 48"
N16960	1/2" x 60"
N16972	1/2" x 72"
N17100	3/4" x close
N17150	3/4" x 1-1/2"
N17200	3/4" x 2"
N17250	3/4" x 2-1/2"
N17300	3/4" x 3"
N17350	3/4" x 3-1/2"
N17400	3/4" x 4"
N17450	3/4" x 4-1/2"
N17500	3/4" x 5"
N17550	3/4" x 5-1/2"
N17600	3/4" x 6"
N18100	1" x close
N18200	1" x 2"
N18250	1" x 2-1/2"
N18300	1" x 3"
N18400	1" x 4"
N18500	1" x 5"
N18600	1" x 6"

90° Elbow



PART NO.	SIZE
B50001	3/8"
B50002	1/2"
B50003	3/4"
B50004	1"

90° Street Elbow



PART NO.	SIZE
B50093	3/8"
B50094	1/2"
B50098	3/4"
B50103	1"

45° Elbow



PART NO.	SIZE
B50011	3/8"
B50012	1/2"
B50013	3/4"
B50014	1"

Tee



PART NO.	SIZE
B50031	3/8"
B50032	1/2"
B50033	3/4"
B50034	1"

Coupling



PART NO.	SIZE
B50041	3/8"
B50042	1/2"
B50043	3/4"
B50044	1"

Reducer



PART NO.	SIZE
B50051	1/2" x 3/8"
B50052	3/4" x 1/2"

Bushing



PART NO.	SIZE
B50072	1/2" x 3/8"
B50073	3/4" x 1/2"
B50074	1" x 1/2"
B50075	1" x 3/4"

Union

PART NO.	SIZE
B50091	3/8"
B50092	1/2"
B50097	3/4"
B50100	1"

Plug

PART NO.	SIZE
B50095	3/8"
B50096	1/2"
B50099	3/4"
B50101	1"

Cap

PART NO.	SIZE
B50081	3/8"
B50082	1/2"
B50083	3/4"
B50084	1"

Male Hose To Male Pipe



PART NO.	MHT x MPT	CTN. QTY.
G20002	3/4" x 1/2"	10
G20003	3/4" x 3/4" (1/2" FIP tap)	10
G20004	3/4" x 1/2" (1/2" swt)	10
Lead Free		
G20102	3/4" x 1/2"	10
G20103	3/4" x 3/4" (1/2" FIP tap)	10

Female Hose To Female Pipe



PART NO.	FHT x FPT	CTN. QTY.
G20020	3/4" x 1/2"	10
G20021	3/4" x 3/4"	10
Lead Free		
G20120	3/4" x 1/2"	10
G20121	3/4" x 3/4"	10

Male Hose To Male Hose



PART NO.	MHT x MHT	CTN. QTY.
G20008	3/4" x 3/4" (1/2" FIP tap)	10
Lead Free		
G20108	3/4" x 3/4" (1/2" FIP tap)	11

Female Hose To Female Hose Swivel



PART NO.	FHT x FHT	CTN. QTY.
G20030	3/4" x 3/4"	10
Lead Free		
G20130	3/4" x 3/4"	10

Male Hose To Female Hose



PART NO.	MHT x FPT	CTN. QTY.
G20010	3/4" x 1/2"	10
G20011	3/4" x 3/4"	10
Lead Free		
G20110	3/4" x 1/2"	10
G20111	3/4" x 3/4"	10

Female Hose To Female Pipe Swivel



PART NO.	FHT x FPT	CTN. QTY.
G20031	3/4" x 1/2"	10
G20032	3/4" x 3/4"	10
Lead Free		
G20131		10
G20132		10

Female Hose To Male Pipe



PART NO.	MHT x FPT	CTN. QTY.
G20005	3/4" x 1/2" (1/2" SWT)	10
G20015	3/4" x 1/2"	10
G20016	3/4" x 3/4"	10
G20017	3/4" x 3/4" (1/2" FIP tap)	10
Lead Free		
G20115	3/4" x 1/2"	10
G20116	3/4" x 3/4"	10

Hose Barb To Female Hose Swivel



PART NO.	HB x FHT	CTN. QTY.
G20035	3/8" x 3/4"	10
G20036	1/2" x 3/4"	10
G20037	5/8" x 3/4"	10
G20038	3/4" x 3/4"	10
Lead Free		
G20136	1/2" x 3/4"	10
G20137	5/8" x 3/4"	10
G20138	3/4" x 3/4"	10

Hose Barb To Male Hose



PART NO.	HB x MHT	CTN. QTY.
G20040	3/8" x 3/4"	10
G20041	1/2" x 3/4"	10
G20042	5/8" x 3/4"	10
G20043	3/4" x 3/4"	10
Lead Free		
G20141	1/2" x 3/4"	10
G20142	5/8" x 3/4"	10
G20143	3/4" x 3/4"	10

Garden Hose Cap



PART NO.	FHT	CTN. QTY.
G20055	3/4"	10
G20056	3/4" with chain	10
Lead Free		
G20155	3/4" with washer	11

Male Pipe To Female Hose Swivel



PART NO.	MPT x FHT	CTN. QTY.
G20045	1/4" x 3/4"	10
G20047	1/2" x 3/4"	10

Garden Hose Washer



PART NO.	SIZE	CTN. QTY.
G20057	3/4" vinyl	100
G20057R	3/4" rubber	100

Hose WYE



PART NO.	DESCRIPTION	CTN. QTY.
G20050	3/4" x 3/4"	10
Lead Free		
G20150	3/4" X 3/4"	11

Garden Hose Filter Washer



PART NO.	SIZE	CTN. QTY.
G20060	3/4"	500

Garden Hose Shut Off



• Buna-N seals

PART NO.	DESCRIPTION	CTN. QTY.
G20051	Dual shut off/green ABS	10
G20052	Single shut off/green ABS	10
G20053	Brass hose with shut off "y"	20
G20054	CP die cast with shut off "y"	20

Evaporation Cooler Drain



PART NO.	MHT x FPT	CTN. QTY.
G20006	3/4" x 1/2"	10

Hose Barb To Male Pipe

• Barb refers to hose I.D.



PART NO.	BARB x MPT	CTN. QTY.
G25022	1/8" x 1/8"	10
G25032	3/16" x 1/8"	10
G25034	3/16" x 1/4"	10
G25042	1/4" x 1/8"	10
G25044	1/4" x 1/4"	10
G25046	1/4" x 3/8"	10
G25048	1/4" x 1/2"	10
G25052	5/16" x 1/8"	10
G25054	5/16" x 1/4"	10
G25056	5/16" x 3/8"	10
G25062	3/8" x 1/8"	10
G25064	3/8" x 1/4"	10
G25066	3/8" x 3/8"	10
G25068	3/8" x 1/2"	10
G25612	3/8" x 3/4"	10
G25084	1/2" x 1/4"	10
G25086	1/2" x 3/8"	10
G25088	1/2" x 1/2"	10
G25812	1/2" x 3/4"	10
G25106	5/8" x 3/8"	10
G25108	5/8" x 1/2"	10
G25101	5/8" x 3/4"	10
G25128	3/4" x 1/2"	10
G25121	3/4" x 3/4"	10
G25161	1" x 3/4"	10
G25169	1" x 1"	10

Hose Barb To Female Pipe

• Barb refers to hose I.D.



PART NO.	BARB x FPT	CTN. QTY.
G26022	1/8" x 1/8"	10
G26032	3/16" x 1/8"	10
G26034	3/16" x 1/4"	10
G26042	1/4" x 1/8"	10
G26044	1/4" x 1/4"	10
G26046	1/4" x 3/8"	10
G26052	5/16" x 1/8"	10
G26054	5/16" x 1/4"	10
G26056	5/16" x 3/8"	10
G26062	3/8" x 1/8"	10
G26064	3/8" x 1/4"	10
G26066	3/8" x 3/8"	10
G26068	3/8" x 1/2"	10
G26084	1/2" x 1/4"	10
G26086	1/2" x 3/8"	10
G26088	1/2" x 1/2"	10
G26121	3/4" x 3/4"	10
G26161	1" x 3/4"	10

Barb To Barb Hose Splicers



PART NO.	BARB	CTN. QTY.
G29003	3/16"	10
G29004	1/4"	10
G29005	5/16"	10
G29006	3/8"	10
G29008	1/2"	10
G29010	5/8"	10

Hose Barb To Male Pipe Elbow



PART NO.	BARB x MPT	CTN. QTY.
G27042	1/4" x 1/8"	10
G27044	1/4" x 1/4"	10
G27054	5/16" x 1/4"	10
G27062	3/8" x 1/8"	10
G27064	3/8" x 1/4"	10
G27066	3/8" x 3/8"	10
G27068	3/8" x 1/2"	10
G27084	1/2" x 1/4"	10
G27086	1/2" x 3/8"	10
G27088	1/2" x 1/2"	10
G27106	5/8" x 3/8"	10
G27108	5/8" x 1/2"	10

Hose Barb To Female Ball End Swivel



PART NO.	BARB x NPSM	CTN. QTY.
G28044	1/4" x 1/4"	10
G28066	3/8" x 3/8"	10
G28088	1/2" x 1/2"	10

Hose Barb Tee



PART NO.	BARB x MPT	CTN. QTY.
G24004	1/4"	10
G24006	3/8"	10

Nylon Hose Barb Splicer



PART NO.	BARB x BARB	CTN. QTY.
N10001	1/8" x 1/8"	10
N10002	1/4" x 1/4"	10
N10003	5/16" x 5/16"	10
N10004	3/8" x 3/8"	10
N10005	1/2" x 1/2"	10
N10006	5/8" x 5/8"	10
N10007	3/4" x 3/4"	10
N10008	1" x 1"	5

Nylon Hose Barb Tees



PART NO.	BARB x BARB	CTN. QTY.
N11001	1/8" x 1/8" x 1/8"	10
N11002	1/4" x 1/4" x 1/4"	10
N11003	3/8" x 3/8" x 3/8"	10
N11004	1/2" x 1/2" x 3/8"	10
N11005	1/2" x 1/2" x 1/2"	10
N11006	5/8" x 5/8" x 5/8"	10
N11007	3/4" x 3/4" x 3/4"	10
N11008	1" x 1" x 1"	5

Nylon Hose Barb Elbows



PART NO.	BARB x BARB	CTN. QTY.
N12001	1/4" x 1/4"	10
N12002	3/8" x 3/8"	10
N12003	1/2" x 1/2"	10
N12004	5/8" x 5/8"	10
N12005	3/4" x 3/4"	10
N12006	1" x 1"	5

Nylon Garden Hose Cap



PART NO.	FHT	CTN. QTY.
N06001	3/4"	10

Nylon Female Hose Barb Adapter



PART NO.	BARB x FPT	CTN. QTY.
N15001	1/2" x 1/2"	10

Nylon Hose Barb Adapter



PART NO.	MPT x BARB	CTN. QTY.
N14001	1/4" x 1/4"	10
N14002	1/4" x 3/8"	10
N14003	3/8" x 1/4"	10
N14004	3/8" x 3/8"	10
N14005	3/8" x 1/2"	10
N14006	1/2" x 1/4"	10
N14007	1/2" x 3/8"	10
N14008	1/2" x 1/2"	10
N14009	1/2" x 5/8"	10
N14010	1/2" x 3/4"	10
N14011	3/4" x 3/8"	10
N14012	3/4" x 1/2"	10
N14013	3/4" x 5/8"	10
N14014	3/4" x 3/4"	10
N14015	3/4" x 1"	5
N14016	1" x 1/2"	5
N14017	1" x 5/8"	5
N14018	1" x 3/4"	5
N14019	1" x 1"	5

Nylon Male Garden Hose To Female Pipe



PART NO.	MHT x FPT	CTN. QTY.
N18001	3/4" x 1/2"	10
N18002	3/4" x 3/4"	10

Nylon Male Garden Hose To Male Pipe



PART NO.	MHT x MPT	CTN. QTY.
N09001	3/4" x 1/2"	10
N09002	3/4" x 3/4"	10

Nylon Female Garden Hose To Female Pipe



PART NO.	FHT x FPT	CTN. QTY.
N07001	3/4" x 1/2"	10

Male Insert Adapter



- NSF certified
- For flexible polyethylene plastic pipe

PART NO.	SIZE	CTN. QTY.
I11001	1/2"	10
I11002	3/4"	10
I11003	1"	10
I11004	1 1/4"	10
I11005	1 1/2"	10
I11006	2"	10

Insert Combination Elbow



- NSF certified
- For flexible polyethylene plastic pipe

PART NO.	SIZE	CTN. QTY.
I11025	1/2"	10
I11026	3/4"	10
I11027	1"	10
I11028	1 1/4"	10

Insert Coupling



- NSF certified
- For flexible polyethylene plastic pipe

PART NO.	SIZE	CTN. QTY.
I11007	1/2"	10
I11008	3/4"	10
I11009	1"	10
I11010	1 1/4"	10
I11011	1 1/2"	10
I11012	2"	10

Insert Elbow



- NSF certified
- For flexible polyethylene plastic pipe

PART NO.	SIZE	CTN. QTY.
I11013	1/2"	10
I11014	3/4"	10
I11015	1"	10
I11016	1 1/4"	10
I11017	1 1/2"	10
I11018	2"	5

Insert Tee



- NSF certified
- For flexible polyethylene plastic pipe

PART NO.	SIZE	CTN. QTY.
I11019	1/2"	10
I11020	3/4"	10
I11021	1"	10
I11022	1 1/4"	10
I11023	1 1/2"	10
I11024	2"	5

Male Insert Adapter



- NSF approved
- For flexible polyethylene plastic pipe

PART NO.	SIZE	CTN. QTY.
I10001	1/2"	10
I10002	3/4"	10
I10003	1"	10
I10004	1-1/4"	10
I10005	1-1/2"	10
I10006	2"	10

Insert Elbow



- NSF approved
- For flexible polyethylene plastic pipe

PART NO.	SIZE	CTN. QTY.
I10023	1/2"	10
I10024	3/4"	10
I10025	1"	10
I10026	1-1/4"	10
I10027	1-1/2"	10
I10028	2"	5

Female Insert Adapter



- NSF approved
- For flexible polyethylene plastic pipe

PART NO.	SIZE	CTN. QTY.
I10007	1/2"	10
I10008	3/4"	10
I10009	1"	10
I10010	1-1/4"	10

Insert Tee



- NSF approved
- For flexible polyethylene plastic pipe

PART NO.	SIZE	CTN. QTY.
I10029	1/2"	10
I10030	3/4"	10
I10031	1"	10
I10032	1-1/4"	10
I10033	1-1/2"	10
I10034	2"	5

Insert Coupling



- NSF approved
- For flexible polyethylene plastic pipe

PART NO.	SIZE	CTN. QTY.
I10011	1/2"	10
I10012	3/4"	10
I10013	1"	10
I10014	1-1/4"	10
I10015	1-1/2"	10
I10016	2"	10

Insert x MIP Combination Elbow



- NSF approved
- For flexible polyethylene plastic pipe

PART NO.	SIZE	CTN. QTY.
I10035	1/2"	10
I10036	3/4"	10
I10037	1"	10
I10038	1-1/4"	10
I10039	1-1/2"	10

Reducing Insert Coupling



- NSF approved
- For flexible polyethylene plastic pipe

PART NO.	SIZE	CTN. QTY.
I10017	3/4" x 1/2"	10
I10018	1" x 1/2"	10
I10019	1" x 3/4"	10
I10020	1-1/4" x 1"	10
I10021	1-1/2" x 1-1/4"	5
I10022	2" x 1-1/2"	5

Insert Reducing Tee



- NSF approved
- For flexible polyethylene plastic pipe

PART NO.	SIZE	CTN. QTY.
I10043	3/4" x 3/4" x 1/2"	10
I10044	3/4" x 1/2" x 1/2"	10
I10045	1" x 1" x 1/2"	10
I10046	1" x 1" x 3/4"	10
I10047	1" x 3/4" x 3/4"	10
I10048	1-1/2" x 1-1/2" x 1"	10
I10049	2" x 2" x 1"	5

Male Insert Reducer



- NSF approved
- For flexible polyethylene plastic pipe

PART NO.	SIZE	CTN. QTY.
I10040	3/4" x 1/2"	10
I10041	1" x 3/4"	10
I10042	1-1/4" x 1"	10

Male Insert Adapter



• For flexible polyethylene plastic pipe

PART NO.	SIZE	CTN. QTY.
I13001	1/2"	10
I13002	3/4"	10
I13003	1"	10
I13004	1 1/4"	10
I13005	1 1/2"	10
I13006	2"	10

Male Insert Reducer



• For flexible polyethylene plastic pipe

PART NO.	INSERT x MPT	CTN. QTY.
I13007	1" x 3/4"	10
I13008	1-1/4" x 1"	10
I13030	1" x 1 1/4"	10

Female Insert Adapter



• For flexible polyethylene plastic pipe

PART NO.	SIZE	CTN. QTY.
I13009	1/2"	10
I13010	3/4"	10
I13011	1"	10
I13012	1 1/4"	10
I13013	1 1/2"	10
I13014	2"	10

Insert x MIP 90° Elbow



• For flexible polyethylene plastic pipe

PART NO.	INSERT	MIP	CTN. QTY.
I13031	3/4"	3/4"	10
I13032	1"	3/4"	10
I13033	1"	1"	10
I13034	1 1/4"	1 1/4"	10

Insert x Sweat Adapters



• For flexible polyethylene plastic pipe

PART NO.	INSERT	SWEAT	CTN. QTY.
I13035	1/2"	1/2"	10
I13036	3/4"	3/4"	10
I13037	1"	1"	10
I13038	1 1/4"	1-1/4"	10

Insert x FIP Tee



• For flexible polyethylene plastic pipe

PART NO.	INSERT x FIP TEE	CTN. QTY.
I13039	1/2"x 1/2"	10
I13040	3/4"x 3/4"	10
I13041	1" x 1"	10
I13042	1 1/4"x 1 1/4"	10

Insert Coupling



• For flexible polyethylene plastic pipe

PART NO.	SIZE	CTN. QTY.
I13015	1/2"	10
I13016	3/4"	10
I13017	1"	10
I13018	1 1/4"	10
I13019	1 1/2"	10
I13020	2"	10

Insert Tee



• For flexible polyethylene plastic pipe

PART NO.	SIZE	CTN. QTY.
I13021	3/4"	10
I13022	1"	10
I13023	1 1/4"	10

Insert Elbow



• For flexible polyethylene plastic pipe

PART NO.	SIZE	CTN. QTY.
I13024	3/4"	10
I13025	1"	10
I13026	1 1/4"	10

Insert Male Rope Adapter



• For flexible polyethylene plastic pipe

PART NO.	SIZE	CTN. QTY.
I13027	1"	10
I13028	1 1/4"	10
I13029	1" x 1 1/4"	10

Steel Male Insert Adapter



• For flexible polyethylene plastic pipe

PART NO.	SIZE	CTN. QTY.
I12001	1/2"	10
I12002	3/4"	10
I12003	1"	10
I12004	1-1/4"	10
I12005	1-1/2"	10
I12006	2"	10

INSERT FITTINGS VS HOSE BARBS?

Insert Fittings only fit polyethylene plastic pipe (water service pipe).

Hose Barbs are designed to fit the inside diameter of various rubber hose sizes.

Both types of fittings are normally secured with hose gear clamps.

Steel Female Insert Adapter



• For flexible polyethylene plastic pipe

PART NO.	SIZE	CTN. QTY.
I12007	1/2"	10
I12008	3/4"	10
I12009	1"	10
I12010	1-1/4"	10
I12011	1-1/2"	10
I12012	2"	10

Steel Insert Coupling



• For flexible polyethylene plastic pipe

PART NO.	SIZE	CTN. QTY.
I12013	1/2"	10
I12014	3/4"	10
I12015	1"	10
I12016	1-1/4"	10
I12017	1-1/2"	10
I12018	2"	10

Angle Needle Valve



PART NO.	FLARE x MIP
N10142	1/4" x 1/8"
N10164	3/8" x 1/4"

Straight Needle Valve



PART NO.	FLARE x FLARE
N10244	1/4" x 1/4"
N10266	3/8" x 3/8"

Straight Needle Valve



PART NO.	FLARE x MIP
N10342	1/4" x 1/8"
N10344	1/4" x 1/4"
N10364	3/8" x 1/4"

Angle Compression Needle Valve



PART NO.	COMP x MIP
N10442	1/4" x 1/8"
N10444	1/4" x 1/4"
N10464	3/8" x 1/4"

Straight Compression Needle Valve



PART NO.	COMP x COMP
N10544	1/4" x 1/4"
N10566	3/8" x 3/8"

Straight Compression Needle Valve



PART NO.	COMP x MIP
N10642	1/4" x 1/8"
N10644	1/4" x 1/4"
N10664	3/8" x 1/4"

Pipe Needle Valves



PART NO.	MIP x MIP
N10722	1/8" x 1/8"
N10744	1/4" x 1/4"

Pipe Needle Valves



PART NO.	MIP x FIP
N10822	1/8" x 1/8"
N10844	1/4" x 1/4"

Pipe Needle Valves



PART NO.	FIP x FIP
N10922	1/8" x 1/8"
N10944	1/4" x 1/4"

Needle Valve Tee Kit



PART NO.	COMP x COMP
N78064	3/8" x 1/4"
N78084	1/2" x 1/4"
N78104	5/8" x 1/4"

Brass Saddle Clamp



- Fits up to 3/4" iron pipe
- Fits up to 1" hard copper
- Unassembled

PART NO.	FPT
N01038	1/8"

Brass Saddle Clamp With Valve



- Fits up to 3/4" iron pipe
- Fits up to 1" hard copper
- Unassembled

PART NO.	OD
N01039	1/4"

Self Piercing Valve



- 1/4" OD compression outlet
- Fits 3/8" to 1.315" OD tube

PART NO.	TUBE SIZE
S92001	1/4"

Icemaker Or Humidifier Kit



- 1/4" tubing
- Self piercing valve
- Brass fittings



PART NO.	TUBE SIZE
S92025	1/4" x 25' poly tubing
S92030	1/4" x 25' copper tubing
S92031	1/4" x 15' poly tubing

Gas Shut-Off Valve

MADE IN THE
USA

- Rated at 2 PSIG
- Cast bronze plug style



Lever Handle		
G17025	1/4"	25
G17037	3/8"	25
G17050	1/2"	50
G17075	3/4"	50
G17100	1"	25
G17125	1-1/4"	10
G17150	1-1/2"	10
G17200	2"	5



Square Head		
G18025	1/4"	25
G18037	3/8"	25
G18050	1/2" AGA	50
G18075	3/4" AGA	50
G18100	1"	25
G18125	1-1/4"	15
G18150	1-1/2"	10
G18200	2"	5



Flat/Tee Head		
G19025	1/4"	25
G19037	3/8"	25
G19050	1/2" AGA	50
G19075	3/4" AGA	50
G19100	1"	25
G19125	1-1/4"	15
G19150	1-1/2"	10
G19200	2"	5

Flare x Flare

• 30 PSI



PART NO.	SIZE
N01013	1/4"
N01014	3/8"
N01015	1/2"

Flare x Male Pipe

• 30 PSI



PART NO.	SIZE
N01016	1/4" x 1/8"
N01017	1/4" x 1/4"
N01018	3/8" x 1/4"

Flare x Female Pipe

• 30 PSI



PART NO.	SIZE
N01020	3/8" x 3/8"
N01021	1/2" x 1/2"
N01022	5/8" x 3/4"
N01023	5/8" x 1/2"

Compression x Male Pipe

• 30 PSI



PART NO.	SIZE
N01024	1/4" x 1/8"
N01025	1/4" x 1/4"
N01026	3/8" x 1/4"
N01040	5/16" x 1/4"

Female Pipe x Female Pipe

• 30 PSI



PART NO.	SIZE
N01010	1/8"
N01011	1/4"
N01012	3/8"

Female Pipe x Male Pipe

• 30 PSI



PART NO.	SIZE
N01027	1/8"
N01028	1/4"
N01029	3/8"

Compression x Compression

• 30 PSI



PART NO.	SIZE
N01007	1/4"
N01008	3/8"
N01009	1/2"

Drain Cock Internal Seat



PART NO.	SIZE
N01030	1/8"
N01031	1/4"

Drain Cock Tee Handle w/Bibb



• Hose x Male IPT

PART NO.	SIZE
N01032	1/4"

Drain Cock External Seat



PART NO.	SIZE
N01033	1/8"
N01034	1/4"
N01035	3/8"

Drain Cock



PART NO.	SIZE
N01001	1/8"
N01002	1/4"

Drain Cock Tank Valve



PART NO.	FLARE x MIP
N01005	3/8" x 1/2"
N01006	3/8" x 3/4"

Drain Cock Tank Valve



PART NO.	COMP x MIP
N01037	3/8" x 3/4"

Satin Brass Air Cock Female x Male Lever Handle Hex Shoulder



• Spring Bottoms

PART NO.	SIZE
A11011	1/8" x 1/8"
A11001	1/4" x 1/4"

Satin Brass Air Cock Male x Spigot Tee Handle Hex Shoulder



• Spring Bottoms

PART NO.	SIZE
A11002	1/4" x spigot

Satin Brass Air Cock Female x Male Tee Handle Hex Shoulder



• Spring Bottoms

PART NO.	SIZE
A11003	1/4" x 1/4"

Satin Brass Air Cock Female x Female Lever Handle Round Shoulder



• Spring Bottoms

PART NO.	SIZE
A11004	1/4" x 1/4"

Satin Brass Air Cock Female x Female Tee Handle Hex Shoulder



• Spring Bottoms

PART NO.	SIZE
A11005	1/4" x 1/4"

Satin Brass Air Cock Female x Female Tee Handle Round Shoulder



• Spring Bottoms

PART NO.	SIZE
A11016	1/8" x 1/8"
A11006	1/4" x 1/4"

Satin Brass Air Cock Female x Female Lever Handle Hex Shoulder



• Spring Bottoms

PART NO.	SIZE
A11017	1/8" x 1/8"
A11007	1/4" x 1/4"

Satin Brass Air Cock Female x Male Tee Handle Round Shoulder



• Spring Bottoms

PART NO.	SIZE
A11008	1/4" x 1/4"

Gas Ball Valves

- CSA- certified for use with natural, manufactured, mixed, liquefied petroleum gas/air mixtures up to 2 psig
- UL listed 757x (1/2" and 3/4")
- Forged brass body
- Chrome plated brass ball
- Temperatures up to 175°F
- Threaded ends comply with ANSI B2.1
- 3/8"x 3/4" one piece body
- 1"-2" two-piece body with plated steel handle



Lever Handle, Female x Female



PART NO.	SIZE	IN. CTN.	MSTR. CTN.
B64375	3/8" FIP	10	100
B64050	1/2" FIP	10	100
B64075	3/4" FIP	10	100
B64100	1" FIP	6	36
B64125	1 1/4" FIP	4	24
B64150	1 1/2" FIP	4	16
B64200	2" FIP	2	10

Tee Handle, Female x Female



PART NO.	SIZE	IN. CTN.	MSTR. CTN.
B65375	3/8" FIP	10	100
B65050	3/8" FIP	10	100
B65075	3/4" FIP	10	100
B65100	1" FIP	6	36

Square Head, Female x Female



PART NO.	SIZE	IN. CTN.	MSTR. CTN.
B66375	3/8" FIP	10	100
B66050	1/2" FIP	10	100
B66075	3/4" FIP	10	100
B66100	1" FIP	6	36

Two-Piece Gas Ball Valves

- CSA- certified for use with natural, manufactured, mixed liquefied petroleum and L.P. gas/air mixtures up to 2 psig
- Forged brass body
- Chrome plated brass ball
- Temperatures up to 125° F
- Two-piece body
- Made in Italy



PART NO.	SIZE	IN. CTN.	MSTR. CTN.
B64450	1/2"	10	50
B64475	3/4"	10	50

Texas Pattern Gas Ball Valve

- CSA certified
- Female IPS x hose end x 1/8" MIP
- Lever handle
- One piece forged body
- Made in Italy



PART NO.	SIZE	IN. CTN.	MSTR. CTN.
B69121	1/2" FIP x 1/8" MIP	10	100

Lever Handle Gas Ball Valves

- Forged brass body
- 3/4" Chrome plated forged brass ball
- Temperatures up to 175°F
- Threaded ends comply with ANSI B2.1
- CSA- certified for use with natural, manufactured, mixed, liquefied petroleum and LP gas/air mixtures up to 2 psig
- One piece body construction



Flare x Female



PART NO.	SIZE	IN. CTN.	MSTR. CTN.
B67375	3/8" flare x 1/2" FIP	10	100
B67050	1/2" flare x 1/2" FIP	10	100
B67937	15/16" flare x 1/2" FIP	10	100
B67975	15/16" flare x 3/4" FIP	10	100

Flare x Male



PART NO.	SIZE	IN. CTN.	MSTR. CTN.
B68001	1/2" flare x 1/2" MIP	10	100

Flare x Flare



PART NO.	SIZE	IN. CTN.	MSTR. CTN.
B68375	3/8" flare x 3/8" flare	10	100
B68050	1/2" flare x 1/2" flare	10	100
B68058	5/8" flare x 5/8" flare	10	100

Gas Heater Valves

- 9/16" - 24 Fine Thread Flare (for 3/8" tube)
- Forged brass body
- Chrome plated forged brass ball
- CSA certified for use with natural, manufactured, mixed, liquefied petroleum and LP gas/air mixtures up to 2 psig
- One piece body construction
- Temperatures up to 175°F
- Made in Italy



PART NO.	SIZE	IN. CTN.	MSTR. CTN.
B69050	9/16"-24 x 1/2" FIP	10	100

Brass Gas Ball Valves

- Two-piece forged brass body with chrome plated brass ball
- Double O-ring packing
- PTFE Seats
- 1/4 turn aluminum handle
- 1/2 PSI for indoor appliance connections per ANSI Z21.15/CGA 9.1
- Blowout-proof stem
- 5 PSI for indoor shutoff per CGA 91-002 & ASME B16.44
- CUS certified



Female x Female		
PART NO.	SIZE	CTN. QTY.
B67100	1/2" FIP x 1/2" FIP	1/160
B67101	3/4" FIP x 3/4" FIP	1/100

- Two-piece forged brass body with chrome plated brass ball
- Double O-ring packing
- PTFE Seats
- 1/4 turn aluminum handle
- 1/2 PSI for indoor appliance connections per ANSI Z21.15/CGA 9.1
- 5 PSI for indoor shutoff per CGA 91-002 & ASME B16.44
- CUS certified



Flare x Female		
PART NO.	SIZE	CTN. QTY.
B67102	3/8" FL x 1/2" FIP	1/160
B67103	1/2" FL x 1/2" FIP	1/160
Flare x Male		
PART NO.	SIZE	CTN. QTY.
B67104	1/2" FL x 1/2" MIP	1/160
Flare		
PART NO.	SIZE	CTN. QTY.
B67105	3/8" FL x 3/8" FL	1/160
B67106	1/2" FL x 1/2" FL	1/160

- Full-port design
- Forged brass body up to 4"
- Chrome plated brass ball
- Adjustable packing nut
- Non-sticking teflon seats
- 1/4 turn zinc plated steel handle
- 600psi, WOG (water, oil, gas)
- Working steam pressure: 150psi
- Blowout-proof stem
- Teflon packing for safety against leakage
- CUS / FM / NSF61 / UL certified



Threaded		
PART NO.	SIZE	CTN. QTY.
B67200	3/8"	20/100
B67201	1/2"	50/100
B67202	3/4"	30/60
B67203	1"	20/40
B67204	1-1/4"	12/24
B67205	1-1/2"	9/18
B67206	2"	6/12

- Full-port design
- Forged brass body up to 4"
- Chrome plated brass ball
- Adjustable packing nut
- Non-sticking teflon seats
- 1/4 turn zinc plated steel handle
- 600psi, WOG (water, oil, gas)
- Working steam pressure: 150psi
- Blowout-proof stem
- Teflon packing for safety against leakage
- FM / NSF61 / UL certified



Sweat		
PART NO.	SIZE	CTN. QTY.
B67207	3/8"	20/100
B67208	1/2"	50/100
B67209	3/4"	30/60
B67210	1"	20/40
B67211	1-1/4"	12/24
B67212	1-1/2"	9/18
B67213	2"	6/12

- Full-port with waste design
- Forged brass body
- Chrome plated brass ball
- Adjustable packing nut
- Non-sticking teflon seats
- 1/4 turn zinc plated steel handle
- 600psi, WOG (water, oil, gas)
- Working steam pressure: 150psi
- Blowout-proof stem
- Teflon packing for safety against leakage
- NSF61 certified



Brass Ball & Waste Valve Sweat		
PART NO.	SIZE	CTN. QTY.
B67214	1/2"	10/60
B67215	3/4"	10/60
B67216	1"	5/40



Brass Ball & Waste Valve Threaded		
PART NO.	SIZE	CTN. QTY.
B67217	1/2"	10/60
B67218	3/4"	10/60
B67219	1"	5/40

- Cast brass body
- Cast iron handle
- 125 PSI WOG to 100° F
- Maximum Temperature 180°F



Brass Stop Valve Threaded		
PART NO.	SIZE	CTN. QTY.
B67312	1/2"	6/48
B67313	3/4"	6/48



Brass Stop & Waste Valve Threaded		
PART NO.	SIZE	CTN. QTY.
B67315	3/4"	6/48



Brass Stop Valve Sweat		
PART NO.	SIZE	CTN. QTY.
B67316	1/2"	6/48
B67317	3/4"	6/48

- Forged brass body
- Copper or threads to hose
- Cast iron handle
- Non-sticking teflon seats
- 125 PSI WOG to 100°F
- Maximum Temperature 180°F
- Size range- 1/2" MIP (1/2" SWEAT) 3/4" MHT
- 3/4" MIP (1/2" SWEAT) 3/4" MHT



Brass Broiler Drain Valve - Male		
PART NO.	SIZE	CTN. QTY.
B67320	1/2" MIP x 3/4" MHT	6/48
B67321	3/4" MIP x 3/4" MHT	6/48

- Forged brass body
- Threads to hose
- Cast iron handle
- 125 PSI WOG to 100°F
- Maximum Temperature 180°F
- Size range- 1/2" FIP * 3/4" MHT



Brass Broiler Drain Valve - Female		
PART NO.	SIZE	CTN. QTY.
B67322	1/2" FIP x 3/4" MHT	6/48
B67323	3/4" FIP x 3/4" MHT	6/48

Full Port Ball Valves

600# WOG/ 125# WSP

- Forged brass
- Chrome plated ball
- Teflon seats
- Blowout-proof stem
- Vinyl grip and vibration-proof locknut
- Temperature range: -20°F to 350°F (call for pressure rating when temperature is above 210°F)
- CSA- certified (1/2"-2") for use with natural, manufactured, mixed, liquefied petroleum and LP gas/air mixtures up to 2 psi
- Complies with Federal Specification WW-V-35B, Type II, Style 3
- Threaded ends comply with ANSI B2.1
- Solder ends comply with ANSI B16.18



Threaded Ends



PART NO.	SIZE	PORT	IN. CTN.	MSTR. CTN.
B60025	1/4"	0.315	20	200
B60375	3/8"	0.394	10	100
B60050	1/2"	0.590	10	100
B60075	3/4"	0.787	10	100
B60100	1"	0.984	10	50
B60125	1 1/4"	1.260	10	20
B60150	1 1/2"	1.575	4	20
B60200	2"	1.968	4	20
B60250	2 1/2"	2.283	2	6
B60300	3"	2.677	2	4
B60400	4"	3.543	1	2

Solder Ends



PART NO.	SIZE	PORT	IN. CTN.	MSTR. CTN.
B61050	1/2"	0.590	10	100
B61075	3/4"	0.787	5	60
B61100	1"	0.984	6	36
B61125	1 1/4"	1.260	4	24
B61150	1 1/2"	1.575	4	16
B61200	2"	1.968	2	10

Threaded Ends With 1/8" Waste



PART NO.	SIZE	PORT	IN. CTN.	MSTR. CTN.
B60650	1/2"		10	100
B60675	3/4"		10	100
B60610	1"		10	100

Solder Ends With 1/8" Waste



PART NO.	SIZE	PORT	IN. CTN.	MSTR. CTN.
B60750	1/2"		10	100
B60775	3/4"		10	100
B60710	1"		10	100

PVC Ball Valves Solvent End

- One piece body construction
- Standard port
- EPDM seats and o-rings
- Working pressure 150 psi at 73°F
- Quarter turn operation
- Not for compressed air
- Ideal for swimming pools, irrigation and water supply uses
- Solvent ends comply with ASTM D 2466
- Threaded ends comply with ANSI B2.1
- For cold water lines
- Large flow opening



PART NO.	SIZE	CTN. QTY.
B90050	1/2"	100
B90075	3/4"	100
B90100	1"	100
B90125	1 1/4"	100
B90150	1 1/2"	48
B90200	2"	24
B90250	2 1/2"	12
B90300	3"	12
B90400	4"	6

PVC Ball Valves Threaded Ends

- One piece body construction
- Standard port
- EPDM seats and o-rings
- Working pressure 150 psi at 73°F
- Quarter turn operation
- Not for compressed air
- Ideal for swimming pools, irrigation and water supply uses
- Solvent ends comply with ASTM D 2466
- Threaded ends comply with ANSI B2.1
- For cold water lines
- Large flow opening



PART NO.	SIZE	CTN. QTY.
B91050	1/2"	100
B91075	3/4"	100
B91100	1"	100
B91125	1 1/4"	100
B91150	1 1/2"	48
B91200	2"	24
B91250	2 1/2"	12
B91300	3"	12
B91400	4"	6

CPVC Ball Valves

- NSF approved!
- Standard port
- For use on CPVC tubing size (OD)
- Teflon seats
- EPDM o-rings
- One piece body construction
- Large flow opening
- For hot or cold water lines up to 100 psi at temperature up to 180°F
- Solvent ends comply with ASTM D2846
- Quarter turn operation



PART NO.	SIZE	CTN. QTY.
B92050	1/2" (5/8" OD)	100
B92075	3/4" (7/8" OD)	100

Radiator Coin Key Air Valve And Key

• CARTON QUANTITY ONLY



PART NO.	DESCRIPTION	CTN. QTY.
R20001	Vent valve with key	100
R20002	Key only	100
R20003	Valve only	100

Single Union PVC Swimming Pool Valves



- Teflon seats
- 150 psi working pressure
- EPDM o-rings seal on union end
- Suitable for swimming pools, spas and plumbing
- Full port
- Solvent ends

PART NO.	SIZE	CTN. QTY.
B95150	1-1/2"	10
B95200	2"	10

Dual Check Backflow Preventer



- Female by female
- Forged brass body
- 150 psi
- Acetyl-resin check modules
- Stainless steel spring
- 180° F maximum temperature

PART NO.	SIZE	CTN. QTY.
B59001	3/4"	10
B59002	1"	10

Inline PVC Check Valves



- Stainless steel spring
- EPDM seats
- Maintenance-free operation
- .5 psi required to open unit
- 200 psi static pressure rating at 77°F
- Use anywhere to stop backflow and siphoning
 - Swimming Pools - Hot Tubs - Spas
 - Solar Installations

Solvent Ends

PART NO.	SIZE	CTN. QTY.
C30050	1/2"	12
C30075	3/4"	12
C30100	1"	12
C30125	1-1/4"	12
C30150	1-1/2"	12
C30200	2"	6

Threaded Ends



PART NO.	SIZE	CTN. QTY.
C31050	1/2"	12
C31075	3/4"	12
C31100	1"	12
C31125	1-1/4"	12
C31150	1-1/2"	12
C31200	2"	6

Forged Brass Hose Bibb



- Hard chrome ball
- Quarter-turn operation
- Teflon seats
- T-handle

PART NO.	SIZE	CTN. QTY.
B60950	1/2"	10
B60975	3/4"	10

Hose Faucet Anchor



- Long lasting solution to loosen exterior faucets
- Works with any wall material (brick, concrete, vinyl siding or stucco)
- For repair or new home applications
- Fits all exterior or faucet water lines
- Corrosion free



PART NO.	DESCRIPTION	CTN. QTY.
B59000	Hose faucet anchor	1

Cast Brass Hose Bibb



PART NO.	MIP x MALE HOSE	CTN. QTY.
B59050	1/2" x 3/4"	12
B59075	3/4" x 3/4"	12
B59100	1" x 1"	6

Hose Bibb Reducer



- Reduces 1" hose bibb to standard 3/4" garden hose

PART NO.	FHT x MHT	CTN. QTY.
G20058	1" x 3/4"	10

Hose Bibb Vacuum Breaker



- 3/4" hose thread
- Vandal-proof breakoff screw
- Brass
- ASSE 1011

PART NO.	DESCRIPTION	CTN. QTY.
G04003	Vacuum breaker	50

Economy Hose Bibb Vacuum Breaker



- Brass
- 3/4" hose thread

PART NO.	DESCRIPTION	CTN. QTY.
G04004	Economy Vacuum Breaker	50

Micro Size

• CARTON QUANTITY ONLY
• 5/16" band

Part Stainless



PART NO.	TRADE SIZE	SIZE	CTN.QTY.
G08004	4	1/4" - 5/8"	10/1000
G08006	6	5/16" - 7/8"	10/1000
G08008	8	3/8" - 1"	10/500
G08012	12	1/2" - 1 1/4"	10/500
G08016	16	1/2" - 1 1/2"	10/500
G08020	20	3/4" - 1 3/4"	10/500
G08024	24	1" - 2"	10/500

All Stainless



PART NO.	TRADE SIZE	SIZE	CTN.QTY.
G09004	4	1/4" - 5/8"	10/1000
G09006	6	5/16" - 7/8"	10/1000
G09008	8	1/2" - 1"	10/500
G09012	12	1/2" - 1 1/4"	10/500
G09016	16	1/2" - 1 1/2"	10/500
G09020	20	3/4" - 1 3/4"	10/500
G09024	24	1" - 2"	10/500

Full Size

• CARTON QUANTITY ONLY
• 1/2" band

Part Stainless



PART NO.	TRADE SIZE	SIZE	CTN.QTY.
G10006	6	3/8" - 7/8"	10/200
G10008	8	7/16" - 1"	10/200
G10010	10	1/2" - 1 1/16"	10/500
G10012	12	1/2" - 1 1/4"	10/500
G10016	16	3/4" - 1 1/2"	10/500
G10020	20	3/4" - 1 3/4"	10/500
G10024	24	1" - 2"	10/500
G10032	32	1 1/2" - 2 1/2"	10/500
G10036	36	7/8" - 2 3/4"	10/500
G10040	40	1 1/8" - 3"	10/200
G10052	52	1 7/8" - 3 3/4"	10/100
G10072	72	3 1/8" - 5"	10/100
G10080	80	3 5/8" - 5 1/2"	10/100
G10104	104	5" - 7"	10/100

All Stainless



PART NO.	TRADE SIZE	SIZE	CTN.QTY.
G11006	6	3/8" - 7/8"	10/200
G11008	8	7/16" - 1"	10/200
G11010	10	1/2" - 1 1/16"	10/500
G11012	12	1/2" - 1 1/4"	10/500
G11016	16	11/16" - 1 1/2"	10/500
G11020	20	3/4" - 1 3/4"	10/500
G11024	24	1" - 2"	10/500
G11028	28	1 5/16" - 2 1/4"	10/500
G11032	32	1 9/16" - 2 1/2"	10/500
G11036	36	7/8" - 2 3/4"	10/500
G11040	40	1 1/8" - 3"	10/200
G11044	44	2 1/4" - 3 1/4"	10/200
G11048	48	1 5/8" - 3 1/2"	10/200
G11052	52	1 7/8" - 3 3/4"	10/200
G11056	56	2 1/8" - 4"	10/100
G11064	64	2 1/2" - 4 1/2"	10/100
G11072	72	3" - 5"	10/100
G11080	80	3 1/2" - 5 1/2"	10/100
G11088	88	4" - 6"	10/100
G11096	96	4 3/4" - 6 1/2"	10/100
G11104	104	5" - 7"	10/100

"68" Series Stainless Gear Clamps

- 9/16" band
- All stainless, 300 grade construction
- Ideal for well drilling and applications requiring marine grade stainless clamps
- CARTON QUANTITY ONLY



PART NO.	TRADE SIZE	SIZE	CTN.QTY.
G14006	6	3/8" - 7/8"	10/200
G14008	8	7/16" - 1"	10/200
G14010	10	1/2" - 1 1/16"	10/500
G14012	12	1/2" - 1 1/4"	10/500
G14016	16	11/16" - 1 1/2"	10/500
G14020	20	3/4" - 1 3/4"	10/500
G14024	24	1" - 2"	10/500
G14028	28	1 1/4" - 2 1/4"	10/500
G14032	32	1 1/2" - 2 1/2"	10/500
G14036	36	1 3/4" - 2 3/4"	10/200
G14040	40	1 1/8" - 3"	10/200
G14044	44	2 1/4" - 3 1/4"	10/200
G14048	48	1 5/8" - 3 1/2"	10/200
G14052	52	1 7/8" - 3 3/4"	10/100
G14056	56	2 1/8" - 4"	10/100
G14064	64	2 1/2" - 4 1/2"	10/100
G14072	72	3" - 5"	10/100
G14080	80	3 1/2" - 5 1/2"	10/100
G14088	88	4" - 6"	10/100
G14096	96	4 1/2" - 6 1/2"	10/100
G14104	104	5" - 7"	10/100

Replacement Clamp For Flexible Couplings



• CARTON QUANTITY ONLY

PART NO.	DESCRIPTION	CTN. QTY.
G15002	2" Replacement clamp	10
G15003	3" Replacement clamp	10
G15004	4" Replacement clamp	10
G15006	6" Replacement clamp	50
G15008	8" Replacement clamp	50

Asbestos- Free Full Face Gasket



- Meets ASTM F152, F36A and F146
- Manufactured of Garlock 4401
- 1/16" thick
- Temperature rating of 750°F

PART NO.	SIZE	LBS.
G54075	3/4"	150
G54001	1"	150
G54013	1 1/4"	150
G54015	1 1/2"	150
G54002	2"	150
G54025	2 1/2"	150
G54003	3"	150
G54035	3 1/2"	150
G54004	4"	150
G54005	5"	150
G54006	6"	150
G54008	8"	150
G54010	10"	150
G54012	12"	150

Red Rubber Full Face Gasket



- Meets ASTM D1330
- 1/16" thick
- Temperature rating of 350° F

PART NO.	SIZE	LBS.
G51050	1/2"	150
G51075	3/4"	150
G51001	1"	150
G51013	1 1/4"	150
G51015	1 1/2"	150
G51002	2"	150
G51025	2 1/2"	150
G51003	3"	150
G51035	3 1/2"	150
G51004	4"	150
G51005	5"	150
G51006	6"	150
G51008	8"	150
G51010	10"	150
G51012	12"	150

Asbestos- Free Ring Gasket



- Meets ASTM F152, F36A and F146
- Manufactured of Garlock 4401
- 1/16" thick
- Temperature rating of 750°F

PART NO.	SIZE	LBS.
G53050	1/2"	150
G53075	3/4"	150
G53001	1"	150
G53013	1 1/4"	150
G53015	1 1/2"	150
G53002	2"	150
G53025	2 1/2"	150
G53003	3"	150
G53035	3 1/2"	150
G53004	4"	150
G53005	5"	150
G53006	6"	150
G53008	8"	150
G53010	10"	150
G53012	12"	150

Red Rubber Ring Gasket



- Meets ASTM D1330
- 1/16" thick
- Temperature rating of 350° F

PART NO.	SIZE	LBS.
G52075	3/4"	150
G52001	1"	150
G52013	1 1/4"	150
G52015	1 1/2"	150
G52002	2"	150
G52025	2 1/2"	150
G52003	3"	150
G52035	3 1/2"	150
G52004	4"	150
G52005	5"	150
G52006	6"	150
G52008	8"	150
G52010	10"	150
G52012	12"	150

Asbestos- Free Full Face Gasket



- Meets ASTM F152, F36A and F146
- Gaskets are 1/16" thick
- ASTM A307 hex bolts and heavy hex nuts
- Constructed of Garlock 4401

PART NO.	PIPE SIZE	BOLT SIZE	BOLTS/ KIT
G54115	1-1/2"	1/2" x 2-1/4"	4
G54102	2"	5/8" x 2-3/4"	4
G54125	2-1/2"	5/8" x 3"	4
G54103	3"	5/8" x 3"	4
G54104	4"	5/8" x 3"	8
G54105	5"	3/4" x 3-1/4"	8
G54106	6"	3/4" x 3-1/4"	8
G54108	8"	3/4" x 3-1/2"	8
G54110	10"	7/8" x 3-3/4"	12
G54112	12"	7/8" x 4"	12

Red Rubber Ring Gasket Kits



- Meets ASTM D1330
- Gaskets are 1/16" thick
- ASTM A307 hex bolts and heavy hex nuts

PART NO.	PIPE SIZE	BOLT SIZE	BOLTS/ KIT
G52115	1-1/2"	1/2" x 2-1/4"	4
G52102	2"	5/8" x 2-3/4"	4
G52125	2-1/2"	5/8" x 3"	4
G52103	3"	5/8" x 3"	4
G52104	4"	5/8" x 3"	8
G52105	5"	3/4" x 3-1/4"	8
G52106	6"	3/4" x 3-1/4"	8
G52108	8"	3/4" x 3-1/2"	8
G52110	10"	7/8" x 3-3/4"	12

Asbestos- Free Ring Gasket Kits



- Meets ASTM F152, F36A and F146
- Gaskets are 1/16" thick
- ASTM A307 hex bolts and heavy hex nuts
- Constructed of Garlock 4401

PART NO.	PIPE SIZE	BOLT SIZE	BOLTS/ KIT
G53101	1"	1/2" x 2"	4
G53113	1-1/4"	1/2" x 2-1/4"	4
G53115	1-1/2"	1/2" x 2-1/4"	4
G53102	2"	5/8" x 2-3/4"	4
G53125	2-1/2"	5/8" x 3"	4
G53103	3"	5/8" x 3"	4
G53104	4"	5/8" x 3"	8
G53105	5"	3/4" x 3-1/4"	8
G53106	6"	3/4" x 3-1/4"	8
G53108	8"	3/4" x 3-1/2"	8
G53110	10"	7/8" x 3-3/4"	12

Insulation Kits With Poly Sleeves



- Use with flange connection kits
- To form dielectric connection; fiber washers

PART NO.	DESCRIPTION	CTN. QTY.
G55150	1-1/2" Insulation kit	1
G55200	2" Insulation kit	1
G55250	2-1/2" Insulation kit	1
G55300	3" Insulation kit	1
G55350	4" Insulation kit	1
G55400	5" Insulation kit	1
G55450	6" Insulation kit	1
G55500	8" Insulation kit	1
G55550	10" Insulation kit	1
G55600	12" Insulation kit	1

Red Rubber Full Face Gasket Kits



- Meets ASTM D1330
- Gaskets are 1/16" thick
- ASTM A307 hex bolts and heavy hex nuts

PART NO.	PIPE SIZE	BOLT SIZE	BOLTS/ KIT
G51102	2"	5/8" x 2-3/4"	4
G51125	2-1/2"	5/8" x 3"	4
G51103	3"	5/8" x 3"	4
G51135	3-1/2"	5/8" x 3"	8
G51104	4"	5/8" x 3"	8
G51105	5"	3/4" x 3-1/4"	8
G51106	6"	3/4" x 3-1/4"	8
G51108	8"	3/4" x 3-1/2"	8
G51110	10"	7/8" x 3-3/4"	12
G51112	12"	7/8" x 4"	12

Asbestos-Free Ring Gasket Kits Supplied w/Insulation Kits



PART NO.	PIPE SIZE	BOLT SIZE	BOLTS/ KIT
G53203	3"	5/8" x 3"	4
G53204	4"	5/8" x 3"	8
G53206	6"	3/4" x 3 1/4"	8
G53215	1 1/2"	1/2" x 2 1/4"	4
G53225	2 1/2"	5/8" x 3"	4

Asbestos-Free Full Face Gasket Kits Supplied w/Insulation Kits



PART NO.	PIPE SIZE	BOLT SIZE	BOLTS/ KIT
G54215	1-1/2"	1/2" x 2-1/4"	4
G54202	2"	5/8" x 2-3/4"	4
G54225	2-1/2"	5/8" x 3"	4
G54203	3"	5/8" x 3"	4
G54204	4"	5/8" x 3"	8
G54205	5"	3/4" x 3-1/4"	8
G54206	6"	3/4" x 3-1/4"	8
G54208	8"	3/4" x 3-1/2"	8
G54210	10"	7/8" x 3-3/4"	12
G54212	12"	7/8" x 4"	12

Red Rubber Sheet Packing/Gasket Material

- Priced per roll (approximately 100 pounds)
- FULL ROLLS ONLY



PART NO.	DESCRIPTION	CTN. QTY.
G55016	1/16" x 36" x 60'	1 roll
G55018	1/8" x 36" x 30'	1 roll
G55014	1/4" x 36" x 15'	1 roll

Red Rubber Sheet Packing/Gasket Material



- Single 3' x 5' sheet

PART NO.	MATERIAL	THICKNESS	CTN. QTY.
G55116	Red Rubber (1 sheet)	1/16"	1
G55118	Red Rubber (1 sheet)	1/8"	1

Gasket And Washer Materials



- Make your own gaskets and washers
- 6" x 6" square in hanging display bag

PART NO.	MATERIAL	THICKNESS	CTN. QTY.
G55001	Red Rubber (1 sheet)	1/16"	12
G55002	Black Fiber (1 sheet)	1/32"	12
G55003	Cork/Rubber (1 sheet)	1/16"	12
G55004	Combo (1 sheet of each)	—	1

Circulator Flange Gasket Pair



- SOLD IN PAIRS ONLY

PART NO.	DESCRIPTION	CTN. QTY.
G55005	Circulator Flange Gasket	1

Water Hammer Arresters

- Maximum working temp: 250°F
- Maximum working pressure: 300psi
- Burst pressure: 2900psi
- Polly Bagged



FIXTURE	TYPE OF SUPPLY CONTROL	PUBLIC			PRIVATE		
		TOTAL	C.W.	H.W.	TOTAL	C.W.	H.W.
Water Closet	Flush Valve	10	10	--	6	6	--
Water Closet	Flush Tank	5	5	--	3	3	--
Pedestal Urinal	Flush Valve	10	10	--	--	--	--
Stall or Wall Unit	Flush Valve	5	5	--	--	--	--
Stall or Wall Unit	Flush Tank	3	3	--	--	--	1
Lavatory	Faucet	2	1-1/2	1-1/2	1	1	1-1/2
Bathtub	Faucet	4	2	3	2	1-1/2	1-1/2
Shower Head	Mixing Valve	4	2	3	2	1	2
Bathroom Group	Flush Valve Closet	--	--	--	8	8	3
Bathroom Group	Flush Tank Closet	--	--	--	6	6	3
Separate Shower	Mixing Valve	--	--	--	2	1	2
Service Sink	Faucet	3	3	3	--	--	--
Laundry Tubs (3)	Faucet	--	--	--	3	3	3
Combination Fixture	Faucet	--	--	--	3	3	3

Now apply the total fixture units to Table B to obtain your PDI size value.

PDI SIZE ARRESTER:	AA	A	B	C	D	E	F
FIXTURE UNITS:	1-5	1-11	12-32	33-60	61-113	114-154	155-330
THREAD SIZE:	1/2	1/2	3/4	3/4	1	1	1
CATALOG NUMBER:	ALL A95 SERIES						

MIP AA



PART NO.	SIZE	CTN. QTY.
A95001	1/2"	25

MSWT AA



PART NO.	SIZE	CTN. QTY.
A95002	1/2"	25

MSWT AA



PART NO.	SIZE	CTN. QTY.
A95003	3/4"	25

CPVC AA



PART NO.	SIZE	CTN. QTY.
A95004	1/2"	25

OD COMP AA



PART NO.	SIZE	CTN. QTY.
A95005	5/8"	25

PEX TEE AA



PART NO.	SIZE	CTN. QTY.
A95006	3/8"	25
A95007	1/2"	25

OD TEE AA



PART NO.	SIZE	CTN. QTY.
A95008	1/4"	25
A95009	3/8"	25
A95010	5/8"	25

Female Comp. x OD Comp.



PART NO.	SIZE	CTN. QTY.
A95014	3/8" x 3/8"	25

MHT x FHS AA



PART NO.	SIZE	CTN. QTY.
A95011	3/4"	25

3' Chrome Plated Brass Cover Tubes	3	Garden Hose Fittings.....	23, 24
45° Elbow	7, 18, 21	Gas Ball Valves	34
45° Street Elbow	7, 18	Gas Heater Valves.....	34
90° Elbow	7, 18, 21	Gasket	41
90° Male Elbow.....	7	Asbestos- Free Full Face Gasket	41
90° Street Elbow	7, 18, 21	Asbestos- Free Ring Gasket.....	41
B		Red Rubber Full Face Gasket	41
Backflow Preventer	37	Red Rubber Ring Gasket	41
Ball Valves.....	35	Gasket Kits.....	42
Bell Reducer	7	Gas Range Fittings	6
Brass Compression Insert	1	Gas Shut-Off Valve.....	32
Brass Needle Valve	31	Gear Clamps	
Brass Saddle Clamp	31	"68" Series Stainless.....	40
Bronze Locknuts	18	Full Size.....	39
Bushing.....	21	Micro Size	39
C		H	
Cap.....	4, 7, 19, 22	HEX Brushing	20
Check Valves	37	HEX Bushing.....	8
Chrome Elbow	3	HEX Head Plug	7
Chrome Plated		HEX Nipple	8
Compression Connector	3	Hose Barb Fittings.....	25
Compression Elbow.....	3	Hose Bibb.....	38
Compression x Sweat Adapter	3	Hose Bibb Reducer.....	38
Chrome Plated Nipples & Pipe Lengths.....	21	Hose Faucet Anchor	38
Chrome Union	3	I	
Close Nipple	8	Icemaker Or Humidifier Kit	31
Compression Branch Tee.....	1	L	
Compression Cap	1	Lock Nut.....	8
Compression Connector	2	Long Flare Nut.....	4
Compression Elbow	2	Long Nipple.....	8
Compression Nut.....	3	N	
Chrome Plated Compression Nut	3	Nylon Garden Hose Fittings.....	26
Compression Nuts	1	Nylon Hose Barb Fittings.....	26
Compression Sleeve	1	Nylon Insert Adapters	27
Compression Tee	1	O	
Compression Union	1	Oetiker PEX Stainless Steel Clamp.....	10
Compression x Sweat Adapter	2	P	
Corded Square Head Plug	20	PEX 90° Ell	9
Countersunk Plug	8, 20	PEX 90° Ell Swivel Plastic Nut.....	9
Coupling.....	7, 21	Pex Adapter	10
Coupling/ Reducer.....	19	PEX Adapter	9
Cross.....	20	Pex Coupling	10
D		PEX Couplings.....	9
Delrin Compression Sleeve	1	PEX Crimp Ring	10
Drain Cock	33	PEX Drop Ear 90° Ell	10
Drain Cock Tank Valve	33	Pex Elbow	10
E		PEX Equal Tee.....	9
Extension Piece.....	19	PEX Plug	10
F		PEX Sweat Adapter	9
Face Bushing	8	PEX Swivel Plastic Nut	9
Female Flare Swivel	4	Pex Tee	10
Flare Elbow	5	PEX Tee.....	9
Flare Tees.....	4	Pilot Line Breakaway Nut.....	2
Flare Union	4	Plastic Push On Fittings	14
Flare x FIP Coupling.....	5	Plug.....	4, 22
Flare x MIP Branch Tee	4	PlumBite Push On Fittings	11
Flare x MIP Half Union	5	Poly Insert Fittings	28
Full Port Ball Valves	35	R	
G		Radiator Coin Key Air Valve And Key	36
Galvanized Insert Fittings.....	30	Red Brass Insert Fittings.....	29

Red Brass Pipe Nipples.....	16
Red Rubber Sheet Packing/Gasket Material.....	43
Reducer.....	21
Replacement Clamp For Flexible Couplings.....	40
S	
Satin Brass Air Cock.....	33
Short Flare Nut.....	4
Solid Square Head Plug.....	20
Space Heater Fittings.....	6
Square Head Plug.....	7
Swimming Pool Valves.....	37
T	
Tee.....	7, 19, 21
Texas Pattern Gas Ball Valve.....	34
Twist To Lock Plastic Fittings.....	12
U	
Union.....	18, 22
W	
Water Hammer Arresters.....	44

PART NO.	PG #
A11001	33
A11002	33
A11003	33
A11004	33
A11005	33
A11006	33
A11007	33
A11008	33
A11011	33
A11016	33
A11017	33
A95001	44
A95002	44
A95003	44
A95004	44
A95005	44
A95006	44
A95007	44
A95008	44
A95009	44
A95010	44
A95011	44
A95014	44
B50001	21
B50002	21
B50003	21
B50004	21
B50011	21
B50012	21
B50013	21
B50014	21
B50031	21
B50032	21
B50033	21
B50034	21
B50041	21
B50042	21
B50043	21
B50044	21
B50051	21
B50052	21
B50072	21
B50073	21
B50074	21
B50075	21
B50081	22
B50082	22
B50083	22
B50084	22
B50091	22
B50092	22
B50093	21
B50094	21
B50095	22
B50096	22
B50097	22
B50098	21
B50099	22
B50100	22
B50101	22
B50103	21
B59000	38
B59001	37
B59002	37
B59050	38
B59075	38
B59100	38

PART NO.	PG #
B60025	36
B60050	36
B60075	36
B60100	36
B60125	36
B60150	36
B60200	36
B60250	36
B60300	36
B60375	36
B60400	36
B60610	36
B60650	36
B60675	36
B60710	36
B60750	36
B60775	36
B60950	38
B60975	38
B61050	36
B61075	36
B61100	36
B61125	36
B61150	36
B61200	36
B64050	34
B64075	34
B64100	34
B64125	34
B64150	34
B64200	34
B64375	34
B64450	34
B64475	34
B65050	34
B65075	34
B65100	34
B65375	34
B66050	34
B66075	34
B66100	34
B66375	34
B67050	34
B67100	35
B67101	35
B67102	35
B67103	35
B67104	35
B67105	35
B67106	35
B67200	35
B67201	35
B67202	35
B67203	35
B67204	35
B67205	35
B67206	35
B67207	35
B67208	35
B67209	35
B67210	35
B67211	35
B67212	35
B67213	35
B67214	35
B67215	35
B67216	35

PART NO.	PG #
B67217	35
B67218	35
B67219	35
B67312	35
B67313	35
B67315	35
B67316	35
B67317	35
B67320	35
B67321	35
B67322	35
B67323	35
B67375	34
B67937	34
B67975	34
B68001	34
B68050	34
B68058	34
B68375	34
B69050	34
B69121	34
B74001	18
B74002	18
B74003	18
B74004	18
B74005	18
B74006	18
B74007	18
B74008	18
B74009	18
B74010	18
B74011	18
B74012	18
B74021	18
B74022	18
B74023	18
B74024	18
B74025	18
B74026	18
B74027	18
B74028	18
B74029	18
B74030	18
B74031	18
B74032	18
B74041	18
B74042	18
B74043	18
B74044	18
B74045	18
B74046	18
B74047	18
B74048	18
B74049	18
B74050	18
B74051	18
B74052	18
B74061	18
B74062	18
B74063	18
B74064	18
B74065	18
B74066	18
B74067	18
B74068	18
B74069	18
B74081	19

PART NO.	PG #
B74082	19
B74083	19
B74084	19
B74085	19
B74086	19
B74087	19
B74088	19
B74089	19
B74090	19
B74091	19
B74092	19
B74101	20
B74102	20
B74103	20
B74104	20
B74105	20
B74106	20
B74107	20
B74108	20
B74109	20
B74121	19
B74122	19
B74123	19
B74124	19
B74125	19
B74126	19
B74127	19
B74128	19
B74129	19
B74130	19
B74131	19
B74132	19
B74140	19
B74141	19
B74142	19
B74143	19
B74144	19
B74145	19
B74146	19
B74147	19
B74148	19
B74149	19
B74150	19
B74151	19
B74152	19
B74153	19
B74154	19
B74155	19
B74156	19
B74157	19
B74158	19
B74159	19
B74160	19
B74161	19
B74162	19
B74163	19
B74164	19
B74181	19
B74182	19
B74183	19
B74184	19
B74185	19
B74186	19
B74187	19
B74188	19
B74189	19
B74190	19

PART NO.	PG #
B74191	19
B74192	19
B74200	20
B74201	20
B74202	20
B74203	20
B74204	20
B74205	20
B74206	20
B74207	20
B74208	20
B74209	20
B74210	20
B74211	20
B74212	20
B74213	20
B74214	20
B74215	20
B74216	20
B74217	20
B74218	20
B74219	20
B74220	20
B74221	20
B74222	20
B74223	20
B74224	20
B74225	20
B74226	20
B74227	20
B74228	20
B74229	20
B74230	20
B74231	20
B74232	20
B74233	20
B74234	20
B74235	20
B74261	18
B74262	18
B74263	18
B74264	18
B74265	18
B74266	18
B74267	18
B74268	18
B74269	18
B74270	18
B74271	18
B74272	18
B74284	20
B74285	20
B74286	20
B74287	20
B74288	20
B74289	20
B74290	20
B74291	20

PART NO.	PG #
B74292	20
B74301	20
B74302	20
B74303	20
B74304	20
B74305	20
B74306	20
B74307	20
B74308	20
B74309	20
B74310	20
B74311	20
B74312	20
B74321	20
B74322	20
B74323	20
B74324	20
B74325	20
B74326	20
B74327	20
B74328	20
B74329	20
B74330	20
B74331	20
B74332	20
B74340	18
B74341	18
B74342	18
B74343	18
B74344	18
B74345	18
B74346	18
B74347	18
B74348	18
B74354	19
B74355	19
B74356	19
B74357	19
B74358	19
B74359	19
B74360	19
B74361	19
B74362	19
B74363	19
B74364	19
B74365	19
B74366	19
B74367	19
B74368	19
B74369	19
B74370	19
B74380	18
B74381	18
B74382	18
B74383	18
B74384	18
B74385	18
B74386	18

PART NO.	PG #
B74387	18
B74388	18
B74389	18
B74390	18
B74391	18
B74392	19
B74393	19
B74394	19
B74397	19
B74400	19
B90050	36
B90075	36
B90100	36
B90125	36
B90150	36
B90200	36
B90250	36
B90300	36
B90400	36
B91050	36
B91075	36
B91100	36
B91125	36
B91150	36
B91200	36
B91250	36
B91300	36
B91400	36
B92050	36
B92075	36
B95150	37
B95200	37
C30050	37
C30075	37
C30100	37
C30125	37
C30150	37
C30200	37
C31050	37
C31075	37
C31100	37
C31125	37
C31150	37
C31200	37
C74001	1
C74002	1
C74003	1
C74004	1
C74005	1
C74006	1
C74007	1
C74008	1
C74009	1
C74010	1
C74011	1
C74012	1
C74013	1
C74014	1

PART NO.	PG #
C74015	1
C74016	1
C74017	1
C74018	1
C74019	1
C74020	1
C74021	1
C74022	1
C74023	1
C74024	1
C74025	1
C74026	1
C74027	1
C74028	1
C74029	1
C74030	1
C74031	1
C74032	1
C74033	1
C74034	1
C74035	1
C74036	1
C74037	1
C74038	1
C74039	1
C74040	2
C74041	2
C74042	2
C74043	2
C74044	2
C74045	2
C74046	2
C74047	2
C74048	2
C74049	2
C74050	2
C74051	2
C74052	2
C74053	2
C74054	2
C74055	2
C74056	1
C74057	1
C74058	2
C74059	2
C74060	2
C74061	2
C74062	2
C74063	2
C74064	2
C74065	2
C74066	2
C74067	2
C74068	2
C74069	2
C74070	2
C74071	2
C74072	2

PART NO.	PG #
C74073	2
C74074	2
C74075	2
C74076	2
C74077	2
C74078	2
C74079	2
C74080	2
C74081	2
C74082	2
C74083	2
C74084	2
C74085	2
C74086	2
C74087	2
C74088	2
C74089	2
C74090	2
C74091	1
C74092	1
C74093	2
C74094	3
C74095	3
C74096	1
C74097	1
C74098	1
C74099	1
C74100	1
C74100T	1
C74101	1
C74101T	1
C74102	1
C74103	1
C74104	1
C74106	1
C74107	1
C74108	1
C74109	2
C74110	2
C74111	2
C74112	2
C74113	2
C74114	2
C74115	2
C74116	2
C74117	2
C74118	2
C74119	2
C74120	2
C74121	2
C74122	2
C74123	2
C74124	2
C74125	2
C74126	2
C74127	2
C74128	2
C74129	2

PART NO.	PG #
C74130	2
C74131	2
C74132	2
C74133	2
C74134	2
C74135	2
C74136	2
C74137	2
C74138	2
C74139	2
C74140	2
C74141	2
C74142	2
C74143	2
C74144	2
C74145	1
C74146	2
C74147	1
C74148	2
C74149	2
C74150	2
C74151	1
C74152	1
C74154	1
C74155	1
C74156	2
C74157	2
C74158	2
C76001	9
C76002	9
C76003	9
C76004	9
C76005	9
C76008	9
C76009	9
C76010	9
C76013	9
C76014	9
C76015	9
C76016	9
C76017	9
C76018	9
C76019	9
C76020	9
C76021	9
C76022	9
C76023	9
C76024	9
C76025	9
C76027	9
C76028	9
C76029	9
C76030	9
C76034	9
C76035	9
C76036	9
C76037	9
C76038	9

PART NO.	PG #
C76041	9
C76042	9
C76043	9
C76044	9
C76047	9
C76048	9
C76049	9
C76050	9
C76051	9
C76055	9
C76056	9
C76057	9
C76060	9
C76061	9
C76065	10
C76066	10
C76067	10
C76070	10
C76071	10
C76072	10
C76073	10
C76074	10
C76075	10
C76076	10
C76077	10
C76079	10
C76080	10
C76081	10
C76500	11
C76501	11
C76502	11
C76503	11
C76504	11
C76505	11
C76506	11
C76507	11
C76508	11
C76509	11
C76510	11
C76511	11
C76512	11
C76513	11
C76514	11
C76515	11
C76516	11
C76520	11
C76521	11
C76522	11
C76530	11
C76531	11
C76532	11
C76550	11
C76551	11
C76553	11
C76554	11
C76555	11
C76556	11
C76557	11

PART NO.	PG #
C76558	11
C76561	11
C76562	11
C76563	11
C76700	10
C76701	10
C76702	10
C76703	10
C76704	10
C76705	10
C76706	10
C76707	10
C76708	10
C76709	10
C76710	10
C76711	10
C76712	10
C76800	12
C76801	12
C76802	12
C76803	12
C76804	12
C76805	12
C76806	12
C76807	12
C76808	12
C76809	12
C76810	12
C76811	12
C76812	12
C76813	12
C76814	13
C76815	13
C76816	13
C76817	13
C76818	13
C76819	13
C76820	13
C76821	13
C76822	13
C76823	13
C76824	13
C76825	13
C76826	13
C76827	13
C76828	13
C76829	13
C76830	13
C76831	13
C76832	13
C76833	13
C76834	13
C76835	13
C76836	13
C76837	13
C76838	13
C76839	13
C76840	14

PART NO.	PG #
C76841	14
C76842	14
C76843	14
C76844	14
C76845	14
C76846	14
C76847	14
C76848	14
C76849	14
C76850	14
C76851	14
C76852	14
C76853	14
C76854	14
C76855	14
C76856	14
C76857	14
C76858	14
C76859	14
C76860	14
C76861	14
C76862	14
C76863	15
C76864	15
C76865	15
C76866	15
C76867	15
C76868	15
C76869	15
C76870	15
C76871	15
C76872	15
C76873	15
C76874	15
C76875	15
C76876	15
C76877	15
C76878	15
C76879	15
C76880	15
C76881	15
C76882	15
C76883	15
C76884	15
C76885	15
C76886	15
C76887	15
C76888	15
C76889	15
C76890	15
C76891	15
C76892	15
C76893	15
F40001	4
F40002	4
F40003	4
F40004	4
F40005	4

PART NO.	PG #
F40006	4
F40007	4
F40008	4
F40009	4
F40010	4
F40011	4
F40012	4
F40013	4
F40014	4
F40015	4
F40016	4
F40017	4
F40018	4
F40019	4
F40020	4
F40021	4
F40022	4
F40023	4
F40024	4
F40025	4
F40026	4
F40027	4
F40028	4
F40029	4
F40030	4
F40031	4
F40032	4
F40033	4
F40034	4
F40035	4
F40036	4
F40037	4
F40038	4
F40039	4
F40040	4
F40041	4
F40042	5
F40043	5
F40044	5
F40045	5
F40046	5
F40047	5
F40048	5
F40049	5
F40050	5
F40051	5
F40052	5
F40053	5
F40054	5
F40055	5
F40056	5
F40057	5
F40058	5
F40059	5
F40060	5
F40061	5
F40062	5
F40063	5

PART NO.	PG #
F40064	5
F40065	5
F40066	5
F40067	5
F40068	5
F40069	5
F40070	5
F40071	5
F40072	5
F40073	5
F40074	5
F40075	5
F40076	5
F40077	5
F40078	5
F40079	5
F40080	5
F40081	5
F40082	5
F40083	5
F40084	5
F40085	5
F40086	5
F40087	5
F40088	5
F40089	5
F40090	5
F40091	5
F40092	5
F40093	5
F40094	5
F40095	4
F40096	4
F40097	4
F40098	4
F40100	4
F40101	5
F40102	5
F40103	5
F40104	5
F40105	5
F40106	5
F40107	5
F40108	5
F40109	5
F40110	5
F40111	5
F40112	5
F40113	5
F40114	5
F40115	5
F40116	5
F40117	5
F40118	5
F40119	4
F40120	4
F40121	5
F40122	5

PART NO.	PG #
F40123	4
F40124	4
F40125	4
F40126	4
F40127	4
F40128	5
F40131	4
F40132	4
F40133	4
F40135	5
F401516	6
F41001	6
F41002	6
F41003	6
F41004	6
F41005	6
F41006	6
F41007	6
F41008	6
F41009	6
F41011	6
F41012	6
F41013	6
F411516	6
F461012	6
F46108	6
F481012	6
F48108	6
G04003	38
G04004	38
G08004	39
G08006	39
G08008	39
G08012	39
G08016	39
G08020	39
G08024	39
G09004	39
G09006	39
G09008	39
G09012	39
G09016	39
G09020	39
G09024	39
G10006	39
G10008	39
G10010	39
G10012	39
G10016	39
G10020	39
G10024	39
G10032	39
G10036	39
G10040	39
G10052	39
G10072	39
G10080	39
G10104	39

PART NO.	PG #
G11006	39
G11008	39
G11010	39
G11012	39
G11016	39
G11020	39
G11024	39
G11028	39
G11032	39
G11036	39
G11040	39
G11044	39
G11048	39
G11052	39
G11056	39
G11064	39
G11072	39
G11080	39
G11088	39
G11096	39
G11104	39
G14006	40
G14008	40
G14010	40
G14012	40
G14016	40
G14020	40
G14024	40
G14028	40
G14032	40
G14036	40
G14040	40
G14044	40
G14048	40
G14052	40
G14056	40
G14064	40
G14072	40
G14080	40
G14088	40
G14096	40
G14104	40
G15002	40
G15003	40
G15004	40
G15006	40
G15008	40
G17025	32
G17037	32
G17050	32
G17075	32
G17100	32
G17125	32
G17150	32
G17200	32
G18025	32
G18037	32
G18050	32

PART NO.	PG #
G18075	32
G18100	32
G18125	32
G18150	32
G18200	32
G19025	32
G19037	32
G19050	32
G19075	32
G19100	32
G19125	32
G19150	32
G19200	32
G20002	23
G20003	23
G20004	23
G20005	23
G20006	24
G20008	23
G20010	23
G20011	23
G20015	23
G20016	23
G20017	23
G20020	23
G20021	23
G20030	23
G20031	23
G20032	23
G20035	23
G20036	23
G20037	23
G20038	23
G20040	24
G20041	24
G20042	24
G20043	24
G20045	24
G20047	24
G20050	24
G20051	24
G20052	24
G20053	24
G20054	24
G20055	24
G20056	24
G20057	24
G20057R	24
G20058	38
G20060	24
G20102	23
G20103	23
G20108	23
G20110	23
G20111	23
G20115	23
G20116	23
G20120	23

PART NO.	PG #
G20121	23
G20130	23
G20131	23
G20132	23
G20136	23
G20137	23
G20138	23
G20141	24
G20142	24
G20143	24
G20150	24
G20155	24
G24004	25
G24006	25
G25022	25
G25032	25
G25034	25
G25042	25
G25044	25
G25046	25
G25048	25
G25052	25
G25054	25
G25056	25
G25062	25
G25064	25
G25066	25
G25068	25
G25084	25
G25086	25
G25088	25
G25101	25
G25106	25
G25108	25
G25121	25
G25128	25
G25161	25
G25169	25
G25612	25
G25812	25
G26022	25
G26032	25
G26034	25
G26042	25
G26044	25
G26046	25
G26052	25
G26054	25
G26056	25
G26062	25
G26064	25
G26066	25
G26068	25
G26084	25
G26086	25
G26088	25
G26121	25
G26161	25

PART NO.	PG #
G27042	25
G27044	25
G27054	25
G27062	25
G27064	25
G27066	25
G27068	25
G27084	25
G27086	25
G27088	25
G27106	25
G27108	25
G28044	25
G28066	25
G28088	25
G29003	25
G29004	25
G29005	25
G29006	25
G29008	25
G29010	25
G51001	41
G51002	41
G51003	41
G51004	41
G51005	41
G51006	41
G51008	41
G51010	41
G51012	41
G51013	41
G51015	41
G51025	41
G51035	41
G51050	41
G51075	41
G51102	42
G51103	42
G51104	42
G51105	42
G51106	42
G51108	42
G51110	42
G51112	42
G51125	42
G51135	42
G52001	41
G52002	41
G52003	41
G52004	41
G52005	41
G52006	41
G52008	41
G52010	41
G52012	41
G52013	41
G52015	41
G52025	41

PART NO	PAGE
PART NO.	PG #
G52035	41
G52075	41
G52102	42
G52103	42
G52104	42
G52105	42
G52106	42
G52108	42
G52110	42
G52115	42
G52125	42
G53001	41
G53002	41
G53003	41
G53004	41
G53005	41
G53006	41
G53008	41
G53010	41
G53012	41
G53013	41
G53015	41
G53025	41
G53035	41
G53050	41
G53075	41
G53101	42
G53102	42
G53103	42
G53104	42
G53105	42
G53106	42
G53108	42
G53110	42
G53113	42
G53115	42
G53125	42
G53203	42
G53204	42
G53206	42
G53215	42
G53225	42
G54001	41
G54002	41
G54003	41
G54004	41
G54005	41
G54006	41
G54008	41
G54010	41
G54012	41
G54013	41
G54015	41
G54025	41
G54035	41
G54075	41
G54102	42

PART NO	PAGE
PART NO.	PG #
G54103	42
G54104	42
G54105	42
G54106	42
G54108	42
G54110	42
G54112	42
G54115	42
G54125	42
G54202	42
G54203	42
G54204	42
G54205	42
G54206	42
G54208	42
G54210	42
G54212	42
G54215	42
G54225	42
G55001	43
G55002	43
G55003	43
G55004	43
G55005	43
G55014	43
G55016	43
G55018	43
G55116	43
G55118	43
G55150	42
G55200	42
G55250	42
G55300	42
G55350	42
G55400	42
G55450	42
G55500	42
G55550	42
G55600	42
I10001	28
I10002	28
I10003	28
I10004	28
I10005	28
I10006	28
I10007	28
I10008	28
I10009	28
I10010	28
I10011	28
I10012	28
I10013	28
I10014	28
I10015	28
I10016	28
I10017	28
I10018	28

PART NO	PAGE
PART NO.	PG #
I10019	28
I10020	28
I10021	28
I10022	28
I10023	28
I10024	28
I10025	28
I10026	28
I10027	28
I10028	28
I10029	28
I10030	28
I10031	28
I10032	28
I10033	28
I10034	28
I10035	28
I10036	28
I10037	28
I10038	28
I10039	28
I10040	28
I10041	28
I10042	28
I10043	28
I10044	28
I10045	28
I10046	28
I10047	28
I10048	28
I10049	28
I11001	27
I11002	27
I11003	27
I11004	27
I11005	27
I11006	27
I11007	27
I11008	27
I11009	27
I11010	27
I11011	27
I11012	27
I11013	27
I11014	27
I11015	27
I11016	27
I11017	27
I11018	27
I11019	27
I11020	27
I11021	27
I11022	27
I11023	27
I11024	27
I11025	27
I11026	27

PART NO.	PG #
I11027	27
I11028	27
I12001	30
I12002	30
I12003	30
I12004	30
I12005	30
I12006	30
I12007	30
I12008	30
I12009	30
I12010	30
I12011	30
I12012	30
I12013	30
I12014	30
I12015	30
I12016	30
I12017	30
I12018	30
I13001	29
I13002	29
I13003	29
I13004	29
I13005	29
I13006	29
I13007	29
I13008	29
I13009	29
I13010	29
I13011	29
I13012	29
I13013	29
I13014	29
I13015	29
I13016	29
I13017	29
I13018	29
I13019	29
I13020	29
I13021	29
I13022	29
I13023	29
I13024	29
I13025	29
I13026	29
I13027	29
I13028	29
I13029	29
I13030	29
I13031	29
I13032	29
I13033	29
I13034	29
I13035	29
I13036	29
I13037	29
I13038	29

PART NO.	PG #	PART NO.	PG #	PART NO.	PG #	PART NO.	PG #
I13039	29	N10364	31	N15550	21	N20012	16
I13040	29	N10442	31	N15600	21	N20014	16
I13041	29	N10444	31	N15900	21	N20016	16
I13042	29	N10464	31	N15918	21	N20018	16
N01001	33	N10544	31	N15924	21	N20020	16
N01002	33	N10566	31	N15936	21	N20022	16
N01005	33	N10642	31	N15948	21	N21000	16
N01006	33	N10644	31	N15960	21	N21001	16
N01007	32	N10664	31	N15972	21	N21002	16
N01008	32	N10722	31	N16100	21	N21003	16
N01009	32	N10744	31	N16150	21	N21004	16
N01010	32	N10822	31	N16200	21	N21005	16
N01011	32	N10844	31	N16250	21	N21006	16
N01012	32	N10922	31	N16300	21	N21007	16
N01013	32	N10944	31	N16350	21	N21008	16
N01014	32	N11001	26	N16400	21	N21009	16
N01015	32	N11002	26	N16450	21	N21010	16
N01016	32	N11003	26	N16500	21	N21012	16
N01017	32	N11004	26	N16550	21	N21014	16
N01018	32	N11005	26	N16600	21	N21016	16
N01020	32	N11006	26	N16900	21	N21018	16
N01021	32	N11007	26	N16918	21	N21020	16
N01022	32	N11008	26	N16924	21	N21022	16
N01023	32	N12001	26	N16936	21	N22000	16
N01024	32	N12002	26	N16948	21	N22001	16
N01025	32	N12003	26	N16960	21	N22002	16
N01026	32	N12004	26	N16972	21	N22003	16
N01027	32	N12005	26	N17100	21	N22004	16
N01028	32	N12006	26	N17150	21	N22005	16
N01029	32	N14001	26	N17200	21	N22006	16
N01030	33	N14002	26	N17250	21	N22007	16
N01031	33	N14003	26	N17300	21	N22008	16
N01032	33	N14004	26	N17350	21	N22009	16
N01033	33	N14005	26	N17400	21	N22010	16
N01034	33	N14006	26	N17450	21	N22012	16
N01035	33	N14007	26	N17500	21	N22014	16
N01037	33	N14008	26	N17550	21	N22016	16
N01038	31	N14009	26	N17600	21	N22018	16
N01039	31	N14010	26	N18001	26	N22020	16
N01040	32	N14011	26	N18002	26	N22022	16
N06001	26	N14012	26	N18100	21	N23000	16
N07001	26	N14013	26	N18200	21	N23001	16
N09001	26	N14014	26	N18250	21	N23002	16
N09002	26	N14015	26	N18300	21	N23003	16
N10001	26	N14016	26	N18400	21	N23004	16
N10002	26	N14017	26	N18500	21	N23005	16
N10003	26	N14018	26	N18600	21	N23006	16
N10004	26	N14019	26	N20000	16	N23007	16
N10005	26	N15001	26	N20001	16	N23008	16
N10006	26	N15100	21	N20002	16	N23009	16
N10007	26	N15150	21	N20003	16	N23010	16
N10008	26	N15200	21	N20004	16	N23012	16
N10142	31	N15250	21	N20005	16	N23014	16
N10164	31	N15300	21	N20006	16	N23016	16
N10244	31	N15350	21	N20007	16	N23018	16
N10266	31	N15400	21	N20008	16	N23020	16
N10342	31	N15450	21	N20009	16	N23022	16
N10344	31	N15500	21	N20010	16	N24000	16

PART NO.	PG #
N24001	16
N24002	16
N24003	16
N24004	16
N24005	16
N24006	16
N24007	16
N24008	16
N24009	16
N24010	16
N24012	16
N24014	16
N24016	16
N24018	16
N24020	16
N24022	16
N25000	16
N25002	16
N25003	16
N25004	16
N25005	16
N25006	16
N25007	16
N25008	16
N25009	16
N25010	16
N25012	16
N25014	16
N25016	16
N25018	16
N25020	16
N25022	17
N27000	17
N27002	17
N27003	17
N27004	17
N27005	17
N27006	17
N27007	17
N27008	17
N27009	17
N27010	17
N27012	17
N27014	17
N27016	17
N27018	17
N27020	17
N27022	17
N28000	17
N28002	17
N28003	17
N28004	17
N28005	17
N28006	17
N28007	17
N28008	17
N28009	17
N28010	17

PART NO.	PG #
N28012	17
N28014	17
N28016	17
N28018	17
N28020	17
N28022	17
N29000	17
N29003	17
N29004	17
N29005	17
N29006	17
N29007	17
N29008	17
N29009	17
N29010	17
N29012	17
N29014	17
N29016	17
N29018	17
N29020	17
N29022	17
N30000	17
N30004	17
N30005	17
N30006	17
N30007	17
N30008	17
N30009	17
N30010	17
N31000	17
N31004	17
N31005	17
N31006	17
N31007	17
N31008	17
N31009	17
N31010	17
N61010	3
N62006	3
N62008	3
N62010	3
N62086	3
N62106	3
N62108	3
N65106	3
N66066	3
N66068	3
N66086	3
N66088	3
N66610	3
N68066	3
N68068	3
N68086	3
N68088	3
N69066	3
N69068	3
N69086	3
N69088	3

PART NO.	PG #
N70066	3
N70068	3
N70086	3
N70088	3
N78064	31
N78084	31
N78104	31
P10012	7
P10014	7
P10016	7
P10018	7
P10032	7
P10034	7
P10036	7
P10038	7
P10082	7
P10084	7
P10086	7
P10088	7
P10092	7
P10094	7
P10096	7
P10098	7
P10312	7
P10452	7
P10454	7
P10812	7
P10912	7
P11042	8
P11062	8
P11064	8
P11082	8
P11084	8
P11086	8
P11102	8
P11104	8
P11106	8
P11108	8
P11122	8
P11124	8
P11126	8
P11128	8
P11202	8
P11204	8
P11206	8
P11208	8
P11212	8
P11928	8
P11964	8
P11986	8
P12102	7
P12104	7
P12106	7
P12108	7
P12112	7
P12202	8
P12204	8
P12206	8

PART NO.	PG #
P12208	8
P12212	8
P12328	8
P12342	8
P12362	8
P12364	8
P12384	8
P12386	8
P12402	7
P12404	7
P12406	7
P12408	7
P13224	8
P13232	8
P13424	8
P13432	8
P13624	8
P13632	8
P13986	7
P16002	7
P16004	7
P16006	7
P16008	7
P19042	7
P19062	7
P19064	7
P19082	7
P19084	7
P19086	7
P19128	7
P20002	7
P20004	7
P20006	7
P20008	7
P20092	8
P20094	8
P20096	8
P20098	8
R20001	36
R20002	36
R20003	36
S92001	31
S92025	31
S92030	31
S92031	31
T73125	3
T73138	3
T73150	3
T73175	3
T73200	3



SECTION E - RESIDENTIAL & COMMERCIAL PLASTIC

VOLUME V



Quality
Products *for*
the Plumbing
Professional

Closet Flanges & Accessories	2-5
Residential Drains	6-13
Commercial Drain Bases.....	14-16
Commercial Spuds & Strainers	17-19
Commercial Drains.....	20-49
Residential & Light Commercial Cleanouts	50-52
Cleanout Spuds.....	53-54
Commerical Cleanouts.....	55-60
Floor Sinks & Accessories	61-62
Roof Drains.....	63
Product Index.....	64-65
Part Number Index.....	66-76

Plumbfit Closet Flange

3" x 4" Fits Flush with Floor
3" Fits Inside 3" Schedule 40 DWV Pipe

MADE IN THE
USA



- Long shank
- Six screw holes
- Extra-thick flange with short slots for extra strength
- For 3" units cut pipe 1/8" below floor and remove concrete so unit will fit flush
- 3" has 4 closet bolt slots



PART NO.	DESCRIPTION	MATERIAL	CTN QTY
C51300	3" less knockout	PVC	20
C51301	3" less knockout	ABS	20
C50300	3" with Knockout	PVC	20
C50301	3" with Knockout	ABS	20
C51340	3" x 4" less knockout	PVC	20
C51341	3" x 4" less knockout	ABS	20
C50340	3" x 4" with knockout	PVC	20
C50341	3" x 4" with knockout	ABS	20

Plumbfit Closet Flange

Fits Over 4" Schedule 40 DWV Pipe

MADE IN THE
USA



- Extra thick flange with short slots for extra strength
- Six screw holes
- Long shank



PART NO.	DESCRIPTION	MATERIAL	CTN QTY
C51400	4" less knockout	PVC	20
C51401	4" less knockout	ABS	20
C50400	4" with knockout	PVC	20
C50401	4" with knockout	ABS	20

Plumbfit Closet Flange w/Metal Rings

Fits Over 3" or Inside 4" Schedule 40 DWV Pipe
4" Fits Over 4" Schedule 40 DWV Pipe

MADE IN THE
USA



- Adjustable metal ring
- Two radial slots for closet bolts



PART NO.	DESCRIPTION	MATERIAL	CTN QTY
C53340	3" x 4" less knockout	PVC	40
C53341	3" x 4" less knockout	ABS	40
C52340	3" x 4" with knockout	PVC	40
C52341	3" x 4" with knockout	ABS	40
C53400	4" less knockout	PVC	20
C53401	4" less knockout	ABS	20
C52400	4" with knockout	PVC	20
C52401	4" with knockout	ABS	20

Plumbfit Closet Flange with SS Ring

MADE IN THE
USA



- Exclusive 400 grade stainless with plumb fit bodies
- Radial slots for closet bolts; 6 screw holes
- For Schedule 40 DWV pipe



PART NO.	DESCRIPTION	MATERIAL	CTN QTY
C57234	Inside 3" pipe; 4" long shank less knockout	PVC	20
C58234	Inside 3" pipe; 4" long shank less knockout	ABS	20
C57236	Inside 3" pipe; 6" long shank less knockout	PVC	20
C58236	Inside 3" pipe; 6" long shank less knockout	ABS	20
C57134	Over 3" inside 4" less knockout	PVC	20
C58134	Over 3" inside 4" less knockout	ABS	20
C57034	Over 3" inside 4" with knockout	PVC	20
C58034	Over 3" Inside 4" with knockout	ABS	20
C57334	Over 3" Inside 4"; 6" long shank less knockout	PVC	20
C58334	Over 3" Inside 4"; 6" long shank less knockout	ABS	20
C57040	Over 4" pipe with knockout	PVC	20
C58040	Over 4" pipe with knockout	ABS	20
C57140	Over 4" pipe less knockout	PVC	20
C58140	Over 4" pipe less knockout	ABS	20

Offset Plumbfit Closet Flange w/SS Ring

MADE IN THE
USA



- Exclusive 400 grade stainless with plumb fit bodies
- Radial slots for closet bolts; 6 screw holes
- For Schedule 40 DWV pipe



PART NO.	DESCRIPTION	MATERIAL	CTN QTY
C57434	Over 3" Inside 4"; offset less knockout	PVC	20
C58434	Over 3" Inside 4"; offset less knockout	ABS	20

Spigot Fit Closet Flange

MADE IN THE
USA



- Extra-thick flange with short slots for extra strength
- Six screw holes

PART NO.	DESCRIPTION	MATERIAL	CTN QTY
C51350	3" less knockout	PVC	20
C51351	3" less knockout	ABS	20
C51450	4" less knockout	PVC	20
C51451	4" less knockout	ABS	20

Plumbfit Closet Flanges w/Adj. Rings

Fits Over 3" and Inside 4" Schedule 40 DWV Pipe

MADE IN THE
USA



- 6" long shank
- Can be cut to desired length
- Swivel rings

PART NO.	DESCRIPTION	SHANK LENGTH	MATERIAL	CTN QTY
C53600	Metal Ring	6"	PVC	1
C53601	Metal Ring	6"	ABS	1
C53700	Plastic ring	6"	PVC	1
C53701	Plastic ring	6"	ABS	1

3" Closet Flange with Long Barrel

Fits Inside 3" Schedule 40 DWV

MADE IN THE
USA



- Adjustable swivel rings

PART NO.	DESCRIPTION	SHANK LENGTH	MATERIAL	CTN QTY
C50302	3" Metal ring	4"	PVC	1
C50303	3" Metal ring	4"	ABS	1
C50306	3" Plastic ring	4"	PVC	1
C50307	3" Plastic ring	4"	ABS	1
C50304	3" Metal ring	6"	PVC	1
C50305	3" Metal ring	6"	ABS	1
C50308	3" Plastic ring	6"	PVC	1
C50309	3" Plastic ring	6"	ABS	1

Plastic Two Finger Flange

MADE IN THE
USA



- Flush fit
- Patent #: 5,937,450
- Will fit oblong horns
- Pushes easily into 3" or 4" cast iron or Schedule 40 DWV pipe
- ASTM C-564 rubber gasket



PART NO.	DESCRIPTION	MATERIAL	CTN QTY
C4733P	3" x 3"	PVC	6
C4733A	3" x 3"	ABS	6
C4743P	4" x 3"	PVC	6
C4743A	4" x 3"	ABS	6

Closeout Flange w/3-1/2" Extended Threads

MADE IN THE
USA



PART NO.	DESCRIPTION	MATERIAL	CTN QTY
C54150	with 3-1/2" extended threads	PVC	1

Plumbfit Closet Flanges with Plastic Swivel Ring

3" x 4" Fits Over 3" or Inside 4" Schedule 40 DWV Pipe

MADE IN THE
USA



- Plastic ring will not deteriorate
- 360° rotation
- 2 radial slots and 2 grooved slots for closet bolts
- 6 screw holes for securing to floor



PART NO.	DESCRIPTION	MATERIAL	CTN QTY
C53342	3" x 4" less knockout	PVC	6
C53343	3" x 4" less knockout	ABS	6
C54402	3" x 4" offset - less knockout	PVC	6
C54403	3" x 4" offset - less knockout	ABS	6
C52342	3" x 4" with knockout	PVC	6
C52343	3" x 4" with knockout	ABS	6

Plumbfit Offset Closet Flanges with Plastic Swivel Ring

4" Fits Over Schedule 40 DWV Pipe

MADE IN THE
USA



- Plastic ring will not deteriorate
- 360° rotation
- 2 radial slots and 2 grooved slots for closet bolts
- 6 screw holes for securing to floor



PART NO.	DESCRIPTION	MATERIAL	CTN QTY
C52402	4" with knockout	PVC	6
C52403	4" with knockout	ABS	6
C53402	4" less knockout	PVC	6
C53403	4" less knockout	ABS	6

45° Closet Flange

Fits Over 3" DWV with a 4" Sweep



- CSA listed
- With plastic swivel ring
- More versatile than an offset closet flange
- Provides unlimited offset when used in conjunction with a socket x socket 45° elbow



PART NO.	DESCRIPTION	MATERIAL	CTN QTY
C55043	3" with Plastic ring	PVC	20
C55143	3" with Plastic ring	ABS	20

Offset Closet Flange

Fits Over 3" or Inside 4" Schedule 40 DWV Pipe

MADE IN THE
USA



- 2" Offset
- Four closet bolt slots and two mounting screw holes



PART NO.	DESCRIPTION	MATERIAL	CTN QTY
C54340	3" x 4"	PVC	20
C54341	3" x 4"	ABS	20

Offset Closet Flange with Metal Ring

Fits Over 3" or Inside 4" Schedule 40 DWV Pipe

MADE IN THE
USA



- Adjustable metal ring
- Two radial slots for closet bolts



PART NO.	DESCRIPTION	MATERIAL	CTN QTY
C54400	3" x 4" less knockout	PVC	20
C54401	3" x 4" less knockout	ABS	20

4-Way Offset Closet Flange

Fits Over 3" or Inside 4" Schedule 40 DWV Pipe

MADE IN THE
USA



- 2" Offset
- 1-13/16" barrel depth



PART NO.	DESCRIPTION	MATERIAL	CTN QTY
C54342	3" x 4"	PVC	20
C54343	3" x 4"	ABS	20

3" Over Schedule 30 Pipe Closet Flange

MADE IN THE
USA



PART NO.	DESCRIPTION	MATERIAL	CTN QTY
C51150	3" less knockout	PVC	1
C52150	3" with knockout	PVC	1

Closet Flange Extenders

MADE IN THE
USA



- Stackable to desired height
- For raising floor height when adding ceramic tile or hardwood

PART NO.	DESCRIPTION	MATERIAL	CTN QTY
C88001	1/2" Thick	PVC	20
C88501	1/4" Thick	PVC	20

Waxless Gasket

MADE IN THE
USA



- Reusable
- Seals closet flange without using wax

PART NO.	DESCRIPTION	CTN QTY
C88002	Waxless gasket	1

Closet Flange Rings

MADE IN THE
USA



- Fits over 3" or 4" PVC
- Converts 3 and 4" PVC pipe into a toilet ready application

PART NO.	DESCRIPTION	MATERIAL	CTN QTY
C51302	3" Ring	PVC	10
C51303	3" Ring	ABS	10
C51402	4" Ring	PVC	10
C51403	4" Ring	ABS	10

Closet Flange Repair Ring



- Securely attaches to concrete or wood sub-floor
- Replaces most closet rings
- Corrosion resistant
- Mounting ears offset by 1/8" to allow closet bolts to be installed

PART NO.	DESCRIPTION	CTN QTY
C85000	Closet flange repair ring	6

Complete Closet Flange Extension Kit with Gaskets

MADE IN THE
USA



- Useful when overlaying, replacing or tiling bathroom floors
- Two 3-1/2" closet bolts with washers and nuts
- Anchors toilet bolts when closet ring is broken
- No caulking required
- Has built-in gaskets
- One 1/4" flange & One 1/2" flange

PART NO.	DESCRIPTION	MATERIAL	CTN QTY
C88500	Complete Kit		10
C88502	Kit less bolts		10

Complete Closet Flange Extension Kit

MADE IN THE
USA



- Three 1/4" extenders for easy adjustment
- Two 3-1/2" closet bolts with washers and nuts
- Adhesive caulk and all hardware included

PART NO.	DESCRIPTION	CTN QTY
C88500C	Complete Kit	10

Closet Flange Extension Kit

MADE IN THE
USA



- No mastic necessary between pieces as with stackable units
- Heavy solid plastic construction
- Two 3-1/2" closet bolts with washers and nuts
- Packaged in display header bag
- One 1/2" flange

PART NO.	DESCRIPTION	CTN QTY
C88050	1/2"	10

Closest Flange Spacer Kit



MADE IN THE
USA

- Reusable toilet seal gasket
- For repair or correction of problems resulting from installation errors or remodeling projects
- Complete kit includes: 2 gaskets, 1/2" spacer, 1/4" x 3-1/2" closet bolt kit, 2 plastic shims

PART NO.	DESCRIPTION	CTN QTY
C88600	1" repair ring	1

Gapper Flange



- Used to repair broken closet flanges
- Individually carded for easy display or bulk

PART NO.	DESCRIPTION	CTN QTY
C87100	Repair flange carded	2

Flexible and Rigid Super Shims

MADE IN THE
USA



- Stackable
- Rigid, can be driven
- Flexible, can be trimmed
- Priced per bag
- 10 per bag

PART NO.	DESCRIPTION	CTN QTY
S55950	1-1/8" x 1-15/16" x 1/4" flexible	1 bag of 10
S55951	1-1/8" x 1-15/16" x 1/4" rigid	1 bag of 10

Flexible Super Shims

MADE IN THE
USA



- 200 Flexible super shims packaged in a convenient refillable "candy bowl" counter display
- Priced per display

PART NO.	DESCRIPTION	CTN QTY
S55952	200 Flexible super shims	1 bowl of 200

Rigid Super Shims

MADE IN THE
USA



- 200 Rigid super shims packaged in a convenient refillable "candy bowl" counter display
- Priced per display

PART NO.	DESCRIPTION	CTN QTY
S55953	200 Rigid super shims	1 bowl of 200

Closest Wedge Shims

MADE IN THE
USA



- Stackable
- 3/8" width x 1-3/8" length x 5/16" height
- Easily trimmed to desired height
- Priced per bag or display

PART NO.	DESCRIPTION	CTN QTY
S55902	100 shims poly bagged	1 bag of 100
S55903	1000 shims counter display	1 bag of 100

Shower/Floor Drains

Fits Over 2" or Inside 3" Schedule 40 DWV Pipe

MADE IN THE
USA



- Low profile for first and second floor installations
- Beveled edge allows for recessed installation
- Reversible clamping ring for additional 1/2" height adjustment
- Brass inserts ensure secure clamping of membrane
- Dual weeps holes
- Recessed sump area for added drainage

PART NO.	MATERIAL	STRAINER	REPL. STRAINER	CTN QTY
D50001	PVC	4"SS	C60809	20
D50301	ABS	4" SS	C60809	20
D50002	PVC	4"PB	C60810	20
D50302	ABS	4" PB	C60810	20
D50132	PVC	4" PB cast	C60807	20
D50332	ABS	4" PB cast	C60807	20
D50133	PVC	4" PB cast w/ring	C60807/C60824	20
D50333	ABS	4" PB cast w/ring	C60807/C60824	20
D50130	PVC	4" NB cast	C60808	20
D50330	ABS	4" NB cast	C60808	20
D50131	PVC	4" NB cast w/ring	C60808/C60825	20
D50331	ABS	4" NB cast w/ring	C60808/C60825	20
D50011	PVC	4" CP cast	C60806	20
D50311	ABS	4" CP cast	C60806	20
D50010	PVC	4" CP cast w/ring	C60806/C60818	20
D50310	ABS	4" CP cast w/ring	C60806/C60818	20
D50134	PVC	4" CP cast square	C60812	20
D50334	ABS	4" CP cast square	C60812	20
D50135	PVC	4" PB cast square	C60813	20
D50335	ABS	4" PB cast square	C60813	20
D50120	PVC	2" x 3" SS w/PT	C60809	1
D50121	PVC	2" x 3" PB w/PT	C60810	1
D50122	PVC	2" x 3" PB cast w/PT	C60807	1
D50123	PVC	2" x 3" CP cast w/PT	C60806	1
D50124	PVC	2" x 3" NB cast w/PT	C60808	1

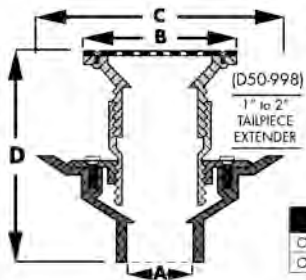

- Use **D50998** Tailpiece Extension (listed below) when additional height is needed.

A	B	C	D
Over 2" pipe	4-1/4"	6-1/2"	3-1/4" - 4-3/8"
Over 3" pipe	4-1/4"	6-1/2"	3-1/4" - 4-3/8"

Tailpiece Extension

MADE IN THE
USA



- Use when additional height is needed
- Compensates for thick shower bases

PART NO.	DESCRIPTION	CTN QTY
D50998	1" - 2" tailpiece extension	1

Shower/Floor Drains w/Brass Tailpiece

Fits Over 2" or Inside 3" Schedule 40 DWV Pipe

MADE IN THE
USA



BRASS TAILPIECE

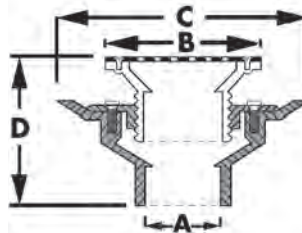

- Low profile for first and second floor installations
- Beveled edge allows for recessed installation
- Reversible clamping ring for additional 1/2" height adjustment
- Brass inserts ensure secure clamping of membrane
- Dual weeps holes
- Recessed sump area for added drainage

A	B	C	D
Over 2" pipe	4-1/4"	6-1/2"	3-1/4" - 4-3/8"
Over 3" pipe	4-1/4"	6-1/2"	3-1/4" - 4-3/8"

PART NO.	MATERIAL	STRAINER	REPL. STRAINER	CTN QTY
D50101	PVC	4" SS	D60780	20
D50401	ABS	4" SS	D60780	20
D50111	PVC	4" CP	D60781	20
D50411	ABS	4" CP	D60781	20
D50102	PVC	4" PB	D60782	20
D50402	ABS	4" PB	D60782	20
D50800	PVC	6" CP	-	20
D50830	ABS	6" CP	-	20
D50802	PVC	6" PB	-	20
D50832	ABS	6" PB	-	20
D50161	PVC	4" CP square	C60812	20
D50162	ABS	4" CP square	C60812	20
D50152	PVC	4" PB square	C60813	20
D50153	ABS	4" PB square	C60813	20

Brass Drain Extension



- 2" MIP x 2" FIP for 2" drain spuds
- Use when additional height is required to overcome inconsistent concrete pours
- Height extension from 1-1/2" to 3-1/2"
- Solid brass construction

PART NO.	DESCRIPTION	CTN QTY
D60978	Brass drain extension	1

"Perfect Low Profile" Drain

Fits Over 2" or Inside 3" PVC Schedule 40 DWV Pipe

MADE IN THE **USA**

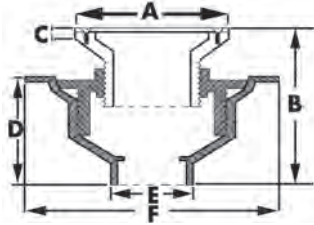

- 3" total height; perfect for multiple stories
- Reversible clamping ring, stainless steel strainer

A	B	C	D	E	F
4-1/4"	MIN: 3" - MAX: 4-1/4"	3/8"	2"	ID: 2-3/8" OD: 3-1/16"	6-5/8"

PART NO.	DESCRIPTION	MATERIAL	CTN	QTY
D50PLP	"Perfect low profile" drain	PVC	20	

PVC Low Profile Drain

MADE IN THE **USA**

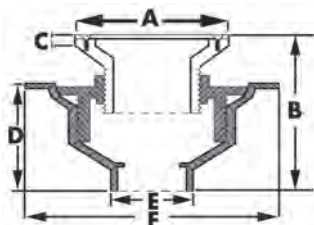

- Primer tapped

A	B	C	D	E	F
4-1/4"	MIN: 3" - MAX: 4-1/4"	3/8"	2"	ID: 2-3/8" OD: 3-1/16"	6-5/8"

PART NO.	DESCRIPTION	MATERIAL	CTN	QTY
D50125	2" x 3" with SS strainer	PVC	1	
D50126	2" x 3" with NB cast strainer	PVC	1	

Shower/Floor Drains with Plastic Tailpiece

Fits Over 2" Schedule 40 DWV Pipe

MADE IN THE **USA**

**COVERALL TOPS
PLASTIC TAILPIECE**



- Screw-down clamping ring has weep holes for secondary drainage

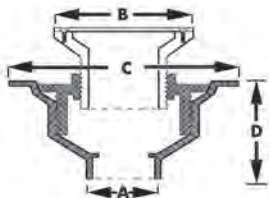

A	B	C	D
Over 2" pipe	4-1/4"	7"	3-5/8" - 5-1/8"
With Ring	4-1/4"	7"	3-3/4" - 5-1/4"

PART NO.	DESCRIPTION	MATERIAL	CTN	QTY
D50700	4" SS strainer	PVC	10	
D50703	4" SS strainer	ABS	10	
D50702	4" PB strainer	PVC	10	
D50705	4" PB strainer	ABS	10	
D50708	4" PB strainer cast	PVC	10	
D50726	4" PB strainer cast	ABS	10	
D50709	4" PB strainer with ring	PVC	10	
D50727	4" PB strainer with ring	ABS	10	
D50701	4" CP strainer	PVC	10	
D50704	4" CP strainer	ABS	10	
D50706	4" NB strainer	PVC	10	
D50724	4" NB strainer	ABS	10	
D50707	4" NB strainer with ring	PVC	10	
D50725	4" NB strainer with ring	ABS	10	

Shower/Floor Drains with Brass Tailpiece

Fits Over 2" Schedule 40 DWV Pipe

MADE IN THE **USA**

**COVERALL TOPS
BRASS TAILPIECE**



- Screw-down clamping ring has weep holes for secondary drainage

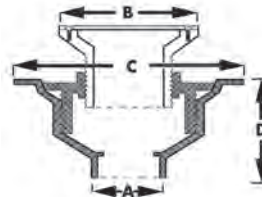

A	B	C	D
Over 2" pipe	4-1/8" or 6"	7"	3-5/8" - 5-1/4"

PART NO.	DESCRIPTION	MATERIAL	CTN	QTY
D50710	4" SS strainer	PVC	10	
D50713	4" SS strainer	ABS	10	
D50712	4" PB strainer	PVC	10	
D50715	4" PB strainer	ABS	10	
D50711	4" CP strainer	PVC	10	
D50714	4" CP strainer	ABS	10	
D50721	6" PB strainer	PVC	10	
D50723	6" PB strainer	ABS	10	
D50720	6" CP strainer	PVC	10	
D50722	6" CP strainer	ABS	10	

No Caulk Shower Drains

Pushes Over 2" DWV Pipe

MADE IN THE **USA**

**COVERALL TOPS
NO CAULK**



- Tongue-and-grooved beveled clamping ring
- Brass inserts
- Supplied with gasket

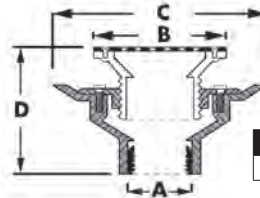

A	B	C	D
2" no caulk	4-1/4"	6-1/2"	3-1/2" - 4-3/4"

Plastic Tailpiece				
PART NO.	DESCRIPTION	MATERIAL	CTN	QTY
D50500	SS Strainer	PVC	10	
D50510	CP Strainer	PVC	10	

Brass Tailpiece				
PART NO.	DESCRIPTION	MATERIAL	CTN	QTY
D50501	SS Strainer	PVC	10	
D50502	PB Strainer	PVC	10	
D50511	CP Strainer	PVC	10	

No Caulk Shower Stall Drains

Fits Over 2" Schedule 40 DWV Pipe

**COVERALL TOPS
NO CAULK**

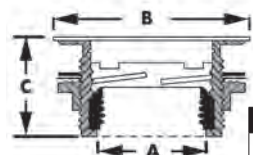

- Snap-in strainer
- Wrench included
- For 2" CTS order gasket separately

A	B	C
2"	4-1/4"	2"

Plastic Body

PART NO.	DESCRIPTION	CTN QTY
D40101	SS Strainer (101PNC) with plastic body	20
D40151	White plastic strainer with plastic body	20
D40201	PB strainer with plastic body	10
D40401	White epoxy coated SS str. with plastic body	10

Brass Body

PART NO.	DESCRIPTION	CTN QTY
D40140	SS Strainer (140NC) with brass body	20
D40240	PB strainer with brass body	10
D40440	White epoxy coated SS str. with brass body	10

Snap-in Replacement Strainers

PART NO.	DESCRIPTION	CTN QTY
D40005	SS replacement strainer for solvent outlet drains	1
D40003	PB replacement strainer	1
D40004	White epoxy coated SS replacement strainer	1
D40006	Replacement Wrench key	1
D40007	2" Schedule 40 DWV gasket	1
D40008	2" CTS replacement gasket	1
D40009	White plastic replacement strainer	1
D40010	SN replacement strainer	1

Shower Stall Drains with Receptor Base

Fits Over 2" Schedule 40 DWV Pipe

RECEPTOR BASE

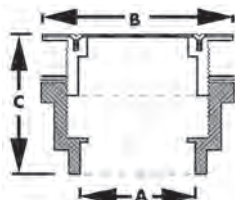

- Allows for secondary drainage
- Accepts knockout test cap for testing

A	B	C
2"	4-1/4"	2"

PART NO.	DESCRIPTION	MATERIAL	CTN QTY
D41001	2" Pipe size with SS strainer	PVC	25
D41301	2" Pipe size with SS strainer	ABS	20
D41002	2" Pipe size with PB strainer	PVC	20
D41302	2" Pipe size with PB strainer	ABS	20
D41003	2" Pipe size with AB strainer	PVC	20
D41303	2" Pipe size with AB strainer	ABS	20
D41004	2" Pipe size with SN strainer	PVC	20

2" Offset

PART NO.	DESCRIPTION	MATERIAL	CTN QTY
D41600	2" Offset with SS strainer	PVC	20
D41601	2" Offset with SS strainer	ABS	20

Replacement Strainers with Screws

PART NO.	DESCRIPTION	CTN QTY
D41101	SS replacement strainer with screws	1
D41102	PB replacement strainer with screws	1
D41106	AB replacement strainer with screws	1
D41107	SN replacement strainer with screws	1

General Purpose Drains

2" x 3" Fits Over 2" or Inside 3" Schedule 40 DWV Pipe

MADE IN THE
USA

COVERALL TOPS

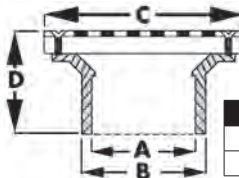

- Brass inserts

A	B	C	D
Less rings: Over 2" pipe	Inside 3" pipe	4-1/4"	2"
With rings: Over 2" pipe	Inside 3" pipe	4-1/2"	2-1/4"

PART NO.	DESCRIPTION	MATERIAL	CTN QTY
D54001	with SS strainer	PVC	20
D54301	with SS strainer	ABS	20
D54013	with NB strainer	PVC	20
D54313	with NB strainer	ABS	20
D54014	with NB strainer with ring	PVC	20
D54314	with NB strainer with ring	ABS	20
D54002	with CP strainer	PVC	20
D54302	with CP strainer	ABS	20
D54022	with CP strainer with ring	PVC	20
D54319	with CP strainer with ring	ABS	20
D54015	PB stamped strainer (PVD finish)	PVC	20
D54315	PB stamped strainer (PVD finish)	ABS	20
D54011	PB cast strainer	PVC	20
D54311	PB cast strainer	ABS	20
D54012	PB cast strainer with ring	PVC	20
D54312	PB cast strainer with ring	ABS	20

Drop-in Shower Stall Drains

Fits Over 2" Schedule 40 DWV Pipe

DROP-IN

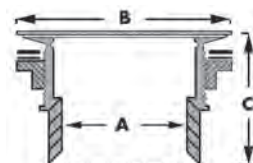

- Drain body drops through shower base
- Locknut tightens from underside
- Snap-in strainer

A	B	C
2"	4-1/4"	2-5/8"

PART NO.	DESCRIPTION	MATERIAL	CTN QTY
D41007	2" Solvent outlet with SS strainer	PVC	20
D41307	2" Solvent outlet with SS strainer	ABS	20
D41009	2" Solvent outlet with PB strainer	PVC	20
D41105	2" Solvent outlet with PB strainer	ABS	20
D41008	2" No-caulk/solvent outlet w/SS str.	PVC	20

Snap-in Replacement Strainers

PART NO.	DESCRIPTION	CTN QTY
D40005	SS for solvent outlet drains	10
D41103	SS for no caulk/solvent drains	10
D41104	Snap-in for D41008	10
D40010	SN	10
D40003	PB	10

General Purpose Drains with Long Body

2" x 3" Fits Over 2" or Inside 3" Schedule 40 DWV Pipe

MADE IN THE USA



PART NO.	A	B
D54-001L	4-1/4"	2"
D54-002L	4-1/4"	2-1/8"
D54-013L	4-1/4"	2-1/8"
D54-014L	4-1/2"	2-1/4"

PART NO.	DESCRIPTION	CTN QTY
D54001L	with SS strainer	20
D54002L	with CP Brass strainer	20
D54013L	with NB strainer	20
D54014L	with NB strainer with ring	20

General Purpose Drains

2" x 3" Fits Over 2" or Inside 3" Schedule 40 DWV Pipe
 3" x 4" Fits Over 3" or Inside 4" Schedule 40 DWV Pipe
 4" Fits Over 4" Schedule 40 Plastic Pipe

MADE IN THE USA

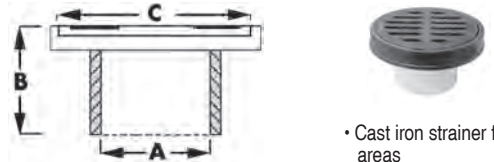

• Cast iron strainer for heavy trucking traffic areas

SIZE	A	B	C
2" x 3"	3"	5-1/16"	2-3/4"
3" x 4"	4"	5-1/16"	3-1/8"

PART NO.	DESCRIPTION	MATERIAL	CTN QTY
D54016	2" x 3" with CI ring and strainer	PVC	1
D54316	2" x 3" with CI ring and strainer	ABS	1
D54126	3" x 4" with CI ring and strainer	PVC	1
D54326	3" x 4" with CI ring and strainer	ABS	1
D54136	4" with CI ring and strainer	PVC	1
D54336	4" with CI ring and strainer	ABS	1

General Purpose Drains

3" x 4" Fits Over 3" or Inside 4" DWV Pipe

MADE IN THE USA

COVERALL TOPS

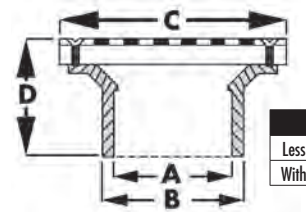

• Brass inserts

A	B	C	D
Less rings: 3" socket	Inside 4" pipe	5-3/16"	2-3/8"
With rings: 3" socket	Inside 4" pipe	5-1/2"	2-11/16"

PART NO.	DESCRIPTION	MATERIAL	CTN QTY
D54100	with SS strainer	PVC	10
D54400	with SS strainer	ABS	10
D54113	with NB strainer	PVC	10
D54323	with NB strainer	ABS	10
D54114	with NB strainer with ring	PVC	10
D54324	with NB strainer with ring	ABS	10
D54101	with CP strainer	PVC	10
D54401	with CP strainer	ABS	10
D54107	with CP strainer with ring	PVC	10
D54307	with CP strainer with ring	ABS	10
D54111	with PB strainer	PVC	10
D54321	with PB strainer	ABS	10
D54112	with PB strainer with ring	PVC	10
D54322	with PB strainer with ring	ABS	10

General Purpose Drains

4" Fits Over 4" Schedule 40 DWB Pipe

MADE IN THE USA

COVERALL TOPS

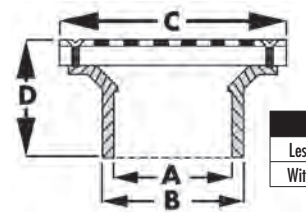

• Brass Inserts

A	B	C	D
Less rings: Over 4" pipe	5"	6-3/16"	2-5/8"
With rings: Over 4" pipe	5"	6-7/16"	2-3/4"

PART NO.	DESCRIPTION	MATERIAL	CTN QTY
D54104	with SS strainer	PVC	10
D54304	with SS strainer	ABS	10
D54130	with NB strainer	PVC	10
D54330	with NB strainer	ABS	10
D54132	with NB strainer with ring	PVC	10
D54332	with NB strainer with ring	ABS	10
D54102	with CP strainer	PVC	10
D54305	with CP strainer	ABS	10
D54137	with CP strainer with ring	PVC	10
D54337	with CP strainer with ring	ABS	10
D54105	with PB strainer	PVC	10
D54306	with PB strainer	ABS	10
D54131	with PB strainer with ring	PVC	10
D54331	with PB strainer with ring	ABS	10
D54133	with 7" PB square strainer	PVC	5
D54333	with 7" PB square strainer	ABS	5
D54134	with 7" NB square strainer	PVC	5
D54334	with 7" NB square strainer	ABS	5

Heavy Duty Traffic Floor Drains

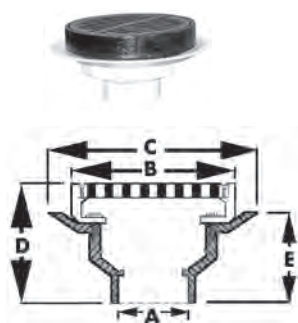

- Floor sink, area drain, garbage drain, yard drain
- 8-1/2" diameter grate
- Brass inserts
- Available with cast iron or plastic grate and ring

MADE IN THE
USA



	A	B	C	D	E
Over 2" pipe	9"	11"	4-11/16"	3-5/16"	
Over 3" pipe	9"	11"	4-11/16"	3-5/16"	
Over 4" pipe	9"	11"	5-1/16"	3-5/16"	

Full Cast Iron Grate and Ring

PART NO.	DESCRIPTION	MATERIAL	CTN	QTY
D50092	2" drain	PVC	1	
D50392	2" drain	ABS	1	
D50093	3" drain	PVC	1	
D50393	3" drain	ABS	1	
D50094	4" drain	PVC	1	
D50394	4" drain	ABS	1	
D50089	2" drain with CI sediment bucket	PVC	1	
D50389	2" drain with CI sediment bucket	ABS	1	
D50090	3" drain with CI sediment bucket	PVC	1	
D50390	3" drain with CI sediment bucket	ABS	1	
D50091	4" drain with CI sediment bucket	PVC	1	
D50391	4" drain with CI sediment bucket	ABS	1	

Full Plastic Grate and Ring

PART NO.	DESCRIPTION	MATERIAL	CTN	QTY
D50177	2" drain	PVC	1	
D50377	2" drain	ABS	1	
D50179	3" drain	PVC	1	
D50379	3" drain	ABS	1	
D50181	4" drain	PVC	1	
D50381	4" drain	ABS	1	
D50178	2" drain with debris bucket	PVC	1	
D50378	2" drain with debris bucket	ABS	1	
D50180	3" drain with debris bucket	PVC	1	
D50380	3" drain with debris bucket	ABS	1	
D50182	4" drain with debris bucket	PVC	1	
D50382	4" drain with debris bucket	ABS	1	
D50682	6" drain with debris bucket	PVC	1	
D50683	6" drain with debris bucket	ABS	1	

Three-Quarter Plastic Grate and Ring

PART NO.	DESCRIPTION	MATERIAL	CTN	QTY
D50183	2" drain	PVC	1	
D50383	2" drain	ABS	1	
D50184	3" drain	PVC	1	
D50384	3" drain	ABS	1	
D50185	4" drain	PVC	1	
D50385	4" drain	ABS	1	

Half Plastic Grate and Ring

PART NO.	DESCRIPTION	MATERIAL	CTN	QTY
D50186	2" drain	PVC	1	
D50386	2" drain	ABS	1	
D50187	3" drain	PVC	1	
D50387	3" drain	ABS	1	
D50188	4" drain	PVC	1	
D50388	4" drain	ABS	1	

Heavy Duty Traffic Floor Drains Replacement Parts

PART NO.	DESCRIPTION	MATERIAL	CTN	QTY
D50904	Full plastic grate	PVC	1	
D50905	Full plastic grate	ABS	1	
D50906	Three-quarter plastic grate	PVC	1	
D50907	Three-quarter plastic grate	ABS	1	
D50908	Half plastic grate	PVC	1	
D50909	Half plastic grate	ABS	1	
D50910	Plastic sediment / debris bucket	PVC	1	
D50911	Plastic sediment / debris bucket	ABS	1	
D50095	CI sediment / debris bucket		1	

8-1/2" Heavy Duty Traffic Floor Drain



- Floor sink, area drain, garbage drain, yard drain
- Full plastic 7-1/4" grate; 8-1/2" body
- Sediment bucket option
- 3 sizes available

MADE IN THE
USA

PART NO.	DESCRIPTION	MATERIAL	CTN	QTY
D49820	2" x 3"	PVC	1	
D49823	2" x 3"	ABS	1	
D49821	3" x 4"	PVC	1	
D49824	3" x 4"	ABS	1	
D49822	4"	PVC	1	
D49825	4"	ABS	1	

With Sediment Bucket

PART NO.	DESCRIPTION	MATERIAL	CTN	QTY
D49826	2" x 3"	PVC	1	
D49829	2" x 3"	ABS	1	
D49827	3" x 4"	PVC	1	
D49830	3" x 4"	ABS	1	
D49828	4"	PVC	1	
D49831	4"	ABS	1	
D49924	Sediment bucket		1	

All Plastic Snap-in Drains

Fits Into Schedule 40 DWV Pipe



MADE IN THE
USA

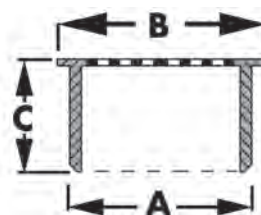

	A	B	C
Inside 2"		2-3/8"	1"
Inside 3"		3-1/2"	1-3/4"
Inside 4"		4-1/2"	2"

PART NO.	DESCRIPTION	MATERIAL	CTN	QTY
D42002	2"	PVC	20	
D42022	2"	ABS	20	
D42003	3"	PVC	20	
D42023	3"	ABS	20	
D42004	4"	PVC	20	
D42024	4"	ABS	20	

Snap-in Drains w/Stainless Steel Strainers

Fits Into Schedule 40 DWV Pipe

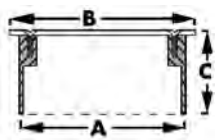

MADE IN THE USA

A	B	C
Inside 3" pipe	3-1/2"	2"
Inside 4" pipe	4-1/2"	2"

PART NO.	DESCRIPTION	MATERIAL	CTN QTY
D54003	3"	PVC	20
D54005	3"	ABS	20
D54004	4"	PVC	20
D54006	4"	ABS	20

Snap-in Strainers

Fits Inside Pipe



• Stainless steel

PART NO.	DESCRIPTION	CTN QTY
D59001	3-1/8" strainer fits inside 2" pipe	12
D59002	4-1/8" strainer fits inside 3" pipe	12
D59003	5-1/8" strainer fits inside 4" pipe	12

Socket Ring

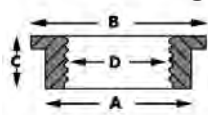

MADE IN THE USA

• Solvent welds into Schedule 40 hub to make threaded connection

A	B	C	D
2"	2-3/4"	1/2"	2" FIP
3"	4-1/16"	5/8"	3" FIP
4"	5-1/16"	5/8"	4" FIP

PART NO.	DESCRIPTION	MATERIAL	CTN QTY
P48002	2"	PVC	20
P48102	2"	ABS	20
P48003	3"	PVC	20
P48103	3"	ABS	20
P48004	4"	PVC	20
P48104	4"	ABS	20

Utility Drains

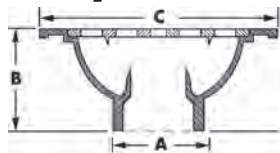

MADE IN THE USA

• Snap-in lid
• Use 2" coupling to connect 6" x 6" to 2" pipe

A	B	C	D
1-1/2" x 2"	2-3/8"	6"	4-9/16"
3" x 4"	3-7/16"	9"	7-11/16"
4"	4-9/16"	9"	7-11/16"
4" w/out stop	4-9/16"	9"	7-11/16"

PART NO.	DESCRIPTION	MATERIAL	CTN QTY
D40020	6" x 6" w/pipe stop; 1-1/2" hub; 2" spigot	PVC	20
D40021	9" x 9" w/pipe stop; 3" hub; 4" spigot	PVC	10
D40023	9" x 9" w/pipe stop; 4" hub	PVC	10
D42019	9" x 9" with 4" hub	PVC	10
D42029	9" x 9" with 4" hub	ABS	10

Bell Traps

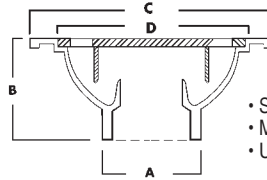

MADE IN THE USA

• Snap-in lid
• Molded bell in lid
• Use 2" coupling to convert 6" x 6" x 1-1/2" to 2" outlet

A	B	C	D
1-1/2" x 2"	2-3/8"	6"	4-9/16"
3" x 4"	4"	9"	7-3/4"
4"	4-1/2"	9"	7-3/4"

PART NO.	DESCRIPTION	MATERIAL	CTN QTY
D42006	6" x 6" with 1-1/2" x 2" outlet	PVC	20
D42011	6" x 6" with 1-1/2" x 2" outlet	ABS	20
D42009	9" x 9" with 3" x 4" outlet	PVC	10
D42012	9" x 9" with 3" x 4" outlet	ABS	10
D42010	9" x 9" with 4" hub fit outlet	PVC	10
D42013	9" x 9" with 4" hub fit outlet	ABS	10

Accessories

PART NO.	DESCRIPTION	CTN QTY
D42007	Lid for the D42006	1
D42008	Lid for the D42009 and D42010	1
D42014	Lid for the D42011	1
D42015	Lid for the D42012 and D42013	1

Heavy Duty PVC Bell Traps w/Hinged Lids

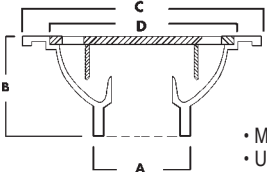

MADE IN THE USA

• Molded bell in lid
• Use 2" coupling to convert 6" x 6" x 1-1/2" to 2" outlet

A	B	C	D
1-1/2" x 2"	2-1/2"	6"	4-1/2"
3" x 4"	4-3/8"	9"	7-3/4"
4"	4-1/2"	9"	7-3/4"

PART NO.	DESCRIPTION	MATERIAL	CTN QTY
D42006H	6" x 6" with 1-1/2" x 2" outlet	PVC	20
D42009H	9" x 9" with 3" x 4" outlet	PVC	10
D42010H	9" x 9" with 4" outlet	PVC	10

Accessories

PART NO.	DESCRIPTION	CTN QTY
D42007H	Lid for the D42006H	1
D42008H	Lid for the D42009H and D42010H	1

4-Way Area Drain

Fits 2" or 3" Pipe

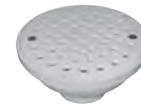
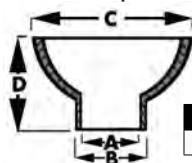

MADE IN THE USA

• Use with or without a p-trap

A	B	C	D
Over 2" pipe	Inside 3" pipe	7-1/4"	3-3/4"

PART NO.	DESCRIPTION	MATERIAL	CTN QTY
D50201	2" X 3"	PVC	15
D50601	2" X 3"	ABS	15
D50220	2" X 3" without stop	PVC	15
D50221	2" X 3" without stop	ABS	15
B06010	Replacement strainer	PVC	1
B06100	Replacement strainer	ABS	1

Area Drains

2" x 3" Fits Over 2" or Inside 3" Schedule 40 DWV Pipe
 3" x 4" Fits Over 3" or Inside 4" Schedule 40 DWV Pipe

MADE IN THE
USA

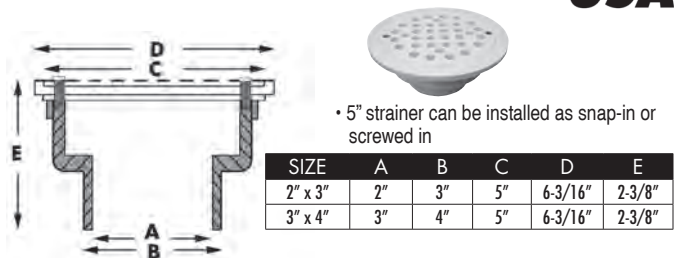

PART NO.	DESCRIPTION	MATERIAL	CTN	QTY
D40600	2" x 3"	PVC	12	
D40700	2" x 3"	ABS	12	
D40601	3" x 4"	PVC	12	
D40701	3" x 4"	ABS	12	
D40602	PVC Replacement Strainer	PVC	1	
D40702	ABS Replacement Strainer	ABS	1	

Floor Drains with Traps

2" Solvent Weld Outlet

MADE IN THE
USA

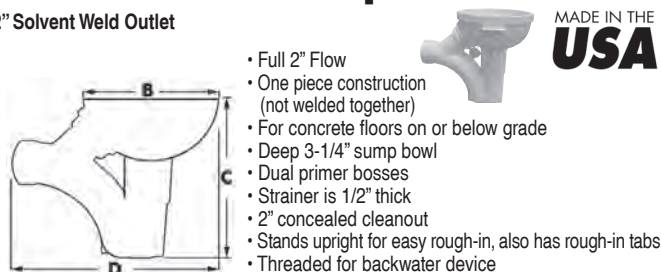

PIPE SIZE	B	C	D
2" IPS	7-5/8"	10-7/8"	11-3/4"

PART NO.	DESCRIPTION	MATERIAL	CTN	QTY
D50200	with full plastic grate	PVC	12	
D50600	with full plastic grate	ABS	12	
D50208	with 7-1/2" NB strainer	PVC	12	

Accessories

PART NO.	DESCRIPTION	MATERIAL	CTN	QTY
D50202	Full grate strainer	PVC	1	
D50205	Full grate strainer	ABS	1	
D50203	Three-quarter grate strainer	PVC	1	
D50206	Three-quarter grate strainer	ABS	1	
D50204	Half grate strainer	PVC	1	
D50207	Half grate strainer	ABS	1	
D50213	NB strainer		1	
B06001	Plastic backwater device		1	
B70499	Replacement ball		1	

Backwater Valves

MADE IN THE
USA

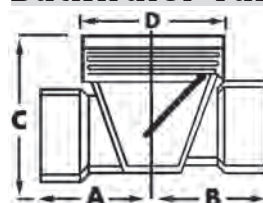

- Sockets are Schedule 40 DWV
- Reduces backflow in drainage system
- Threaded access cover for easy inspection
- Magnetic strip for underground detection
- Flapper and cover have elastomeric gasket to ensure watertight seal
- Stepped construction encourages flow (minimum 1/4" per foot fall)
- The 1-1/2", 2" and 6" have UPC, SBCCI and CSA listings.
- The 3" and 4" are NSF and UPC listed!

A	B	C	D
1/2"	2-3/16"	2"	4"
2"	2-7/16"	3-7/8"	4"
3"	3-7/8"	5-1/2"	6"
4"	5-3/8"	6-3/4"	8"
6"	7-3/4"	9-1/4"	10-3/4"

PART NO.	DESCRIPTION	MATERIAL	CTN	QTY
B04150	1-1/2"	PVC	12	
B05150	1-1/2"	ABS	12	
B04200	2"	PVC	12	
B05200	2"	ABS	12	
B04300	3"	PVC	2	
B05300	3"	ABS	2	
B04400	4"	PVC	1	
B05400	4"	ABS	1	
B04600	6"	PVC	1	
B05600	6"	ABS	1	
B04150K	1-1/2" with extension kit & CI lid	PVC	1	
B05150K	1-1/2" with extension kit & CI lid	ABS	1	
B04200K	2" with extension kit & CI lid	PVC	1	
B05200K	2" with extension kit & CI lid	ABS	1	
B04300K	3" with extension kit & CI lid	PVC	1	
B05300K	3" with extension kit & CI lid	ABS	1	
B04400K	4" with extension kit & CI lid	PVC	1	
B05400K	4" with extension kit & CI lid	ABS	1	
B04151K	1-1/2" with extension kit & plastic lid	PVC	1	
B04201K	2" with extension kit & plastic lid	PVC	1	
B04301K	3" with extension kit & plastic lid	PVC	1	

Flapper w/Gasket for Backwater Valve



PART NO.	DESCRIPTION	CTN	QTY
B04201	Fits 1-1/2" & 2" backwater valve		1
B04301	Fits 3" backwater valve		1
B04401	Fits 4" backwater valve		1

Extension Kit



• Kit includes cast iron top, 16" sleeve and adapter

PART NO.	DESCRIPTION	CTN QTY
B04303	3" complete kit w/CI lid	1
B04403	4" complete kit w/CI lid	1
B04304	3" complete kit w/plastic lid	1
B04404	4" complete kit w/plastic lid	1
BWV200	Ring adapter for 1-1/2" and 2"	1
BWV300	Ring adapter for 3"	1
BWV400	Ring adapter for 4"	1
B04006	6" CI lid for 3" (fits 6" pipe)	1
B04008	8" CI lid for 4" (fits 8" pipe)	1

Cast Iron Cover Marked for Water 6" PVC Pipe



• Covers 6" PVC and ABS pipe

PART NO.	DESCRIPTION	CTN QTY
B04007	For 6" Plastic Pipe	1

Condensate Traps

Manufactured of Schedule 40 DWV Pipe



• One-piece design

PART NO.	DESCRIPTION	CTN QTY
P15050	1/2" p-trap	100
P15075	3/4" p-trap	100
P15175	3/4" mini p-trap	250
R15050	1/2" running trap	100
R15075	3/4" running trap	100

Mushroom Vent Caps

Fits 3" or 4" Vent Stacks



• Gray PVC construction
• Includes three installation screws

MADE IN THE
USA

PART NO.	DESCRIPTION	CTN QTY
M05034	3" x 4"	20

Flat Top Vent Cap



• White PVC construction
• Fits 3" and 4" vent stacks
• Includes 2 set screws for securing cap

MADE IN THE
USA

PART NO.	DESCRIPTION	CTN QTY
M05134	Flat top vent cap	20

PVC Couplings

4" x 4" Connects 4" Schedule 40 DWV Pipe to 4" SDR



MADE IN THE
USA

PART NO.	DESCRIPTION	CTN QTY
C67440	4" DWV to 4" SDR	10

PVC Multi-Use Couplings



• Use to reduce or increase variety of sizes of Schedule 40 pipe

MADE IN THE
USA

PART NO.	DESCRIPTION	CTN QTY
C67230	2" x 3"	1
C67340	3" x 4"	1

Spigot Adapter



• 4" DWV x 4" SDR spigot

MADE IN THE
USA

PART NO.	DESCRIPTION	CTN QTY
C67445	4" DWV x 4" SDR spigot	1

Plastic Over-Fitting Repair Fitting



• More efficient and less costly way to handle many common PVC re-piping problems
• Available in 1-1/2", 2", 3" and 4" PVC
• Compatible with all fittings
• Raised lettering on hub actually helps seal chemical bond
• Glues over the hub of a fitting on one end and is a 1-1/2" or 2" hub on the other end

MADE IN THE
USA

PART NO.	DESCRIPTION	MATERIAL	CTN QTY
P22100	1-1/2"	PVC	1
P22101	1-1/2"	ABS	1
P22200	2"	PVC	1
P22201	2"	ABS	1
P22300	3"	PVC	1
P22400	4"	PVC	1

Pipe Fit Base



MADE IN THE
USA



PART NO.	PIPE SIZE	SCH 40 DWV PIPE	SPUD SIZE	MATERIAL	CTN QTY
D52120	2"	over 2" w/PT	2"	PVC	20
D52012	2"	over 2" and inside 3"	2"	PVC	20
D52112	2"	over 2" and inside 3"	2"	ABS	20
D52013	3"	over 3"	3"	PVC	10
D52016	3"	over 3"	3"	ABS	10
D52450	3" x 4"	over 3" and inside 4" w/PT	3"	PVC	10
D52460	3" x 4"	over 3" and inside 4" w/PT	3"	ABS	10
D52400	3" x 4"	over 3" and inside 4"	3-1/2"	PVC	10
D52500	3" x 4"	over 3" and inside 4"	3-1/2"	ABS	10
D52451	3" x 4"	over 3" and inside 4" w/PT	3-1/2"	PVC	10
D52461	3" x 4"	over 3" and inside 4" w/PT	3-1/2"	ABS	10
D52005	4"	over 4"	3-1/2"	PVC	10
D52105	4"	over 4"	3-1/2"	ABS	10
D52452	4"	over 4" w/PT	3-1/2"	PVC	10
D52462	4"	over 4" w/PT	3-1/2"	ABS	10
D52014	4"	over 4"	4"	PVC	10
D52017	4"	over 4"	4"	ABS	10
D52453	4"	over 4" w/PT	4"	PVC	10
D52463	4"	over 4" w/PT	4"	ABS	10

Inside Pipe Fit Base



MADE IN THE
USA



PART NO.	PIPE SIZE	SCH 40 DWV PIPE	SPUD SIZE	MATERIAL	CTN QTY
D52023	3"	inside 3"	2"	PVC	1
D52123	3"	inside 3"	2"	ABS	1
D52004	4"	inside 4"	3"	PVC	1
D52104	4"	inside 4"	3"	ABS	1

Hub Fit Bases



MADE IN THE
USA



PART NO.	PIPE SIZE	SCH 40 DWV PIPE	SPUD SIZE	MATERIAL	CTN QTY
D52003	4"	inside 4" hub	3-1/2"	PVC	10
D52103	4"	inside 4" hub	3-1/2"	ABS	10

Heavy Duty Bases with Clamping Ring

MADE IN THE
USA



- Completely adjustable; reversible clamping ring gains additional 1" height
- 8-1/2" Pan
- Gray PVC / Black ABS
- Extra weep holes
- Primer tapped with 1/2" plug

PART NO.	PIPE SIZE	SCH 40 DWV PIPE	SPUD SIZE	MATERIAL	CTN QTY
D49800	2" x 3"	over 2" and inside 3"	3"	PVC	1
D49810	2" x 3"	over 2" and inside 3"	3"	ABS	1
D49801	2" x 3"	over 2" and inside 3"	3-1/2"	PVC	1
D49811	2" x 3"	over 2" and inside 3"	3-1/2"	ABS	1
D49802	2" x 3"	over 2" and inside 3"	4"	PVC	1
D49812	2" x 3"	over 2" and inside 3"	4"	ABS	1
D49803	3" x 4"	over 3" and inside 4"	3"	PVC	1
D49813	3" x 4"	over 3" and inside 4"	3"	ABS	1
D49804	3" x 4"	over 3" and inside 4"	3-1/2"	PVC	1
D49814	3" x 4"	over 3" and inside 4"	3-1/2"	ABS	1
D49805	3" x 4"	over 3" and inside 4"	4"	PVC	1
D49815	3" x 4"	over 3" and inside 4"	4"	ABS	1
D49806	4"	over 4"	3"	PVC	1
D49816	4"	over 4"	3"	ABS	1
D49807	4"	over 4"	3-1/2"	PVC	1
D49817	4"	over 4"	3-1/2"	ABS	1
D49808	4"	over 4"	4"	PVC	1
D49818	4"	over 4"	4"	ABS	1

Slab Drain Bases

MADE IN THE
USA



- 8-1/2" Pan for applications where no clamping ring is required
- Spud threads directly into base
- Primer tapped with 1/2" plug
- Gray PVC / Black ABS
- Completely adjustable

PART NO.	PIPE SIZE	SCH 40 DWV PIPE	SPUD SIZE	MATERIAL	CTN QTY
D49850	2" x 3"	over 2" and inside 3"	3"	PVC	1
D49860	2" x 3"	over 2" and inside 3"	3"	ABS	1
D49851	2" x 3"	over 2" and inside 3"	3-1/2"	PVC	1
D49861	2" x 3"	over 2" and inside 3"	3-1/2"	ABS	1
D49852	2" x 3"	over 2" and inside 3"	4"	PVC	1
D49862	2" x 3"	over 2" and inside 3"	4"	ABS	1
D49853	3" x 4"	over 3" and inside 4"	3"	PVC	1
D49863	3" x 4"	over 3" and inside 4"	3"	ABS	1
D49854	3" x 4"	over 3" and inside 4"	3-1/2"	PVC	1
D49864	3" x 4"	over 3" and inside 4"	3-1/2"	ABS	1
D49855	3" x 4"	over 3" and inside 4"	4"	PVC	1
D49865	3" x 4"	over 3" and inside 4"	4"	ABS	1
D49856	4"	over 4"	3"	PVC	1
D49866	4"	over 4"	3"	ABS	1
D49857	4"	over 4"	3-1/2"	PVC	1
D49867	4"	over 4"	3-1/2"	ABS	1
D49858	4"	over 4"	4"	PVC	1
D49868	4"	over 4"	4"	ABS	1

Heavy Duty Bases



- 10" Pan
- Primer tapped, includes 1/2" plug
- Adjustable

MADE IN THE
USA



PART NO.	PIPE SIZE	SCH 40 DWV PIPE	SPUD SIZE	MATERIAL	CTN QTY
D52202	2"	over 2"	3-1/2"	PVC	1
D52302	2"	over 2"	3-1/2"	ABS	1
D52205	2"	over 2"	4"	PVC	1
D52305	2"	over 2"	4"	ABS	1
D52203	3"	over 3"	3-1/2"	PVC	1
D52303	3"	over 3"	3-1/2"	ABS	1
D52206	3"	over 3"	4"	PVC	1
D52306	3"	over 3"	4"	ABS	1
D52204	4"	over 4"	3-1/2"	PVC	1
D52304	4"	over 4"	3-1/2"	ABS	1
D52207	4"	over 4"	4"	PVC	1
D52307	4"	over 4"	4"	ABS	1
D52216	6"	over 6"	3-1/2"	PVC	1
D52316	6"	over 6"	3-1/2"	ABS	1
D52217	6"	over 6"	4"	PVC	1
D52317	6"	over 6"	4"	ABS	1

Round Strainers w/2" Plastic Spuds



PART NO.	IPS	STRAINER	MATERIAL	CTN QTY
D50980	2"	4" SS	PVC	1
D57980	2"	4" SS	ABS	1
D50987	2"	4" CP	PVC	1
D57987	2"	4" CP	ABS	1
D50988	2"	4" CP with ring	PVC	1
D57988	2"	4" CP with ring	ABS	1
D50985	2"	4" NB	PVC	1
D57985	2"	4" NB	ABS	1
D50986	2"	4" NB with ring	PVC	1
D57986	2"	4" NB with ring	ABS	1
D50983	2"	4" PB cast	PVC	1
D57983	2"	4" PB cast	ABS	1
D50984	2"	4" PB with ring	PVC	1
D57984	2"	4" PB with ring	ABS	1
D50982	2"	4" PB stamped	PVC	1
D57982	2"	4" PB stamped	ABS	1

Round Strainers w/3" Plastic Spuds



PART NO.	IPS	STRAINER	MATERIAL	CTN QTY
D56105	3"	6" SS	PVC	1
D57105	3"	6" SS	ABS	1
D56205	3"	6" CP	PVC	1
D57205	3"	6" CP	ABS	1
D56210	3"	6" CP with ring	PVC	1
D57210	3"	6" CP with ring	ABS	1
D56405	3"	6" NB	PVC	1
D57405	3"	6" NB	ABS	1
D56404	3"	6" NB with ring	PVC	1
D57404	3"	6" NB with ring	ABS	1
D56305	3"	6" PB	PVC	1
D57305	3"	6" PB	ABS	1
D56304	3"	6" PB with ring	PVC	1
D57304	3"	6" PB with ring	ABS	1

Round Strainers w/3-1/2" Plastic Spuds



PART NO.	IPS	STRAINER	MATERIAL	CTN QTY
D56211	3-1/2"	5" SS	PVC	1
D57211	3-1/2"	5" SS	ABS	1
D56216	3-1/2"	5" CP	PVC	1
D57216	3-1/2"	5" CP	ABS	1
D56217	3-1/2"	5" CP with ring	PVC	1
D57217	3-1/2"	5" CP with ring	ABS	1
D56214	3-1/2"	5" NB	PVC	1
D57214	3-1/2"	5" NB	ABS	1
D56215	3-1/2"	5" NB with ring	PVC	1
D57215	3-1/2"	5" NB with ring	ABS	1
D56212	3-1/2"	5" PB	PVC	1
D57212	3-1/2"	5" PB	ABS	1
D56213	3-1/2"	5" PB with ring	PVC	1
D57213	3-1/2"	5" PB with ring	ABS	1
D56106	3-1/2"	6" SS	PVC	1
D57106	3-1/2"	6" SS	ABS	1
D56206	3-1/2"	6" CP	PVC	1
D57206	3-1/2"	6" CP	ABS	1
D56209	3-1/2"	6" CP with ring	PVC	1
D57209	3-1/2"	6" CP with ring	ABS	1
D56406	3-1/2"	6" NB	PVC	1
D57406	3-1/2"	6" NB	ABS	1
D56407	3-1/2"	6" NB with ring	PVC	1
D57407	3-1/2"	6" NB with ring	ABS	1
D56306	3-1/2"	6" PB	PVC	1
D57306	3-1/2"	6" PB	ABS	1
D56307	3-1/2"	6" PB with ring	PVC	1
D57307	3-1/2"	6" PB with ring	ABS	1

Round Strainers w/4" Plastic Spuds



PART NO.	IPS	STRAINER	MATERIAL	CTN QTY
D56107	4"	6" SS	PVC	1
D57107	4"	6" SS	ABS	1
D56207	4"	6" CP	PVC	1
D57207	4"	6" CP	ABS	1
D56208	4"	6" CP with ring	PVC	1
D57208	4"	6" CP with ring	ABS	1
D56408	4"	6" NB	PVC	1
D57408	4"	6" NB	ABS	1
D56409	4"	6" NB with ring	PVC	1
D57409	4"	6" NB with ring	ABS	1
D56308	4"	6" PB	PVC	1
D57308	4"	6" PB	ABS	1
D56309	4"	6" PB with ring	PVC	1
D57309	4"	6" PB with ring	ABS	1

Round Strainers w/2" Metal Spuds



PART NO.	IPS	STRAINER	CTN QTY
D60980	2"	4" SS	1
D60981	2"	4" CP	1
D60982	2"	4" PB	1
D60970	2"	6" CP	1
D60975	2"	6" PB	1

Round Strainers w/3" Metal Spuds



PART NO.	IPS	STRAINER	CTN QTY
D60955	3"	5" NB	1
D60956	3"	5" PB	1
D60945	3"	8" NB	1

Round Strainers w/3-1/2" Metal Spuds



PART NO.	IPS	STRAINER	CTN QTY
D60986	3-1/2"	4" NB	1
D60987	3-1/2"	4" PB	1
D60990	3-1/2"	5" CP	1
D60996	3-1/2"	5" NB	1
D60991	3-1/2"	5" PB	1
D60992	3-1/2"	6" CP	1
D60997	3-1/2"	6" NB	1
D60993	3-1/2"	6" PB	1
D60994	3-1/2"	8" CP	1
D60998	3-1/2"	8" NB	1
D60995	3-1/2"	8" PB	1
D60999	3-1/2"	9" NB	1
D60989	3-1/2"	9" PB	1

Round Strainers w/4" Metal Spuds



PART NO.	IPS	STRAINER	CTN QTY
D60958	4"	5" NB	1
D60959	4"	5" PB	1
D60940	4"	9" NB	1

Replacement Strainers for Metal Spuds



PART NO.	DESCRIPTION	MATERIAL	CTN QTY
D60780	Fits D60-980	SS	1
D60781	Fits D60-981	CP	1
D60782	Fits D60-982	PB	1
D60790	Fits D60-990	CP	1
D60791	Fits D60-991	PB	1
D60792	Fits D60-992	CP	1
D60793	Fits D60-993	PB	1
D60794	Fits D60-994	CP	1
D60795	Fits D60-995	PB	1
D60966	Fits D60-986	NB	1
D60967	Fits D60-987	PB	1
D60968	Fits D60-996	NB	1
D60969	Fits D60-997	NB	1

Square Strainers w/2" Plastic Spuds



MADE IN THE USA



PART NO.	IPS	STRAINER	MATERIAL	CTN QTY
D50989	2"	4" CP	PVC	1
D57989	2"	4" CP	ABS	1
D50990	2"	4" PB	PVC	1
D57990	2"	4" PB	ABS	1

7" Square Strainers w/3" Plastic Spuds



MADE IN THE USA



PART NO.	IPS	STRAINER	MATERIAL	CTN QTY
D56501	3"	5" NB	PVC	1
D57501	3"	5" NB	ABS	1
D56500	3"	5" PB	PVC	1
D57500	3"	5" PB	ABS	1

7" Square Strainers w/3-1/2" Plastic Spuds



MADE IN THE USA



PART NO.	IPS	STRAINER	MATERIAL	CTN QTY
D56503	3-1/2"	5" NB	PVC	1
D57503	3-1/2"	5" NB	ABS	1
D56502	3-1/2"	5" PB	PVC	1
D57502	3-1/2"	5" PB	ABS	1

7" Square Strainers w/4" Plastic Spuds



PART NO.	IPS	STRAINER	MATERIAL	CTN QTY
D56505	4"	5" NB	PVC	1
D57505	4"	5" NB	ABS	1
D56504	4"	5" PB	PVC	1
D57504	4"	5" PB	ABS	1

Square Strainers w/3-1/2" Metal Spuds



PART NO.	IPS	STRAINER	CTN QTY
D60954	3-1/2"	5" CP	1
D60962	3-1/2"	5" NB	1
D60960	3-1/2"	5" PB	1
D60963	3-1/2"	6" NB	1
D60961	3-1/2"	6" PB	1

Strainers



- 4" Fits 4-1/4" diameter drain and cleanout spuds, D50 (2" x 3") series shower drains and 2" x 3" general purpose drains
- 5" Fits 5" diameter drain and cleanout spuds and 3" x 4" General Purpose Drains
- 6" Fits 6-1/8" diameter drain and cleanout spuds and 4" General Purpose Drains

PART NO.	SIZE	DESCRIPTION	CTN QTY
C60809	4"	SS coverall	1
D54008	4"	SS fits inside plastic ring	1
C60806	4"	CP cast coverall	1
C60812	4"	CP cast square coverall	1
C60808	4"	NB cast coverall	1
C60807	4"	PB cast coverall	1
C60813	4"	PB cast square coverall	1
C60810	4"	PB PVD finish coverall	1
C60814	4"	SN coverall	1
D54010	4"	PB fits inside plastic ring	1
C60811	5"	SS coverall	1
D54108	5"	SS fits inside plastic ring	1
C60803	5"	CP cast coverall	1
D54109	5"	CP cast fits inside plastic ring	1
C60805	5"	NB cast coverall	1
C60804	5"	PB cast coverall	1
D59100	6"	SS coverall	1
C60800	6"	CP cast coverall	1
C60802	6"	NB cast coverall	1
C60801	6"	PB cast coverall	1

Covers



- 4" Fits 4-1/4" diameter drain and cleanout spuds, D50 (2" x 3") series shower drains and 2" x 3" general purpose drains
- 5" Fits 5" diameter drain and cleanout spuds and 3" x 4" General Purpose Drains
- 6" Fits 6-1/8" diameter drain and cleanout spuds and 4" General Purpose Drains

PART NO.	SIZE	DESCRIPTION	CTN QTY
C60504	4"	NB cast cleanout cover	1
C60505	4"	PB cast cleanout cover	1
C60503	5"	NB cast cleanout cover	1
C60502	5"	PB cast cleanout cover	1
C60501	6"	NB cast coverall	1
C60500	6"	PB cast coverall	1

Rings



- 4" Fits 4-1/4" diameter drain and cleanout spuds, D50 (2" x 3") series shower drains and 2" x 3" general purpose drains
- 5" Fits 5" diameter drain and cleanout spuds and 3" x 4" General Purpose Drains
- 6" Fits 6-1/8" diameter drain and cleanout spuds and 4" General Purpose Drains

PART NO.	SIZE	DESCRIPTION	CTN QTY
C60818	4"	CP ring	1
C60825	4"	NB ring	1
C60824	4"	PB ring	1
C60819	5"	CP ring	1
C60823	5"	NB ring	1
C60822	5"	PB ring	1
C60817	6"	CP ring	1
C60821	6"	NB ring	1
C60820	6"	PB ring	1

Spud Extension



- 2-1/2" - 4" extension for a 3-1/2" drain / cleanout spud
- Use on cast iron or PVC drain bodies when additional height is needed to offset inconsistent concrete pours

PART NO.	SIZE	DESCRIPTION	CTN QTY
D60979	3-1/2"	Spud extension	1

Funnels



- Supplied with screws
- Vandal-proof installation
- Fits virtually any floor/shower drain
- Funnel tapped for 10-24 screws which are supplied with washers

PART NO.	SIZE	DESCRIPTION	CTN QTY
F65400	4"	Funnel	1
F65600	6"	Funnel	1

3" x 4" Pipe Fit Base with 3-1/2" Plastic Spuds

5" Round Strainers

Fits Over 3" or Inside 4" Schedule 40 DWV Pipe

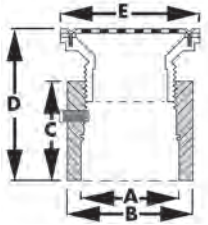

- SS strainers are .06" thick
- Polished Brass, Nickel Bronze and Chrome Plated strainers are 3/16" thick
- Strainers available in SS, PB, NB and CP
- Adjustable (see dimension D)
- Primer tapped, includes 1/2" plug

	A	B	C	D	E
Without ring	Over 3" pipe	Inside 4" pipe	4-1/2"	5-1/16" – 7-1/8"	5-3/16"
With ring	Over 3" pipe	Inside 4" pipe	4-1/2"	5-13/16" – 7-1/4"	5-1/2"

PART NO.	STRAINER	MATERIAL	CTN QTY
D53428	5" SS	PVC	1
D53435	5" SS	ABS	1
D53429	5" PB	PVC	1
D53436	5" PB	ABS	1
D53430	5" PB with ring	PVC	1
D53437	5" PB with ring	ABS	1
D53431	5" NB	PVC	1
D53438	5" NB	ABS	1
D53432	5" NB with ring	PVC	1
D53439	5" NB with ring	ABS	1
D53433	5" CP	PVC	1
D53440	5" CP	ABS	1
D53434	5" CP with ring	PVC	1
D53441	5" CP with ring	ABS	1

3" x 4" Pipe Fit Base with 3-1/2" Plastic Spuds

6" Round Strainer

Fits Over 3" or Inside 4" Schedule 40 DWV Pipe

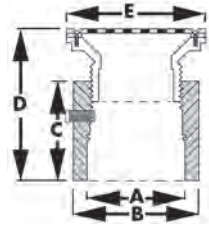

- SS strainers are .06" thick
- Polished Brass, Nickel Bronze and Chrome Plated strainers are 3/16" thick
- Strainers available in SS, PB, NB and CP
- Adjustable (see dimension D)
- Primer tapped, includes 1/2" plug

	A	B	C	D	E
Without ring	Over 3" pipe	Inside 4" pipe	4-1/2"	5-3/4" – 7-1/4"	6-1/8"
With ring	Over 3" pipe	Inside 4" pipe	4-1/2"	6-1/16" – 7-5/16"	6-1/2"

PART NO.	STRAINER	MATERIAL	CTN QTY
D53020	6" SS	PVC	1
D53023	6" SS	ABS	1
D53022	6" PB	PVC	1
D53025	6" PB	ABS	1
D53074	6" PB with ring	PVC	1
D53075	6" PB with ring	ABS	1
D53072	6" NB	PVC	1
D53073	6" NB	ABS	1
D53076	6" NB with ring	PVC	1
D53077	6" NB with ring	ABS	1
D53021	6" CP	PVC	1
D53024	6" CP	ABS	1
D53284	6" CP with ring	PVC	1
D53285	6" CP with ring	ABS	1

3" x 4" Pipe Fit Base with 3-1/2" Plastic Spuds

6" Square Tops and 5" Round Strainer

Fits Over 3" or Inside 4" Schedule 40 DWV Pipe

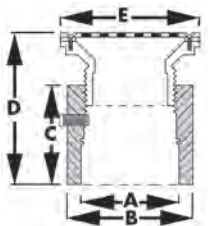

- Primer tapped, includes 1/2" plug
- Adjustable (see dimension D)

	A	B	C	D	E
Square top	Over 3" pipe	Inside 4" pipe	4-1/2"	5-3/4" – 7-1/8"	6"

PART NO.	STRAINER	MATERIAL	CTN QTY
D59900	5" NB	PVC	1

3" x 4" Pipe Fit Base with 3-1/2" Plastic Spuds

7" Square Tops and 5" Round Strainer

Fits Over 3" or Inside 4" Schedule 40 DWV Pipe

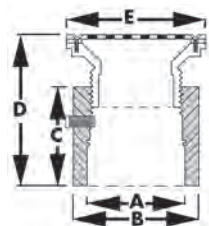

- Strainers are available in PB and NB
- Primer tapped, includes 1/2" plug
- Adjustable (see dimension D)

	A	B	C	D	E
Square top	Over 3" pipe	Inside 4" pipe	4-1/2"	5-15/16" – 7-3/8"	7"

PART NO.	STRAINER	MATERIAL	CTN QTY
D53246	5" PB	PVC	1
D53247	5" PB	ABS	1
D53248	5" NB	PVC	1
D53249	5" NB	ABS	1

3" x 4" Pipe Fit Base with 3-1/2" Metal Spuds

5", 6", 8" or 9" Round Strainer

Fits Over 3" or Inside 4" Schedule 40 DWV Pipe

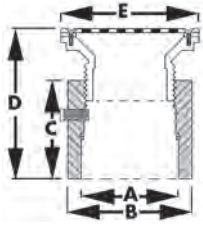

- Strainers are available in PB, NB and CP
- Primer tapped, includes 1/2" plug
- Adjustable (see dimension D)

	A	B	C	D	E
Metal spud	Over 3" pipe	Inside 4" pipe	4-1/2"	4-7/8" – 6-1/16"	5"
Metal spud	Over 3" pipe	Inside 4" pipe	4-1/2"	5-5/16" – 6-11/16"	6"
Metal spud	Over 3" pipe	Inside 4" pipe	4-1/2"	5-3/8" – 6-7/8"	8"
Metal spud	Over 3" pipe	Inside 4" pipe	4-1/2"	5-3/8" – 6-7/8"	9"

PART NO.	STRAINER	MATERIAL	CTN QTY
D53027	5" PB	PVC	1
D53033	5" PB	ABS	1
D53124	5" NB	PVC	1
D53126	5" NB	ABS	1
D53026	5" CP	PVC	1
D53032	5" CP	ABS	1
D53029	6" PB	PVC	1
D53035	6" PB	ABS	1
D53125	6" NB	PVC	1
D53127	6" NB	ABS	1
D53028	6" CP	PVC	1
D53034	6" CP	ABS	1
D53031	8" PB	PVC	1
D53037	8" PB	ABS	1
D53138	8" NB	PVC	1
D53139	8" NB	ABS	1
D53030	8" CP	PVC	1
D53036	8" CP	ABS	1
D53142	9" PB	PVC	1
D53143	9" PB	ABS	1
D53140	9" NB	PVC	1
D53141	9" NB	ABS	1

3" x 4" Pipe Fit Base with 3-1/2" Metal Spuds

5" or 6" Square Strainer

Fits Over 3" or Inside 4" Schedule 40 DWV Pipe

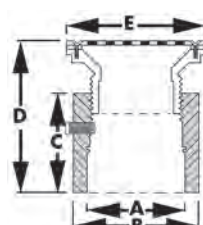

- Strainers are available in PB and NB
- Primer tapped, includes 1/2" plug
- Adjustable (see dimension D)

	A	B	C	D	E
Square top	Over 3" pipe	Inside 4" pipe	4-1/2"	5-3/4" – 7-1/8"	5" or 6"

PART NO.	STRAINER	MATERIAL	CTN QTY
D53078	5" PB	PVC	1
D53079	5" PB	ABS	1
D53082	5" NB	PVC	1
D53083	5" NB	ABS	1
D53080	6" PB	PVC	1
D53081	6" PB	ABS	1
D53084	6" NB	PVC	1
D53085	6" NB	ABS	1

4" Over Pipe Fit Base with 3-1/2" Plastic Spuds

5" Round Strainer

Fits Over 4" Schedule 40 DWV Pipe

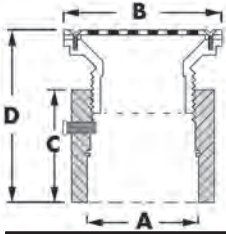

- Stainless steel strainers are .06" thick
- Strainers are available in SS, PB, NB and CP
- PB, NB and CP strainers are 3/16" thick
- Primer tapped, includes 1/2" plug
- Adjustable (see dimension D)

	A	B	C	D
Without ring	Over 4" pipe	5-3/16"	4-3/4"	6" - 7-3/8"
With ring	Over 4" pipe	5-1/2"	4-3/4"	6-1/8" - 7-1/2"

PART NO.	STRAINER	MATERIAL	CTN QTY
D53414	5" SS	PVC	1
D53421	5" SS	ABS	1
D53415	5" PB	PVC	1
D53422	5" PB	ABS	1
D53416	5" PB with ring	PVC	1
D53423	5" PB with ring	ABS	1
D53417	5" NB	PVC	1
D53424	5" NB	ABS	1
D53418	5" NB with ring	PVC	1
D53425	5" NB with ring	ABS	1
D53419	5" CP	PVC	1
D53426	5" CP	ABS	1
D53420	5" CP with ring	PVC	1
D53427	5" CP with ring	ABS	1

4" Over Pipe Fit Base with 3-1/2" Plastic Spuds

6" Round Strainer

Fits Over 4" Schedule 40 DWV Pipe

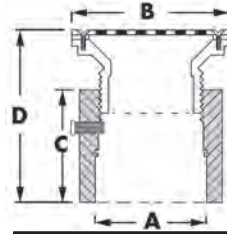

- Stainless steel strainers are .06" thick
- Strainers are available in SS, PB, NB and CP
- PB, NB and CP strainers are 3/16" thick
- Primer tapped, includes 1/2" plug
- Adjustable (see dimension D)

	A	B	C	D
Without ring	Over 4" pipe	6-1/8"	4-3/4"	6" - 7-1/2"
With ring	Over 4" pipe	6-1/2"	4-3/4"	6-1/4" - 7-5/8"

PART NO.	STRAINER	MATERIAL	CTN QTY
D53040	6" SS	PVC	1
D53043	6" SS	ABS	1
D53042	6" PB	PVC	1
D53045	6" PB	ABS	1
D53088	6" PB with ring	PVC	1
D53089	6" PB with ring	ABS	1
D53086	6" NB	PVC	1
D53087	6" NB	ABS	1
D53090	6" NB with ring	PVC	1
D53091	6" NB with ring	ABS	1
D53041	6" CP	PVC	1
D53044	6" CP	ABS	1
D53282	6" CP with ring	PVC	1
D53283	6" CP with ring	ABS	1

4" Over Pipe Fit Base with 3-1/2" Plastic Spuds

7" Square Top and 5" Round Strainer

Fits Over 4" Schedule 40 DWV Pipe

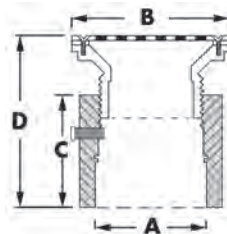

- Strainers are available in PB and NB
- Strainers are 3/16" thick
- Primer tapped, includes 1/2" plug
- Adjustable (see dimension D)

	A	B	C	D
Square	Over 4" pipe	7"	4-3/4"	5-1/2" - 6-7/8"

PART NO.	STRAINER	MATERIAL	CTN QTY
D53250	5" PB	PVC	1
D53251	5" PB	ABS	1
D53252	5" NB	PVC	1
D53253	5" NB	ABS	1

4" Over Pipe Fit Base with 3-1/2" Metal Spuds

5", 6", 8" or 9" Round Strainer

Fits Over 4" Schedule 40 DWV Pipe

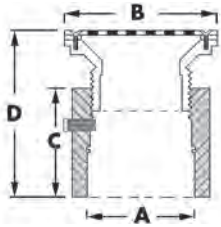

- Strainers are available in SS, PB, NB and CP
- PB, NB and CP strainers are 3/16" thick
- Primer tapped, includes 1/2" plug
- Adjustable (see dimension D)

	A	B	C	D
Round	Over 4" pipe	5-3/16"	4-3/4"	5-1/8" – 6-3/8"
Round	Over 4" pipe	6-3/16"	4-3/4"	5-5/16" – 6-5/8"
Round	Over 4" pipe	8"	4-3/4"	5-1/2" – 7"
Round	Over 4" pipe	9"	4-3/4"	5-1/2" – 7-1/8"

PART NO.	STRAINER	MATERIAL	CTN QTY
D53047	5" PB	PVC	1
D53053	5" PB	ABS	1
D53128	5" NB	PVC	1
D53130	5" NB	ABS	1
D53046	5" CP	PVC	1
D53052	5" CP	ABS	1
D53049	6" PB	PVC	1
D53055	6" PB	ABS	1
D53129	6" NB	PVC	1
D53131	6" NB	ABS	1
D53048	6" CP	PVC	1
D53054	6" CP	ABS	1
D53051	8" PB	PVC	1
D53057	8" PB	ABS	1
D53132	8" NB	PVC	1
D53133	8" NB	ABS	1
D53050	8" CP	PVC	1
D53056	8" CP	ABS	1
D53136	9" PB	PVC	1
D53137	9" PB	ABS	1
D53134	9" NB	PVC	1
D53135	9" NB	ABS	1

4" Over Pipe Fit Base with 3-1/2" Metal Spuds

5" or 6" Square Strainer

Fits Over 4" Schedule 40 DWV Pipe

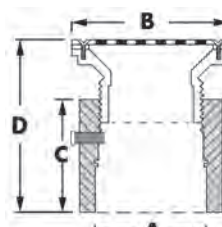

- Strainers are available in PB and NB
- Strainers are 3/16" thick
- Primer tapped, includes 1/2" plug
- Adjustable (see dimension D)

	A	B	C	D
Square	Over 4" pipe	5" or 6"	4-3/4"	5-5/16" – 6-5/8"

PART NO.	STRAINER	MATERIAL	CTN QTY
D53092	5" PB	PVC	1
D53093	5" PB	ABS	1
D53096	5" NB	PVC	1
D53097	5" NB	ABS	1
D53094	6" PB	PVC	1
D53095	6" PB	ABS	1
D53098	6" NB	PVC	1
D53099	6" NB	ABS	1

4" Over Pipe Fit Base with 4" Plastic Spuds

6" Round Strainer

Fits Over 4" Schedule 40 DWV Pipe



MADE IN THE USA

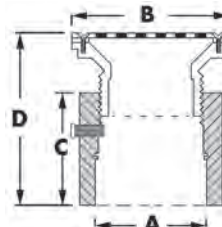

- Stainless steel strainers are .06" thick
- Strainers are available in SS, PB, NB and CP
- PB, NB and CP strainers are 3/16" thick
- Primer tapped, includes 1/2" plug
- Adjustable (see dimension D)

	A	B	C	D
Without ring	Over 4" pipe	6-1/8"	4-3/4"	6" – 7-3/16"
With ring	Over 4" pipe	6-1/2"	4-3/4"	6-1/8" – 7-5/16"

PART NO.	STRAINER	MATERIAL	CTN QTY
D53262	6" SS	PVC	4
D53272	6" SS	ABS	4
D53263	6" PB	PVC	4
D53273	6" PB	ABS	4
D53264	6" PB with ring	PVC	4
D53274	6" PB with ring	ABS	4
D53265	6" NB	PVC	4
D53275	6" NB	ABS	4
D53266	6" NB with ring	PVC	4
D53276	6" NB with ring	ABS	4
D53269	6" CP	PVC	4
D53279	6" CP	ABS	4
D53286	6" CP with ring	PVC	4
D53287	6" CP with ring	ABS	4

4" Over Pipe Fit Base with 4" Plastic Spuds

7" Square Top and 5" Round Strainer

Fits Over 4" Schedule 40 DWV Pipe

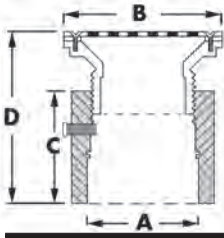

- Strainers are available in PB and NB
- Strainers are 3/16" thick
- Primer tapped, includes 1/2" plug
- Adjustable (see dimension D)

	A	B	C	D
Square	Over 4" pipe	7"	4-3/4"	6-1/16" - 7-3/8"

PART NO.	STRAINER	MATERIAL	CTN QTY
D53267	5" PB	PVC	1
D53277	5" PB	ABS	1
D53268	5" NB	PVC	1
D53278	5" NB	ABS	1

4" Over Pipe Fit Base with 4" Metal Spuds

5" Round Strainer

Fits Over 4" Schedule 40 DWV Pipe

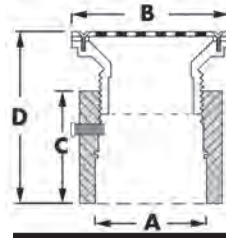

- Strainers are available in PB and NB
- Strainers are 3/16" thick
- Primer tapped, includes 1/2" plug
- Adjustable (see dimension D)

	A	B	C	D
Metal	Over 4" pipe	5"	4-3/4"	6-1/16" - 7-3/8"

PART NO.	STRAINER	MATERIAL	CTN QTY
D53308	5" PB	PVC	4
D53309	5" PB	ABS	4
D53304	5" NB	PVC	4
D53305	5" NB	ABS	4

3" Over Pipe Fit Base with 3" Plastic Spuds

6" Round Strainer

Fits Over 3" Schedule 40 DWV Pipe

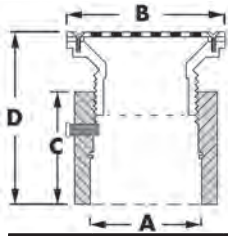

- Stainless steel strainers are .06" thick
- PB, NB and CP strainers are 3/16" thick
- Strainers are available in SS, PB, NB and CP
- Primer tapped, includes 1/2" plug

	A	B	C	D
Without ring	Over 3" pipe	6-1/8"	3-7/8"	4-13/16" – 5-3/4"
With ring	Over 3" pipe	6-1/2"	3-7/8"	4-15/16" – 5-13/16"

PART NO.	STRAINER	MATERIAL	CTN QTY
D53100	6" SS	PVC	1
D53101	6" SS	ABS	1
D53104	6" PB	PVC	1
D53105	6" PB	ABS	1
D53108	6" PB with ring	PVC	1
D53109	6" PB with ring	ABS	1
D53106	6" NB	PVC	1
D53107	6" NB	ABS	1
D53110	6" NB with ring	PVC	1
D53111	6" NB with ring	ABS	1
D53102	6" CP	PVC	1
D53103	6" CP	ABS	1
D53288	6" CP with ring	PVC	1
D53289	6" CP with ring	ABS	1

3" Over Pipe Fit Base with 3" Metal Spuds

5" Round Strainer

Fits Over 3" Schedule 40 DWV Pipe

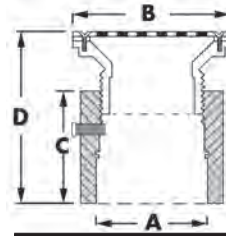

- PB and NB strainers are 3/16" thick
- Strainers are available in PB and NB
- Primer tapped, includes 1/2" plug

	A	B	C	D
Metal spud	Over 3" pipe	5"	3-7/8"	4-15/16" – 5-3/4"

PART NO.	STRAINER	MATERIAL	CTN QTY
D53312	5" PB	PVC	1
D53313	5" PB	ABS	1
D53306	5" NB	PVC	1
D53307	5" NB	ABS	1

3" Over Pipe Fit Base with 3" Plastic Spuds

7" Square Top and 5" Round Strainer

Fits Over 3" Schedule 40 DWV Pipe

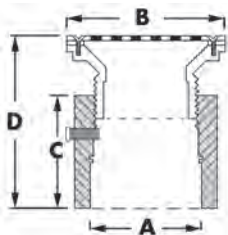

- Strainers are 3/16" thick
- Strainers are available in PB and NB
- Primer tapped, includes 1/2" plug

	A	B	C	D
Square	Over 3" pipe	7"	3-7/8"	4-13/16" – 6-1/8"

PART NO.	STRAINER	MATERIAL	CTN QTY
D53258	5" PB	PVC	1
D53259	5" PB	ABS	1
D53260	5" NB	PVC	1
D53261	5" NB	ABS	1

2" Over Pipe Fit Base with 2" Plastic Spuds

4" Round Strainer

Fits Over 2" Schedule 40 DWV Pipe

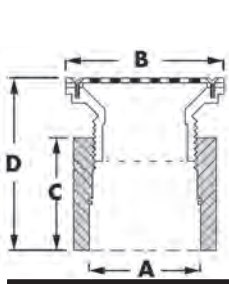

MADE IN THE
USA

- Stainless steel strainers are .06" thick
- Strainers are available in SS, PB, NB and CP
- PB, NB and CP strainers are 3/16" thick
- Adjustable (see dimension D)

	A	B	C	D
Without ring	Over 2" pipe	4-1/4"	1-3/4"	3-3/8" – 3-13/16"
With ring	Over 2" pipe	4-1/4"	1-3/4"	3-1/2" – 3-7/8"

PART NO.	STRAINER	MATERIAL	CTN QTY
D53190	4" SS	PVC	1
D53191	4" SS	ABS	1
D53194	4" PB stamped	PVC	1
D53195	4" PB stamped	ABS	1
D53196	4" PB cast	PVC	1
D53197	4" PB cast	ABS	1
D53200	4" PB with ring	PVC	1
D53201	4" PB with ring	ABS	1
D53198	4" NB	PVC	1
D53199	4" NB	ABS	1
D53202	4" NB with ring	PVC	1
D53203	4" NB with ring	ABS	1
D53192	4" CP	PVC	1
D53193	4" CP	ABS	1
D53290	4" CP with ring	PVC	1
D53291	4" CP with ring	ABS	1

2" Over Pipe Fit Base with 2" Metal Spuds

4" and 6" Round Strainer

Fits Over 2" Schedule 40 DWV Pipe

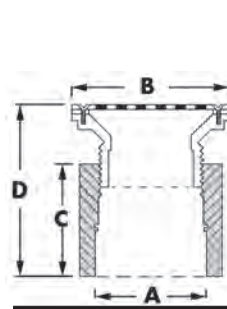

- Stainless steel strainers are .06" thick
- Strainers are available in SS, PB, NB and CP
- PB, NB and CP strainers are 3/16" thick
- Adjustable (see dimension D)

	A	B	C	D
Metal	Over 2" pipe	4-1/4" or 6"	1-3/4"	3-1/8" – 3-5/8"

PART NO.	STRAINER	MATERIAL	CTN QTY
D53204	4" SS	PVC	1
D53205	4" SS	ABS	1
D53208	4" PB	PVC	1
D53209	4" PB	ABS	1
D53206	4" CP	PVC	1
D53207	4" CP	ABS	1
D53218	6" PB	PVC	1
D53219	6" PB	ABS	1
D53216	6" CP	PVC	1
D53217	6" CP	ABS	1

2" Over Pipe Fit Base with 2" Plastic Spuds

4" Square Strainer

Fits Over 2" Schedule 40 DWV Pipe

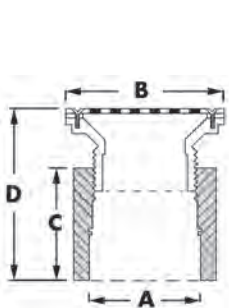

MADE IN THE
USA

- Strainers are available in PB and CP
- Strainers are 3/16" thick
- Adjustable (see dimension D)

	A	B	C	D
Square	Over 2" pipe	4-1/4"	1-3/4"	3-3/16" – 3-11/16"

PART NO.	STRAINER	MATERIAL	CTN QTY
D53298	4" PB	PVC	1
D53299	4" PB	ABS	1
D53296	4" CP	PVC	1
D53297	4" CP	ABS	1

4" Inside Pipe Fit Base with 3" Plastic Spuds

6" Round Strainer

Fits Inside 4" Schedule 40 DWV Pipe

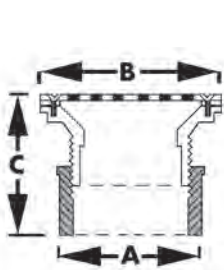

MADE IN THE
USA

- Stainless steel strainers are .06" thick
- Strainers are available in SS, PB, NB and CP
- PB, NB and CP strainers are 3/16" thick
- Adjustable (see dimension C)

	A	B	C
Without ring	Inside 4" pipe	6-1/8"	3-13/16" – 4-5/8"
With ring	Inside 4" pipe	6-1/2"	4" – 4-13/16"

PART NO.	STRAINER	MATERIAL	CTN QTY
D53230	6" SS	PVC	1
D53231	6" SS	ABS	1
D53232	6" PB	PVC	1
D53233	6" PB	ABS	1
D53238	6" PB with ring	PVC	1
D53239	6" PB with ring	ABS	1
D53234	6" NB	PVC	1
D53235	6" NB	ABS	1
D53240	6" NB with ring	PVC	1
D53241	6" NB with ring	ABS	1
D53236	6" CP	PVC	1
D53237	6" CP	ABS	1
D53292	6" CP with ring	PVC	1
D53293	6" CP with ring	ABS	1

4" Inside Pipe Fit Base with 3" Metal Spuds

5" Round Strainer

Fits Inside 4" Schedule 40 DWV Pipe

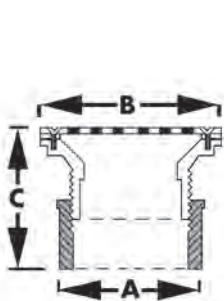

MADE IN THE
USA

- Strainers are available in PB and NB
- Strainers are 3/16" thick
- Adjustable (see dimension C)

	A	B	C
Metal Spud	Inside 4" pipe	5"	2-5/8" – 3-1/2"

PART NO.	STRAINER	MATERIAL	CTN QTY
D53314	5" PB	PVC	1
D53315	5" PB	ABS	1
D53310	5" NB	PVC	1
D53311	5" NB	ABS	1

3" Inside Pipe Fit Base with 2" Plastic Spuds

4" Round Strainer

Fits Inside 3" Schedule 40 DWV Pipe

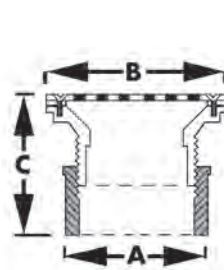

MADE IN THE
USA

- Stainless steel strainers are .06" thick
- Strainers are available in SS, PB, NB and CP
- PB, NB and CP strainers are 3/16" thick
- Adjustable (see dimension C)

	A	B	C
Without ring	Inside 3" pipe	4-1/4"	2-5/8" – 3-7/8"
With ring	Inside 3" pipe	4-1/2"	2-11/16" – 4"

PART NO.	STRAINER	MATERIAL	CTN QTY
D53150	4" SS	PVC	1
D53151	4" SS	ABS	1
D53154	4" PB stamped	PVC	1
D53155	4" PB stamped	ABS	1
D53156	4" PB cast	PVC	1
D53157	4" PB cast	ABS	1
D53160	4" PB with ring	PVC	1
D53161	4" PB with ring	ABS	1
D53158	4" NB	PVC	1
D53159	4" NB	ABS	1
D53162	4" NB with ring	PVC	1
D53163	4" NB with ring	ABS	1
D53152	4" CP	PVC	1
D53153	4" CP	ABS	1
D53294	4" CP with ring	PVC	1
D53295	4" CP with ring	ABS	1

3" Inside Pipe Fit Base with 2" Plastic Spuds

4" Square Strainer

Fits Inside 3" Schedule 40 DWV Pipe

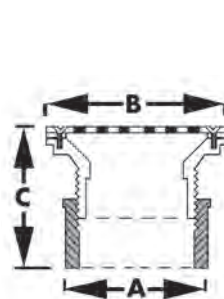

MADE IN THE
USA

- Strainers are available in PB and CP
- Strainers are 3/16" thick
- Adjustable (see dimension C)

	A	B	C
Square	Inside 3" pipe	4-1/4"	2-1/2" – 3-13/16"

PART NO.	STRAINER	MATERIAL	CTN QTY
D53300	4" CP	PVC	1
D53301	4" CP	ABS	1
D53302	4" PB	PVC	1
D53303	4" PB	ABS	1

3" Inside Pipe Fit Base with 2" Metal Spuds

4" or 6" Round Strainer

Fits Inside 3" Schedule 40 DWV Pipe

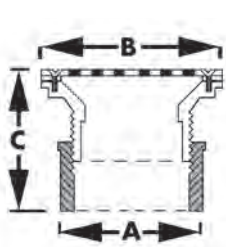

MADE IN THE USA

- Stainless steel strainers are .06" thick
- Strainers are available in SS, PB and CP
- PB and CP strainers are 3/16" thick
- Adjustable (see dimension C)

	A	B	C
Metal Spud	Inside 3" pipe	4-1/4" or 6"	2-7/16" - 3-3/4"

PART NO.	STRAINER	MATERIAL	CTN QTY
D53180	4" SS	PVC	1
D53181	4" SS	ABS	1
D53184	4" PB	PVC	1
D53185	4" PB	ABS	1
D53182	4" CP	PVC	1
D53183	4" CP	ABS	1
D53188	6" PB	PVC	1
D53189	6" PB	ABS	1
D53186	6" CP	PVC	1
D53187	6" CP	ABS	1

4" Hub Fit Base with 3-1/2" Plastic Spuds

6" Round Strainer

Fits Inside 4" Schedule 40 DWV Pipe

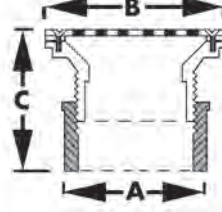

MADE IN THE USA

- Stainless steel strainers are .06" thick
- Strainers are available in SS, PB, NB and CP
- PB, NB and CP strainers are 3/16" thick
- Adjustable (see dimension C)

	A	B	C
Without ring	4" hub fit	6-1/8"	3-1/16" - 4-11/16"
With ring	4" hub fit	6-1/2"	3-1/4" - 4-3/4"

PART NO.	STRAINER	MATERIAL	CTN QTY
D53017	6" SS	PVC	1
D53018	6" SS	ABS	1
D53001	6" PB	PVC	1
D53002	6" PB	ABS	1
D53060	6" PB with ring	PVC	1
D53061	6" PB with ring	ABS	1
D53058	6" NB	PVC	1
D53059	6" NB	ABS	1
D53062	6" NB with ring	PVC	1
D53063	6" NB with ring	ABS	1
D53003	6" CP	PVC	1
D53004	6" CP	ABS	1
D53280	6" CP with ring	PVC	1
D53281	6" CP with ring	ABS	1

4" Hub Fit Base with 3-1/2" Plastic Spuds

5" Round Strainer

Fits Inside 4" Schedule 40 DWV Pipe

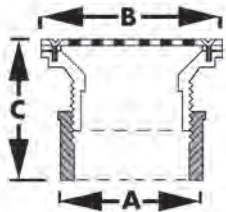

MADE IN THE USA

- Stainless steel strainers are .06" thick
- Strainers are available in SS, PB, NB and CP
- PB, NB and CP strainers are 3/16" thick
- Adjustable (see dimension C)

	A	B	C
Without ring	4" hub fit	5-3/16"	3" - 4-1/2"
With ring	4" hub fit	5-1/2"	3-1/8" - 4-5/8"

PART NO.	STRAINER	MATERIAL	CTN QTY
D53400	5" SS	PVC	1
D53407	5" SS	ABS	1
D53401	5" PB	PVC	1
D53408	5" PB	ABS	1
D53402	5" PB with ring	PVC	1
D53409	5" PB with ring	ABS	1
D53403	5" NB	PVC	1
D53410	5" NB	ABS	1
D53404	5" NB with ring	PVC	1
D53411	5" NB with ring	ABS	1
D53405	5" CP	PVC	1
D53412	5" CP	ABS	1
D53406	5" CP with ring	PVC	1
D53413	5" CP with ring	ABS	1

4" Hub Fit Base with 3-1/2" Metal Spuds

5" or 6" Round Strainer

Fits Inside 4" Schedule 40 DWV Pipe

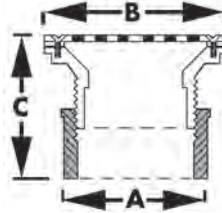

- Strainers are available in PB, NB and CP
- Strainers are 3/16" thick
- Adjustable (see dimension C)

	A	B	C
Round	5" hub fit	5-3/16"	2-3/8" - 3-5/8"
Round	6" hub fit	6-3/16"	2-5/8" - 4"
Round	4" hub fit	8"	2-7/8" - 4-1/2"
Round	4" hub fit	9"	2-7/8" - 4-1/2"

PART NO.	STRAINER	MATERIAL	CTN QTY
D53005	5" PB	PVC	1
D53008	5" PB	ABS	1
D53120	5" NB	PVC	1
D53122	5" NB	ABS	1
D53011	5" CP	PVC	1
D53014	5" CP	ABS	1
D53006	6" PB	PVC	1
D53009	6" PB	ABS	1
D53121	6" NB	PVC	1
D53123	6" NB	ABS	1
D53012	6" CP	PVC	1
D53015	6" CP	ABS	1

4" Hub Fit Base with 3-1/2" Metal Spuds

5" or 6" Square Strainer

Fits Inside 4" Schedule 40 DWV Pipe

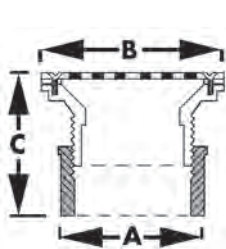

- Strainers are available in PB and NB
- Strainers are 3/16" thick
- Adjustable (see dimension C)

	A	B	C
Square	4" hub fit	5" or 6"	2-3/4" – 4-3/16"

PART NO.	STRAINER	MATERIAL	CTN QTY
D53064	5" PB	PVC	4
D53065	5" PB	ABS	4
D53068	5" NB	PVC	4
D53069	5" NB	ABS	4
D53066	6" PB	PVC	4
D53067	6" PB	ABS	4
D53070	6" NB	PVC	4
D53071	6" NB	ABS	4

4" Heavy Duty Drain Base with 3-1/2" Plastic Spuds

6" Round Strainer

Fits Over 4" Schedule 40 DWV Pipe

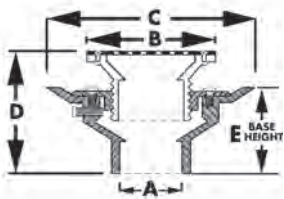

MADE IN THE USA

- Completely adjustable; reversible clamping ring gains additional 1" height
- Strainers are available in SS, PB, NB and CP
- 8-1/2" pan primer tapped with 1/2" plug
- Gray PVC / Black ABS
- Extra weep holes

	A	B	C	D	E
without ring (SS str.)	Over 4"	6-1/8"	8-9/16"	5-9/16" – 6-11/16"	4-1/4"
without ring	Over 4"	6-1/8"	8-9/16"	5-5/8" – 6-7/8"	4-1/4"
with ring	Over 4"	6-7/16"	8-9/16"	5-13/16" – 7"	4-1/4"

PART NO.	STRAINER	MATERIAL	CTN QTY
D49201	6" SS	PVC	1
D49202	6" SS	ABS	1
D49203	6" PB	PVC	1
D49204	6" PB	ABS	1
D49205	6" PB with ring	PVC	1
D49206	6" PB with ring	ABS	1
D49207	6" NB	PVC	1
D49208	6" NB	ABS	1
D49209	6" NB with ring	PVC	1
D49210	6" NB with ring	ABS	1
D49211	6" CP	PVC	1
D49212	6" CP	ABS	1
D49213	6" CP with ring	PVC	1
D49214	6" CP with ring	ABS	1

4" Heavy Duty Drain Base with 3" Metal Spuds

5" Round Strainer

Fits Over 4" Schedule 40 DWV Pipe

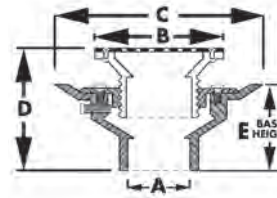

MADE IN THE USA

- Completely adjustable; reversible clamping ring gains additional 1" height
- Strainers are available in PB and NB
- 8-1/2" pan primer tapped with 1/2" plug
- Gray PVC / Black ABS
- Extra weep holes

	A	B	C	D	E
Metal	Over 4"	5-3/16"	8-9/16"	4-11/16" – 5-7/8"	4-1/4"

PART NO.	STRAINER	MATERIAL	CTN QTY
D49219	5" PB	PVC	1
D49220	5" PB	ABS	1
D49221	5" NB	PVC	1
D49222	5" NB	ABS	1

4" Heavy Duty Drain Base with 3-1/2" Plastic Spuds

5" Round Strainer

Fits Over 4" Schedule 40 DWV Pipe

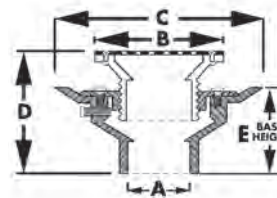

MADE IN THE USA

- Completely adjustable; reversible clamping ring gains additional 1" height
- Strainers are available in SS, PB, NB and CP
- 8-1/2" pan primer tapped with 1/2" plug
- Gray PVC / Black ABS
- Extra weep holes

	A	B	C	D	E
without ring (SS str.)	Over 4"	5-1/4"	8-9/16"	5-1/8" – 6-5/8"	4-1/4"
without ring	Over 4"	5-1/4"	8-9/16"	5-3/16" – 6-3/4"	4-1/4"
with ring	Over 4"	5-9/16"	8-9/16"	5-1/4" – 6-13/16"	4-1/4"

PART NO.	STRAINER	MATERIAL	CTN QTY
D49223	5" SS	PVC	1
D49224	5" SS	ABS	1
D49225	5" PB	PVC	1
D49226	5" PB	ABS	1
D49227	5" PB with ring	PVC	1
D49228	5" PB with ring	ABS	1
D49229	5" NB	PVC	1
D49230	5" NB	ABS	1
D49231	5" NB with ring	PVC	1
D49232	5" NB with ring	ABS	1
D49233	5" CP	PVC	1
D49234	5" CP	ABS	1
D49235	5" CP with ring	PVC	1
D49236	5" CP with ring	ABS	1

4" Heavy Duty Drain Base with 3-1/2" Plastic Spuds

6" Round Strainer

Fits Over 4" Schedule 40 DWV Pipe



MADE IN THE
USA

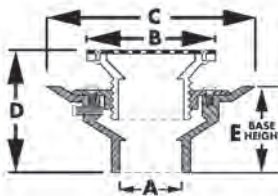

- Completely adjustable; reversible clamping ring gains additional 1" height
- Strainers are available in SS, PB, NB and CP
- 8-1/2" pan primer tapped with 1/2" plug
- Gray PVC / Black ABS
- Extra weep holes

	A	B	C	D	E
without ring (SS str.)	Over 4"	6-1/4"	8-9/16"	5-5/16" – 6-3/4"	4-1/4"
without ring	Over 4"	6-1/4"	8-9/16"	5-7/16" – 6-13/16"	4-1/4"
with ring	Over 4"	6-9/16"	8-9/16"	5-9/16" – 7"	4-1/4"

PART NO.	STRAINER	MATERIAL	CTN QTY
D49237	6" SS	PVC	1
D49238	6" SS	ABS	1
D49239	6" PB	PVC	1
D49240	6" PB	ABS	1
D49241	6" PB with ring	PVC	1
D49242	6" PB with ring	ABS	1
D49243	6" NB	PVC	1
D49244	6" NB	ABS	1
D49245	6" NB with ring	PVC	1
D49246	6" NB with ring	ABS	1
D49247	6" CP	PVC	1
D49248	6" CP	ABS	1
D49249	6" CP with ring	PVC	1
D49250	6" CP with ring	ABS	1

4" Heavy Duty Drain Base with 3-1/2" Metal Spuds

4", 5" or 6" Round Strainer

Fits Over 4" Schedule 40 DWV Pipe

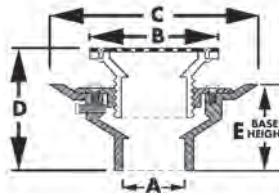

- Completely adjustable; reversible clamping ring gains additional 1" height
- Strainers are available in PB, NB and CP
- 8-1/2" pan primer tapped with 1/2" plug
- Gray PVC / Black ABS
- Extra weep holes

	A	B	C	D	E
4" metal	Over 4"	4-1/8"	8-9/16"	4-5/8" – 5-3/4"	4-1/4"
5" metal	Over 4"	5-3/16"	8-9/16"	4-5/8" – 5-13/16"	4-1/4"
6" metal	Over 4"	6-3/16"	8-9/16"	4-13/16" – 6-1/4"	4-1/4"

PART NO.	STRAINER	MATERIAL	CTN QTY
D49251	4" PB	PVC	1
D49252	4" PB	ABS	1
D49253	4" NB	PVC	1
D49254	4" NB	ABS	1
D49255	5" PB	PVC	1
D49256	5" PB	ABS	1
D49257	5" NB	PVC	1
D49258	5" NB	ABS	1
D49259	5" CP	PVC	1
D49260	5" CP	ABS	1
D49261	6" PB	PVC	1
D49262	6" PB	ABS	1
D49263	6" NB	PVC	1
D49264	6" NB	ABS	1
D49265	6" CP	PVC	1
D49266	6" CP	ABS	1

4" Heavy Duty Drain Base with 4" Plastic Spuds

6" Round Strainer

Fits Over 4" Schedule 40 DWV Pipe

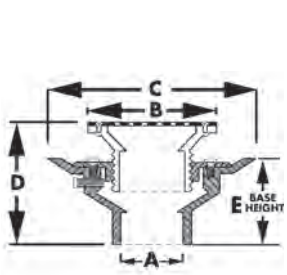

MADE IN THE USA

- Completely adjustable; reversible clamping ring gains additional 1" height
- Strainers are available in SS, PB, NB and CP
- 8-1/2" pan primer tapped with 1/2" plug
- Gray PVC / Black ABS
- Extra weep holes

	A	B	C	D	E
without ring (SS str.)	Over 4"	6-3/16"	8-9/16"	5-1/2" — 6-11/16"	4-1/4"
without ring	Over 4"	6-3/16"	8-9/16"	5-9/16" — 6-3/4"	4-1/4"
with ring	Over 4"	6-7/16"	8-9/16"	5-3/4" — 7"	4-1/4"

PART NO.	STRAINER	MATERIAL	CTN QTY
D49277	6" SS	PVC	1
D49278	6" SS	ABS	1
D49279	6" PB	PVC	1
D49280	6" PB	ABS	1
D49281	6" PB with ring	PVC	1
D49282	6" PB with ring	ABS	1
D49283	6" NB	PVC	1
D49284	6" NB	ABS	1
D49285	6" NB with ring	PVC	1
D49286	6" NB with ring	ABS	1
D49287	6" CP	PVC	1
D49288	6" CP	ABS	1
D49289	6" CP with ring	PVC	1
D49290	6" CP with ring	ABS	1

3" x 4" Heavy Duty Drain Base with 3" Plastic Spuds

6" Round Strainer

Fits Over 3" and Inside 4" Schedule 40 DWV Pipe

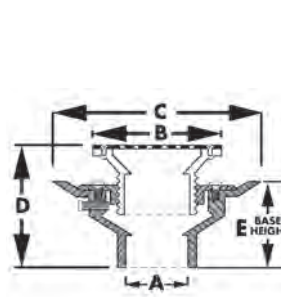

MADE IN THE USA

- Completely adjustable; reversible clamping ring gains additional 1" height
- Strainers are available in SS, PB, NB and CP
- 8-1/2" pan primer tapped with 1/2" plug
- Gray PVC / Black ABS
- Extra weep holes

	A	B	C	D	E
without ring (SS str.)	Over 3" Inside 4"	6-1/8"	8-9/16"	5-1/16" — 6-3/16"	5-3/16"
without ring	Over 3" Inside 4"	6-1/8"	8-9/16"	5-1/8" — 6-3/8"	5-3/16"
with ring	Over 3" Inside 4"	6-7/16"	8-9/16"	5-5/16" — 6-1/2"	5-3/16"

PART NO.	STRAINER	MATERIAL	CTN QTY
D49101	6" SS	PVC	1
D49102	6" SS	ABS	1
D49103	6" PB	PVC	1
D49104	6" PB	ABS	1
D49105	6" PB with ring	PVC	1
D49106	6" PB with ring	ABS	1
D49107	6" NB	PVC	1
D49108	6" NB	ABS	1
D49109	6" NB with ring	PVC	1
D49110	6" NB with ring	ABS	1
D49111	6" CP	PVC	1
D49112	6" CP	ABS	1
D49113	6" CP with ring	PVC	1
D49114	6" CP with ring	ABS	1

4" Heavy Duty Drain Base with 4" Metal Spuds

5" Round Strainer

Fits Over 4" Schedule 40 DWV Pipe

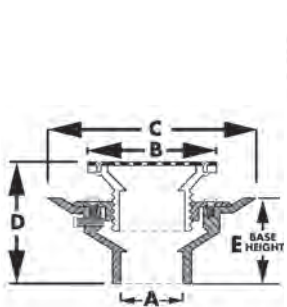

- Completely adjustable; reversible clamping ring gains additional 1" height
- Strainers are available in PB and NB
- 8-1/2" pan primer tapped with 1/2" plug
- Gray PVC / Black ABS
- Extra weep holes

	A	B	C	D	E
Metal	Over 4"	5-3/16"	8-9/16"	4-5/8" — 5-11/16"	4-1/4"

PART NO.	STRAINER	MATERIAL	CTN QTY
D49295	5" PB	PVC	1
D49296	5" PB	ABS	1
D49297	5" NB	PVC	1
D49298	5" NB	ABS	1

3" x 4" Heavy Duty Drain Base with 3" Metal Spuds

5" Round Strainer

Fits Over 3" and Inside 4" Schedule 40 DWV Pipe

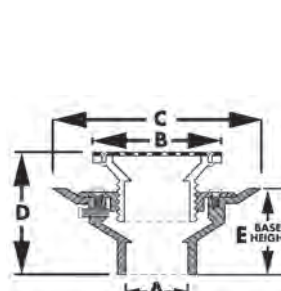

- Completely adjustable; reversible clamping ring gains additional 1" height
- Strainers are available in PB and NB
- 8-1/2" pan primer tapped with 1/2" plug
- Gray PVC / Black ABS
- Extra weep holes

	A	B	C	D	E
Metal	Over 3" Inside 4"	5-3/16"	8-9/16"	4-3/16" — 5-3/8"	5-3/16"

PART NO.	STRAINER	MATERIAL	CTN QTY
D49119	5" PB	PVC	1
D49120	5" PB	ABS	1
D49121	5" NB	PVC	1
D49122	5" NB	ABS	1

3" x 4" Heavy Duty Drain Base with 3-1/2" Plastic Spuds

5" Round Strainer

Fits Over 3" and Inside 4" Schedule 40 DWV Pipe



MADE IN THE
USA

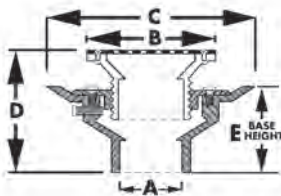

- Completely adjustable; reversible clamping ring gains additional 1" height
- Strainers are available in SS, PB, NB and CP
- 8-1/2" pan primer tapped with 1/2" plug
- Gray PVC / Black ABS
- Extra weep holes

	A	B	C	D	E
without ring (SS str.)	Over 3" Inside 4"	5-1/4"	8-9/16"	4-5/8" — 6-1/8"	5-1/4"
without ring	Over 3" Inside 4"	5-1/4"	8-9/16"	4-11/16" — 6-1/4"	5-1/4"
with ring	Over 3" Inside 4"	5-9/16"	8-9/16"	4-3/4" — 6-5/16"	5-1/4"

PART NO.	STRAINER	MATERIAL	CTN QTY
D49123	5" SS	PVC	1
D49124	5" SS	ABS	1
D49125	5" PB	PVC	1
D49126	5" PB	ABS	1
D49127	5" PB with ring	PVC	1
D49128	5" PB with ring	ABS	1
D49129	5" NB	PVC	1
D49130	5" NB	ABS	1
D49131	5" NB with ring	PVC	1
D49132	5" NB with ring	ABS	1
D49133	5" CP	PVC	1
D49134	5" CP	ABS	1
D49135	5" CP with ring	PVC	1
D49136	5" CP with ring	ABS	1

3" x 4" Heavy Duty Drain Base with 3-1/2" Plastic Spuds

6" Round Strainer

Fits Over 3" and Inside 4" Schedule 40 DWV Pipe



MADE IN THE
USA

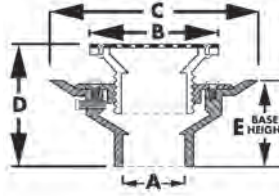

- Completely adjustable; reversible clamping ring gains additional 1" height
- Strainers are available in SS, PB, NB and CP
- 8-1/2" pan primer tapped with 1/2" plug
- Gray PVC / Black ABS
- Extra weep holes

	A	B	C	D	E
without ring (SS str.)	Over 3" Inside 4"	6-1/4"	8-9/16"	4-13/16" — 6-1/4"	5-1/4"
without ring	Over 3" Inside 4"	6-1/4"	8-9/16"	4-15/16" — 6-5/16"	5-1/4"
with ring	Over 3" Inside 4"	6-9/16"	8-9/16"	5-1/16" — 6-1/2"	5-1/4"

PART NO.	STRAINER	MATERIAL	CTN QTY
D49137	6" SS	PVC	1
D49138	6" SS	ABS	1
D49139	6" PB	PVC	1
D49140	6" PB	ABS	1
D49141	6" PB with ring	PVC	1
D49142	6" PB with ring	ABS	1
D49143	6" NB	PVC	1
D49144	6" NB	ABS	1
D49145	6" NB with ring	PVC	1
D49146	6" NB with ring	ABS	1
D49147	6" CP	PVC	1
D49148	6" CP	ABS	1
D49149	6" CP with ring	PVC	1
D49150	6" CP with ring	ABS	1

3" x 4" Heavy Duty Drain Base with 3-1/2" Metal Spuds

4", 5" or 6" Round Strainer

Fits Over 3" and Inside 4" Schedule 40 DWV Pipe

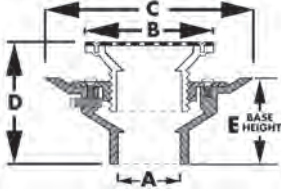

- Completely adjustable; reversible clamping ring gains additional 1" height
- Strainers are available in PB, NB and CP
- 8-1/2" pan primer tapped with 1/2" plug
- Gray PVC / Black ABS
- Extra weep holes

	A	B	C	D	E
4" metal	Over 3" Inside 4"	4-1/8"	8-9/16"	4-1/8" — 5-1/4"	5-1/4"
5" metal	Over 3" Inside 4"	5-3/16"	8-9/16"	4-1/8" — 5-5/16"	5-1/4"
6" metal	Over 3" Inside 4"	6-3/16"	8-9/16"	4-5/16" — 5-3/4"	5-1/4"

PART NO.	STRAINER	MATERIAL	CTN QTY
D49151	4" PB	PVC	1
D49152	4" PB	ABS	1
D49153	4" NB	PVC	1
D49154	4" NB	ABS	1
D49155	5" PB	PVC	1
D49156	5" PB	ABS	1
D49157	5" NB	PVC	1
D49158	5" NB	ABS	1
D49159	5" CP	PVC	1
D49160	5" CP	ABS	1
D49161	6" PB	PVC	1
D49162	6" PB	ABS	1
D49163	6" NB	PVC	1
D49164	6" NB	ABS	1
D49165	6" CP	PVC	1
D49166	6" CP	ABS	1

3" x 4" Heavy Duty Drain Base with 4" Plastic Spuds

6" Round Strainer

Fits Over 3" and Inside 4" Schedule 40 DWV Pipe



MADE IN THE USA

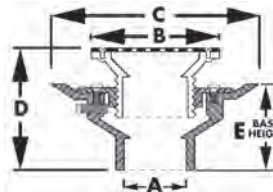

- Completely adjustable; reversible clamping ring gains additional 1" height
- Strainers are available in SS, PB, NB and CP
- 8-1/2" pan primer tapped with 1/2" plug
- Gray PVC / Black ABS
- Extra weep holes

	A	B	C	D	E
Without ring (SS str.)	Over 3" Inside 4"	6-3/16"	8-9/16"	5-1/16" — 6-3/16"	5-1/4"
Without ring	Over 3" Inside 4"	6-3/16"	8-9/16"	5-1/8" — 6-3/8"	5-1/4"
With ring	Over 3" Inside 4"	6-7/16"	8-9/16"	5-5/16" — 6-1/2"	5-1/4"

PART NO.	STRAINER	MATERIAL	CTN QTY
D49177	6" SS	PVC	1
D49178	6" SS	ABS	1
D49179	6" PB	PVC	1
D49180	6" PB	ABS	1
D49181	6" PB with ring	PVC	1
D49182	6" PB with ring	ABS	1
D49183	6" NB	PVC	1
D49184	6" NB	ABS	1
D49185	6" NB with ring	PVC	1
D49186	6" NB with ring	ABS	1
D49187	6" CP	PVC	1
D49188	6" CP	ABS	1
D49189	6" CP with ring	PVC	1
D49190	6" CP with ring	ABS	1

3" x 4" Heavy Duty Drain Base with 4" Metal Spuds

5" Round Strainer

Fits Over 3" and Inside 4" Schedule 40 DWV Pipe

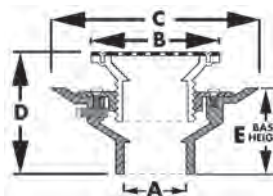

- Completely adjustable; reversible clamping ring gains additional 1" height
- Strainers are available in SS, PB, NB and CP
- 8-1/2" pan primer tapped with 1/2" plug
- Gray PVC / Black ABS
- Extra weep holes

	A	B	C	D	E
Metal	Over 3" Inside 4"	5-3/16"	8-9/16"	4-3/16" — 5-3/8"	5-1/4"

PART NO.	STRAINER	MATERIAL	CTN QTY
D49195	5" PB	PVC	1
D49196	5" PB	ABS	1
D49197	5" NB	PVC	1
D49198	5" NB	ABS	1

2" x 3" Heavy Duty Drain Base with 3" Plastic Spuds

6" Round Strainer

Fits Over 2" and Inside 3" Schedule 40 DWV Pipe



MADE IN THE
USA

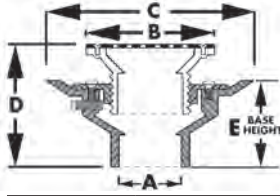

- Completely adjustable; reversible clamping ring gains additional 1" height
- Strainers are available in SS, PB, NB and CP
- 8-1/2" pan primer tapped with 1/2" plug
- Gray PVC / Black ABS
- Extra weep holes

	A	B	C	D	E
Without ring (SS str.)	Over 2" Inside 3"	6-1/8"	8-9/16"	5-1/16" — 6-3/16"	3-3/4"
Without ring	Over 2" Inside 3"	6-1/8"	8-9/16"	5-1/8" — 6-3/8"	3-3/4"
With ring	Over 2" Inside 3"	6-7/16"	8-9/16"	5-5/16" — 6-3/16"	3-3/4"

PART NO.	STRAINER	MATERIAL	CTN QTY
D49001	6" SS	PVC	1
D49002	6" SS	ABS	1
D49003	6" PB	PVC	1
D49004	6" PB	ABS	1
D49005	6" PB with ring	PVC	1
D49006	6" PB with ring	ABS	1
D49007	6" NB	PVC	1
D49008	6" NB	ABS	1
D49009	6" NB with ring	PVC	1
D49010	6" NB with ring	ABS	1
D49011	6" CP	PVC	1
D49012	6" CP	ABS	1
D49013	6" CP with ring	PVC	1
D49014	6" CP with ring	ABS	1

2" x 3" Heavy Duty Drain Base with 3-1/2" Plastic Spuds

5" Round Strainer

Fits Over 2" and Inside 3" Schedule 40 DWV Pipe



MADE IN THE
USA

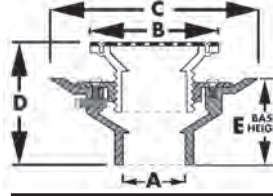

- Completely adjustable; reversible clamping ring gains additional 1" height
- Strainers are available in SS, PB, NB and CP
- 8-1/2" pan primer tapped with 1/2" plug
- Gray PVC / Black ABS
- Extra weep holes

	A	B	C	D	E
Without ring (SS str.)	Over 2" Inside 3"	5-1/4"	8-9/16"	4-5/8" — 6-1/8"	3-3/4"
Without ring	Over 2" Inside 3"	5-1/4"	8-9/16"	4-11/16" — 6-1/4"	3-3/4"
With ring	Over 2" Inside 3"	5-9/16"	8-9/16"	4-3/4" — 6-5/16"	3-3/4"

PART NO.	STRAINER	MATERIAL	CTN QTY
D49023	5" SS	PVC	1
D49024	5" SS	ABS	1
D49025	5" PB	PVC	1
D49026	5" PB	ABS	1
D49027	5" PB with ring	PVC	1
D49028	5" PB with ring	ABS	1
D49029	5" NB	PVC	1
D49030	5" NB	ABS	1
D49031	5" NB with ring	PVC	1
D49032	5" NB with ring	ABS	1
D49033	5" CP	PVC	1
D49034	5" CP	ABS	1
D49035	5" CP with ring	PVC	1
D49036	5" CP with ring	ABS	1

2" x 3" Heavy Duty Drain Base with 3" Metal Spuds

5" Round Strainer

Fits Over 2" and Inside 3" Schedule 40 DWV Pipe

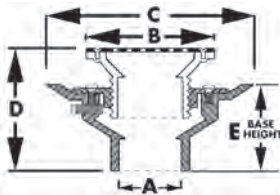

- Completely adjustable; reversible clamping ring gains additional 1" height
- Strainers are available in SS, PB, NB and CP
- 8-1/2" pan primer tapped with 1/2" plug
- Gray PVC / Black ABS
- Extra weep holes

	A	B	C	D	E
Metal	Over 2" Inside 3"	5-3/16"	8-9/16"	4-3/16" — 5-3/8"	3-3/4"

PART NO.	STRAINER	MATERIAL	CTN QTY
D49019	5" PB	PVC	1
D49020	5" PB	ABS	1
D49021	5" NB	PVC	1
D49022	5" NB	ABS	1

2" x 3" Heavy Duty Drain Base with 3-1/2" Plastic Spuds

6" Round Strainer

Fits Over 2" and Inside 3" Schedule 40 DWV Pipe



MADE IN THE
USA

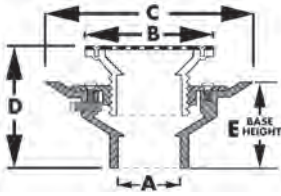

- Completely adjustable; reversible clamping ring gains additional 1" height
- Strainers are available in SS, PB, NB and CP
- 8-1/2" pan primer tapped with 1/2" plug
- Gray PVC / Black ABS
- Extra weep holes

	A	B	C	D	E
Without ring (SS str.)	Over 2" Inside 3"	6-1/4"	8-9/16"	4-13/16" – 6-1/4"	3-3/4"
Without ring	Over 2" Inside 3"	6-1/4"	8-9/16"	4-15/16" – 6-5/16"	3-3/4"
With ring	Over 2" Inside 3"	6-9/16"	8-9/16"	5-1/16" – 6-1/2"	3-3/4"

PART NO.	STRAINER	MATERIAL	CTN QTY
D49037	6" SS	PVC	1
D49038	6" SS	ABS	1
D49039	6" PB	PVC	1
D49040	6" PB	ABS	1
D49041	6" PB with ring	PVC	1
D49042	6" PB with ring	ABS	1
D49043	6" NB	PVC	1
D49044	6" NB	ABS	1
D49045	6" NB with ring	PVC	1
D49046	6" NB with ring	ABS	1
D49047	6" CP	PVC	1
D49048	6" CP	ABS	1
D49049	6" CP with ring	PVC	1
D49050	6" CP with ring	ABS	1

2" x 3" Heavy Duty Drain Base with 3-1/2" Metal Spuds

4", 5" or 6" Round Strainer

Fits Over 2" and Inside 3" Schedule 40 DWV Pipe

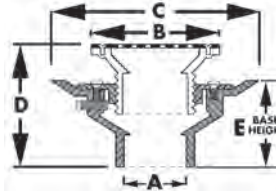

- Completely adjustable; reversible clamping ring gains additional 1" height
- Strainers are available in PB, NB and CP
- 8-1/2" pan primer tapped with 1/2" plug
- Gray PVC / Black ABS
- Extra weep holes

	A	B	C	D	E
4" metal	Over 2" Inside 3"	4-1/8"	8-9/16"	4-1/8" – 5-1/4"	3-3/4"
5" metal	Over 2" Inside 3"	5-3/16"	8-9/16"	4-1/8" – 5-5/16"	3-3/4"
6" metal	Over 2" Inside 3"	6-3/16"	8-9/16"	4-5/16" – 5-3/4"	3-3/4"

PART NO.	STRAINER	MATERIAL	CTN QTY
D49051	4" PB	PVC	1
D49052	4" PB	ABS	1
D49053	4" NB	PVC	1
D49054	4" NB	ABS	1
D49055	5" PB	PVC	1
D49056	5" PB	ABS	1
D49057	5" NB	PVC	1
D49058	5" NB	ABS	1
D49059	5" CP	PVC	1
D49060	5" CP	ABS	1
D49061	6" PB	PVC	1
D49062	6" PB	ABS	1
D49063	6" NB	PVC	1
D49064	6" NB	ABS	1
D49065	6" CP	PVC	1
D49066	6" CP	ABS	1

2" x 3" Heavy Duty Drain Base with 4" Plastic Spuds

6" Round Strainer

Fits Over 2" and Inside 3" Schedule 40 DWV Pipe



MADE IN THE
USA

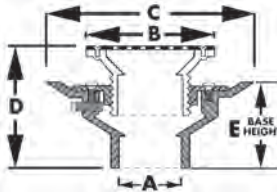

- Completely adjustable; reversible clamping ring gains additional 1" height
- Strainers are available in SS, PB, NB and CP
- 8-1/2" pan primer tapped with 1/2" plug
- Gray PVC / Black ABS
- Extra weep holes

	A	B	C	D	E
Without ring (SS str.)	Over 2" Inside 3"	6-3/16"	8-9/16"	5" - 6-3/16"	3-3/4"
Without ring	Over 2" Inside 3"	6-3/16"	8-9/16"	5-1/16" - 6-1/4"	3-3/4"

PART NO.	STRAINER	MATERIAL	CTN QTY
D49077	6" SS	PVC	1
D49078	6" SS	ABS	1
D49079	6" PB	PVC	1
D49080	6" PB	ABS	1
D49081	6" PB with ring	PVC	1
D49082	6" PB with ring	ABS	1
D49083	6" NB	PVC	1
D49084	6" NB	ABS	1
D49085	6" NB with ring	PVC	1
D49086	6" NB with ring	ABS	1
D49087	6" CP	PVC	1
D49088	6" CP	ABS	1
D49089	6" CP with ring	PVC	1
D49090	6" CP with ring	ABS	1

2" x 3" Heavy Duty Drain Base with 4" Metal Spuds

5" Round Strainer

Fits Over 2" and Inside 3" Schedule 40 DWV Pipe

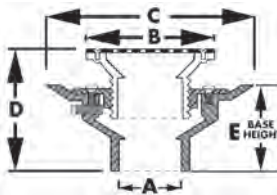

- Completely adjustable; reversible clamping ring gains additional 1" height
- Strainers are available in SS, PB, NB and CP
- 8-1/2" pan primer tapped with 1/2" plug
- Gray PVC / Black ABS
- Extra weep holes

	A	B	C	D	E
Metal	Over 2" Inside 3"	5-3/16"	8-9/16"	4-1/8" - 5-3/16"	3-3/4"

PART NO.	STRAINER	MATERIAL	CTN QTY
D49095	5" PB	PVC	1
D49096	5" PB	ABS	1
D49097	5" NB	PVC	1
D49098	5" NB	ABS	1

4" Heavy Duty Slab Drain Base with 3" Plastic Spuds

6" Round Strainer

Fits Over 4" Schedule 40 DWV Pipe



MADE IN THE
USA

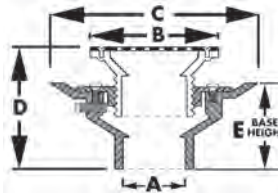

- 8-1/2" pan for applications where no clamping ring is required
- Strainers are available in SS, PB, NB and CP
- Spud threads directly into base
- Primer tapped with 1/2" plug
- Gray PVC / Black ABS
- Completely adjustable

	A	B	C	D	E
Without ring (SS str.)	Over 4"	6-1/8"	8-9/16"	5-5/16" - 6-3/8"	4-3/16"
Without ring	Over 4"	6-1/8"	8-9/16"	5-3/8" - 6-5/16"	4-3/16"
With ring	Over 4"	6-7/16"	8-9/16"	5-1/8" - 6-9/16"	4-3/16"

PART NO.	STRAINER	MATERIAL	CTN QTY
D49501	6" SS	PVC	1
D49502	6" SS	ABS	1
D49503	6" PB	PVC	1
D49504	6" PB	ABS	1
D49505	6" PB with ring	PVC	1
D49506	6" PB with ring	ABS	1
D49507	6" NB	PVC	1
D49508	6" NB	ABS	1
D49509	6" NB with ring	PVC	1
D49510	6" NB with ring	ABS	1
D49511	6" CP	PVC	1
D49512	6" CP	ABS	1
D49513	6" CP with ring	PVC	1
D49514	6" CP with ring	ABS	1

4" Heavy Duty Slab Drain Base with 3" Metal Spuds

5" Round Strainer

Fits Over 4" Schedule 40 DWV Pipe

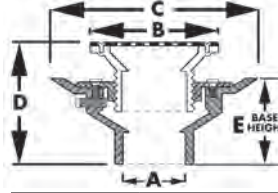

- 8-1/2" pan for applications where no clamping ring is required
- Strainers are available in PB and NB
- Spud threads directly into base
- Primer tapped with 1/2" plug
- Gray PVC / Black ABS
- Completely adjustable

	A	B	C	D	E
Metal	Over 4"	5-3/16"	8-9/16"	4-5/16" - 5-3/8"	4-3/16"

PART NO.	STRAINER	MATERIAL	CTN QTY
D49519	5" PB	PVC	1
D49520	5" PB	ABS	1
D49521	5" NB	PVC	1
D49522	5" NB	ABS	1

4" Heavy Duty Slab Drain Base with 3-1/2" Plastic Spuds

5" Round Strainer

Fits Over 4" Schedule 40 DWV Pipe



MADE IN THE
USA

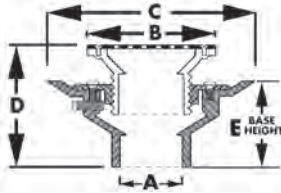

- 8-1/2" pan for applications where no clamping ring is required
- Strainers are available in SS, PB, NB and CP
- Spud threads directly into base
- Primer tapped with 1/2" plug
- Gray PVC / Black ABS
- Completely adjustable

	A	B	C	D	E
Without ring (SS str.)	Over 4"	5-1/4"	8-9/16"	5-1/4" – 6-7/16"	4-3/16"
Without ring	Over 4"	5-1/4"	8-9/16"	5-3/8" – 6-7/16"	4-3/16"
With ring	Over 4"	5-9/16"	8-9/16"	5-9/16" – 6-5/8"	4-3/16"

PART NO.	STRAINER	MATERIAL	CTN QTY
D49523	5" SS	PVC	1
D49524	5" SS	ABS	1
D49525	5" PB	PVC	1
D49526	5" PB	ABS	1
D49527	5" PB with ring	PVC	1
D49528	5" PB with ring	ABS	1
D49529	5" NB	PVC	1
D49530	5" NB	ABS	1
D49531	5" NB with ring	PVC	1
D49532	5" NB with ring	ABS	1
D49533	5" CP	PVC	1
D49534	5" CP	ABS	1
D49535	5" CP with ring	PVC	1
D49536	5" CP with ring	ABS	1

4" Heavy Duty Slab Drain Base with 3-1/2" Plastic Spuds

6" Round Strainer

Fits Over 4" Schedule 40 DWV Pipe



MADE IN THE
USA

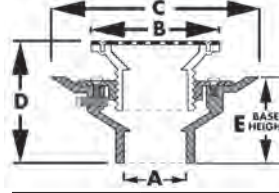

- 8-1/2" pan for applications where no clamping ring is required
- Strainers are available in SS, PB, NB and CP
- Spud threads directly into base
- Primer tapped with 1/2" plug
- Gray PVC / Black ABS
- Completely adjustable

	A	B	C	D	E
Without ring (SS str.)	Over 4"	6-1/4"	8-9/16"	5-3/8" – 6-7/16"	4-3/16"
Without ring	Over 4"	6-1/4"	8-9/16"	5-7/16" – 6-7/16"	4-3/16"
With ring	Over 4"	6-9/16"	8-9/16"	5-1/2" – 6-5/8"	4-3/16"

PART NO.	STRAINER	MATERIAL	CTN QTY
D49537	6" SS	PVC	1
D49538	6" SS	ABS	1
D49539	6" PB	PVC	1
D49540	6" PB	ABS	1
D49541	6" PB with ring	PVC	1
D49542	6" PB with ring	ABS	1
D49543	6" NB	PVC	1
D49544	6" NB	ABS	1
D49545	6" NB with ring	PVC	1
D49546	6" NB with ring	ABS	1
D49547	6" CP	PVC	1
D49548	6" CP	ABS	1
D49549	6" CP with ring	PVC	1
D49550	6" CP with ring	ABS	1

4" Heavy Duty Slab Drain Base with 3-1/2" Metal Spuds

4", 5" or 6" Round Strainer

Fits Over 4" Schedule 40 DWV Pipe

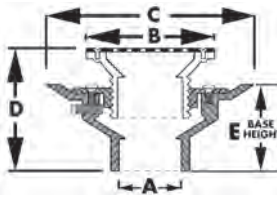

- 8-1/2" pan for applications where no clamping ring is required
- Strainers are available in PB, NB and CP
- Spud threads directly into base
- Primer tapped with 1/2" plug
- Gray PVC / Black ABS
- Completely adjustable

	A	B	C	D	E
4" metal	Over 4"	4-1/8"	8-9/16"	4-7/16" — 5-7/16"	4-3/16"
5" metal	Over 4"	5-3/16"	8-9/16"	4-5/16" — 5-7/16"	4-3/16"
6" metal	Over 4"	6-3/16"	8-9/16"	4-13/16" — 5-13/16"	4-3/16"

PART NO.	STRAINER	MATERIAL	CTN QTY
D49551	4" PB	PVC	1
D49552	4" PB	ABS	1
D49553	4" NB	PVC	1
D49554	4" NB	ABS	1
D49555	5" PB	PVC	1
D49556	5" PB	ABS	1
D49557	5" NB	PVC	1
D49558	5" NB	ABS	1
D49559	5" CP	PVC	1
D49560	5" CP	ABS	1
D49561	6" PB	PVC	1
D49562	6" PB	ABS	1
D49563	6" NB	PVC	1
D49564	6" NB	ABS	1
D49565	6" CP	PVC	1
D49566	6" CP	ABS	1

4" Heavy Duty Slab Drain Base with 4" Plastic Spuds

6" Round Strainer

Fits Over 4" Schedule 40 DWV Pipe



MADE IN THE USA

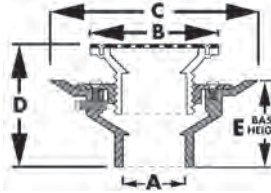

- 8-1/2" pan for applications where no clamping ring is required
- Strainers are available in SS, PB, NB and CP
- Spud threads directly into base
- Primer tapped with 1/2" plug
- Gray PVC / Black ABS
- Completely adjustable

	A	B	C	D	E
Without ring (SS str.)	Over 4"	6-3/16"	8-9/16"	5-3/8" — 6-3/8"	4-3/16"
Without ring	Over 4"	6-3/16"	8-9/16"	5-7/16" — 6-7/16"	4-3/16"
With ring	Over 4"	6-7/16"	8-9/16"	5-5/8" — 6-9/16"	4-3/16"

PART NO.	STRAINER	MATERIAL	CTN QTY
D49577	6" SS	PVC	1
D49578	6" SS	ABS	1
D49579	6" PB	PVC	1
D49580	6" PB	ABS	1
D49581	6" PB with ring	PVC	1
D49582	6" PB with ring	ABS	1
D49583	6" NB	PVC	1
D49584	6" NB	ABS	1
D49585	6" NB with ring	PVC	1
D49586	6" NB with ring	ABS	1
D49587	6" CP	PVC	1
D49588	6" CP	ABS	1
D49589	6" CP with ring	PVC	1
D49590	6" CP with ring	ABS	1

4" Heavy Duty Slab Drain Base with 4" Metal Spuds

5" Round Strainer

Fits Over 4" Schedule 40 DWV Pipe

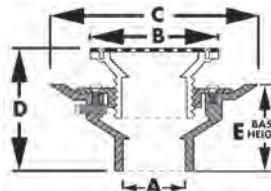

- 8-1/2" pan for applications where no clamping ring is required
- Strainers are available in PB and NB
- Spud threads directly into base
- Primer tapped with 1/2" plug
- Gray PVC / Black ABS
- Completely adjustable

	A	B	C	D	E
Metal	Over 4"	5-3/16"	8-9/16"	4-1/4" — 5-5/16"	4-3/16"

PART NO.	STRAINER	MATERIAL	CTN QTY
D49595	5" PB	PVC	1
D49596	5" PB	ABS	1
D49597	5" NB	PVC	1
D49598	5" NB	ABS	1

3" x 4" Heavy Duty Slab Drain Base with 3" Plastic Spuds

6" Round Strainer

Fits Over 3" and Inside 4" Schedule 40 DWV Pipe



MADE IN THE USA

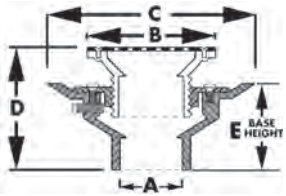

- 8-1/2" pan for applications where no clamping ring is required
- Strainers are available in SS, PB, NB and CP
- Spud threads directly into base
- Primer tapped with 1/2" plug
- Gray PVC / Black ABS
- Completely adjustable

	A	B	C	D	E
Without ring (SS str.)	Over 3" Inside 4"	6-1/8"	8-9/16"	5-1/16" — 6-1/16"	3-3/4"
Without ring	Over 3" Inside 4"	6-1/8"	8-9/16"	5-1/8" — 6-3/16"	3-3/4"
With ring	Over 3" Inside 4"	6-7/16"	8-9/16"	5-5/16" — 6-3/8"	3-3/4"

PART NO.	STRAINER	MATERIAL	CTN QTY
D49401	6" SS	PVC	1
D49402	6" SS	ABS	1
D49403	6" PB	PVC	1
D49404	6" PB	ABS	1
D49405	6" PB with ring	PVC	1
D49406	6" PB with ring	ABS	1
D49407	6" NB	PVC	1
D49408	6" NB	ABS	1
D49409	6" NB with ring	PVC	1
D49410	6" NB with ring	ABS	1
D49411	6" CP	PVC	1
D49412	6" CP	ABS	1
D49413	6" CP with ring	PVC	1
D49414	6" CP with ring	ABS	1

3" x 4" Heavy Duty Slab Drain Base with 3" Metal Spuds

5" Round Strainer

Fits Over 3" and Inside 4" Schedule 40 DWV Pipe



MADE IN THE USA

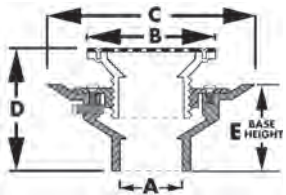

- 8-1/2" pan for applications where no clamping ring is required
- Strainers are available in PB and NB
- Spud threads directly into base
- Primer tapped with 1/2" plug
- Gray PVC / Black ABS
- Completely adjustable

	A	B	C	D	E
Metal	Over 3" Inside 4"	5-3/16"	8-9/16"	4-1/8" — 5-1/8"	3-3/4"

PART NO.	STRAINER	MATERIAL	CTN QTY
D49419	5" PB	PVC	1
D49420	5" PB	ABS	1
D49421	5" NB	PVC	1
D49422	5" NB	ABS	1

3" x 4" Heavy Duty Slab Drain Base with 3-1/2" Plastic Spuds

5" Round Strainer

Fits Over 3" and Inside 4" Schedule 40 DWV Pipe



MADE IN THE USA

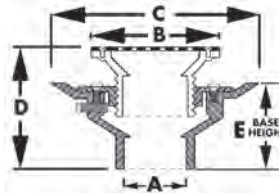

- 8-1/2" pan for applications where no clamping ring is required
- Strainers are available in SS, PB, NB and CP
- Spud threads directly into base
- Primer tapped with 1/2" plug
- Gray PVC / Black ABS
- Completely adjustable

	A	B	C	D	E
Without ring (SS str.)	Over 3" Inside 4"	5-1/4"	8-9/16"	5" — 6-1/8"	3-3/4"
Without ring	Over 3" Inside 4"	5-1/4"	8-9/16"	5-3/16" — 6-3/16"	3-3/4"
With ring	Over 3" Inside 4"	5-9/16"	8-9/16"	5-3/8" — 6-5/16"	3-3/4"

PART NO.	STRAINER	MATERIAL	CTN QTY
D49423	5" SS	PVC	1
D49424	5" SS	ABS	1
D49425	5" PB	PVC	1
D49426	5" PB	ABS	1
D49427	5" PB with ring	PVC	1
D49428	5" PB with ring	ABS	1
D49429	5" NB	PVC	1
D49430	5" NB	ABS	1
D49431	5" NB with ring	PVC	1
D49432	5" NB with ring	ABS	1
D49433	5" CP	PVC	1
D49434	5" CP	ABS	1
D49435	5" CP with ring	PVC	1
D49436	5" CP with ring	ABS	1

3" x 4" Heavy Duty Slab Drain Base with 3-1/2" Plastic Spuds

6" Round Strainer

Fits Over 3" and Inside 4" Schedule 40 DWV Pipe



MADE IN THE
USA

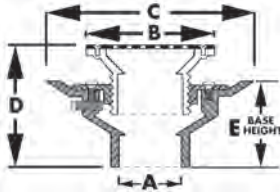

- 8-1/2" pan for applications where no clamping ring is required
- Strainers are available in SS, PB, NB and CP
- Spud threads directly into base
- Primer tapped with 1/2" plug
- Gray PVC / Black ABS
- Completely adjustable

	A	B	C	D	E
Without ring (SS str.)	Over 3" Inside 4"	6-1/4"	8-9/16"	5-1/16" - 6-1/16"	3-3/4"
Without ring	Over 3" Inside 4"	6-1/4"	8-9/16"	5-3/16" - 6-3/16"	3-3/4"
With ring	Over 3" Inside 4"	6-9/16"	8-9/16"	5-5/16" - 6-3/8"	3-3/4"

PART NO.	STRAINER	MATERIAL	CTN QTY
D49437	6" SS	PVC	1
D49438	6" SS	ABS	1
D49439	6" PB	PVC	1
D49440	6" PB	ABS	1
D49441	6" PB with ring	PVC	1
D49442	6" PB with ring	ABS	1
D49443	6" NB	PVC	1
D49444	6" NB	ABS	1
D49445	6" NB with ring	PVC	1
D49446	6" NB with ring	ABS	1
D49447	6" CP	PVC	1
D49448	6" CP	ABS	1
D49449	6" CP with ring	PVC	1
D49450	6" CP with ring	ABS	1

3" x 4" Heavy Duty Slab Drain Base with 3-1/2" Metal Spuds

4", 5", 6", 8" or 9" Round Strainer

Fits Over 3" and Inside 4" Schedule 40 DWV Pipe



MADE IN THE
USA

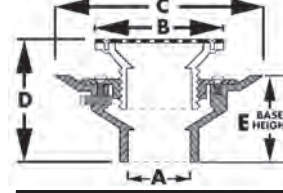

- 8-1/2" pan for applications where no clamping ring is required
- Strainers are available in PB, NB and CP
- Spud threads directly into base
- Primer tapped with 1/2" plug
- Gray PVC / Black ABS
- Completely adjustable

	A	B	C	D	E
4" round	Over 3" Inside 4"	4-1/8"	8-9/16"	4-1/8" - 5-1/16"	3-15/16"
5" round	Over 3" Inside 4"	5-3/16"	8-9/16"	4-1/8" - 5-1/4"	3-15/16"
6" round	Over 3" Inside 4"	6-3/16"	8-9/16"	4-9/16" - 5-7/16"	3-15/16"
8" round	Over 3" Inside 4"	8-1/8"	8-9/16"	5-1/16" - 6"	3-15/16"
9" round	Over 3" Inside 4"	9"	8-9/16"	5" - 6-1/8"	3-15/16"

PART NO.	STRAINER	MATERIAL	CTN QTY
D49451	4" PB	PVC	1
D49452	4" PB	ABS	1
D49453	4" NB	PVC	1
D49454	4" NB	ABS	1
D49455	5" PB	PVC	1
D49456	5" PB	ABS	1
D49457	5" NB	PVC	1
D49458	5" NB	ABS	1
D49459	5" CP	PVC	1
D49460	5" CP	ABS	1
D49461	6" PB	PVC	1
D49462	6" PB	ABS	1
D49463	6" NB	PVC	1
D49464	6" NB	ABS	1
D49465	6" CP	PVC	1
D49466	6" CP	ABS	1
D49467	8" PB	PVC	1
D49468	8" PB	ABS	1
D49469	8" NB	PVC	1
D49470	8" NB	ABS	1
D49471	8" CP	PVC	1
D49472	8" CP	ABS	1
D49473	9" PB	PVC	1
D49474	9" PB	ABS	1
D49475	9" NB	PVC	1
D49476	9" NB	ABS	1

3" x 4" Heavy Duty Slab Drain Base with 4" Plastic Spuds

6" Round Strainer

Fits Over 3" and Inside 4" Schedule 40 DWV Pipe

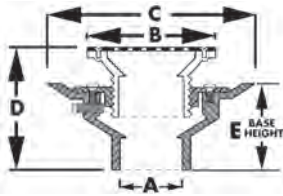

- 8-1/2" pan for applications where no clamping ring is required
- Strainers are available in SS, PB, NB and CP
- Spud threads directly into base
- Primer tapped with 1/2" plug
- Gray PVC / Black ABS
- Completely adjustable

	A	B	C	D	E
Without ring (SS str.)	Over 3" Inside 4"	6-3/16"	8-9/16"	5-1/16" – 6-1/8"	3-15/16"
Without ring	Over 3" Inside 4"	6-3/16"	8-9/16"	5-1/4" – 6-3/16"	3-15/16"
With ring	Over 3" Inside 4"	6-7/16"	8-9/16"	5-3/8" – 6-5/16"	3-15/16"

PART NO.	STRAINER	MATERIAL	CTN QTY
D49477	6" SS	PVC	1
D49478	6" SS	ABS	1
D49479	6" PB	PVC	1
D49480	6" PB	ABS	1
D49481	6" PB with ring	PVC	1
D49482	6" PB with ring	ABS	1
D49483	6" NB	PVC	1
D49484	6" NB	ABS	1
D49485	6" NB with ring	PVC	1
D49486	6" NB with ring	ABS	1
D49487	6" CP	PVC	1
D49488	6" CP	ABS	1
D49489	6" CP with ring	PVC	1
D49490	6" CP with ring	ABS	1

3" x 4" Heavy Duty Slab Drain Base with 4" Metal Spuds

5" Round Strainer

Fits Over 3" and Inside 4" Schedule 40 DWV Pipe

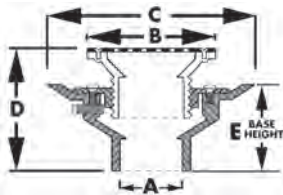

- 8-1/2" pan for applications where no clamping ring is required
- Strainers are available in PB and NB
- Spud threads directly into base
- Primer tapped with 1/2" plug
- Gray PVC / Black ABS
- Completely adjustable

	A	B	C	D	E
Metal	Over 3" Inside 4"	5-3/16"	8-9/16"	4" – 5-1/8"	3-15/16"

PART NO.	STRAINER	MATERIAL	CTN QTY
D49495	5" PB	PVC	1
D49496	5" PB	ABS	1
D49497	5" NB	PVC	1
D49498	5" NB	ABS	1

2" x 3" Heavy Duty Slab Drain Base with 3" Plastic Spuds

6" Round Strainer

Fits Over 2" and Inside 3" Schedule 40 DWV Pipe



MADE IN THE USA

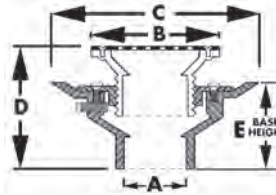

- 8-1/2" pan for applications where no clamping ring is required
- Strainers are available in SS, PB, NB and CP
- Spud threads directly into base
- Primer tapped with 1/2" plug
- Gray PVC / Black ABS
- Completely adjustable

	A	B	C	D	E
Without ring (SS str.)	Over 2" Inside 3"	6-1/8"	8-9/16"	4-15/16" – 5-7/8"	3-3/4"
Without ring	Over 2" Inside 3"	6-1/8"	8-9/16"	5" – 6"	3-3/4"
With ring	Over 2" Inside 3"	6-7/16"	8-9/16"	5-1/8" – 6-1/8"	3-3/4"

PART NO.	STRAINER	MATERIAL	CTN QTY
D49301	6" SS	PVC	1
D49302	6" SS	ABS	1
D49303	6" PB	PVC	1
D49304	6" PB	ABS	1
D49305	6" PB with ring	PVC	1
D49306	6" PB with ring	ABS	1
D49307	6" NB	PVC	1
D49308	6" NB	ABS	1
D49309	6" NB with ring	PVC	1
D49310	6" NB with ring	ABS	1
D49311	6" CP	PVC	1
D49312	6" CP	ABS	1
D49313	6" CP with ring	PVC	1
D49314	6" CP with ring	ABS	1

2" x 3" Heavy Duty Slab Drain Base with 3" Metal Spuds

5" Round Strainer

Fits Over 2" and Inside 3" Schedule 40 DWV Pipe

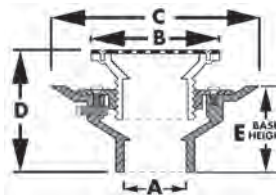

- 8-1/2" pan for applications where no clamping ring is required
- Strainers are available in PB and NB
- Spud threads directly into base
- Primer tapped with 1/2" plug
- Gray PVC / Black ABS
- Completely adjustable

	A	B	C	D	E
Metal	Over 2" Inside 3"	5-3/16"	8-9/16"	3-15/16" – 4-15/16"	3-3/4"

PART NO.	STRAINER	MATERIAL	CTN QTY
D49319	5" PB	PVC	1
D49320	5" PB	ABS	1
D49321	5" NB	PVC	1
D49322	5" NB	ABS	1

2" x 3" Heavy Duty Slab Drain Base with 3-1/2" Plastic Spuds

5" Round Strainer

Fits Over 2" and Inside 3" Schedule 40 DWV Pipe



MADE IN THE
USA

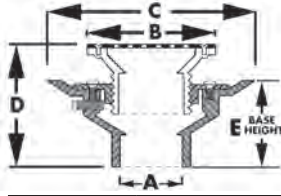

- 8-1/2" pan for applications where no clamping ring is required
- Strainers are available in SS, PB, NB and CP
- Spud threads directly into base
- Primer tapped with 1/2" plug
- Gray PVC / Black ABS
- Completely adjustable

	A	B	C	D	E
Without ring (SS str.)	Over 2" Inside 3"	5-1/4"	8-9/16"	4-3/4" — 6-1/16"	3-3/4"
Without ring	Over 2" Inside 3"	5-1/4"	8-9/16"	5" — 5-15/16"	3-3/4"
With ring	Over 2" Inside 3"	5-9/16"	8-9/16"	5-1/8" — 6-1/8"	3-3/4"

PART NO.	STRAINER	MATERIAL	CTN QTY
D49323	5" SS	PVC	1
D49324	5" SS	ABS	1
D49325	5" PB	PVC	1
D49326	5" PB	ABS	1
D49327	5" PB with ring	PVC	1
D49328	5" PB with ring	ABS	1
D49329	5" NB	PVC	1
D49330	5" NB	ABS	1
D49331	5" NB with ring	PVC	1
D49332	5" NB with ring	ABS	1
D49333	5" CP	PVC	1
D49334	5" CP	ABS	1
D49335	5" CP with ring	PVC	1
D49336	5" CP with ring	ABS	1

2" x 3" Heavy Duty Slab Drain Base with 3-1/2" Plastic Spuds

6" Round Strainer

Fits Over 2" and Inside 3" Schedule 40 DWV Pipe



MADE IN THE
USA

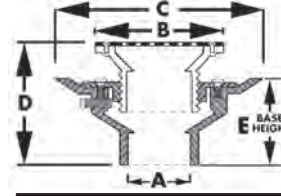

- 8-1/2" pan for applications where no clamping ring is required
- Strainers are available in SS, PB, NB and CP
- Spud threads directly into base
- Primer tapped with 1/2" plug
- Gray PVC / Black ABS
- Completely adjustable

	A	B	C	D	E
Without ring (SS str.)	Over 2" Inside 3"	6-1/4"	8-9/16"	5" — 6-1/16"	3-3/4"
Without ring	Over 2" Inside 3"	6-1/4"	8-9/16"	5-1/8" — 6"	3-3/4"
With ring	Over 2" Inside 3"	6-9/16"	8-9/16"	5-1/4" — 6-1/4"	3-3/4"

PART NO.	STRAINER	MATERIAL	CTN QTY
D49337	6" SS	PVC	1
D49338	6" SS	ABS	1
D49339	6" PB	PVC	1
D49340	6" PB	ABS	1
D49341	6" PB with ring	PVC	1
D49342	6" PB with ring	ABS	1
D49343	6" NB	PVC	1
D49344	6" NB	ABS	1
D49345	6" NB with ring	PVC	1
D49346	6" NB with ring	ABS	1
D49347	6" CP	PVC	1
D49348	6" CP	ABS	1
D49349	6" CP with ring	PVC	1
D49350	6" CP with ring	ABS	1

2" x 3" Heavy Duty Slab Drain Base with 3-1/2" Metal Spuds

4", 5" or 6" Round Strainer

Fits Over 2" and Inside 3" Schedule 40 DWV Pipe

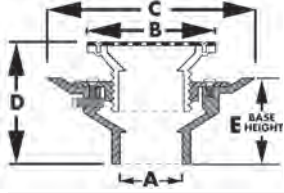

- 8-1/2" pan for applications where no clamping ring is required
- Strainers are available in PB, NB and CP
- Spud threads directly into base
- Primer tapped with 1/2" plug
- Gray PVC / Black ABS
- Completely adjustable

	A	B	C	D	E
4" without ring	Over 2" Inside 3"	4-1/8"	8-9/16"	48" - 4-15/16"	3-3/4"
5" without ring	Over 2" Inside 3"	5-3/16"	8-9/16"	4" - 5"	3-3/4"
6" without ring	Over 2" Inside 3"	6-3/16"	8-9/16"	4-7/16" - 5-1/2"	3-3/4"

PART NO.	STRAINER	MATERIAL	CTN QTY
D49351	4" PB	PVC	1
D49352	4" PB	ABS	1
D49353	4" NB	PVC	1
D49354	4" NB	ABS	1
D49355	5" PB	PVC	1
D49356	5" PB	ABS	1
D49357	5" NB	PVC	1
D49358	5" NB	ABS	1
D49359	5" CP	PVC	1
D49360	5" CP	ABS	1
D49361	6" PB	PVC	1
D49362	6" PB	ABS	1
D49363	6" NB	PVC	1
D49364	6" NB	ABS	1
D49365	6" CP	PVC	1
D49366	6" CP	ABS	1

2" x 3" Heavy Duty Slab Drain Base with 4" Plastic Spuds

6" Round Strainer

Fits Over 2" and Inside 3" Schedule 40 DWV Pipe



MADE IN THE USA

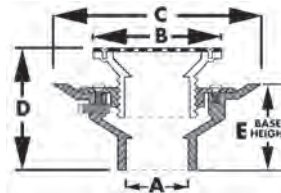

- 8-1/2" pan for applications where no clamping ring is required
- Strainers are available in SS, PB, NB and CP
- Spud threads directly into base
- Primer tapped with 1/2" plug
- Gray PVC / Black ABS
- Completely adjustable

	A	B	C	D	E
Without ring (SS str.)	Over 2" Inside 3"	6-3/16"	8-9/16"	5" - 5-15/16"	3-3/4"
Without ring	Over 2" Inside 3"	6-3/16"	8-9/16"	5" - 6"	3-3/4"
With ring	Over 2" Inside 3"	6-7/16"	8-9/16"	5-3/16" - 6-3/16"	3-3/4"

PART NO.	STRAINER	MATERIAL	CTN QTY
D49377	6" SS	PVC	1
D49378	6" SS	ABS	1
D49379	6" PB	PVC	1
D49380	6" PB	ABS	1
D49381	6" PB with ring	PVC	1
D49382	6" PB with ring	ABS	1
D49383	6" NB	PVC	1
D49384	6" NB	ABS	1
D49385	6" NB with ring	PVC	1
D49386	6" NB with ring	ABS	1
D49387	6" CP	PVC	1
D49388	6" CP	ABS	1
D49389	6" CP with ring	PVC	1
D49390	6" CP with ring	ABS	1

2" x 3" Heavy Duty Slab Drain Base with 4" Metal Spuds

5" Round Strainer

Fits Over 2" and Inside 3" Schedule 40 DWV Pipe

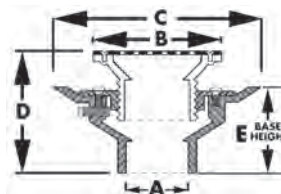

- 8-1/2" pan for applications where no clamping ring is required
- Strainers are available in PB and NB
- Spud threads directly into base
- Primer tapped with 1/2" plug
- Gray PVC / Black ABS
- Completely adjustable

	A	B	C	D	E
Metal	Over 2" Inside 3"	5-3/16"	8-9/16"	3-7/8" - 4-7/8"	3-3/4"

PART NO.	STRAINER	MATERIAL	CTN QTY
D49395	5" PB	PVC	1
D49396	5" PB	ABS	1
D49397	5" NB	PVC	1
D49398	5" NB	ABS	1

2" Heavy Duty Drain Base with 3-1/2" Plastic Spuds

5" Round Strainer

Fits Over 2" Schedule 40 DWV Pipe

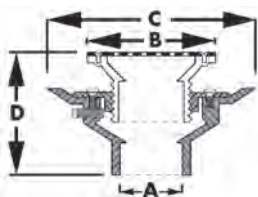

MADE IN THE USA

- 10" Pan
- Stainless steel strainers are .06" thick
- PB, NB and CP strainers are 3/16" thick
- Strainers are available in SS, PB, NB and CP
- Primer tapped with 1/2" plug

	A	B	C	D
Without ring	Over 2"	5-3/16"	11"	4-3/8" - 6"
With ring	Over 2"	5-1/2"	11"	4-1/2" - 6-1/8"

PART NO.	STRAINER	MATERIAL	CTN QTY
D53442	5" SS	PVC	1
D53449	5" SS	ABS	1
D53443	5" PB	PVC	1
D53450	5" PB	ABS	1
D53444	5" PB with ring	PVC	1
D53451	5" PB with ring	ABS	1
D53445	5" NB	PVC	1
D53452	5" NB	ABS	1
D53446	5" NB with ring	PVC	1
D53453	5" NB with ring	ABS	1
D53447	5" CP	PVC	1
D53454	5" CP	ABS	1
D53448	5" CP with ring	PVC	1
D53455	5" CP with ring	ABS	1

2" Heavy Duty Drain Base with 3-1/2" Metal Spuds

5" or 6" Round Strainer

Fits Over 2" Schedule 40 DWV Pipe

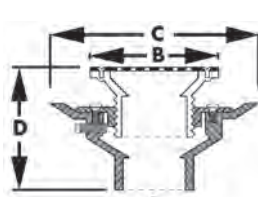

- 10" Pan
- PB, NB and CP strainers are 3/16" thick
- Strainers are available in PB, NB and CP
- Primer tapped with 1/2" plug
- Adjustable (see dimension D)

	A	B	C	D
Metal	Over 2"	5" or 6"	11"	4-1/4" - 5-5/8"

PART NO.	STRAINER	MATERIAL	CTN QTY
D50027	5" PB	PVC	1
D51027	5" PB	ABS	1
D50060	5" NB	PVC	1
D51060	5" NB	ABS	1
D50022	5" CP	PVC	1
D51022	5" CP	ABS	1
D50028	6" PB	PVC	1
D51028	6" PB	ABS	1
D50063	6" NB	PVC	1
D51063	6" NB	ABS	1
D50023	6" CP	PVC	1
D51023	6" CP	ABS	1

2" Heavy Duty Drain Base with 3-1/2" Plastic Spuds

6" Round Strainer

Fits Over 2" Schedule 40 DWV Pipe

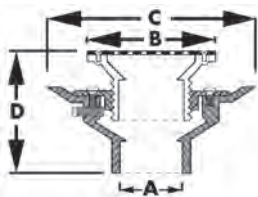

MADE IN THE USA

- 10" Pan
- Stainless steel strainers are .06" thick
- PB, NB and CP strainers are 3/16" thick
- Strainers are available in SS, PB, NB and CP
- Primer tapped with 1/2" plug

	A	B	C	D
Without ring	Over 2"	6-1/8"	11"	4-7/16" - 6-1/16"
With ring	Over 2"	6-1/2"	11"	4-1/2" - 6-1/4"

PART NO.	STRAINER	MATERIAL	CTN QTY
D50037	6" SS	PVC	1
D51037	6" SS	ABS	1
D50044	6" PB	PVC	1
D51044	6" PB	ABS	1
D50050	6" PB with ring	PVC	1
D51050	6" PB with ring	ABS	1
D50047	6" NB	PVC	1
D51047	6" NB	ABS	1
D50053	6" NB with ring	PVC	1
D51053	6" NB with ring	ABS	1
D50040	6" CP	PVC	1
D51040	6" CP	ABS	1
D50278	6" CP with ring	PVC	1
D51278	6" CP with ring	ABS	1

2" Heavy Duty Drain Base with 3-1/2" Metal Spuds

5" or 6" Square Strainer

Fits Over 2" Schedule 40 DWV Pipe

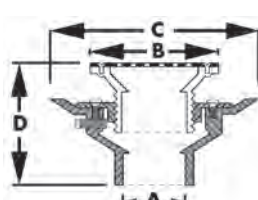

- 10" Pan
- Strainers are available in PB and NB
- PB and NB strainers are 3/16" thick
- Primer tapped with 1/2" plug

	A	B	C	D
Square top	Over 2"	5" or 6"	11"	4-1/4" - 5-5/8"

PART NO.	STRAINER	MATERIAL	CTN QTY
D50066	5" PB	PVC	1
D51066	5" PB	ABS	1
D50072	5" NB	PVC	1
D51072	5" NB	ABS	1
D50069	6" PB	PVC	1
D51069	6" PB	ABS	1
D50075	6" NB	PVC	1
D51075	6" NB	ABS	1

3" Heavy Duty Drain Base with 3-1/2" Plastic Spuds

5" Round Strainer

Fits Over 3" Schedule 40 DWV Pipe

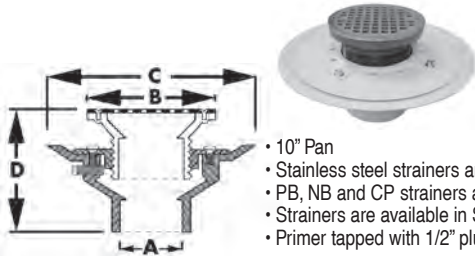

MADE IN THE USA

- 10" Pan
- Stainless steel strainers are .06" thick
- PB, NB and CP strainers are 3/16" thick
- Strainers are available in SS, PB, NB and CP
- Primer tapped with 1/2" plug

	A	B	C	D
Without ring	Over 3"	5-3/16"	11"	4-3/8" – 6"
With ring	Over 3"	5-1/2"	11"	4-1/2" – 6-1/8"

PART NO.	STRAINER	MATERIAL	CTN QTY
D53456	5" SS	PVC	1
D53463	5" SS	ABS	1
D53457	5" PB	PVC	1
D53464	5" PB	ABS	1
D53458	5" PB with ring	PVC	1
D53465	5" PB with ring	ABS	1
D53459	5" NB	PVC	1
D53466	5" NB	ABS	1
D53460	5" NB with ring	PVC	1
D53467	5" NB with ring	ABS	1
D53461	5" CP	PVC	1
D53468	5" CP	ABS	1
D53462	5" CP with ring	PVC	1
D53469	5" CP with ring	ABS	1

3" Heavy Duty Drain Base with 3-1/2" Plastic Spuds

6" Round Strainer

Fits Over 3" Schedule 40 DWV Pipe

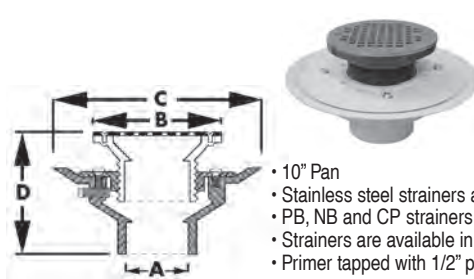

MADE IN THE USA

- 10" Pan
- Stainless steel strainers are .06" thick
- PB, NB and CP strainers are 3/16" thick
- Strainers are available in SS, PB, NB and CP
- Primer tapped with 1/2" plug

	A	B	C	D
Without ring	Over 3"	6-1/8"	11"	4-11/16" – 6-7/16"
With ring	Over 3"	6-1/2"	11"	4-3/4" – 6-1/2"

PART NO.	STRAINER	MATERIAL	CTN QTY
D50038	6" SS	PVC	1
D51038	6" SS	ABS	1
D50045	6" PB	PVC	1
D51045	6" PB	ABS	1
D50051	6" PB with ring	PVC	1
D51051	6" PB with ring	ABS	1
D50048	6" NB	PVC	1
D51048	6" NB	ABS	1
D50054	6" NB with ring	PVC	1
D51054	6" NB with ring	ABS	1
D50041	6" CP	PVC	1
D51041	6" CP	ABS	1
D50279	6" CP with ring	PVC	1
D51279	6" CP with ring	ABS	1

3" Heavy Duty Drain Base with 3-1/2" Metal Spuds

5", 6", 8" or 9" Round Strainer

Fits Over 3" Schedule 40 DWV Pipe

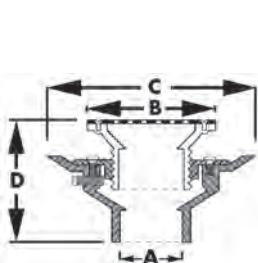

- 10" Pan
- Stainless steel strainers are .06" thick
- PB, NB and CP strainers are 3/16" thick
- Strainers are available in PB, NB and CP
- Primer tapped with 1/2" plug

	A	B	C	D
Metal	Over 3"	5", 6", 8" or 9"	11"	5" - 6-1/2"

PART NO.	STRAINER	MATERIAL	CTN QTY
D50012	5" PB	PVC	1
D51012	5" PB	ABS	1
D50061	5" NB	PVC	1
D51061	5" NB	ABS	1
D50004	5" CP	PVC	1
D51004	5" CP	ABS	1
D50013	6" PB	PVC	1
D51013	6" PB	ABS	1
D50064	6" NB	PVC	1
D51064	6" NB	ABS	1
D50005	6" CP	PVC	1
D51005	6" CP	ABS	1
D50014	8" PB	PVC	1
D51014	8" PB	ABS	1
D53144	8" NB	PVC	1
D53145	8" NB	ABS	1
D50006	8" CP	PVC	1
D51006	8" CP	ABS	1
D53148	9" PB	PVC	1
D53149	9" PB	ABS	1
D53146	9" NB	PVC	1
D53147	9" NB	ABS	1

3" Heavy Duty Drain Base with 3-1/2" Metal Spuds

5" or 6" Square Strainer

Fits Over 3" Schedule 40 DWV Pipe

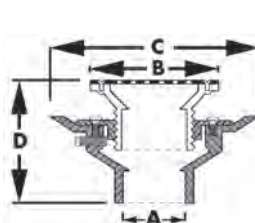

- 10" Pan
- Strainers are available in PB and NB
- PB and NB strainers are 3/16" thick
- Primer tapped with 1/2" plug

	A	B	C	D
Square top	Over 3"	5" or 6"	11"	5" - 6-1/2"

PART NO.	STRAINER	MATERIAL	CTN QTY
D50067	5" PB	PVC	1
D51067	5" PB	ABS	1
D50073	5" NB	PVC	1
D51073	5" NB	ABS	1
D50070	6" PB	PVC	1
D51070	6" PB	ABS	1
D50076	6" NB	PVC	1
D51076	6" NB	ABS	1

4" Heavy Duty Drain Base with 3-1/2" Plastic Spuds

5" Round Strainer

Fits Over 4" Schedule 40 DWV Pipe

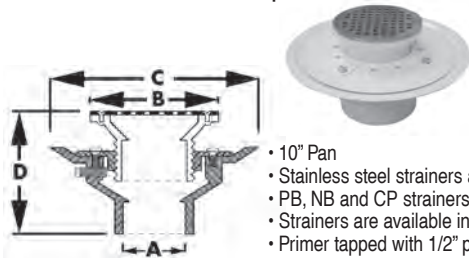

MADE IN THE USA

- 10" Pan
- Stainless steel strainers are .06" thick
- PB, NB and CP strainers are 3/16" thick
- Strainers are available in SS, PB, NB and CP
- Primer tapped with 1/2" plug

	A	B	C	D
Without ring	Over 4"	5-3/16"	11"	4-3/8" – 6"
With ring	Over 4"	5-1/2"	11"	4-1/2" – 6-1/8"

PART NO.	STRAINER	MATERIAL	CTN QTY
D53470	5" SS	PVC	1
D53477	5" SS	ABS	1
D53471	5" PB	PVC	1
D53478	5" PB	ABS	1
D53472	5" PB with ring	PVC	1
D53479	5" PB with ring	ABS	1
D53473	5" NB	PVC	1
D53480	5" NB	ABS	1
D53474	5" NB with ring	PVC	1
D53481	5" NB with ring	ABS	1
D53475	5" CP	PVC	1
D53482	5" CP	ABS	1
D53476	5" CP with ring	PVC	1
D53483	5" CP with ring	ABS	1

4" Heavy Duty Drain Base with 3-1/2" Plastic Spuds

6" Round Strainer

Fits Over 4" Schedule 40 DWV Pipe

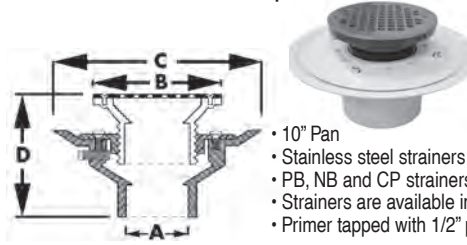

MADE IN THE USA

- 10" Pan
- Stainless steel strainers are .06" thick
- PB, NB and CP strainers are 3/16" thick
- Strainers are available in SS, PB, NB and CP
- Primer tapped with 1/2" plug

	A	B	C	D
Without ring	Over 4"	6-1/8"	11"	5-1/16" – 6-13/16"
With ring	Over 4"	6-1/2"	11"	5-1/4" – 6-15/16"

PART NO.	STRAINER	MATERIAL	CTN QTY
D50039	6" SS	PVC	1
D51039	6" SS	ABS	1
D50046	6" PB	PVC	1
D51046	6" PB	ABS	1
D50052	6" PB with ring	PVC	1
D51052	6" PB with ring	ABS	1
D50049	6" NB	PVC	1
D51049	6" NB	ABS	1
D50055	6" NB with ring	PVC	1
D51055	6" NB with ring	ABS	1
D50042	6" CP	PVC	1
D51042	6" CP	ABS	1
D50280	6" CP with ring	PVC	1
D51280	6" CP with ring	ABS	1

4" Heavy Duty Drain Base with 3-1/2" Metal Spuds

5" or 6" Round Strainer

Fits Over 4" Schedule 40 DWV Pipe

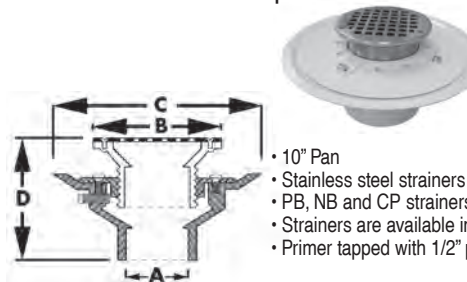

- 10" Pan
- Stainless steel strainers are .06" thick
- PB, NB and CP strainers are 3/16" thick
- Strainers are available in PB, NB and CP
- Primer tapped with 1/2" plug

	A	B	C	D
Metal	Over 4"	5" or 6"	11"	4-5/8" – 5-7/8"

PART NO.	STRAINER	MATERIAL	CTN QTY
D50062	5" NB	PVC	1
D51062	5" NB	ABS	1
D50015	5" PB	PVC	1
D51015	5" PB	ABS	1
D50007	5" CP	PVC	1
D51007	5" CP	ABS	1
D50065	6" NB	PVC	1
D51065	6" NB	ABS	1
D50016	6" PB	PVC	1
D51016	6" PB	ABS	1
D50008	6" CP	PVC	1
D51008	6" CP	ABS	1

4" Heavy Duty Drain Base with 3-1/2" Metal Spuds

5" or 6" Square Strainer

Fits Over 4" Schedule 40 DWV Pipe

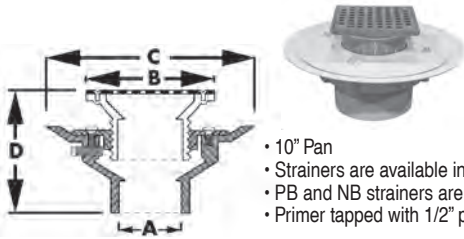

- 10" Pan
- Strainers are available in PB and NB
- PB and NB strainers are 3/16" thick
- Primer tapped with 1/2" plug

	A	B	C	D
Square top	Over 4"	5" or 6"	11"	4-5/8" – 5-7/8"

PART NO.	STRAINER	MATERIAL	CTN QTY
D50068	5" PB	PVC	1
D51068	5" PB	ABS	1
D50074	5" NB	PVC	1
D51074	5" NB	ABS	1
D50071	6" PB	PVC	1
D51071	6" PB	ABS	1
D50077	6" NB	PVC	1
D51077	6" NB	ABS	1

2" Heavy Duty Drain Base with 4" Plastic Spuds

6" Round Strainer

Fits Over 2" Schedule 40 DWV Pipe

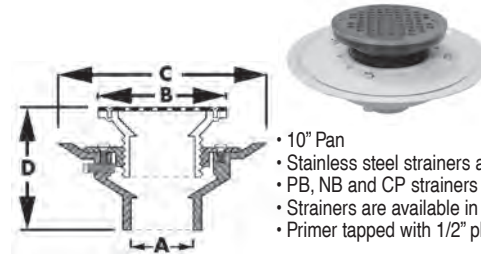

MADE IN THE
USA

- 10" Pan
- Stainless steel strainers are .06" thick
- PB, NB and CP strainers are 3/16" thick
- Strainers are available in SS, PB, NB and CP
- Primer tapped with 1/2" plug

	A	B	C	D
Without ring	Over 2"	6-1/8"	11"	4-7/16" – 6-1/16"
With ring	Over 2"	6-1/2"	11"	4-1/2" – 6-1/4"

PART NO.	STRAINER	MATERIAL	CTN QTY
D50340	6" SS	PVC	1
D51340	6" SS	ABS	1
D50341	6" PB	PVC	1
D51341	6" PB	ABS	1
D50342	6" PB with ring	PVC	1
D51342	6" PB with ring	ABS	1
D50343	6" NB	PVC	1
D51343	6" NB	ABS	1
D50344	6" NB with ring	PVC	1
D51344	6" NB with ring	ABS	1
D50345	6" CP	PVC	1
D51345	6" CP	ABS	1
D50346	6" CP with ring	PVC	1
D51346	6" CP with ring	ABS	1

2" Heavy Duty Drain Base with 4" Metal Spuds

5" Round Strainer

Fits Over 2" Schedule 40 DWV Pipe

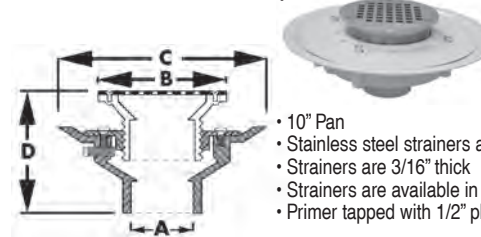

- 10" Pan
- Stainless steel strainers are .06" thick
- Strainers are 3/16" thick
- Strainers are available in PB and NB
- Primer tapped with 1/2" plug

	A	B	C	D
Metal	Over 2"	5"	11"	4-1/4" – 5-5/8"

PART NO.	STRAINER	MATERIAL	CTN QTY
D50349	5" NB	PVC	1
D51349	5" NB	ABS	1
D50350	5" PB	PVC	1
D51350	5" PB	ABS	1

3" Heavy Duty Drain Base with 4" Plastic Spuds

6" Round Strainer

Fits Over 3" Schedule 40 DWV Pipe



MADE IN THE USA

- 10" Pan
- Stainless steel strainers are .06" thick
- PB, NB and CP strainers are 3/16" thick
- Strainers are available in SS, PB, NB and CP
- Primer tapped with 1/2" plug

	A	B	C	D
Without ring	Over 3"	6-1/8"	4-5/8" – 6"	4-11/16" – 6-7/16"
With ring	Over 3"	6-1/2"	4-5/8" – 6"	4-3/4" – 6-1/2"

PART NO.	STRAINER	MATERIAL	CTN QTY
D50351	6" SS	PVC	1
D51351	6" SS	ABS	1
D50352	6" PB	PVC	1
D51352	6" PB	ABS	1
D50353	6" PB with ring	PVC	1
D51353	6" PB with ring	ABS	1
D50354	6" NB	PVC	1
D51354	6" NB	ABS	1
D50355	6" NB with ring	PVC	1
D51355	6" NB with ring	ABS	1
D50356	6" CP	PVC	1
D51356	6" CP	ABS	1
D50357	6" CP with ring	PVC	1
D51357	6" CP with ring	ABS	1

4" Heavy Duty Drain Base with 4" Plastic Spuds

6" Round Strainer

Fits Over 4" Schedule 40 DWV Pipe



MADE IN THE USA

- 10" Pan
- Stainless steel strainers are .06" thick
- PB, NB and CP strainers are 3/16" thick
- Strainers are available in SS, PB, NB and CP
- Primer tapped with 1/2" plug

	A	B	C	D
Without ring	Over 4"	6-1/8"	11"	5-1/16" – 6-13/16"
With ring	Over 4"	6-1/2"	11"	5-1/4" – 6-15/16"

PART NO.	STRAINER	MATERIAL	CTN QTY
D50362	6" SS	PVC	1
D51362	6" SS	ABS	1
D50363	6" PB	PVC	1
D51363	6" PB	ABS	1
D50364	6" PB with ring	PVC	1
D51364	6" PB with ring	ABS	1
D50365	6" NB	PVC	1
D51365	6" NB	ABS	1
D50366	6" NB with ring	PVC	1
D51366	6" NB with ring	ABS	1
D50367	6" CP	PVC	1
D51367	6" CP	ABS	1
D50368	6" CP with ring	PVC	1
D51368	6" CP with ring	ABS	1

3" Heavy Duty Drain Base with 4" Metal Spuds

5" Round Strainer

Fits Over 3" Schedule 40 DWV Pipe



- 10" Pan
- Strainers are 3/16" thick
- Strainers are available in PB and NB
- Primer tapped with 1/2" plug
- Adjustable (see dimension D)

	A	B	C	D
Metal	Over 3"	5"	4-5/8" – 6"	5" – 6-1/2"

PART NO.	STRAINER	MATERIAL	CTN QTY
D50361	5" PB	PVC	1
D51361	5" PB	ABS	1
D50360	5" NB	PVC	1
D51360	5" NB	ABS	1

4" Heavy Duty Drain Base with 4" Metal Spuds

5" Round Strainer

Fits Over 4" Schedule 40 DWV Pipe



- 10" Pan
- Strainers are 3/16" thick
- Strainers are available in PB and NB
- Primer tapped with 1/2" plug
- Adjustable (see dimension D)

	A	B	C	D
Metal	Over 4"	5"	11"	4-5/8" – 5-7/8"

PART NO.	STRAINER	MATERIAL	CTN QTY
D50372	5" PB	PVC	1
D51372	5" PB	ABS	1
D50371	5" NB	PVC	1
D51371	5" NB	ABS	1

Internal Pipe Cleanout

Solvent Welds Into Schedule 40 DWV Pipe



MADE IN THE
USA

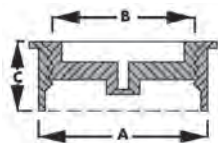

- Allows pipe to be cut flush with floor or wall
- Countersunk plug included

A	B	C
Inside 2"	1-1/2"	1"
Inside 3"	2-1/2"	1-1/8"
Inside 4"	3-1/2"	1-1/4"

PART NO.	PIPE SIZE	PLUG SIZE	OD	MATERIAL	CTN QTY
C60106	2"	1-1/2" IPS	1-7/8"	PVC	10
C60107	2"	1-1/2" IPS	1-7/8"	ABS	10
C60007	3"	2-1/2" IPS	2-13/16"	PVC	10
C60011	3"	2-1/2" IPS	2-13/16"	ABS	10
C60008	4"	3-1/2" IPS	4"	PVC	50
C60012	4"	3-1/2" IPS	4"	ABS	10
C60116	2"	1-1/2" with insert	—	PVC	10
C60117	3"	2-1/2" with insert	—	PVC	10
C60118	4"	3-1/2" with insert	—	PVC	10

Heavy Duty Internal Pipe Cleanout

Solvent Welds Into Schedule 40 DWV Pipe



MADE IN THE
USA

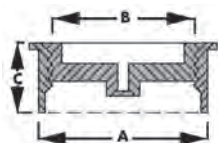

- Allows pipe to be cut flush with floor or wall
- Countersunk plug included

A	B	C
Inside 3"	2-1/4"	1-7/8"
Inside 4"	3-1/2"	2"

PART NO.	SIZE	PLUG SIZE	MATERIAL	CTN QTY
C60207	3"	2" IPS	PVC	10
C60211	3"	2" IPS	ABS	10
C60108	4"	3" IPS	PVC	10
C60112	4"	3" IPS	ABS	10

Hub/Fitting Cleanouts

Fits Inside 4" Schedule 40 DWV Fittings



MADE IN THE
USA

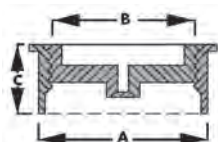

- 3-1/2" IPS countersunk plug
- Solvent welds into 4" fitting hubs

A	B	C
4-1/2"	3-7/8"	2-3/16"

PART NO.	DESCRIPTION	MATERIAL	CTN QTY
C60009	4"	PVC	10
C60010	4"	ABS	10

Fit-Flush Cleanout

2" x 3" Fits Over 2" or Inside 3" Schedule 40 DWV Pipe
3" x 4" Fits Over 3" or Inside 4" Schedule 40 DWV Pipe

MADE IN THE
USA

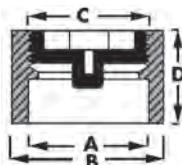

- Built-in stop
- Fits flush everytime

A	B	C	D
Over 2"	Inside 3"	2"	2"
Over 3"	Inside 4"	3"	2-1/2"

PART NO.	SIZE	PLUG SIZE	OD	MATERIAL	CTN QTY
C61023	2" x 3"	2" IPS	2-3/8"	PVC	1
C61123	2" x 3"	2" IPS	2-3/8"	ABS	1
C61034	3" x 4"	3" IPS	3-1/2"	PVC	1
C61134	3" x 4"	3" IPS	3-1/2"	ABS	1
C61223	2" x 3"	2" IPS brass	2-3/8"	PVC	1
C61234	3" x 4"	3" IPS brass	3-1/2"	PVC	1
C61432	2" x 3"	2" with insert	2-3/8"	PVC	1
C61434	3" x 4"	3" with insert	3-1/2"	PVC	1

Countersunk Cleanout Plugs w/Insert



- White plastic
- With threaded brass insert for cleanout covers

MADE IN THE
USA

PART NO.	DESCRIPTION	CTN QTY
P49915	1-1/2"	5
P49920	2"	5
P49925	2-1/2"	5
P49930	3"	5
P49935	3-1/2"	5
P49940	4"	5

Raised Head Cleanout Plugs



- White plastic

MADE IN THE
USA

PART NO.	DESCRIPTION	CTN QTY
P49150	1-1/2"	50
P49200	2"	50
P49250	2-1/2"	25
P49300	3"	25
P49350	3-1/2"	25
P49400	4"	30
P49600	6"	10

Countersunk Cleanout Plugs



- White plastic

PART NO.	DESCRIPTION	CTN QTY
P49015	1-1/2"	25
P49002	2"	25
P49025	2-1/2"	25
P49003	3"	25
P49035	3-1/2"	25
P49004	4"	25

4" PVC Hub Fit Cleanout with 3-1/2" Countersunk Brass Plug



- Fits flush
- Fits inside 4" hub or Schedule 40 DWV fitting

PART NO.	DESCRIPTION	CTN QTY
C61009	4" PVC hub fit cleanout	10

Adjustable Urinal Flange Kits

Socket Fits Over 2" Schedule 40 DWV Pipe
Spigot Fits Inside Hub of Fitting

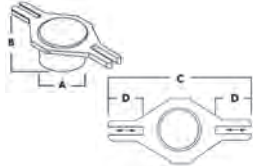

- 3-1/4" - 7" flange mounting centers
- Kits include bolts, nuts, washers and gasket

	A	B	C	D
Spigot	2-3/8"	1-13/16"	7"	1-11/16"
Socket/Hub	2-11/16"	1-1/2"	7"	1-11/16"

PART NO.	DESCRIPTION	MATERIAL	CTN QTY
F10001	Spigot outlet	PVC	20
F11001	Spigot outlet	ABS	20
F10002	Socket/hub outlet	PVC	20
F11002	Socket/hub outlet	ABS	20

Radial Fit Urinal Flange Kits



- Permits parallel alignment using radial slots
- Adjusts to 4" to 6" centers
- Socket and spigot connections
- Kit includes bolts, nuts, washers and gasket

PART NO.	DESCRIPTION	MATERIAL	CTN QTY
F10003	2" with socket connection	PVC	1
F11003	2" with socket connection	ABS	1
F10004	2" with spigot connection	PVC	1
F11004	2" with spigot connection	ABS	1

General Purpose Cleanouts

3" x 4" Fits Over 3" or Inside 4" Schedule 40 DWV Pipe
4" Fits Over 4" Schedule 40 DWV Pipe

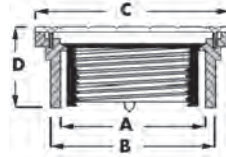

- Supplied with T Cone Test Plug installed

A	B	C	D
Over 3"	Inside 4"	5-3/16"	2-1/2"
Over 4"	—	6-1/8"	2-1/2"

PART NO.	DESCRIPTION	MATERIAL	CTN QTY
C60162	3" x 4" w/NB cover	PVC	5
C60163	3" x 4" w/NB cover	ABS	5
C60165	3" x 4" w/NB cover & ring	PVC	5
C60167	3" x 4" w/NB cover & ring	ABS	5
C60160	3" x 4" w/PB cover	PVC	5
C60161	3" x 4" w/PB cover	ABS	5
C60164	3" x 4" w/PB cover & ring	PVC	5
C60166	3" x 4" w/PB cover & ring	ABS	5
C60142	4" w/NB cover	PVC	5
C60143	4" w/NB cover	ABS	5
C60146	4" w/NB cover & ring	PVC	5
C60147	4" w/NB cover & ring	ABS	5
C60140	4" w/PB cover	PVC	5
C60141	4" w/PB cover	ABS	5
C60144	4" w/PB cover & ring	PVC	5
C60145	4" w/PB cover & ring	ABS	5

General Purpose Access Fittings

3" x 4" Fits Over 3" or Inside 4" Schedule 40 DWV Pipe
4" Fits Over 4" Schedule 40 DWV Pipe

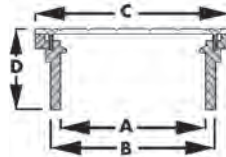

- For use with internal pipe cleanout, order separately

A	B	C	D
Over 3"	Inside 4"	5-3/16"	2-1/2"
Over 4"	—	6-1/8"	2-1/2"

PART NO.	DESCRIPTION	MATERIAL	CTN QTY
C60062	3" x 4" w/NB cover		5
C60063	3" x 4" w/NB cover		5
C60065	3" x 4" w/NB cover & ring		5
C60067	3" x 4" w/NB cover & ring		5
C60060	3" x 4" w/PB cover		5
C60061	3" x 4" w/PB cover		5
C60064	3" x 4" w/PB cover & ring		5
C60066	3" x 4" w/PB cover & ring		5
C60042	4" w/NB cover		5
C60043	4" w/NB cover		5
C60046	4" w/NB cover & ring		5
C60047	4" w/NB cover & ring		5
C60040	4" w/PB cover		5
C60041	4" w/PB cover		5
C60044	4" w/PB cover & ring		5
C60045	4" w/PB cover & ring		5

Inside Pipe Fit Cleanout with Cover

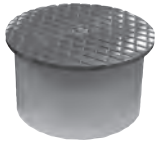

- Installed after concrete is poured
- No mess with protective tape
- Save time with installation
- Cut pipe 3/8" below grade with inside pipe cutter. Glue directly into pipe for finished look.

PART NO.	DESCRIPTION	CTN QTY
C60170	Inside 4" with NB cover	1
C60171	Inside 4" with CI cover	1
C60172	Inside 3" with NB cover	1

PVC Internal Cleanout w/SS Cover



PART NO.	DESCRIPTION	CTN QTY
C60015	3" w/5" SS external wall cover	1
C60016	4" w/6" SS external wall cover	1

Snap-in Access Fittings

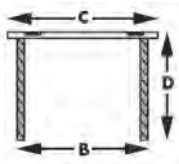

A	B	C	D
3"	3-1/16"	3-1/2"	2"
4"	4"	4-1/2"	2"

PART NO.	DESCRIPTION	MATERIAL	CTN QTY
C60013	3" with SS strainer	PVC	20
C60014	4" with SS strainer	PVC	20

Saddle Tees and Kits



- Use bushing to reduce 2" unit to 1-1/2"
- Kits include V-bolts, nuts and washers
- Conversion kit also contains gasket mat for use with cast iron pipe
- Solvent branch

PART NO.	DESCRIPTION	CTN QTY
S26014	3" x 2" Saddle tee only	20
S26015	4" x 2" Saddle tee only	10
S26016	4" x 3" Saddle tee only	10
S26017	4" x 4" Saddle tee only	10
S26004	3" x 2" Saddle tee kit less gasket	20
S26005	4" x 2" Saddle tee kit less gasket	10
S26006	4" x 3" Saddle tee kit less gasket	10
S26007	4" x 4" Saddle tee kit less gasket	10
S26009	3" x 2" Saddle tee conversion kit with gasket	20
S26010	4" x 2" Saddle tee conversion kit with gasket	10
S26011	4" x 3" Saddle tee conversion kit with gasket	10
S26012	4" x 4" Saddle tee conversion kit with gasket	10
S26008	6" x 7" x 1/4" closed cell foam gasket	20

Sewer Relief Plugs



- High-density construction
- Eliminates costly damages caused by sewer back-up
- Spring-loaded to close automatically to eliminate sewer gas
- Made of ABS

PART NO.	DESCRIPTION	CTN QTY
S25150	1-1/2"	10
S25200	2"	10
S25250	2-1/2"	10
S25300	3"	10
S25350	3-1/2"	10
S25400	4"	10

Test Tee w/Plug



- Easy pop top test
- PVC Plug included
- Test up to 3 floors

PART NO.	DESCRIPTION	CTN QTY
C67450	2"	1
C67451	3"	1

Round Covers w/2" Plastic Spuds



• Supplied with 2"IPS / 2-1/2" OD countersunk t-cone test plug



PART NO.	IPS	COVER	MATERIAL	CTN QTY
D59920	2"	4" PB	PVC	1
D59924	2"	4" PB	ABS	1
D59921	2"	4" PB with ring	PVC	1
D59925	2"	4" PB with ring	ABS	1
D59922	2"	4" NB	PVC	1
D59926	2"	4" NB	ABS	1
D59923	2"	4" NB with ring	PVC	1
D59927	2"	4" NB with ring	ABS	1

Round Covers w/3" Plastic Spuds



• Supplied with 2-1/2" IPS / 3" OD countersunk plug



PART NO.	IPS	COVER	MATERIAL	CTN QTY
D59904	3"	6" PB	PVC	1
D57904	3"	6" PB	ABS	1
D59908	3"	6" PB with ring	PVC	1
D57908	3"	6" PB with ring	ABS	1
D59905	3"	6" NB	PVC	1
D57905	3"	6" NB	ABS	1
D59909	3"	6" NB with ring	PVC	1
D57909	3"	6" NB with ring	ABS	1

Round Covers w/3" Metal Spuds



• Supplied with 2-1/2" IPS / 3" OD countersunk plug



PART NO.	IPS	COVER	CTN QTY
C37801	3"	5" PB	1
C37803	3"	5" NB	1
C37800	3"	5" CP	1

Round Covers w/3-1/2" Plastic Spuds



• Supplied with 3" IPS countersunk plug



PART NO.	IPS	COVER	MATERIAL	CTN QTY
D59943	3-1/2"	5" PB	PVC	1
D59947	3-1/2"	5" PB	ABS	1
D59944	3-1/2"	5" PB with ring	PVC	1
D59948	3-1/2"	5" PB with ring	ABS	1
D59945	3-1/2"	5" NB	PVC	1
D59949	3-1/2"	5" NB	ABS	1
D59946	3-1/2"	5" NB with ring	PVC	1
D59950	3-1/2"	5" NB with ring	ABS	1
D59901	3-1/2"	6" PB	PVC	1
D57901	3-1/2"	6" PB	ABS	1
D59906	3-1/2"	6" PB with ring	PVC	1
D57906	3-1/2"	6" PB with ring	ABS	1
D59902	3-1/2"	6" NB	PVC	1
D57902	3-1/2"	6" NB	ABS	1
D59907	3-1/2"	6" NB with ring	PVC	1
D57907	3-1/2"	6" NB with ring	ABS	1

Round Covers w/4" Plastic Spuds



• Supplied with 3" IPS countersunk plug



PART NO.	IPS	COVER	MATERIAL	CTN QTY
D59914	4"	6" PB	PVC	1
D57914	4"	6" PB	ABS	1
D59915	4"	6" PB with ring	PVC	1
D57915	4"	6" PB with ring	ABS	1
D59916	4"	6" NB	PVC	1
D57916	4"	6" NB	ABS	1
D59917	4"	6" NB with ring	PVC	1
D57917	4"	6" NB with ring	ABS	1

Round Covers w/3-1/2" Metal Spuds



• Supplied with 3-1/2" IPS countersunk plug



PART NO.	IPS	COVER	CTN QTY
C37811	3-1/2"	5" PB	1
C37810	3-1/2"	5" NB	1

Round Covers w/4" Metal Spuds



• Supplied with 3-1/2" IPS countersunk plug



PART NO.	IPS	COVER	CTN QTY
C37806	4"	5" PB	1
C37805	4"	5" NB	1

Round Covers w/4" Metal Spuds



• Supplied with 4" IPS countersunk plug



PART NO.	IPS	COVER	CTN QTY
C37808	4"	6" PB	1
C37807	4"	6" NB	1

Square Covers w/3" Plastic Spuds



• Supplied with 2-1/2" IPS / 3" OD countersunk plug



PART NO.	IPS	COVER	MATERIAL	CTN QTY
D59912	3"	7" PB	PVC	1
D57912	3"	7" PB	ABS	1
D59913	3"	7" NB	PVC	1
D57913	3"	7" NB	ABS	1

Square Covers w/3-1/2" Plastic Spuds



• Supplied with 3" IPS countersunk plug



PART NO.	IPS	COVER	MATERIAL	CTN QTY
D59910	3-1/2"	7" PB	PVC	1
D57910	3-1/2"	7" PB	ABS	1
D59911	3-1/2"	7" NB	PVC	1
D57911	3-1/2"	7" NB	ABS	1

Square Covers w/4" Plastic Spuds



• Supplied with 3" IPS countersunk plug



PART NO.	IPS	COVER	MATERIAL	CTN QTY
D59918	4"	7" PB	PVC	1
D57918	4"	7" PB	ABS	1
D59919	4"	7" NB	PVC	1
D57919	4"	7" NB	ABS	1

4" Hub Fit Base with 3-1/2" Plastic Spuds

5" Round Cover

Fits Inside 4" Schedule 40 DWV Pipe

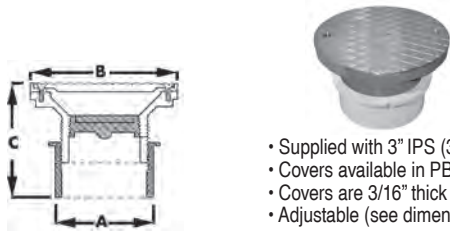

- Supplied with 3" IPS (3-1/2" OD) countersunk plug
- Covers available in PB and NB
- Covers are 3/16" thick
- Adjustable (see dimension C)

	A	B	C
Without ring	4" Hub fit	5-3/16"	3-1/8" – 4-5/8"
With ring	4" Hub fit	5-1/2"	3-5/16" – 4-13/16"

PART NO.	COVER	MATERIAL	CTN QTY
C59200	5" PB		1
C59204	5" PB		1
C59201	5" PB with ring		1
C59205	5" PB with ring		1
C59202	5" NB		1
C59206	5" NB		1
C59203	5" NB with ring		1
C59207	5" NB with ring		1

4" Hub Fit Base with 3-1/2" Plastic Spuds

6" Round Cover

Fits Inside 4" Schedule 40 DWV Pipe

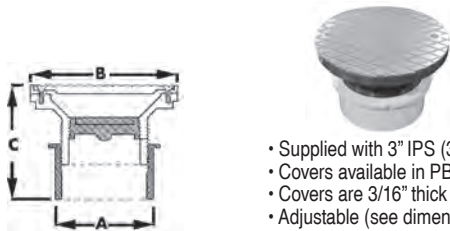

- Supplied with 3" IPS (3-1/2" OD) countersunk plug
- Covers available in PB and NB
- Covers are 3/16" thick
- Adjustable (see dimension C)

	A	B	C
Without ring	4" Hub fit	6-1/8"	3-1/8" – 4-5/8"
With ring	4" Hub fit	6-1/2"	3-5/16" – 4-13/16"

PART NO.	COVER	MATERIAL	CTN QTY
C59001	6" PB	PVC	1
C59002	6" PB	ABS	1
C59005	6" PB with ring	PVC	1
C59006	6" PB with ring	ABS	1
C59003	6" NB	PVC	1
C59004	6" NB	ABS	1
C59007	6" NB with ring	PVC	1
C59008	6" NB with ring	ABS	1

4" Hub Fit Base with 3-1/2" Plastic Spuds

7" Square Top

Fits Inside 4" Schedule 40 DWV Pipe

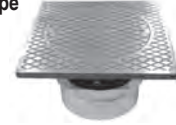
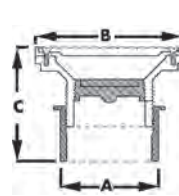

- Supplied with 3" IPS (3-1/2" OD) countersunk plug
- Covers available in PB and NB
- Covers are 3/16" thick
- Adjustable (see dimension C)

	A	B	C
Square	4" Hub fit	7"	3-3/8" – 4-15/16"

PART NO.	COVER	MATERIAL	CTN QTY
C59050	7" PB	PVC	1
C59051	7" PB	ABS	1
C59052	7" NB	PVC	1
C59053	7" NB	ABS	1

4" Hub Fit Base with 3-1/2" Metal Spuds

5" Round Cover

Fits Inside 4" Schedule 40 DWV Pipe

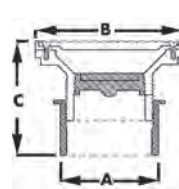

- Supplied with 3" IPS (3-1/2" OD) countersunk plug
- Covers available in PB and NB
- Covers are 3/16" thick
- Adjustable (see dimension C)

	A	B	C
Metal	4" Hub fit	5-3/16"	3-1/4" – 4-1/4"

PART NO.	COVER	MATERIAL	CTN QTY
C59060	5" PB	PVC	1
C59061	5" PB	ABS	1
C59062	5" NB	PVC	1
C59063	5" NB	ABS	1

3" x 4" Pipe Fit Base with 3-1/2" Plastic Spuds

5" Round Cover

Fits Over 3" or Inside 4" Schedule 40 DWV Pipe

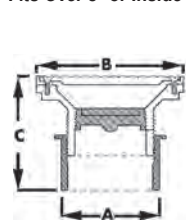

- Supplied with 3" IPS (3-1/2" OD) countersunk plug
- Covers available in PB and NB
- Covers are 3/16" thick
- Adjustable (see dimension D)

	A	B	C
Without ring	Over 3" Pipe Inside 4" Pipe	5-3/16"	3-1/8" - 4-5/8"
With ring	Over 3" Pipe Inside 4" Pipe	5-1/2"	3-5/16" - 4-13/16"

PART NO.	COVER	MATERIAL	CTN QTY
C59216	5" PB	PVC	1
C59220	5" PB	ABS	1
C59217	5" PB with ring	PVC	1
C59221	5" PB with ring	ABS	1
C59218	5" NB	PVC	1
C59222	5" NB	ABS	1
C59219	5" NB with ring	PVC	1
C59223	5" NB with ring	ABS	1

3" x 4" Pipe Fit Base with 3-1/2" Plastic Spuds

6" Round Cover

Fits Over 3" or Inside 4" Schedule 40 DWV Pipe

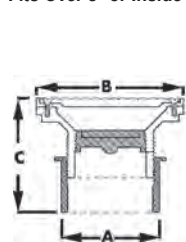

- Supplied with 3" IPS (3-1/2" OD) countersunk plug
- Covers available in PB and NB
- Covers are 3/16" thick
- Adjustable (see dimension D)

	A	B	C
Without ring	Over 3" Pipe Inside 4" Pipe	6-1/8"	3-1/8" - 4-5/8"
With ring	Over 3" Pipe Inside 4" Pipe	6-1/2"	3-5/16" - 4-13/16"

PART NO.	COVER	MATERIAL	CTN QTY
C59010	6" PB	PVC	1
C59011	6" PB	ABS	1
C59014	6" PB with ring	PVC	1
C59015	6" PB with ring	ABS	1
C59012	6" NB	PVC	1
C59013	6" NB	ABS	1
C59016	6" NB with ring	PVC	1
C59017	6" NB with ring	ABS	1

3" x 4" Pipe Fit Base with 3-1/2" Plastic Spuds

7" Square Top

Fits Over 3" or Inside 4" Schedule 40 DWV Pipe

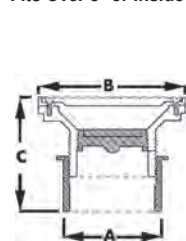

- Supplied with 3" IPS (3-1/2" OD) countersunk plug
- Covers available in PB and NB
- Covers are 3/16" thick
- Adjustable (see dimension D)

	A	B	C
Square	Over 3" Pipe Inside 4" Pipe	7"	5-15/16" - 7-1/2"

PART NO.	COVER	MATERIAL	CTN QTY
C59054	7" PB	PVC	1
C59055	7" PB	ABS	1
C59056	7" NB	PVC	1
C59057	7" NB	ABS	1

3" x 4" Pipe Fit Base with 3-1/2" Metal Spuds

5" Round Cover

Fits Over 3" or Inside 4" Schedule 40 DWV Pipe

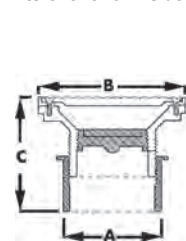

- Supplied with 3" IPS (3-1/2" OD) countersunk plug
- Covers available in PB and NB
- Covers are 3/16" thick
- Adjustable (see dimension D)

	A	B	C
Metal	Over 3" Pipe Inside 4" Pipe	5-3/16"	5-3/4" - 7"

PART NO.	COVER	MATERIAL	CTN QTY
C59068	5" PB	PVC	1
C59069	5" PB	ABS	1
C59070	5" NB	PVC	1
C59071	5" NB	ABS	1

4" Over Pipe Fit Base with 3-1/2" Plastic Spuds

5" Round Cover

Fits Over 4" Schedule 40 DWV Pipe

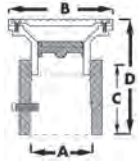

- Supplied with 3" IPS (3-1/2" OD) countersunk plug
- Covers available in PB and NB
- Covers are 3/16" thick
- Adjustable (see dimension D)

	A	B	C	D
Without ring	Over 4" Pipe	5-3/16"	4-1/4"	5-15/16" – 7-1/2"
With ring	Over 4" Pipe	5-1/2"	4-1/4"	6-1/16" – 7-5/8"

PART NO.	COVER	MATERIAL	CTN QTY
C59208	5" PB	PVC	1
C59212	5" PB	ABS	1
C59209	5" PB with ring	PVC	1
C59213	5" PB with ring	ABS	1
C59210	5" NB	PVC	1
C59214	5" NB	ABS	1
C59211	5" NB with ring	PVC	1
C59215	5" NB with ring	ABS	1

4" Over Pipe Fit Base with 3-1/2" Plastic Spuds

6" Round Cover

Fits Over 4" Schedule 40 DWV Pipe

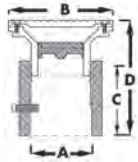

- Supplied with 3" IPS (3-1/2" OD) countersunk plug
- Covers available in PB and NB
- Covers are 3/16" thick
- Adjustable (see dimension D)

	A	B	C	D
Without ring	Over 4" Pipe	6-1/8"	4-1/4"	5-15/16" – 7-1/2"
With ring	Over 4" Pipe	6-1/2"	4-1/4"	6-1/16" – 7-5/8"

PART NO.	COVER	MATERIAL	CTN QTY
C60001	6" PB	PVC	1
C60003	6" PB	ABS	1
C60022	6" PB with ring	PVC	1
C60023	6" PB with ring	ABS	1
C60020	6" NB	PVC	1
C60021	6" NB	ABS	1
C60024	6" NB with ring	PVC	1
C60025	6" NB with ring	ABS	1

4" Over Pipe Fit Base with 3-1/2" Plastic Spuds

7" Square Cover

Fits Over 4" Schedule 40 DWV Pipe

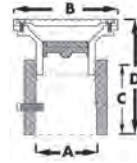

- Supplied with 3" IPS (3-1/2" OD) countersunk plug
- Covers available in PB and NB
- Covers are 3/16" thick
- Adjustable (see dimension D)

	A	B	C	D
Square	Over 4" Pipe	7"	4-1/4"	6-1/8" – 7-11/16"

PART NO.	COVER	MATERIAL	CTN QTY
C60050	7" PB	PVC	1
C60051	7" PB	ABS	1
C60052	7" NB	PVC	1
C60053	7" NB	ABS	1

4" Over Pipe Fit Base with 3-1/2" Metal Spuds

5" Round Cover

Fits Over 4" Schedule 40 DWV Pipe

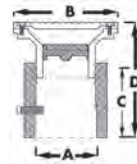

- Supplied with 3" IPS (3-1/2" OD) countersunk plug
- Covers available in PB and NB
- Covers are 3/16" thick
- Adjustable (see dimension D)

	A	B	C	D
Metal	Over 4" Pipe	5"	4-1/4"	6" – 7-1/16"

PART NO.	COVER	MATERIAL	CTN QTY
C59064	5" PB	PVC	1
C59065	5" PB	ABS	1
C59066	5" NB	PVC	1
C59067	5" NB	ABS	1

4" Over Pipe Fit Base with 4" Plastic Spuds

6" Round Cover

Fits Over 4" Schedule 40 DWV Pipe

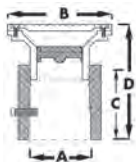

- Supplied with 3" IPS (3-1/2" OD) countersunk plug
- Covers available in PB and NB
- Covers are 3/16" thick
- Adjustable (see dimension D)

	A	B	C	D
Without ring	Over 4" Pipe	6"	4-3/4"	6-1/16" - 7-3/16"
With ring	Over 4" Pipe	6-1/8"	4-3/4"	6-1/8" - 7-1/4"

PART NO.	COVER	MATERIAL	CTN QTY
C60070	6" PB	PVC	1
C60076	6" PB	ABS	1
C60071	6" PB with ring	PVC	1
C60077	6" PB with ring	ABS	1
C60072	6" NB	PVC	1
C60078	6" NB	ABS	1
C60073	6" NB with ring	PVC	1
C60079	6" NB with ring	ABS	1

4" Over Pipe Fit Base with 4" Metal Spuds

5" or 6" Round Cover

Fits Over 4" Schedule 40 DWV Pipe

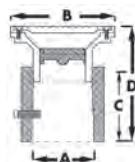

- 5" Supplied with 3" IPS (3-1/2" OD) countersunk plug
- 6" Supplied with 4" IPS plug
- Covers available in PB and NB
- Covers are 3/16" thick
- Adjustable (see dimension D)

	A	B	C	D
Metal	Over 4" Pipe	5"	4-3/4"	5" - 6"
Metal	Over 4" Pipe	6"	4-3/4"	5" - 6"

PART NO.	COVER	MATERIAL	CTN QTY
C60082	5" NB	PVC	1
C60083	5" NB	ABS	1
C60092	5" PB	PVC	1
C60094	6" NB	PVC	1
C60095	6" NB	ABS	1
C60096	6" PB	PVC	1
C60097	6" PB	ABS	1

4" Over Pipe Fit Base with 4" Plastic Spuds

7" Square Top

Fits Over 4" Schedule 40 DWV Pipe

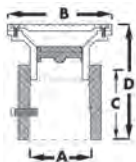

- Supplied with 3" IPS (3-1/2" OD) countersunk plug
- Covers available in PB and NB
- Covers are 3/16" thick
- Adjustable (see dimension D)

	A	B	C	D
Square	Over 4" Pipe	7"	4-3/4"	6-3/16" - 7-3/8"

PART NO.	COVER	MATERIAL	CTN QTY
C60074	7" PB	PVC	1
C60080	7" PB	ABS	1
C60075	7" NB	PVC	1
C60081	7" NB	ABS	1

3" Over Pipe Fit Base with 3" Plastic Spuds

6" Round Cover

Fits Over 3" Schedule 40 DWV Pipe

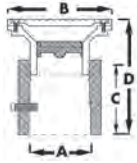

- Supplied with 2-1/2" IPS (3" OD) countersunk plug
- Covers are 3/16" thick
- Adjustable (see dimension D)

	A	B	C	D
Without ring	Over 3" Pipe	6-1/8"	4-1/2"	5-7/8" - 7-1/8"
With ring	Over 3" Pipe	6-1/2"	4-1/2"	6" - 7-3/16"

PART NO.	COVER	MATERIAL	CTN QTY
C60026	6" PB	PVC	1
C60027	6" PB	ABS	1
C60030	6" PB with ring	PVC	1
C60031	6" PB with ring	ABS	1
C60028	6" NB	PVC	1
C60029	6" NB	ABS	1
C60032	6" NB with ring	PVC	1
C60033	6" NB with ring	ABS	1

3" Over Pipe Fit Base with 3" Metal Spuds

5" Round Cover

Fits Over 3" Schedule 40 DWV Pipe

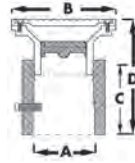

- Supplied with 2-1/2" IPS (3" OD) countersunk plug
- Covers are 3/16" thick
- Adjustable (see dimension D)

	A	B	C	D
Metal	Over 3" Pipe	5-3/16"	4-1/2"	5" - 6"

PART NO.	COVER	MATERIAL	CTN QTY
C60086	5" PB	PVC	1
C60087	5" PB	ABS	1
C60084	5" NB	PVC	1
C60085	5" NB	ABS	1
C60088	5" CP	PVC	1
C60089	5" CP	ABS	1

3" Over Pipe Fit Base with 3" Plastic Spuds

7" Square Top

Fits Over 3" Schedule 40 DWV Pipe

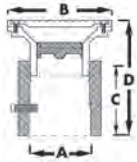

- Supplied with 2-1/2" IPS (3" OD) countersunk plug
- Covers are 3/16" thick
- Adjustable (see dimension D)

	A	B	C	D
Square	Over 3" Pipe	7"	4-1/2"	6" - 7-3/16"

PART NO.	COVER	MATERIAL	CTN QTY
C60054	7" PB	PVC	1
C60055	7" PB	ABS	1
C60056	7" NB	PVC	1
C60057	7" NB	ABS	1

4" Inside Pipe Fit Base with 3" Plastic Spuds

6" Round Cover

Fits Inside 4" Schedule 40 DWV Pipe

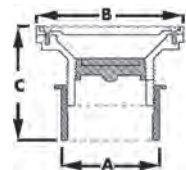

- Supplied with 3" IPS (3-1/2" OD) countersunk plug
- Covers available in PB and NB
- Covers are 3/16" thick
- Adjustable (see dimension D)

	A	B	C
Without ring	Inside 4" Pipe	6-1/8"	3-7/8" – 4-5/8"
With ring	Inside 4" Pipe	6-1/2"	4" – 4-3/4"

PART NO.	COVER	MATERIAL	CTN QTY
C59020	6" PB	PVC	1
C59021	6" PB	ABS	1
C59024	6" PB with ring	PVC	1
C59025	6" PB with ring	ABS	1
C59022	6" NB	PVC	1
C59023	6" NB	ABS	1
C59026	6" NB with ring	PVC	1
C59027	6" NB with ring	ABS	1

4" Inside Pipe Fit Base with 3" Metal Spuds

5" Round Cover

Fits Inside 4" Schedule 40 DWV Pipe

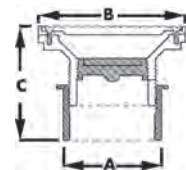

- Supplied with 3" IPS (3-1/2" OD) countersunk plug
- Covers available in PB, NB and CP
- Covers are 3/16" thick
- Adjustable (see dimension D)

	A	B	C
Metal	Inside 4" Pipe	5"	2-7/16" – 3-1/2"

PART NO.	COVER	MATERIAL	CTN QTY
C59090	5" NB	PVC	1
C59091	5" NB	ABS	1
C59092	5" PB	PVC	1
C59093	5" PB	ABS	1
C59094	5" CP	PVC	1
C59095	5" CP	ABS	1

4" Inside Pipe Fit Base with 3" Plastic Spuds

7" Square Top

Fits Inside 4" Schedule 40 DWV Pipe

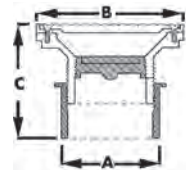

- Supplied with 3" IPS (3-1/2" OD) countersunk plug
- Covers available in PB and NB
- Covers are 3/16" thick
- Adjustable (see dimension D)

	A	B	C
Square	Inside 4" Pipe	7"	4" – 4-7/8"

PART NO.	COVER	MATERIAL	CTN QTY
C59028	7" PB	PVC	1
C59029	7" PB	ABS	1
C59030	7" NB	PVC	1
C59031	7" NB	ABS	1

2" x 3" Cleanouts w/2" Plastic Spud

4" Round Cover

Fits Over 2" or Inside 3" Schedule 40 DWV Pipe

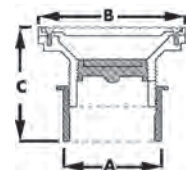

MADE IN THE USA

- Supplied with 2" t-cone test plug installed
- Covers available in PB and NB

	A	B	C
Without ring	2"	4-1/4"	2-1/4"
With ring	2"	4-1/2"	2-3/8"

PART NO.	COVER	MATERIAL	CTN QTY
C59096	4" PB	PVC	1
C59100	4" PB	ABS	1
C59097	4" PB with ring	PVC	1
C59101	4" PB with ring	ABS	1
C59098	4" NB	PVC	1
C59102	4" NB	ABS	1
C59099	4" NB with ring	PVC	1
C59103	4" NB with ring	ABS	1

Round Slop Sinks

Fits Over 3" or Inside 4" Pipe

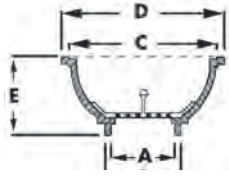

MADE IN THE
USA

- 4-7/8" OD scoop strainer with stem for easy removal
- 12" diameter

A	B	C	D	E
3"	4"	11"	12"	6-3/8"

PART NO.	DESCRIPTION	CTN QTY
S55001	3" x 4" PVC sink and strainer	1
S55002	Replacement strainer	1

Floor Sinks

To Be Used with Coupling or Hub Kit

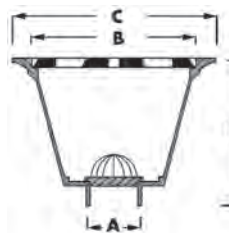

MADE IN THE
USA

- 3/4" thick top grate in three styles
- 12" x 12" top flange

A	B	C	D
Inside 2" fitting	9-3/16"	12"	8"
Inside 3" fitting	9-3/16"	12"	8"
Inside 4" fitting	9-3/16"	12"	8"

PART NO.	DESCRIPTION	MATERIAL	CTN QTY
S59002	2" sink only	PVC	1
S59302	2" sink only	ABS	1
S59003	3" sink only	PVC	1
S59303	3" sink only	ABS	1
S59004	4" sink only	PVC	1
S59304	4" sink only	ABS	1

Complete PVC Floor Sink Kits

MADE IN THE
USA



- Includes sink, top grate and bottom strainer

PART NO.	DESCRIPTION	CTN QTY
S49042	2" – 1/2 top grate – dome bottom grate	1
S49052	2" – 3/4 top grate – dome bottom grate	1
S49062	2" – full top grate – dome bottom grate	1
S49072	2" – 1/2 top grate – flat bottom grate	1
S49082	2" – 3/4 top grate – flat bottom grate	1
S49092	2" – full top grate – flat bottom grate	1
S49043	3" – 1/2 top grate – dome bottom grate	1
S49053	3" – 3/4 top grate – dome bottom grate	1
S49063	3" – full top grate – dome bottom grate	1
S49073	3" – 1/2 top grate – flat bottom grate	1
S49083	3" – 3/4 top grate – flat bottom grate	1
S49093	3" – full top grate – flat bottom grate	1
S49044	4" – 1/2 top grate – dome bottom grate	1
S49054	4" – 3/4 top grate – dome bottom grate	1
S49064	4" – full top grate – dome bottom grate	1
S49074	4" – 1/2 top grate – flat bottom grate	1
S49084	4" – 3/4 top grate – flat bottom grate	1
S49094	4" – full top grate – flat bottom grate	1

Floor Sinks

2" x 3" Fits Over 2" or Inside 3" Schedule 40 DWV Pipe
3" x 4" Fits Over 3" or Inside 4" Schedule 40 DWV Pipe
4" Fits Over 4" Schedule 40 DWV Pipe

MADE IN THE
USA

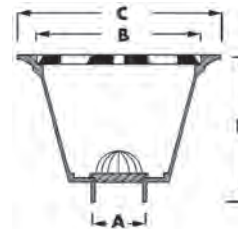

- 3/4" thick top grate in three styles
- 12" x 12" top flange
- Temp up to 180°

A	B	C	D
Over 2" Inside 3"	9-3/16"	12"	8"
Over 3" Inside 4"	9-3/16"	12"	8"
Over 4"	9-3/16"	12"	8"

PART NO.	DESCRIPTION	MATERIAL	CTN QTY
S59102	2" x 3" sink only	PVC	1
S59402	2" x 3" sink only	ABS	1
S59103	3" x 4" sink only	PVC	1
S59403	3" x 4" sink only	ABS	1
S59104	4" sink only	PVC	1

Complete PVC Floor Sink Kits-Pipe Fit



• Includes sink, top grate and bottom strainer

PART NO.	DESCRIPTION	CTN QTY
S59042	2" x 3" – 1/2 top grate – dome bottom grate	1
S59052	2" x 3" – 3/4 top grate – dome bottom grate	1
S59062	2" x 3" – full top grate – dome bottom grate	1
S59072	2" x 3" – 1/2 top grate – flat bottom grate	1
S59082	2" x 3" – 3/4 top grate – flat bottom grate	1
S59092	2" x 3" – full top grate – flat bottom grate	1
S59043	3" x 4" – 1/2 top grate – dome bottom grate	1
S59053	3" x 4" – 3/4 top grate – dome bottom grate	1
S59063	3" x 4" – full top grate – dome bottom grate	1
S59073	3" x 4" – 1/2 top grate – flat bottom grate	1
S59083	3" x 4" – 3/4 top grate – flat bottom grate	1
S59093	3" x 4" – full top grate – flat bottom grate	1
S59044	4" – 1/2 top grate – dome bottom grate	1
S59054	4" – 3/4 top grate – dome bottom grate	1
S59064	4" – full top grate – dome bottom grate	1
S59074	4" – 1/2 top grate – flat bottom grate	1
S59084	4" – 3/4 top grate – flat bottom grate	1
S59094	4" – full top grate – flat bottom grate	1

Half Top Grate for Floor Sinks



• Accessories for all S49 and S59 series floor sinks

PART NO.	DESCRIPTION	MATERIAL	CTN QTY
S59012	1/2 top grate	PVC	10
S59312	1/2 top grate	ABS	10

Aluminum Dome Strainers for Floor Sinks



• Accessories for all S49 and S59 series floor sinks

PART NO.	DESCRIPTION	CTN QTY
S60002	2" aluminum dome bottom strainer	10
S60003	3" aluminum dome bottom strainer	10
S60004	4" aluminum dome bottom strainer	10

Full Top Grate for Floor Sinks



• Accessories for all S49 and S59 series floor sinks

PART NO.	DESCRIPTION	MATERIAL	CTN QTY
S59010	Full top grate	PVC	10
S59310	Full top grate	ABS	10

Flat Aluminum Bottom Strainer for Floor Sinks



• Accessories for all S49 and S59 series floor sinks

PART NO.	DESCRIPTION	CTN QTY
S60005	flat aluminum bottom strainer	10

Three-Quarters Top Grate for Floor Sinks



• Accessories for all S49 and S59 series floor sinks

PART NO.	DESCRIPTION	MATERIAL	CTN QTY
S59011	3/4 top grate	PVC	10
S59311	3/4 top grate	ABS	10

Roof Drains w/Cast Iron Dome

Fits over Schedule 40 DWV Pipe



MADE IN THE
USA

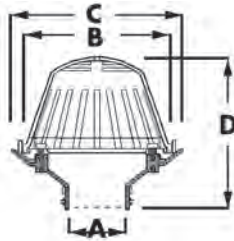

- Brass inserts in underside for underdeck clamps
- Dome has 50 square inches of free area

	A	B	C	D
Over 2" pipe		8-1/4"	11"	9"
Over 3" pipe		8-1/4"	11"	9"
Over 4" pipe		8-1/4"	11"	9"
Over 6" pipe		8-1/4"	11"	8"

PART NO.	DESCRIPTION	MATERIAL	CTN	QTY
R18001	2" cast iron dome	PVC		1
R18009	2" cast iron dome	ABS		1
R18005	3" cast iron dome	PVC		1
R18007	3" cast iron dome	ABS		1
R18006	4" cast iron dome	PVC		1
R18008	4" cast iron dome	ABS		1
R18026	6" cast iron dome	PVC		1

Accessories for Roof Drains

MADE IN THE
USA



PART NO.	DESCRIPTION	CTN	QTY
R18011	2", 3" & 4" underdeck clamp		1
R18028	6" underdeck clamp		1
R18012	16" receiving pan		1
R18019	Plastic roof dome		1
R18020	Cast iron roof dome		1

Roof Drains w/Plastic Dome

Fits over Schedule 40 DWV Pipe



MADE IN THE
USA

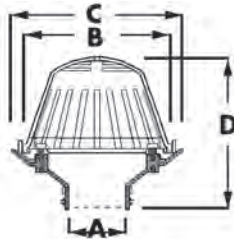

- Brass inserts in underside for underdeck clamps
- Dome has 50 square inches of free area

	A	B	C	D
Over 2" pipe		8-1/4"	11"	8"
Over 3" pipe		8-1/4"	11"	8"
Over 4" pipe		8-1/4"	11"	8"
Over 6" pipe		8-1/4"	11"	8"

PART NO.	DESCRIPTION	MATERIAL	CTN	QTY
R18013	2" plastic dome	PVC		1
R18016	2" plastic dome	ABS		1
R18014	3" plastic dome	PVC		1
R18017	3" plastic dome	ABS		1
R18015	4" plastic dome	PVC		1
R18018	4" plastic dome	ABS		1
R18027	6" plastic dome	PVC		1

A			
Access Fittings.....	51	Pipe Fit Base.....	20-21
Snap-in Access Fittings.....	52	Complete Closet Flange Extension Kit.....	4
Adapter.....	13	Complete Closet Flange Extension Kit	4
Spigot Adapter.....	13	with Gaskets.....	4
Area Drain.....	11	Condensate Traps.....	13
4-Way Area Drain.....	11	Couplings.....	13
B		PVC Couplings.....	13
Backwater Valves.....	12	PVC Multi-Use Couplings.....	13
Flapper w/Gasket for Backwater Valve.....	12	Covers.....	13, 19
Bell Traps.....	11	Cast Iron Cover Marked for Water 6" PVC Pipe.....	13
Heavy Duty PVC Bell Traps with Hinged Lids.....	11	D	
C		Drain Bases.....	14-16
Cleanout Plugs.....	50	Heavy Duty Bases.....	16
Countersunk Cleanout Plugs.....	50	Heavy Duty Bases with Clamping Ring.....	15
Raised Head Cleanout Plugs.....	50	Hub Fit Bases.....	14
Cleanouts.....	50-52	Inside Pipe Fit Base.....	14
Fit-Flush Cleanout.....	50	Pipe Fit Base.....	14
General Purpose Cleanouts.....	51	Slab Drain Bases.....	15
Heavy Duty Internal Pipe Cleanout.....	50	Drain Spuds	
Hub Fit Base.....	55	Metal Drain Spuds	
Hub Fit Cleanout with Countersunk Brass Plug.....	51	Round Strainers w/2" Metal Spuds.....	18
Hub/Fitting Cleanouts.....	50	Round Strainers w/3-1/2" Metal Spuds.....	18
Inside Pipe Fit Base.....	60	Round Strainers w/3" Metal Spuds.....	18
Internal Cleanout w/SS Cover.....	52	Round Strainers w/4" Metal Spuds.....	18
Internal Pipe Cleanout.....	50	Square Strainers w/3-1/2" Metal Spuds.....	19
Over Pipe Fit Base.....	57-60	Plastic Drain Spuds	
Pipe Fit Base.....	56-57	Round Strainers w/2" Plastic Spuds.....	17
Pipe Fit Cleanout with Cover.....	52	Round Strainers w/3-1/2" Plastic Spuds.....	17
Closet Flange.....	2-5	Round Strainers w/3" Plastic Spuds.....	17
3" Closet Flange with Long Barrel.....	3	Round Strainers w/4" Plastic Spuds.....	17
3" Over Schedule 30 Pipe Closet Flange.....	4	Square Strainers w/2" Plastic Spuds.....	18
4-Way Offset Closet Flange.....	4	Square Strainers w/3-1/2" Plastic Spuds.....	18
45° Closet Flange.....	3	Square Strainers w/3" Plastic Spuds.....	18
Closet Flange w/3-1/2"		Square Strainers w/4" Plastic Spuds.....	19
Extended Threads.....	3	E	
Offset Closet Flange.....	3	Extension.....	6
Offset Closet Flange with Metal Ring.....	4	Brass Drain Extension.....	6
Offset Plumbfit Closet Flange		Spud Extension.....	19
w/SS Ring.....	2	Tailpiece Extension.....	6
Plastic Two Finger Flange.....	3	Extension Kit.....	13
Plumbfit Closet Flange.....	2	F	
Plumbfit Closet Flanges w/Adj. Rings.....	3	Floor Drains.....	12
Plumbfit Closet Flanges		Floor Drains with Traps.....	12
with Plastic Swivel Ring.....	3	Floor Sinks.....	61
Plumbfit Closet Flange with SS Ring.....	2	Aluminum Dome Strainers	
Plumbfit Closet Flange w/Metal Rings.....	2	for Floor Sinks.....	62
Plumbfit Offset Closet Flanges		Complete PVC Floor Sink Kits.....	61
with Plastic Swivel Ring.....	3	Complete PVC Floor Sink Kits-Pipe Fit.....	62
Spigot Fit Closet Flange.....	2	Flat Aluminum Bottom Strainer	
Closet Flange Extenders.....	4	for Floor Sinks.....	62
Closet Flange Extension Kit.....	4	Full Top Grate for Floor Sinks.....	62
Closet Flange Repair Ring.....	4	Half Top Grate for Floor Sinks.....	62
Closet Flange Rings.....	4	Round Slop Sinks.....	61
Closet Flange Spacer Kit.....	5	Three-Quarters Top Grate for Floor Sinks.....	62
Commercial Drains		Funnels.....	19
Heavy Duty Drain Base.....	29-49	G	
Hub Fit Base.....	28-29	Gapper Flange.....	5
Inside Pipe Fit Base.....	27-28	General Purpose Drains.....	8, 9
Over Pipe Fit Base.....	22-49	General Purpose Drains with Long Body.....	9
		H	

Heavy Duty Traffic Floor Drains.....	10
L	
Low Profile Drain.....	7
“Perfect Low Profile” Drain	7
PVC Low Profile Drain.....	7
R	
Repair Fitting.....	13
Plastic Over-Fitting Repair Fitting.....	13
Replacement Strainers for Metal Spuds.....	18
Rings.....	19
Roof Drains.....	63
Accessories for Roof Drains.....	63
Roof Drains w/Cast Iron Dome.....	63
Roof Drains w/Plastic Dome	63
S	
Saddle Tees and Kits	52
Sewer Relief Plugs	52
Shims	
Closet Wedge Shims	5
Flexible Super Shims.....	5
Rigid Super Shims	5
Shower Drains	7
No Caulk Shower Stall Drains	8
Shower/Floor Drains.....	6
Shower/Floor Drains w/Brass Tailpiece	6
Shower/Floor Drains with Brass Tailpiece.....	7
Shower/Floor Drains with Plastic Tailpiece.....	7
Snap-in Drains.....	10
All Plastic Snap-in Drains.....	10
Snap-in Drains with Stainless Steel Strainers.....	11
Snap-in Strainers	11
Socket Ring	11
Strainers	19
T	
Test Tee w/Plug	52
U	
Urinal Flange Kits	51
Utility Drains	11
V	
Vent Caps.....	13
Flat Top Vent Cap	13
Mushroom Vent Caps	13
W	
Waxless Gasket	4

PART NO.	PG #	PART NO.	PG #	PART NO.	PG #	PART NO.	PG #
B04006	E13	C4743A	E3	C53601	E3	C59023	E60
B04007	E13	C4743P	E3	C53700	E3	C59024	E60
B04008	E13	C50300	E2	C53701	E3	C59025	E60
B04150	E12	C50301	E2	C54150	E3	C59026	E60
B04150K	E12	C50302	E3	C54340	E3	C59027	E60
B04151K	E12	C50303	E3	C54341	E3	C59028	E60
B04200	E12	C50304	E3	C54342	E4	C59029	E60
B04200K	E12	C50305	E3	C54343	E4	C59030	E60
B04201	E12	C50306	E3	C54400	E4	C59031	E60
B04201K	E12	C50307	E3	C54401	E4	C59050	E55
B04300	E12	C50308	E3	C54402	E3	C59051	E55
B04300K	E12	C50309	E3	C54403	E3	C59052	E55
B04301	E12	C50340	E2	C55043	E3	C59053	E55
B04301K	E12	C50341	E2	C55143	E3	C59054	E56
B04303	E13	C50400	E2	C57034	E2	C59055	E56
B04304	E13	C50401	E2	C57040	E2	C59056	E56
B04400	E12	C51150	E4	C57134	E2	C59057	E56
B04400K	E12	C51300	E2	C57140	E2	C59060	E55
B04401	E12	C51301	E2	C57234	E2	C59061	E55
B04403	E13	C51302	E4	C57236	E2	C59062	E55
B04404	E13	C51303	E4	C57334	E2	C59063	E55
B04600	E12	C51340	E2	C57434	E2	C59064	E57
B05150	E12	C51341	E2	C58034	E2	C59065	E57
B05150K	E12	C51350	E2	C58040	E2	C59066	E57
B05200	E12	C51351	E2	C58134	E2	C59067	E57
B05200K	E12	C51400	E2	C58140	E2	C59068	E56
B05300	E12	C51401	E2	C58234	E2	C59069	E56
B05300K	E12	C51402	E4	C58236	E2	C59070	E56
B05400	E12	C51403	E4	C58334	E2	C59071	E56
B05400K	E12	C51450	E2	C58434	E2	C59090	E60
B05600	E12	C51451	E2	C59001	E55	C59091	E60
B06001	E12	C52150	E4	C59002	E55	C59092	E60
B06010	E11	C52340	E2	C59003	E55	C59093	E60
B06100	E11	C52341	E2	C59004	E55	C59094	E60
B70499	E12	C52342	E3	C59005	E55	C59095	E60
BWV200	E13	C52343	E3	C59006	E55	C59096	E62
BWV300	E13	C52400	E2	C59007	E55	C59097	E62
BWV400	E13	C52401	E2	C59008	E55	C59098	E62
C37800	E53	C52402	E3	C59010	E56	C59099	E62
C37801	E53	C52403	E3	C59011	E56	C59100	E62
C37803	E53	C53340	E2	C59012	E56	C59101	E62
C37805	E54	C53341	E2	C59013	E56	C59102	E62
C37806	E54	C53342	E3	C59014	E56	C59103	E62
C37807	E54	C53343	E3	C59015	E56	C59200	E55
C37808	E54	C53400	E2	C59016	E56	C59201	E55
C37810	E53	C53401	E2	C59017	E56	C59202	E55
C37811	E53	C53402	E3	C59020	E60	C59203	E55
C4733A	E3	C53403	E3	C59021	E60	C59204	E55
C4733P	E3	C53600	E3	C59022	E60	C59205	E55

PART NO.	PG #	PART NO.	PG #	PART NO.	PG #	PART NO.	PG #
C59206	E55	C60031	E59	C60095	E58	C60812	E19
C59207	E55	C60032	E59	C60096	E58	C60813	E19
C59208	E57	C60033	E59	C60097	E58	C60814	E19
C59209	E57	C60040	E51	C60106	E50	C60817	E19
C59210	E57	C60041	E51	C60107	E50	C60818	E19
C59211	E57	C60042	E51	C60108	E50	C60819	E19
C59212	E57	C60043	E51	C60112	E50	C60820	E19
C59213	E57	C60044	E51	C60116	E50	C60821	E19
C59214	E57	C60045	E51	C60117	E50	C60822	E19
C59215	E57	C60046	E51	C60118	E50	C60823	E19
C59216	E56	C60047	E51	C60140	E51	C60824	E19
C59217	E56	C60050	E57	C60141	E51	C60825	E19
C59218	E56	C60051	E57	C60142	E51	C61009	E51
C59219	E56	C60052	E57	C60143	E51	C61023	E50
C59220	E56	C60053	E57	C60144	E51	C61034	E50
C59221	E56	C60054	E59	C60145	E51	C61123	E50
C59222	E56	C60055	E59	C60146	E51	C61134	E50
C59223	E56	C60056	E59	C60147	E51	C61223	E50
C59240	E62	C60057	E59	C60160	E51	C61234	E50
C59241	E62	C60060	E51	C60161	E51	C61432	E50
C59242	E62	C60061	E51	C60162	E51	C61434	E50
C59243	E62	C60062	E51	C60163	E51	C67230	E13
C59244	E62	C60063	E51	C60164	E51	C67340	E13
C59245	E62	C60064	E51	C60165	E51	C67440	E13
C59250	E62	C60065	E51	C60166	E51	C67445	E13
C59251	E62	C60066	E51	C60167	E51	C67450	E52
C60001	E57	C60067	E51	C60170	E52	C67451	E52
C60003	E57	C60070	E58	C60171	E52	C85000	E4
C60007	E50	C60071	E58	C60172	E52	C87100	E5
C60008	E50	C60072	E58	C60207	E50	C88001	E4
C60009	E50	C60073	E58	C60211	E50	C88002	E4
C60010	E50	C60074	E58	C60500	E19	C88050	E4
C60011	E50	C60075	E58	C60501	E19	C88500	E4
C60012	E50	C60076	E58	C60502	E19	C88500C	E4
C60013	E52	C60077	E58	C60503	E19	C88501	E4
C60014	E52	C60078	E58	C60504	E19	C88502	E4
C60015	E52	C60079	E58	C60505	E19	C88600	E5
C60016	E52	C60080	E58	C60800	E19	D40003	E8
C60020	E57	C60081	E58	C60801	E19	D40004	E8
C60021	E57	C60082	E58	C60802	E19	D40005	E8
C60022	E57	C60083	E58	C60803	E19	D40006	E8
C60023	E57	C60084	E59	C60804	E19	D40007	E8
C60024	E57	C60085	E59	C60805	E19	D40008	E8
C60025	E57	C60086	E59	C60806	E19	D40009	E8
C60026	E59	C60087	E59	C60807	E19	D40010	E8
C60027	E59	C60088	E59	C60808	E19	D40020	E11
C60028	E59	C60089	E59	C60809	E19	D40021	E11
C60029	E59	C60092	E58	C60810	E19	D40023	E11
C60030	E59	C60094	E58	C60811	E19	D40101	E8

PART NO.	PG #
D40140	E8
D40151	E8
D40201	E8
D40240	E8
D40401	E8
D40440	E8
D40600	E12
D40601	E12
D40602	E12
D40700	E12
D40701	E12
D40702	E12
D41001	E8
D41002	E8
D41003	E8
D41004	E8
D41007	E8
D41008	E8
D41009	E8
D41101	E8
D41102	E8
D41103	E8
D41104	E8
D41105	E8
D41106	E8
D41107	E8
D41301	E8
D41302	E8
D41303	E8
D41307	E8
D41600	E8
D41601	E8
D42002	E10
D42003	E10
D42004	E10
D42006	E11
D42006H	E11
D42007	E11
D42007H	E11
D42008	E11
D42008H	E11
D42009	E11
D42009H	E11
D42010	E11
D42010H	E11
D42011	E11
D42012	E11
D42013	E11
D42014	E11

PART NO.	PG #
D42015	E11
D42019	E11
D42022	E10
D42023	E10
D42024	E10
D42029	E11
D49001	E34
D49002	E34
D49003	E34
D49004	E34
D49005	E34
D49006	E34
D49007	E34
D49008	E34
D49009	E34
D49010	E34
D49011	E34
D49012	E34
D49013	E34
D49014	E34
D49019	E34
D49020	E34
D49021	E34
D49022	E34
D49023	E34
D49024	E34
D49025	E34
D49026	E34
D49027	E34
D49028	E34
D49029	E34
D49030	E34
D49031	E34
D49032	E34
D49033	E34
D49034	E34
D49035	E34
D49036	E34
D49037	E35
D49038	E35
D49039	E35
D49040	E35
D49041	E35
D49042	E35
D49043	E35
D49044	E35
D49045	E35
D49046	E35
D49047	E35

PART NO.	PG #
D49048	E35
D49049	E35
D49050	E35
D49051	E35
D49052	E35
D49053	E35
D49054	E35
D49055	E35
D49056	E35
D49057	E35
D49058	E35
D49059	E35
D49060	E35
D49061	E35
D49062	E35
D49063	E35
D49064	E35
D49065	E35
D49066	E35
D49077	E36
D49078	E36
D49079	E36
D49080	E36
D49081	E36
D49082	E36
D49083	E36
D49084	E36
D49085	E36
D49086	E36
D49087	E36
D49088	E36
D49089	E36
D49090	E36
D49095	E36
D49096	E36
D49097	E36
D49098	E36
D49101	E31
D49102	E31
D49103	E31
D49104	E31
D49105	E31
D49106	E31
D49107	E31
D49108	E31
D49109	E31
D49110	E31
D49111	E31
D49112	E31

PART NO.	PG #
D49113	E31
D49114	E31
D49119	E31
D49120	E31
D49121	E31
D49122	E31
D49123	E32
D49124	E32
D49125	E32
D49126	E32
D49127	E32
D49128	E32
D49129	E32
D49130	E32
D49131	E32
D49132	E32
D49133	E32
D49134	E32
D49135	E32
D49136	E32
D49137	E32
D49138	E32
D49139	E32
D49140	E32
D49141	E32
D49142	E32
D49143	E32
D49144	E32
D49145	E32
D49146	E32
D49147	E32
D49148	E32
D49149	E32
D49150	E32
D49151	E33
D49152	E33
D49153	E33
D49154	E33
D49155	E33
D49156	E33
D49157	E33
D49158	E33
D49159	E33
D49160	E33
D49161	E33
D49162	E33
D49163	E33
D49164	E33
D49165	E33

PART NO.	PG #	PART NO.	PG #	PART NO.	PG #	PART NO.	PG #
D49166	E33	D49235	E29	D49298	E31	D49353	E43
D49177	E33	D49236	E29	D49301	E41	D49354	E43
D49178	E33	D49237	E30	D49302	E41	D49355	E43
D49179	E33	D49238	E30	D49303	E41	D49356	E43
D49180	E33	D49239	E30	D49304	E41	D49357	E43
D49181	E33	D49240	E30	D49305	E41	D49358	E43
D49182	E33	D49241	E30	D49306	E41	D49359	E43
D49183	E33	D49242	E30	D49307	E41	D49360	E43
D49184	E33	D49243	E30	D49308	E41	D49361	E43
D49185	E33	D49244	E30	D49309	E41	D49362	E43
D49186	E33	D49245	E30	D49310	E41	D49363	E43
D49187	E33	D49246	E30	D49311	E41	D49364	E43
D49188	E33	D49247	E30	D49312	E41	D49365	E43
D49189	E33	D49248	E30	D49313	E41	D49366	E43
D49190	E33	D49249	E30	D49314	E41	D49377	E43
D49195	E33	D49250	E30	D49319	E41	D49378	E43
D49196	E33	D49251	E30	D49320	E41	D49379	E43
D49197	E33	D49252	E30	D49321	E41	D49380	E43
D49198	E33	D49253	E30	D49322	E41	D49381	E43
D49201	E29	D49254	E30	D49323	E42	D49382	E43
D49202	E29	D49255	E30	D49324	E42	D49383	E43
D49203	E29	D49256	E30	D49325	E42	D49384	E43
D49204	E29	D49257	E30	D49326	E42	D49385	E43
D49205	E29	D49258	E30	D49327	E42	D49386	E43
D49206	E29	D49259	E30	D49328	E42	D49387	E43
D49207	E29	D49260	E30	D49329	E42	D49388	E43
D49208	E29	D49261	E30	D49330	E42	D49389	E43
D49209	E29	D49262	E30	D49331	E42	D49390	E43
D49210	E29	D49263	E30	D49332	E42	D49395	E43
D49211	E29	D49264	E30	D49333	E42	D49396	E43
D49212	E29	D49265	E30	D49334	E42	D49397	E43
D49213	E29	D49266	E30	D49335	E42	D49398	E43
D49214	E29	D49277	E31	D49336	E42	D49401	E39
D49219	E29	D49278	E31	D49337	E42	D49402	E39
D49220	E29	D49279	E31	D49338	E42	D49403	E39
D49221	E29	D49280	E31	D49339	E42	D49404	E39
D49222	E29	D49281	E31	D49340	E42	D49405	E39
D49223	E29	D49282	E31	D49341	E42	D49406	E39
D49224	E29	D49283	E31	D49342	E42	D49407	E39
D49225	E29	D49284	E31	D49343	E42	D49408	E39
D49226	E29	D49285	E31	D49344	E42	D49409	E39
D49227	E29	D49286	E31	D49345	E42	D49410	E39
D49228	E29	D49287	E31	D49346	E42	D49411	E39
D49229	E29	D49288	E31	D49347	E42	D49412	E39
D49230	E29	D49289	E31	D49348	E42	D49413	E39
D49231	E29	D49290	E31	D49349	E42	D49414	E39
D49232	E29	D49295	E31	D49350	E42	D49419	E39
D49233	E29	D49296	E31	D49351	E43	D49420	E39
D49234	E29	D49297	E31	D49352	E43	D49421	E39

PART NO.	PG #
D49422	E39
D49423	E39
D49424	E39
D49425	E39
D49426	E39
D49427	E39
D49428	E39
D49429	E39
D49430	E39
D49431	E39
D49432	E39
D49433	E39
D49434	E39
D49435	E39
D49436	E39
D49437	E40
D49438	E40
D49439	E40
D49440	E40
D49441	E40
D49442	E40
D49443	E40
D49444	E40
D49445	E40
D49446	E40
D49447	E40
D49448	E40
D49449	E40
D49450	E40
D49451	E40
D49452	E40
D49453	E40
D49454	E40
D49455	E40
D49456	E40
D49457	E40
D49458	E40
D49459	E40
D49460	E40
D49461	E40
D49462	E40
D49463	E40
D49464	E40
D49465	E40
D49466	E40
D49467	E40
D49468	E40
D49469	E40
D49470	E40

PART NO.	PG #
D49471	E40
D49472	E40
D49473	E40
D49474	E40
D49475	E40
D49476	E40
D49477	E41
D49478	E41
D49479	E41
D49480	E41
D49481	E41
D49482	E41
D49483	E41
D49484	E41
D49485	E41
D49486	E41
D49487	E41
D49488	E41
D49489	E41
D49490	E41
D49495	E41
D49496	E41
D49497	E41
D49498	E41
D49501	E36
D49502	E36
D49503	E36
D49504	E36
D49505	E36
D49506	E36
D49507	E36
D49508	E36
D49509	E36
D49510	E36
D49511	E36
D49512	E36
D49513	E36
D49514	E36
D49519	E36
D49520	E36
D49521	E36
D49522	E36
D49523	E37
D49524	E37
D49525	E37
D49526	E37
D49527	E37
D49528	E37
D49529	E37

PART NO.	PG #
D49530	E37
D49531	E37
D49532	E37
D49533	E37
D49534	E37
D49535	E37
D49536	E37
D49537	E37
D49538	E37
D49539	E37
D49540	E37
D49541	E37
D49542	E37
D49543	E37
D49544	E37
D49545	E37
D49546	E37
D49547	E37
D49548	E37
D49549	E37
D49550	E37
D49551	E38
D49552	E38
D49553	E38
D49554	E38
D49555	E38
D49556	E38
D49557	E38
D49558	E38
D49559	E38
D49560	E38
D49561	E38
D49562	E38
D49563	E38
D49564	E38
D49565	E38
D49566	E38
D49577	E38
D49578	E38
D49579	E38
D49580	E38
D49581	E38
D49582	E38
D49583	E38
D49584	E38
D49585	E38
D49586	E38
D49587	E38
D49588	E38

PART NO.	PG #
D49589	E38
D49590	E38
D49595	E38
D49596	E38
D49597	E38
D49598	E38
D49800	E15
D49801	E15
D49802	E15
D49803	E15
D49804	E15
D49805	E15
D49806	E15
D49807	E15
D49808	E15
D49810	E15
D49811	E15
D49812	E15
D49813	E15
D49814	E15
D49815	E15
D49816	E15
D49817	E15
D49818	E15
D49820	E10
D49821	E10
D49822	E10
D49823	E10
D49824	E10
D49825	E10
D49826	E10
D49827	E10
D49828	E10
D49829	E10
D49830	E10
D49831	E10
D49850	E15
D49851	E15
D49852	E15
D49853	E15
D49854	E15
D49855	E15
D49856	E15
D49857	E15
D49858	E15
D49860	E15
D49861	E15
D49862	E15
D49863	E15

PART NO.	PG #	PART NO.	PG #	PART NO.	PG #	PART NO.	PG #
D49864	E15	D50067	E46	D50188	E10	D50367	E49
D49865	E15	D50068	E48	D50200	E12	D50368	E49
D49866	E15	D50069	E44	D50201	E11	D50371	E49
D49867	E15	D50070	E46	D50202	E12	D50372	E49
D49868	E15	D50071	E48	D50203	E12	D50377	E10
D49924	E10	D50072	E44	D50204	E12	D50378	E10
D50001	E6	D50073	E46	D50205	E12	D50379	E10
D50002	E6	D50074	E48	D50206	E12	D50380	E10
D50004	E46	D50075	E44	D50207	E12	D50381	E10
D50005	E46	D50076	E46	D50208	E12	D50382	E10
D50006	E46	D50077	E48	D50213	E12	D50383	E10
D50007	E47	D50089	E10	D50220	E11	D50384	E10
D50008	E47	D50090	E10	D50221	E11	D50385	E10
D50010	E6	D50091	E10	D50278	E44	D50386	E10
D50011	E6	D50092	E10	D50279	E45	D50387	E10
D50012	E46	D50093	E10	D50280	E47	D50388	E10
D50013	E46	D50094	E10	D50301	E6	D50389	E10
D50014	E46	D50095	E10	D50302	E6	D50390	E10
D50015	E47	D50101	E6	D50310	E6	D50391	E10
D50016	E47	D50102	E6	D50311	E6	D50392	E10
D50022	E44	D50111	E6	D50330	E6	D50393	E10
D50023	E44	D50120	E6	D50331	E6	D50394	E10
D50027	E44	D50121	E6	D50332	E6	D50401	E6
D50028	E44	D50122	E6	D50333	E6	D50402	E6
D50037	E44	D50123	E6	D50334	E6	D50411	E6
D50038	E45	D50124	E6	D50335	E6	D50481	E62
D50039	E47	D50125	E7	D50340	E48	D50482	E62
D50040	E44	D50126	E7	D50341	E48	D50500	E7
D50041	E45	D50130	E6	D50342	E48	D50501	E7
D50042	E47	D50131	E6	D50343	E48	D50502	E7
D50044	E44	D50132	E6	D50344	E48	D50510	E7
D50045	E45	D50133	E6	D50345	E48	D50511	E7
D50046	E47	D50134	E6	D50346	E48	D50600	E12
D50047	E44	D50135	E6	D50349	E48	D50601	E11
D50048	E45	D50152	E6	D50350	E48	D50682	E10
D50049	E47	D50153	E6	D50351	E49	D50683	E10
D50050	E44	D50161	E6	D50352	E49	D50700	E7
D50051	E45	D50162	E6	D50353	E49	D50701	E7
D50052	E47	D50177	E10	D50354	E49	D50702	E7
D50053	E44	D50178	E10	D50355	E49	D50703	E7
D50054	E45	D50179	E10	D50356	E49	D50704	E7
D50055	E47	D50180	E10	D50357	E49	D50705	E7
D50060	E44	D50181	E10	D50360	E49	D50706	E7
D50061	E46	D50182	E10	D50361	E49	D50707	E7
D50062	E47	D50183	E10	D50362	E49	D50708	E7
D50063	E44	D50184	E10	D50363	E49	D50709	E7
D50064	E46	D50185	E10	D50364	E49	D50710	E7
D50065	E47	D50186	E10	D50365	E49	D50711	E7
D50066	E44	D50187	E10	D50366	E49	D50712	E7

PART NO.	PG #
D50713	E7
D50714	E7
D50715	E7
D50720	E7
D50721	E7
D50722	E7
D50723	E7
D50724	E7
D50725	E7
D50726	E7
D50727	E7
D50800	E6
D50802	E6
D50830	E6
D50832	E6
D50904	E10
D50905	E10
D50906	E10
D50907	E10
D50908	E10
D50909	E10
D50910	E10
D50911	E10
D50980	E17
D50982	E17
D50983	E17
D50984	E17
D50985	E17
D50986	E17
D50987	E17
D50988	E17
D50989	E18
D50990	E18
D50998	E6
D50PLP	E7
D51004	E46
D51005	E46
D51006	E46
D51007	E47
D51008	E47
D51012	E46
D51013	E46
D51014	E46
D51015	E47
D51016	E47
D51022	E44
D51023	E44
D51027	E44
D51028	E44

PART NO.	PG #
D51037	E44
D51038	E45
D51039	E47
D51040	E44
D51041	E45
D51042	E47
D51044	E44
D51045	E45
D51046	E47
D51047	E44
D51048	E45
D51049	E47
D51050	E44
D51051	E45
D51052	E47
D51053	E44
D51054	E45
D51055	E47
D51060	E44
D51061	E46
D51062	E47
D51063	E44
D51064	E46
D51065	E47
D51066	E44
D51067	E46
D51068	E48
D51069	E44
D51070	E46
D51071	E48
D51072	E44
D51073	E46
D51074	E48
D51075	E44
D51076	E46
D51077	E48
D51278	E44
D51279	E45
D51280	E47
D51340	E48
D51341	E48
D51342	E48
D51343	E48
D51344	E48
D51345	E48
D51346	E48
D51349	E48
D51350	E48
D51351	E49

PART NO.	PG #
D51352	E49
D51353	E49
D51354	E49
D51355	E49
D51356	E49
D51357	E49
D51360	E49
D51361	E49
D51362	E49
D51363	E49
D51364	E49
D51365	E49
D51366	E49
D51367	E49
D51368	E49
D51371	E49
D51372	E49
D52003	E14
D52004	E14
D52005	E14
D52012	E14
D52013	E14
D52014	E14
D52016	E14
D52017	E14
D52023	E14
D52103	E14
D52104	E14
D52105	E14
D52112	E14
D52120	E14
D52123	E14
D52202	E16
D52203	E16
D52204	E16
D52205	E16
D52206	E16
D52207	E16
D52216	E16
D52217	E16
D52302	E16
D52303	E16
D52304	E16
D52305	E16
D52306	E16
D52307	E16
D52316	E16
D52317	E16
D52400	E14

PART NO.	PG #
D52450	E14
D52451	E14
D52452	E14
D52453	E14
D52460	E14
D52461	E14
D52462	E14
D52463	E14
D52500	E14
D53001	E28
D53002	E28
D53003	E28
D53004	E28
D53005	E28
D53006	E28
D53008	E28
D53009	E28
D53011	E28
D53012	E28
D53014	E28
D53015	E28
D53017	E28
D53018	E28
D53020	E20
D53021	E20
D53022	E20
D53023	E20
D53024	E20
D53025	E20
D53026	E21
D53027	E21
D53028	E21
D53029	E21
D53030	E21
D53031	E21
D53032	E21
D53033	E21
D53034	E21
D53035	E21
D53036	E21
D53037	E21
D53040	E22
D53041	E22
D53042	E22
D53043	E22
D53044	E22
D53045	E22
D53046	E23
D53047	E23

PART NO.	PG #	PART NO.	PG #	PART NO.	PG #	PART NO.	PG #
D53048	E23	D53097	E23	D53154	E27	D53235	E27
D53049	E23	D53098	E23	D53155	E27	D53236	E27
D53050	E23	D53099	E23	D53156	E27	D53237	E27
D53051	E23	D53100	E25	D53157	E27	D53238	E27
D53052	E23	D53101	E25	D53158	E27	D53239	E27
D53053	E23	D53102	E25	D53159	E27	D53240	E27
D53054	E23	D53103	E25	D53160	E27	D53241	E27
D53055	E23	D53104	E25	D53161	E27	D53246	E20
D53056	E23	D53105	E25	D53162	E27	D53247	E20
D53057	E23	D53106	E25	D53163	E27	D53248	E20
D53058	E28	D53107	E25	D53180	E28	D53249	E20
D53059	E28	D53108	E25	D53181	E28	D53250	E22
D53060	E28	D53109	E25	D53182	E28	D53251	E22
D53061	E28	D53110	E25	D53183	E28	D53252	E22
D53062	E28	D53111	E25	D53184	E28	D53253	E22
D53063	E28	D53120	E28	D53185	E28	D53258	E25
D53064	E29	D53121	E28	D53186	E28	D53259	E25
D53065	E29	D53122	E28	D53187	E28	D53260	E25
D53066	E29	D53123	E28	D53188	E28	D53261	E25
D53067	E29	D53124	E21	D53189	E28	D53262	E23
D53068	E29	D53125	E21	D53190	E26	D53263	E23
D53069	E29	D53126	E21	D53191	E26	D53264	E23
D53070	E29	D53127	E21	D53192	E26	D53265	E23
D53071	E29	D53128	E23	D53193	E26	D53266	E23
D53072	E20	D53129	E23	D53194	E26	D53267	E24
D53073	E20	D53130	E23	D53195	E26	D53268	E24
D53074	E20	D53131	E23	D53196	E26	D53269	E23
D53075	E20	D53132	E23	D53197	E26	D53272	E23
D53076	E20	D53133	E23	D53198	E26	D53273	E23
D53077	E20	D53134	E23	D53199	E26	D53274	E23
D53078	E21	D53135	E23	D53200	E26	D53275	E23
D53079	E21	D53136	E23	D53201	E26	D53276	E23
D53080	E21	D53137	E23	D53202	E26	D53277	E24
D53081	E21	D53138	E21	D53203	E26	D53278	E24
D53082	E21	D53139	E21	D53204	E26	D53279	E23
D53083	E21	D53140	E21	D53205	E26	D53280	E28
D53084	E21	D53141	E21	D53206	E26	D53281	E28
D53085	E21	D53142	E21	D53207	E26	D53282	E22
D53086	E22	D53143	E21	D53208	E26	D53283	E22
D53087	E22	D53144	E46	D53209	E26	D53284	E20
D53088	E22	D53145	E46	D53216	E26	D53285	E20
D53089	E22	D53146	E46	D53217	E26	D53286	E23
D53090	E22	D53147	E46	D53218	E26	D53287	E23
D53091	E22	D53148	E46	D53219	E26	D53288	E25
D53092	E23	D53149	E46	D53230	E27	D53289	E25
D53093	E23	D53150	E27	D53231	E27	D53290	E26
D53094	E23	D53151	E27	D53232	E27	D53291	E26
D53095	E23	D53152	E27	D53233	E27	D53292	E27
D53096	E23	D53153	E27	D53234	E27	D53293	E27

PART NO.	PG #
D53294	E27
D53295	E27
D53296	E26
D53297	E26
D53298	E26
D53299	E26
D53300	E27
D53301	E27
D53302	E27
D53303	E27
D53304	E24
D53305	E24
D53306	E25
D53307	E25
D53308	E24
D53309	E24
D53310	E27
D53311	E27
D53312	E25
D53313	E25
D53314	E27
D53315	E27
D53400	E28
D53401	E28
D53402	E28
D53403	E28
D53404	E28
D53405	E28
D53406	E28
D53407	E28
D53408	E28
D53409	E28
D53410	E28
D53411	E28
D53412	E28
D53413	E28
D53414	E22
D53415	E22
D53416	E22
D53417	E22
D53418	E22
D53419	E22
D53420	E22
D53421	E22
D53422	E22
D53423	E22
D53424	E22
D53425	E22
D53426	E22

PART NO.	PG #
D53427	E22
D53428	E20
D53429	E20
D53430	E20
D53431	E20
D53432	E20
D53433	E20
D53434	E20
D53435	E20
D53436	E20
D53437	E20
D53438	E20
D53439	E20
D53440	E20
D53441	E20
D53442	E44
D53443	E44
D53444	E44
D53445	E44
D53446	E44
D53447	E44
D53448	E44
D53449	E44
D53450	E44
D53451	E44
D53452	E44
D53453	E44
D53454	E44
D53455	E44
D53456	E45
D53457	E45
D53458	E45
D53459	E45
D53460	E45
D53461	E45
D53462	E45
D53463	E45
D53464	E45
D53465	E45
D53466	E45
D53467	E45
D53468	E45
D53469	E45
D53470	E47
D53471	E47
D53472	E47
D53473	E47
D53474	E47
D53475	E47

PART NO.	PG #
D53476	E47
D53477	E47
D53478	E47
D53479	E47
D53480	E47
D53481	E47
D53482	E47
D53483	E47
D54001	E8
D54001L	E9
D54002	E8
D54002L	E9
D54003	E11
D54004	E11
D54005	E11
D54006	E11
D54008	E19
D54010	E19
D54011	E8
D54012	E8
D54013	E8
D54013L	E9
D54014	E8
D54014L	E9
D54015	E8
D54016	E9
D54022	E8
D54100	E9
D54101	E9
D54102	E9
D54104	E9
D54105	E9
D54107	E9
D54108	E19
D54109	E19
D54111	E9
D54112	E9
D54113	E9
D54114	E9
D54126	E9
D54130	E9
D54131	E9
D54132	E9
D54133	E9
D54134	E9
D54136	E9
D54137	E9
D54301	E8
D54302	E8

PART NO.	PG #
D54304	E9
D54305	E9
D54306	E9
D54307	E9
D54311	E8
D54312	E8
D54313	E8
D54314	E8
D54315	E8
D54316	E9
D54319	E8
D54321	E9
D54322	E9
D54323	E9
D54324	E9
D54326	E9
D54330	E9
D54331	E9
D54332	E9
D54333	E9
D54334	E9
D54336	E9
D54337	E9
D54400	E9
D54401	E9
D56105	E17
D56106	E17
D56107	E17
D56205	E17
D56206	E17
D56207	E17
D56208	E17
D56209	E17
D56210	E17
D56211	E17
D56212	E17
D56213	E17
D56214	E17
D56215	E17
D56216	E17
D56217	E17
D56304	E17
D56305	E17
D56306	E17
D56307	E17
D56308	E17
D56309	E17
D56404	E17
D56405	E17

PART NO.	PG #	PART NO.	PG #	PART NO.	PG #	PART NO.	PG #
D56406	E17	D57907	E53	D59923	E53	D60992	E18
D56407	E17	D57908	E53	D59924	E53	D60993	E18
D56408	E17	D57909	E53	D59925	E53	D60994	E18
D56409	E17	D57910	E54	D59926	E53	D60995	E18
D56500	E18	D57911	E54	D59927	E53	D60996	E18
D56501	E18	D57912	E54	D59943	E53	D60997	E18
D56502	E18	D57913	E54	D59944	E53	D60998	E18
D56503	E18	D57914	E53	D59945	E53	D60999	E18
D56504	E19	D57915	E53	D59946	E53	F10001	E51
D56505	E19	D57916	E53	D59947	E53	F10002	E51
D57105	E17	D57917	E53	D59948	E53	F10003	E51
D57106	E17	D57918	E54	D59949	E53	F10004	E51
D57107	E17	D57919	E54	D59950	E53	F11001	E51
D57205	E17	D57980	E17	D60780	E18	F11002	E51
D57206	E17	D57982	E17	D60781	E18	F11003	E51
D57207	E17	D57983	E17	D60782	E18	F11004	E51
D57208	E17	D57984	E17	D60790	E18	F65400	E19
D57209	E17	D57985	E17	D60791	E18	F65600	E19
D57210	E17	D57986	E17	D60792	E18	M05034	E13
D57211	E17	D57987	E17	D60793	E18	M05134	E13
D57212	E17	D57988	E17	D60794	E18	P15050	E13
D57213	E17	D57989	E18	D60795	E18	P15075	E13
D57214	E17	D57990	E18	D60940	E18	P15175	E13
D57215	E17	D59001	E11	D60945	E18	P22100	E13
D57216	E17	D59002	E11	D60954	E19	P22101	E13
D57217	E17	D59003	E11	D60955	E18	P22200	E13
D57304	E17	D59100	E19	D60956	E18	P22201	E13
D57305	E17	D59900	E20	D60958	E18	P22300	E13
D57306	E17	D59901	E53	D60959	E18	P22400	E13
D57307	E17	D59902	E53	D60960	E19	P48002	E11
D57308	E17	D59904	E53	D60961	E19	P48003	E11
D57309	E17	D59905	E53	D60962	E19	P48004	E11
D57404	E17	D59906	E53	D60963	E19	P48102	E11
D57405	E17	D59907	E53	D60966	E18	P48103	E11
D57406	E17	D59908	E53	D60967	E18	P48104	E11
D57407	E17	D59909	E53	D60968	E18	P49002	E50
D57408	E17	D59910	E54	D60969	E18	P49003	E50
D57409	E17	D59911	E54	D60970	E18	P49004	E50
D57500	E18	D59912	E54	D60975	E18	P49015	E50
D57501	E18	D59913	E54	D60978	E6	P49025	E50
D57502	E18	D59914	E53	D60979	E19	P49035	E50
D57503	E18	D59915	E53	D60980	E18	P49150	E50
D57504	E19	D59916	E53	D60981	E18	P49200	E50
D57505	E19	D59917	E53	D60982	E18	P49250	E50
D57901	E53	D59918	E54	D60986	E18	P49300	E50
D57902	E53	D59919	E54	D60987	E18	P49350	E50
D57904	E53	D59920	E53	D60989	E18	P49400	E50
D57905	E53	D59921	E53	D60990	E18	P49600	E50
D57906	E53	D59922	E53	D60991	E18	P49915	E50

PART NO.	PG #
P49920	E50
P49925	E50
P49930	E50
P49935	E50
P49940	E50
R15050	E13
R15075	E13
R18001	E63
R18005	E63
R18006	E63
R18007	E63
R18008	E63
R18009	E63
R18011	E63
R18012	E63
R18013	E63
R18014	E63
R18015	E63
R18016	E63
R18017	E63
R18018	E63
R18019	E63
R18020	E63
R18026	E63
R18027	E63
R18028	E63
S25150	E52
S25200	E52
S25250	E52
S25300	E52
S25350	E52
S25400	E52
S26004	E52
S26005	E52
S26006	E52
S26007	E52
S26008	E52
S26009	E52
S26010	E52
S26011	E52
S26012	E52
S26014	E52
S26015	E52
S26016	E52
S26017	E52
S49042	E61
S49043	E61
S49044	E61
S49052	E61

PART NO.	PG #
S49053	E61
S49054	E61
S49062	E61
S49063	E61
S49064	E61
S49072	E61
S49073	E61
S49074	E61
S49082	E61
S49083	E61
S49084	E61
S49092	E61
S49093	E61
S49094	E61
S55001	E61
S55002	E61
S55902	E5
S55903	E5
S55950	E5
S55951	E5
S55952	E5
S55953	E5
S59002	E61
S59003	E61
S59004	E61
S59010	E62
S59011	E62
S59012	E62
S59042	E62
S59043	E62
S59044	E62
S59052	E62
S59053	E62
S59054	E62
S59062	E62
S59063	E62
S59064	E62
S59072	E62
S59073	E62
S59074	E62
S59082	E62
S59083	E62
S59084	E62
S59092	E62
S59093	E62
S59094	E62
S59102	E61
S59103	E61
S59104	E61

PART NO.	PG #
S59302	E61
S59303	E61
S59304	E61
S59310	E62
S59311	E62
S59312	E62
S59402	E61
S59403	E61
S60002	E62
S60003	E62
S60004	E62
S60005	E62



SECTION F - CAST IRON

VOLUME V



Quality
Products *for*
the Plumbing
Professional

Closet Flanges & Accessories	2-3
Drain Bodies.....	4-5
Spuds & Strainers.....	5-6
Assembled Cast Iron Drains	7-14
Cleanout Bodies & Spuds.....	15-16
Cleanout Plugs	17-18
Cleanout Cover Plates.....	19
Assembled Cleanouts.....	20-22
Roof Drains.....	23
General Purpose Drains.....	24-25
Bell Traps.....	26
Floor & Cesspool Drains/Grates.....	27
Service Sinks & Accessories	28
Bar Grates/Sewer Strainers & Boxes	29
Vent Boxes/Caps/Backwater Valves	30
Test Tees & Closet Bends.....	31
Gas Burners/Log Lighter Valves/Accessories	32-33
Product Index.....	34
Part Number Index.....	35-40

The Exclusive Two Finger Flange

Patent #: 5,937,450



- Flush fit
- Redesigned to fit oblong horns
- Made of cast iron
- Pushes easily into cast iron or Schedule 40 DWV pipe
- No tear out or caulking required
- ASTM C-564 rubber gasket
- 3" x 2", 4" x 2" and 4" x 3": for areas with the bend close to the flange
- 3" x 4", 4" x 4" and 4" x 6": for areas without the bend close to the flange or broken pipe



PART NO.	DESCRIPTION	CTN QTY
C47320	3" x 2"	8
C47340	3" x 4"	4
C47420	4" x 2"	8
C47430	4" x 3"	4
C47440	4" x 4"	4
C47460	4" x 6"	2

Inside Caulk Closet Flange



- Notched and slotted
- Inside caulk connection



Service Weight

PART NO.	DESCRIPTION	CTN QTY
C41410	4" x 1"	10
C41411	4" x 1-1/2"	10
C41420	4" x 2"	8
C41421	4" x 2-1/2"	8
C41430	4" x 3"	6
C41440	4" x 4"	4
C41460	4" x 6"	2
Extra Heavy - 5" I.D. - NO BEAD		
C42421	4" x 2-1/2"	8
C42440	4" x 4"	4
C42460	4" x 6"	2

Inside Caulk Reducing Closet Flange



- Notched and slotted



PART NO.	DESCRIPTION	CTN QTY
C45433	4" inlet x 3" outlet x 3" depth	6

No Caulk Closet Flange w/Test Cap



- Slotted
- Stainless bolts and washers

PART NO.	DESCRIPTION	CTN QTY
C40425	4" x 2" No Caulk	4

"Code Blue" No Caulk Closet Flange



- Four stainless bolts and washers
- Neoprene gasket meets ASTM C564
- Ideal for both repair and new construction
- Easy to install- reduces installation time by 80%
- Push over cast iron or plastic pipe, anchor to floor and tighten bolts



PART NO.	DESCRIPTION	CTN QTY
C40320	3" pipe x 2" depth	8
C40420*	4" pipe x 2" depth	8
C40430*	4" pipe x 3" depth	4
C40440*	4" pipe x 4" depth	4

"Code Blue" No Caulk Closet Flange w/Test Cap



- Cut out neoprene test cap
- Stainless steel bolts



PART NO.	DESCRIPTION	CTN QTY
C40500	4" x 2"	8
C40503	3" x 3"	8

No Hub Closet Flange



- Notched and slotted



PART NO.	DESCRIPTION	CTN QTY
C46331*	3" x 3-1/2"	6
C46431	4" x 3-1/2"	6
C46351*	3" x 5-1/2"	6
C46451	4" x 5-1/2"	6

2" Offset Closet Flange



PART NO.	DESCRIPTION	CONNECTION	CTN QTY
C43440	4" x 4" x 2"	Inside Caulk	4
C43441	4" x 4" x 2"	No Hub	4

" Code Blue" 1" Offset Closet Flange



• 5/16" bolt slots



PART NO.	DESCRIPTION	CONNECTION	CTN QTY
C40640	4"	No Caulk	4

Four Way Offset Closet Flange



• 1-1/2" offset
• Internal clip allows 360° offset capability

PART NO.	DESCRIPTION	CONNECTION	CTN QTY
C44420	4" x 2"	Inside Caulk	8
C44440	4" x 4"	Inside Caulk	4

Brass Closet Flange



PART NO.	DESCRIPTION	CTN QTY
C49440	14 oz.	50
C49441	Deep seal 1-1/8"	50
C49442	16 oz.	50

Brass Four Way Offset Closet Flange



• Clip allows four way 1-1/2" offset
• For use with lead bends

PART NO.	DESCRIPTION	CTN QTY
C49421	4" x 2"	8

Closest Flange Repair Ring



• Securely attaches to concrete or wood sub-floor
• Replaces most closet rings
• Corrosion Resistant• Mounting ears offset by 1/8" to allow closet bolts to be installed

PART NO.	DESCRIPTION	CTN QTY
C85000	Closest flange repair ring	6

Gapper Flange



• Used to repair broken closet flanges
• Individually carded for easy display or bulk

PART NO.	DESCRIPTION	CTN QTY
C87100	Repair flange carded	25

Flange Support For Wood Floors



• Supports flange if floor has rotted or if rough-in hole is too large
• Easy to install- complete kit includes screws
• Cast iron fits 3" or 4" flange; plastic fits 3", 4" or 3"x 4" flange
• Individually carded

PART NO.	DESCRIPTION	CTN QTY
C01001	Flange support for plastic	10
C01002	Flange support for cast iron	10

Moss Bay Repair Flange



• For corroded and rusted toilet flanges
• Installs in minutes

PART NO.	DESCRIPTION	CTN QTY
C85500	Moss bay repair flange	1

Shower Drain Bodies w/Clamping Ring And Bolts



- Tongue and groove cast iron bolt down clamping ring
- Weep holes on both top and bottom for secondary drainage
- Inside caulk unit can be used with gasket to make unit no caulk
- For 2" IPS threaded tailpieces

PART NO.	SIZE	PAN	HEIGHT	CTN QTY
D60900	2" Inside Caulk	6-1/2"	2-1/2"	1
D60901	2" FIP	6-1/2"	2-1/2"	1
D60902	2" No Hub	6-1/2"	2-1/2"	1

Shower Drain Bodies w/Brass Threaded Clamping Ring And Bolts



- Designed for lead pan showers
- Weep holes in clamping ring
- For 2" IPS threaded tailpieces

PART NO.	SIZE	PAN	HEIGHT	CTN QTY
D61800	2" FIP	6-3/8"	3-1/4"	1
D61801	2" No Hub	6-3/8"	3-1/4"	1
D61802	2" Inside Caulk	6-3/8"	3-1/4"	1

Heavy Duty Drain Bodies



- For use with heavy duty floor drains
- For 3-1/2" IPS threaded tailpieces

PART NO.	SIZE	PAN	HEIGHT	CTN QTY
D80097	3" No Hub	10-1/2"	3-1/2"	1
D80099	3" Inside Caulk	10-1/2"	3-1/2"	1
D80090	3" No Hub; 1/2 PT	10-1/2"	3-1/2"	1
D80096	4" No Hub	10-1/2"	3-1/2"	1
D80098	4" Inside Caulk	10-1/2"	3-1/2"	1
D80091	4" No Hub; 1/2 PT	10-1/2"	3-1/2"	1

"Code Blue" No Caulk (Mechanical Joint) Drain Bodies



- 1/2" Primer tapped with brass plug
- Supplied with stainless steel bolts
- Test plug included
- Tapped for 3-1/2" spud

PART NO.	SIZE	PAN	SPUD	HEIGHT	CTN QTY
D65002	2"	7"	3-1/2"	2-1/2"	1
D66002	2"	9"	3-1/2"	3-1/8"	1
D65003	3"	7"	3-1/2"	2-1/2"	1
D66003	3"	9"	3-1/2"	3-1/8"	1
D66004	4"	9"	3-1/2"	3-1/8"	1

"Code Blue" No Hub Drain Bodies



- Tapped for 3-1/2" spud
- 1/2" Primer tapped with brass plug
- Supplied with stainless steel bolts

PART NO.	SIZE	PAN	SPUD	HEIGHT	CTN QTY
D65102	2"	7"	3-1/2"	2-1/2"	1
D66102	2"	9"	3-1/2"	3-1/8"	1
D65103	3"	7"	3-1/2"	2-1/2"	1
D66103	3"	9"	3-1/2"	3-1/4"	1
D65104	4"	7"	3-1/2"	2-1/2"	1
D66104	4"	9"	3-1/2"	3-1/8"	1

"Code Blue" IPS Drain Bodies



- Tapped for 3-1/2" spud
- 1/2" Primer tapped with brass plug
- Supplied with stainless steel bolts

PART NO.	SIZE	PAN	SPUD	HEIGHT	CTN QTY
D65202	2"	7"	3-1/2"	2-1/2"	1
D66202	2"	9"	3-1/2"	3-1/8"	1
D65203	3"	7"	3-1/2"	2-1/2"	1
D66203	3"	9"	3-1/2"	3-1/8"	1
D66204	4"	9"	3-1/2"	3-1/8"	1

"Code Blue" No Caulk (Mechanical Joint) Slab Drain Bodies



- 1/2" Primer tap
- Less clamping ring
- Tapped for 3-1/2" spud

PART NO.	SIZE	PAN	SPUD	HEIGHT	CTN QTY
D67201	2"	7"	3-1/2"	3-3/8"	1

"Code Blue" No Hub Slab Drain Bodies



- Tapped for 3-1/2" spud
- 1/2" Primer tapped with brass plug
- Less clamping ring

PART NO.	SIZE	PAN	SPUD	HEIGHT	CTN QTY
D67200	2"	7"	3-1/2"	3-3/8"	1
D67300	3"	7"	3-1/2"	3-3/8"	1
D67400	4"	7"	3-1/2"	3-3/8"	1

"Code Blue" Push-On Drain Bodies



- Tapped for 3-1/2" spud
- 1/2" Primer tapped with brass plug
- Supplied with stainless steel bolts
- For PVC connections, you must replace with extra heavy Dual Tite gaskets

PART NO.	SIZE	PAN	SPUD	HEIGHT	CTN QTY
D66200	2"	9"	3-1/2"	3-3/4"	1
D66300	3"	9"	3-1/2"	3-3/4"	1
D66400	4"	9"	3-1/2"	3-3/4"	1

No Hub Base



- Use with CI strainers or covers for heavy trucking traffic
- Use with PB, NB, SS or CP strainers or covers for heavy pedestrian traffic

NOTE: 3" No hub will receive a 2" multi-tite gasket and therefore becomes a 2" push-on body. 4" No hub will receive a 3" multi-tite gasket.

PART NO.	NO HUB BASE x SPUD	HEIGHT	CTN QTY
D63300	3"x 3" IPS	4-1/4"	1
D63349	3"x 3-1/2" IPS	4-1/4"	1
D63350	4"X 3-1/2" IPS	4-1/4"	1
D63400	4"x 4" IPS	4-1/4"	1

Gasket Connection Base



- Supplied with Multi-Tite gasket
- Use with CI strainers or covers for heavy trucking traffic
- Use with PB, NB, SS or CP strainers or covers for heavy pedestrian traffic

PART NO.	S.V. BASE x SPUD	HEIGHT	CTN QTY
D62300	3"x 3" IPS	5-1/4"	1
D62349	3"x 3-1/2" IPS	5-1/4"	1
D62350	4"x 3-1/2" IPS	5-1/2"	1
D62400	4"x 4" IPS	5-1/2"	1

3-1/2" Spud Extension



- 2-1/2"-4" extension for a 3-1/2" drain/ cleanout spud
- Use on cast iron or PVC drain bodies when additional height is needed to offset inconsistent concrete pours

PART NO.	DESCRIPTION	CTN QTY
D60979	3-1/2" Spud Extension	1

Cast Iron Spuds w/Strainers For Heavy Duty Drain Bodies



- For use with heavy duty floor drains

2-1/2" IPS threaded throat for testing w/round strainer

PART NO.	SPUD	STRAINER	CTN QTY
D62130	3" IPS	4-9/16" CI	1
D62131	3" IPS	5" NB with ring	1
D62132	3" IPS	5" PB with ring	1

3" IPS threaded throat for testing with round strainer

PART NO.	SPUD	STRAINER	CTN QTY
D62135	3-1/2" IPS	5-1/2" CI	1
D62136	3-1/2" IPS	6" NB with ring	1
D62137	3-1/2" IPS	6" PB with ring	1

3-1/2" IPS threaded throat for testing w/round strainer

PART NO.	SPUD	STRAINER	CTN QTY
D62140	4" IPS	5-1/2" CI	1
D62141	4" IPS	6" NB with ring	1
D62142	4" IPS	6" PB with ring	1

Plastic Spuds w/Square Strainers & Tops for Heavy Duty Drain Bodies



- For use with heavy duty floor drains
- 5" round cover with 7" square top

PART NO.	SPUD	STRAINER	CTN QTY
D56500	3" IPS	PB	1
D56501	3" IPS	NB	1
D56502	3-1/2" IPS	PB	1
D56503	3-1/2" IPS	NB	1
D56504	4" IPS	PB	1
D56505	4" IPS	NB	1

Metal Spuds w/Strainers For Drain Bodies



- For use with floor drains

IPS Spud w/Round Strainer

PART NO.	SIZE	STRAINER	SCREWS	CTN QTY
D60980	2"	4" SS stamped	2 (3-3/8")	1
D60981	2"	4" Chrome cast	2 (3-3/8")	1
D60982	2"	4" PB cast	2 (3-3/8")	1
D60970	2"	6" CP	2 (5")	1
D60975	2"	6" PB	2 (5")	1
D60955	3"	5" NB	3 (3-7/8")	1
D60956	3"	5" PB	3 (3-7/8")	1
D60986	3-1/2"	4" NB	2 (3-1/4")	1
D60987	3-1/2"	4" PB	2 (3-1/4")	1
D60990	3-1/2"	5" CP	3 (3-7/8")	1
D60991	3-1/2"	5" PB	3 (3-7/8")	1
D60996	3-1/2"	5" NB	3 (3-7/8")	1
D60997	3-1/2"	6" NB	3 (4-3/4")	1
D60992	3-1/2"	6" CP	2 (5")	1
D60993	3-1/2"	6" PB	2 (5")	1
D60994	3-1/2"	8" CP	4 (6-3/4")	1
D60995	3-1/2"	8" PB	4 (6-3/4")	1
D60998	3-1/2"	8" NB	4 (6-3/4")	1
D60989	3-1/2"	9" PB	4 (7-5/8")	1
D60999	3-1/2"	9" NB	4 (7-5/8")	1
D60958	4"	5" NB	3 (3-7/8")	1
D60959	4"	5" PB	3 (3-7/8")	1

3-1/2" IPS Metal Spud



PART NO.	SPUD	STRAINER	CTN QTY
D60986	3-1/2"	4" NB	1
D60987	3-1/2"	4" PB	1
Replacement Strainer			
D60966	Replacement Strainer for D60-986		1
D60967	Replacement Strainer for D60-987		1

Metal Spuds w/Strainers For Drain Bodies



- For use with floor drains

IPS Spud w/Square Strainer

PART NO.	SIZE	STRAINER	SCREWS	CTN QTY
D60954	3-1/2"	5" CP	4 (3-7/8")	1
D60960	3-1/2"	5" PB	4 (3-7/8")	1
D60962	3-1/2"	5" NB	4 (3-7/8")	1
D60961	3-1/2"	6" PB	4 (4-7/8")	1
D60963	3-1/2"	6" NB	4 (4-7/8")	1

Funnels



- Vandal- proof installation
- Fits virtually any floor/ shower drain
- Funnel tapped for 10-24 screws which are supplied with washers

PART NO.	DESCRIPTION	CTN QTY
F65400	4" Funnel	1
F65600	6" Funnel	1

"Code Blue" EZ Test Shower Drains



- Includes cover plate and stainless steel screws

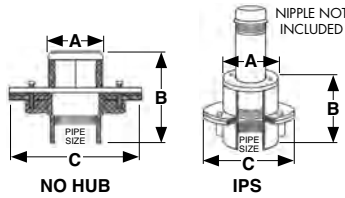

PIPE SIZE	A	B	C
1-1/2"	3-1/2"	4-1/4"	6"
2"	3-1/2"	4-1/4"	7"

PART NO.	SIZE	BASE	STRAINER	CTN QTY
D64150	1-1/2" IPS	6"	SS	1
D64202	2" IPS	6"	SS	1
D64012*	2" IPS	7"	SS	1
D64302*	2" No hub	6"	SS	1

"Code Blue" Roman Tub Drains



- 6" and 7" pans
- Non-adjustable
- Polished chrome, polished brass and satin nickel finishes with PVD protective finish

PART NO.	SIZE	BASE	FINISH	CTN QTY
D64800	2" IPS	7"	CP	1
D64801	2" No Caulk	7"	CP	1
D64802	2" IPS	6"	CP	1
D64803	2" No Caulk	6"	CP	1
D64804	2" IPS	7"	PB	1
D64805	2" No Caulk	7"	PB	1
D64806	2" IPS	6"	PB	1
D64807	2" No Caulk	6"	PB	1
D64808	2" IPS	7"	SN	1
D64809	2" No Caulk	7"	SN	1
D64810	2" IPS	6"	SN	1
D64811	2" No Caulk	6"	SN	1

"Code Blue" Shower Drains



- Includes cover plate and stainless steel screws
- No caulk includes built-in test plug

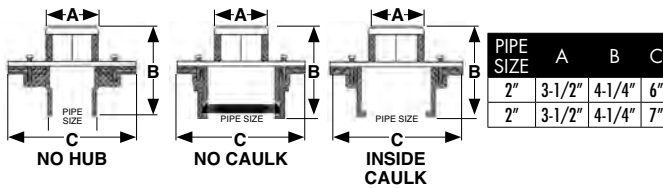

PIPE SIZE	A	B	C
2"	3-1/2"	4-1/4"	6"
2"	3-1/2"	4-1/4"	7"

PART NO.	SIZE	BASE	STRAINER	CTN QTY
D64502	2" No Caulk	6"	SS	1
D64002*	2" No Caulk	7"	SS	1
D64402	2" Inside Caulk	6"	SS	1
D64402G	D64-402 + Gasket	6"	SS	1
D64022*	2" No Hub	7"	SS	1

"Code Blue" Replacement Strainers



- Roman tub drains
- Fits non-adjustable "Code Blue" drains

PART NO.	DESCRIPTION	CTN QTY
D40000	Chrome plated	1
D40001	PB/PVD	1
D40002	Satin Nickel/PVD	1

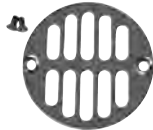

- Regular Strainers
- Fits non-adjustable "Code Blue" drains

PART NO.	DESCRIPTION	CTN QTY
D64000	2" SS	1
D64401	SS Crown	1
D64001	2" PB/PVD	1
D6400BN	Brushed Nickel	1
D6400NP	Pearl Nickel	1
D6400RB	Oil Rubbed Bronze	1
D6400WB	Old World Bronze	1

"Code Blue" Non-Adjustable Drain



PART NO.	TOP	BASE	CTN QTY
D64010	Cast Iron	ABS Base	1
D64011 (with test cap)	Cast Iron	ABS Base	1

2" Shower and Floor Drains



- Tongue and groove cast iron bolt down clamping ring
- Weep holes on both top and bottom for secondary drainage
- Inside caulk unit can be used with gasket to make unit no-caulk

2" IPS Brass Spud with 4" Round Strainer

PART NO.	SIZE	PAN	STRAINER	CTN	QTY
D60100	2" Inside Caulk	6-1/2"	SS	8	
D60102	2" FIP	6-1/2"	SS	8	
D60103	2" No Hub	6-1/2"	SS	8	
D60101	2" Gasket for inside caulk unit			1	

2" IPS Brass Spud with 4" Cast Brass Round Strainer

PART NO.	SIZE	PAN	STRAINER	CTN	QTY
D60201	2" Inside Caulk	6-1/2"	CP	8	
D60202	2" Inside Caulk	6-1/2"	PB	8	
D60203	2" FIP	6-1/2"	CP	8	
D60204	2" FIP	6-1/2"	PB	8	
D60205	2" No Hub	6-1/2"	CP	8	
D60206	2" No Hub	6-1/2"	PB	8	

2" IPS Brass Spud with 6" Cast Round Strainer

PART NO.	SIZE	PAN	STRAINER	CTN	QTY
D60211	2" Inside Caulk	6-1/2"	CP	1	
D60212	2" Inside Caulk	6-1/2"	PB	1	
D60207	2" FIP	6-1/2"	CP	1	
D60208	2" FIP	6-1/2"	PB	1	
D60209	2" No Hub	6-1/2"	CP	1	
D60210	2" No Hub	6-1/2"	PB	1	

2" IPS Brass Spud with 4" Cast Square Strainer

PART NO.	SIZE	PAN	STRAINER	CTN	QTY
D60400	2" Inside Caulk	6-1/2"	CP	1	
D60410	2" Inside Caulk	6-1/2"	PB	1	
D60402	2" FIP	6-1/2"	CP	1	
D60412	2" FIP	6-1/2"	PB	1	
D60403	2" No Hub	6-1/2"	CP	1	
D60413	2" No Hub	6-1/2"	PB	1	
D60499	2" Inside Caulk Push On	6-1/2"	CP	1	
D60498	2" Inside Caulk Push On	6-1/2"	PB	1	

2" Shower Drains With Brass Threaded Clamping Ring



- Designed for lead pan showers
- Weep holes in clamping ring

2" IPS Brass Spud With 4" Round Strainer

PART NO.	SIZE	PAN	STRAINER	CTN	QTY
D61101	2" IPS	6-1/2"	SS	4	
D61102	2" No Hub	6-1/2"	SS	4	
D61103	2" Inside Caulk	6-1/2"	SS	4	

2" IPS Brass Spud With 4" Cast Brass Round Strainer

PART NO.	SIZE	PAN	STRAINER	CTN	QTY
D61201	2" IPS	6-1/2"	CP	4	
D61202	2" No Hub	6-1/2"	CP	4	
D61203	2" Inside Caulk	6-1/2"	CP	4	

2" IPS Brass Spud With 6" Cast Brass Round Strainer

PART NO.	SIZE	PAN	STRAINER	CTN	QTY
D61301	2" IPS	6-1/2"	PB	4	
D61302	2" No Hub	6-1/2"	PB	4	
D61303	2" Inside Caulk	6-1/2"	PB	4	
D61850	Brass screw-down clamping ring			1	

2" "Code Blue" No Caulk (Mechanical Joint) Floor Drains



- 1/2" Primer tapped with brass plug
- Supplied with stainless steel bolts

3 1/2" IPS Spuds With 4", 5", or 6" Round Strainer

PART NO.	SIZE	PAN	STRAINER	HEIGHT	CTN QTY
D65661	2"	7"	4" NB	4" - 4 13/16"	1
D65662	2"	7"	4" PB	4" - 4 13/16"	1
D66681	2"	9"	4" NB	4" - 4 13/16"	1
D66682	2"	9"	4" PB	4" - 4 13/16"	1
D65500	2"	7"	5" NB	4" - 5"	1
D65501	2"	7"	5" PB	4" - 5"	1
D65502	2"	7"	5" CP	4" - 5"	1
D66500	2"	9"	5" NB	4" - 5"	1
D66501	2"	9"	5" PB	4" - 5"	1
D66502	2"	9"	5" CP	4" - 5"	1
D65503	2"	7"	6" NB	4 1/4" - 5 1/4"	1
D65504	2"	7"	6" PB	4 1/4" - 5 1/4"	1
D65505	2"	7"	6" CP	4 1/4" - 5 1/4"	1
D66503	2"	9"	6" NB	4 1/4" - 5 1/4"	1
D66504	2"	9"	6" PB	4 1/4" - 5 1/4"	1
D66505	2"	9"	6" CP	4 1/4" - 5 1/4"	1

3 1/2" IPS Spuds with 5" or 6" Square Strainer

PART NO.	SIZE	PAN	STRAINER	HEIGHT	CTN QTY
D65509	2"	7"	5" NB	4 1/4" - 5 1/4"	1
D65511	2"	7"	5" PB	4 1/4" - 5 1/4"	1
D66509	2"	9"	5" NB	4 1/4" - 5 1/4"	1
D66511	2"	9"	5" PB	4 1/4" - 5 1/4"	1
D65510	2"	7"	6" NB	4 1/4" - 5 1/4"	1
D65512	2"	7"	6" PB	4 1/4" - 5 1/4"	1
D66510	2"	9"	6" NB	4 1/4" - 5 1/4"	1
D66512	2"	9"	6" PB	4 1/4" - 5 1/4"	1

2" "Code Blue" (Mechanical Joint) No Caulk Slab Drain



- No Clamping Ring

3 1/2" Spud With 4", 5" or 6" Round Strainer

PART NO.	SIZE	PAN	STRAINER	HEIGHT	CTN QTY
D67001	2"	7"	4" NB	3 3/4" - 4 3/4"	1
D67002	2"	7"	4" PB	3 3/4" - 4 3/4"	1
D67003	2"	7"	5" NB	3 3/4" - 4 7/8"	1
D67004	2"	7"	5" PB	4" - 5 3/8"	1
D67005	2"	7"	5" CP	3 1/2" - 4 7/8"	1
D67006	2"	7"	6" NB	3 3/4" - 5 1/8"	1
D67007	2"	7"	6" PB	3 3/4" - 5 1/8"	1
D67008	2"	7"	6" CP	4" - 5 1/2"	1

2" "Code Blue" No Hub Floor Drain



- 1/2" Primer tapped with brass plug
- Supplied with stainless steel bolts

3 1/2" IPS Spuds with 4", 5" or 6" Round Strainer

PART NO.	SIZE	PAN	STRAINER	HEIGHT	CTN QTY
D66675	2"	9"	4" NB	3 3/4" - 4 5/8"	1
D66676	2"	9"	4" PB	3 3/4" - 4 5/8"	1
D65655	2"	7"	4" NB	3 3/4" - 4 7/16"	1
D65656	2"	7"	4" PB	3 3/4" - 4 7/16"	1
D65560	2"	7"	5" NB	2 7/8" - 4 1/2"	1
D65561	2"	7"	5" PB	2 7/8" - 4 1/2"	1
D65562	2"	7"	5" CP	2 7/8" - 4 1/2"	1
D66560	2"	9"	5" NB	3 1/2" - 5 1/8"	1
D66561	2"	9"	5" PB	3 1/2" - 5 1/8"	1
D66562	2"	9"	5" CP	3 1/2" - 5 1/8"	1
D65563	2"	7"	6" NB	4" - 5 1/4"	1
D65564	2"	7"	6" PB	4" - 5 1/4"	1
D65565	2"	7"	6" CP	4" - 5 1/4"	1
D66563	2"	9"	6" NB	3 5/8" - 5 5/8"	1
D66564	2"	9"	6" PB	3 5/8" - 5 5/8"	1
D66565	2"	9"	6" CP	3 5/8" - 5 5/8"	1

3 1/2" IPS Spuds with 5" or 6" Square Strainer

PART NO.	SIZE	PAN	STRAINER	HEIGHT	CTN QTY
D65569	2"	7"	5" NB	3 1/4" - 5 1/4"	1
D65571	2"	7"	5" PB	3 1/4" - 5 1/4"	1
D66569	2"	9"	5" NB	3 7/8" - 5 7/8"	1
D66571	2"	9"	5" PB	3 7/8" - 5 7/8"	1
D65570	2"	7"	6" NB	4" - 5 1/4"	1
D65572	2"	7"	6" PB	4" - 5 1/4"	1
D66570	2"	9"	6" NB	4 1/8" - 6 3/8"	1
D66572	2"	9"	6" PB	4 1/8" - 6 3/8"	1

2" "Code Blue" No Hub Slab Drain



- No Clamping Ring

3 1/2" Spud with 4", 5" or 6" Round Strainer

PART NO.	SIZE	PAN	STRAINER	HEIGHT	CTN QTY
D67016	2"	7"	4" NB	3 5/8" - 4 3/4"	1
D67017	2"	7"	4" PB	3 5/8" - 4 3/4"	1
D67018	2"	7"	5" NB	3 1/2" - 4 7/8"	1
D67019	2"	7"	5" PB	4" - 5 3/8"	1
D67020	2"	7"	5" CP	3 1/2" - 4 7/8"	1
D67021	2"	7"	6" NB	3 7/8" - 5"	1
D67022	2"	7"	6" PB	3 3/4" - 5"	1
D67023	2"	7"	6" CP	4" - 5 3/8"	1

3 1/2" Spud with 5" or 6" Square Strainer

PART NO.	SIZE	PAN	STRAINER	HEIGHT	CTN QTY
D67027	2"	7"	5" NB	3 3/4" - 5 1/8"	1
D67028	2"	7"	5" PB	3 3/4" - 5 1/8"	1
D67029	2"	7"	6" NB	4" - 5 3/16"	1
D67030	2"	7"	6" PB	4" - 5 3/16"	1

2" "Code Blue" Push-On Floor Drain



- With Clamping Ring
- Supplied with V96-002 gasket for 2" cast iron pipe

3 1/2" Stud with 4", 5" or 6" Round Strainer

PART NO.	SIZE	PAN	STRAINER	HEIGHT	CTN QTY
D66700	2"	9"	4" NB	4 5/8" - 5 1/2"	1
D66701	2"	9"	4" PB	4 5/8" - 5 1/2"	1
D66702	2"	9"	5" NB	4 5/8" - 5 1/2"	1
D66703	2"	9"	5" PB	5 3/16" - 6 1/8"	1
D66704	2"	9"	5" CP	4 3/4" - 5 1/2"	1
D66705	2"	9"	6" NB	4 7/8" - 5 3/4"	1
D66706	2"	9"	6" PB	4 7/8" - 5 3/4"	1
D66707	2"	9"	6" CP	5 1/4" - 6 1/4"	1

Bronze Shower Drains



- Heavy bronze body
- Suitable for residential and commercial installation
- 4-1/2" strainers in stainless steel or PVD polished brass
- Solid bronze strainer spuds in standard (1-1/2") or extra long (2-1/2") length
- 3 types of 2" connections

2" IPS Drain

PART NO.	SPUD	STRAINER	CTN QTY
D68510	Standard	SS	1
D68511	Standard	PB	1
D68512	Long Pattern	SS	1
D68513	Long Pattern	PB	1

2" Caulk Drain

PART NO.	SPUD	STRAINER	CTN QTY
D68610	Standard	SS	1
D68611	Standard	PB	1
D68612	Long Pattern	SS	1
D68613	Long Pattern	PB	1

2" Sweat Drain

PART NO.	SPUD	STRAINER	CTN QTY
D68710	Standard	SS	1
D68711	Standard	PB	1
D68712	Long Pattern	SS	1
D68713	Long Pattern	PB	1

Replacement Strainers

PART NO.	DESCRIPTION	CTN QTY
D68507	4 1/2" SS strainer with screws	1
D68508	4 1/2" PVD PB strainer with screws	1

2" "Code Blue" IPS Floor Drain



- 1/2" Primer tapped with brass plug
- Supplied with stainless steel bolts

3 1/2" IPS Spuds with 4", 5" or 6" Round Strainer

PART NO.	SIZE	PAN	STRAINER	HEIGHT	CTN QTY
D66687	2"	9"	4" NB	3 1/4" - 4"	1
D66688	2"	9"	4" PB	3 1/4" - 4"	1
D65665	2"	7"	4" NB	3 3/16" - 4 3/16"	1
D65620	2"	7"	5" NB	2 7/8" - 4 1/2"	1
D65621	2"	7"	5" PB	2 7/8" - 4 1/2"	1
D65622	2"	7"	5" CP	2 7/8" - 4 1/2"	1
D66620	2"	9"	5" NB	3 1/2" - 5 1/8"	1
D66621	2"	9"	5" PB	3 1/2" - 5 1/8"	1
D66622	2"	9"	5" CP	3 1/2" - 5 1/8"	1
D65623	2"	7"	6" NB	3 1/2" - 4 1/2"	1
D65624	2"	7"	6" PB	3 1/2" - 4 1/2"	1
D65625	2"	7"	6" CP	3 1/2" - 4 1/2"	1
D66623	2"	9"	6" NB	3 5/8" - 5 5/8"	1
D66624	2"	9"	6" PB	3 5/8" - 5 5/8"	1
D66625	2"	9"	6" CP	3 5/8" - 5 5/8"	1

3" Heavy Duty No Hub Floor/ Shower Drain



- Cast metal strainer and tailpiece
- Cast iron body

3 1/2" IPS Spuds with 5" or 6" Round Strainer

PART NO.	SIZE	PAN	STRAINER	HEIGHT	CTN QTY
D80200	3"	10"	5" CP	4 1/2" - 6 1/2"	1
D80201	3"	10"	5" PB	4 1/2" - 6 1/2"	1
D80212	3"	10"	5" NB	4 1/2" - 6 1/2"	1
D80202	3"	10"	6" CP	4 1/2" - 6 1/2"	1
D80203	3"	10"	6" PB	4 1/2" - 6 1/2"	1
D80213	3"	10"	6" NB	4 1/2" - 6 1/2"	1

3 1/2" IPS Spuds with 5" or 6" Square Strainer

PART NO.	SIZE	PAN	STRAINER	HEIGHT	CTN QTY
D80214	3"	10"	5" PB	4 1/2" - 6 1/2"	1
D80216	3"	10"	5" NB	4 1/2" - 6 1/2"	1
D80215	3"	10"	6" PB	4 1/2" - 6 1/2"	1
D80217	3"	10"	6" NB	4 1/2" - 6 1/2"	1

3" Heavy Duty Inside Caulk Floor/ Shower Drain



- Cast metal strainer and tailpiece
- Cast iron body

3 1/2" IPS Spud with 5", 6" or 8" Round Strainer

PART NO.	SIZE	PAN	STRAINER	HEIGHT	CTN QTY
D80100	3"	10"	5" CP	4 1/2" - 6 1/2"	1
D80101	3"	10"	5" PB	4 1/2" - 6 1/2"	1
D80112	3"	10"	5" NB	4 1/2" - 6 1/2"	1
D80102	3"	10"	6" CP	4 3/4" - 6 3/4"	1
D80103	3"	10"	6" PB	4 3/4" - 6 3/4"	1
D80113	3"	10"	6" NB	4 3/4" - 6 3/4"	1

3" "Code Blue" No Caulk (Mechanical Joint) Floor Drain



- 1/2" Primer tapped with brass plug
- Supplied with stainless steel bolts



3 1/2" IPS Spuds with 4", 5" or 6" Round Strainer

PART NO.	SIZE	PAN	STRAINER	HEIGHT	CTN QTY
D66683	3"	9"	4" NB	4" - 4 3/4"	1
D66684	3"	9"	4" PB	4" - 4 3/4"	1
D65663	3"	7"	4" NB	4" - 4 13/16"	1
D65664	3"	7"	4" PB	4" - 4 13/16"	1
D65520	3"	7"	5" NB	2 7/8" - 4 1/2"	1
D65521	3"	7"	5" PB	2 7/8" - 4 1/2"	1
D65522	3"	7"	5" CP	2 7/8" - 4 1/2"	1
D66520	3"	9"	5" NB	3-1/2" - 5-1/8"	1
D66521	3"	9"	5" PB	3-1/2" - 5-1/8"	1
D66522	3"	9"	5" CP	3-1/2" - 5-1/8"	1
D65523	3"	7"	6" NB	3" - 5"	1
D65524	3"	7"	6" PB	3" - 5"	1
D65525	3"	7"	6" CP	3" - 5"	1
D66523	3"	9"	6" NB	3-5/8" - 5-5/8"	1
D66524	3"	9"	6" PB	3-5/8" - 5-5/8"	1
D66525	3"	9"	6" CP	3-5/8" - 5-5/8"	1

3" "Code Blue" No Hub Slab Drain



- No Clamping Ring

3 1/2" Spud with 4", 5", 6", 8" or 9" Round Strainer

PART NO.	SIZE	PAN	STRAINER	HEIGHT	CTN QTY
D67031	3"	7"	4" NB	3 1/2" - 4 3/4"	1
D67032	3"	7"	4" PB	3 1/2" - 4 3/4"	1
D67033	3"	7"	5" NB	3 1/2" - 4 13/16"	1
D67034	3"	7"	5" PB	4" - 5 5/16"	1
D67035	3"	7"	5" CP	3 1/2" - 4 13/16"	1
D67036	3"	7"	6" NB	3 3/4" - 5"	1
D67037	3"	7"	6" PB	3 3/4" - 5"	1
D67038	3"	7"	6" CP	4" - 5 3/8"	1
D67039	3"	7"	8" NB	4 1/8" - 5 5/8"	1
D67040	3"	7"	8" PB	4 1/8" - 5 5/8"	1
D67041	3"	7"	8" CP	4 1/4" - 5 5/8"	1
D67042	3"	7"	9" NB	4 1/4" - 5 5/8"	1
D67043	3"	7"	9" PB	4 1/4" - 5 5/8"	1

3 1/2" Spud With 5" or 6" Square Strainer

PART NO.	SIZE	PAN	STRAINER	HEIGHT	CTN QTY
D67044	3"	7"	5" NB	3 3/4" - 5 1/16"	1
D67045	3"	7"	5" PB	3 7/8" - 5 1/16"	1
D67046	3"	7"	6" NB	4" - 5 1/4"	1
D67047	3"	7"	6" PB	4" - 5 1/4"	1

3" "Code Blue" No Hub Floor Drain



- 1/2" Primer tapped with brass plug
- Supplied with stainless steel bolts

3 1/2" IPS Spuds With 4", 5" or 6" Round Strainer

PART NO.	SIZE	PAN	STRAINER	HEIGHT	CTN QTY
D65657	3"	7"	4" NB	3 3/4" - 4 7/16"	1
D65658	3"	7"	4" PB	3 3/4" - 4 7/16"	1
D66677	3"	9"	4" NB	3 3/4" - 4 5/8"	1
D66678	3"	9"	4" PB	3 3/4" - 4 5/8"	1
D65580	3"	7"	5" NB	2 7/8" - 4 1/2"	1
D65581	3"	7"	5" PB	2 7/8" - 4 1/2"	1
D65582	3"	7"	5" CP	2 7/8" - 4 1/2"	1
D66580	3"	9"	5" NB	3 1/2" - 5 1/8"	1
D66581	3"	9"	5" PB	3 1/2" - 5 1/8"	1
D66582	3"	9"	5" CP	3 1/2" - 5 1/8"	1
D65583	3"	7"	6" NB	3" - 5"	1
D65584	3"	7"	6" PB	3" - 5"	1
D65585	3"	7"	6" CP	3" - 5"	1
D66583	3"	9"	6" NB	3 5/8" - 5 5/8"	1
D66584	3"	9"	6" PB	3 5/8" - 5 5/8"	1
D66585	3"	9"	6" CP	3 5/8" - 5 5/8"	1

3" "Code Blue" Push-On Floor Drain



- With Clamping Ring
- Supplied with V96-003 gasket for 3" cast iron pipe

3 1/2" Spuds with 4", 5" or 6" Round Strainer

PART NO.	SIZE	PAN	STRAINER	HEIGHT	CTN QTY
D66715	3"	9"	4" NB	4 3/4" - 5 5/8"	1
D66716	3"	9"	4" PB	4 3/4" - 5 5/8"	1
D66717	3"	9"	5" NB	4 3/4" - 5 5/8"	1
D66718	3"	9"	5" PB	5 3/8" - 6 1/4"	1
D66719	3"	9"	5" CP	4 3/4" - 5 5/8"	1
D66720	3"	9"	6" NB	5" - 6"	1
D66721	3"	9"	6" PB	5" - 6"	1
D66722	3"	9"	6" CP	5 3/8" - 6 3/8"	1

3" "Code Blue" IPS Floor Drain



- 1/2" Primer tapped with brass plug
- Supplied with stainless steel bolts

3 1/2" IPS Spuds with 4", 5" or 6" Round Strainer

PART NO.	SIZE	PAN	STRAINER	HEIGHT	CTN QTY
D66689	3"	9"	4" NB	3 1/4" x 4"	1
D66690	3"	9"	4" PB	3 1/4" x 4"	1
D65667	3"	7"	4" NB	3 3/16" - 4 13/16"	1
D65668	3"	7"	4" PB	3 3/16" - 4 13/16"	1
D65640	3"	7"	5" NB	2 7/8" - 4 1/2"	1
D65641	3"	7"	5" PB	2 7/8" - 4 1/2"	1
D65642	3"	7"	5" CP	2 7/8" - 4 1/2"	1
D66640	3"	9"	5" NB	3 1/2" - 5 1/8"	1
D66641	3"	9"	5" PB	3 1/2" - 5 1/8"	1
D66642	3"	9"	5" CP	3 1/2" - 5 1/8"	1
D65643	3"	7"	6" NB	3" - 5"	1
D65644	3"	7"	6" PB	3" - 5"	1
D65645	3"	7"	6" CP	3" - 5"	1
D66643	3"	9"	6" NB	3 5/8" - 5 5/8"	1
D66644	3"	9"	6" PB	3 5/8" - 5 5/8"	1
D66645	3"	9"	6" CP	3 5/8" - 5 5/8"	1

4" Heavy Duty No Hub Floor/ Shower Drain



- Cast metal strainer and tailpiece
- Cast iron body

3 1/2" IPS Spuds with 5", 6" or 8" Round Strainer

PART NO.	SIZE	PAN	STRAINER	HEIGHT	CTN QTY
D80206	4"	10"	5" CP	4 1/2" - 6 1/2"	1
D80207	4"	10"	5" PB	4 1/2" - 6 1/2"	1
D80218	4"	10"	5" NB	4 1/2" - 6 1/2"	1
D80208	4"	10"	6" CP	4 3/4" - 6 3/4"	1
D80209	4"	10"	6" PB	4 3/4" - 6 3/4"	1
D80219	4"	10"	6" NB	4 3/4" - 6 3/4"	1
D80210	4"	10"	8" CP	5" - 7"	1
D80211	4"	10"	8" PB	5" - 7"	1

3 1/2" IPS Spuds with 5" or 6" Square Strainer

PART NO.	SIZE	PAN	STRAINER	HEIGHT	CTN QTY
D80220	4"	10"	5" PB	4 1/2" - 6 1/2"	1
D80222	4"	10"	5" NB	4 1/2" - 6 1/2"	1
D80221	4"	10"	6" PB	4 3/4" - 6 3/4"	1
D80223	4"	10"	6" NB	4 3/4" - 6 3/4"	1

4" Heavy Duty Inside Caulk Floor/ Shower Drain



- Cast metal strainer or tailpiece
- Cast iron body

3 1/2" IPS Spuds with 5", 6", or 8" Round Strainer

PART NO.	SIZE	PAN	STRAINER	HEIGHT	CTN QTY
D80106	4"	10"	5" CP	4 1/2" - 6 1/2"	1
D80107	4"	10"	5" PB	4 1/2" - 6 1/2"	1
D80118	4"	10"	5" NB	4 1/2" - 6 1/2"	1
D80108	4"	10"	6" CP	4 3/4" - 6 3/4"	1
D80109	4"	10"	6" PB	4 3/4" - 6 3/4"	1
D80119	4"	10"	6" NB	4 3/4" - 6 3/4"	1

4" "Code Blue" No Caulk (Mechanical Joint) Floor Drain



- 1/2" Primer tapped with brass plug
- Supplied with stainless steel bolts

3 1/2" IPS Spuds with 4", 5" or 6" Round Strainer

PART NO.	SIZE	PAN	STRAINER	HEIGHT	CTN QTY
D66685	4"	9"	4" NB	4" - 4 7/8"	1
D66686	4"	9"	4" PB	4" - 4 7/8"	1
D66540	4"	9"	5" NB	3 1/2" - 5 1/8"	1
D66541	4"	9"	5" PB	3 1/2" - 5 1/8"	1
D66542	4"	9"	5" CP	3 1/2" - 5 1/8"	1
D66543	4"	9"	6" NB	3 5/8" - 5 5/8"	1
D66544	4"	9"	6" PB	3 5/8" - 5 5/8"	1
D66545	4"	9"	6" CP	3 5/8" - 5 5/8"	1

4" "Code Blue" IPS Floor Drain



- 1/2" Primer tapped with brass plug
- Supplied with stainless steel bolts

3 1/2" IPS Spuds with 4", 5" or 6" Round Strainer

PART NO.	SIZE	PAN	STRAINER	HEIGHT	CTN QTY
D66691	4"	9"	4" NB	3 1/4" - 4"	1
D66692	4"	9"	4" PB	3 1/4" - 4"	1
D66660	4"	9"	5" NB	3 1/2" - 5 1/8"	1
D66661	4"	9"	5" PB	3 1/2" - 5 1/8"	1
D66662	4"	9"	5" CP	3 1/2" - 5 1/8"	1
D66663	4"	9"	6" NB	3 5/8" - 5 5/8"	1
D66664	4"	9"	6" PB	3 5/8" - 5 5/8"	1
D66665	4"	9"	6" CP	3 5/8" - 5 5/8"	1

4" "Code Blue" No Hub Floor Drain



- 1/2" Primer tapped with brass plug
- Supplied with stainless steel bolts

3 1/2" IPS Spuds with 4", 5" or 6" Round Strainer

PART NO.	SIZE	PAN	STRAINER	HEIGHT	CTN QTY
D66679	4"	9"	4" NB	3 3/8" - 4 5/8"	1
D66680	4"	9"	4" PB	3 3/8" - 4 5/8"	1
D65659	4"	7"	4" NB	3 3/4" - 4 7/16"	1
D65660	4"	7"	4" PB	3 3/4" - 4 7/16"	1
D65600	4"	7"	5" NB	3 1/2" - 4 3/4"	1
D65601	4"	7"	5" PB	3 1/2" - 4 3/4"	1
D65602	4"	7"	5" CP	3 1/2" - 4 3/4"	1
D66600	4"	9"	5" NB	3 1/2" - 4 3/4"	1
D66601	4"	9"	5" PB	3 1/2" - 4 3/4"	1
D66602	4"	9"	5" CP	3 1/2" - 4 3/4"	1
D65603	4"	7"	6" NB	3 3/4" - 5"	1
D65604	4"	7"	6" PB	3 3/4" - 5"	1
D65605	4"	7"	6" CP	3 3/4" - 5"	1
D66603	4"	9"	6" NB	3 3/4" - 5"	1
D66604	4"	9"	6" PB	3 3/4" - 5"	1
D66605	4"	9"	6" CP	3 3/4" - 5"	1

4" "Code Blue" Push-On Floor Drain



- With clamping ring
- Supplied with V96-004 gasket for 4" cast iron pipe

3 1/2" Spuds with 4", 5" or 6" Round Strainer

PART NO.	SIZE	PAN	STRAINER	HEIGHT	CTN QTY
D66732	4"	9"	4" NB	4 3/4" - 5 1/2"	1
D66733	4"	9"	4" PB	4 3/4" - 5 1/2"	1
D66734	4"	9"	5" NB	4 3/4" - 5 5/8"	1
D66735	4"	9"	5" PB	5 1/4" - 6 3/16"	1
D66736	4"	9"	5" CP	4 3/4" - 5 5/8"	1
D66737	4"	9"	6" NB	5" - 6 1/8"	1
D66738	4"	9"	6" PB	5" - 6 1/8"	1
D66739	4"	9"	6" CP	5 3/8" - 6 3/8"	1

4" "Code Blue" No Hub Slab Drain



- No Clamping Ring

3 1/2" Spuds with 4", 5" or 6" Round Strainer

PART NO.	SIZE	PAN	STRAINER	HEIGHT	CTN QTY
D67048	4"	7"	4" NB	3 5/8" - 4 7/8"	1
D67049	4"	7"	4" PB	3 5/8" - 4 7/8"	1
D67050	4"	7"	5" NB	3 5/8" - 4 7/8"	1
D67051	4"	7"	5" PB	4" - 5 3/8"	1
D67052	4"	7"	5" CP	3 1/2" - 4 7/8"	1
D67053	4"	7"	6" NB	3 7/8" - 5 1/16"	1
D67054	4"	7"	6" PB	3 3/4" - 5 1/16"	1
D67055	4"	7"	6" CP	4" - 5 1/2"	1

No Hub Cleanout Bodies



PART NO.	PIPE SIZE	TAP SIZE	HEIGHT	CTN QTY
C37102	2" Body	1-1/2"	2-1/8"	10
C37103	3" Body	2-1/2"	2-1/8"	10
C37104	4" Body	3-1/2"	2-1/8"	10

Plain End Cast Iron Cleanout

Short Pattern Less Plug



• Fits flush with hub

PART NO.	PIPE SIZE	TAP SIZE	HEIGHT	CTN QTY
C37302	2"	1-1/2"	2-3/4"	12
C37303	3"	2-1/2"	3-1/2"	12
C37304	4"	3"	3"	8
C37314	4"	3-1/2"	3"	8

Plain End Cast Iron Cleanout

Long Pattern Less Plug



• Meets ASTM A-74

PART NO.	PIPE SIZE	TAP SIZE	HEIGHT	CTN QTY
C37002	2"	1-1/2"	2-3/4"	12
C37003	3"	2-1/2"	4"	12
C37004	4"	3"	4"	8
C37014	4"	3-1/2"	4"	8
C37005	5"	4"	3-1/2"	4
C37006	6"	5"	4"	2

No Hub Base



• Use with CI strainers or covers for heavy trucking traffic
 • Use with PB, NB, SS or CP strainers or covers for heavy pedestrian traffic

PART NO.	PIPE SIZE	TAP SIZE	HEIGHT	CTN QTY
D63300	3"	3" IPS	4-1/4"	1
D63349	3"	3-1/2 IPS	4-1/4"	1
D63350	4"	3-1/2 IPS	4-1/4"	1
D63400	4"	4" IPS	4-1/4"	1

Gasket Connection Base



• Use with CI strainers or covers for heavy trucking traffic
 • Use with PB, NB or CP strainers or covers for heavy pedestrian traffic
 • Supplied with multi-tite gasket

PART NO.	PIPE SIZE	TAP SIZE	HEIGHT	CTN QTY
D62300	3"	3" IPS	5"	1
D62349	3"	3-1/2" IPS	5-1/4"	1
D62350	4"	3-1/2" IPS	5-1/4"	1
D62400	4"	4" IPS	5-1/4"	1

Cast Iron Spuds w/Covers For Heavy Duty Cleanouts



• For use with heavy duty cleanouts

2-1/2" IPS Brass Plug with Round Cover

PART NO.	SIZE	COVER	CTN QTY
D62230	3"	5" CI	1
D62231	3"	5" NB with ring	1
D62232	3"	5" PB with ring	1

3" IPS Brass Plug with Round Cover

PART NO.	SIZE	COVER	CTN QTY
D62235	3-1/2"	5" CI	1
D62236	3-1/2"	6" NB with ring	1
D62237	3-1/2"	6" PB with ring	1

3-1/2" IPS Brass Plug with Round Cover

PART NO.	SIZE	COVER	CTN QTY
D62240	4"	5" CI	1
D62241	4"	6" NB with ring	1
D62242	4"	6" PB with ring	1

Plastic Spuds w/Covers & Tops for Heavy Duty Cleanouts



- For use with heavy duty cleanouts
- Round cover with 7" top

2-1/2" IPS Brass Plug with Square Top

PART NO.	SIZE	COVER	CTN QTY
D59912	3"	7" PB	1
D59913	3"	7" NB	1

3" IPS Brass Plug with Square Top

PART NO.	SIZE	COVER	CTN QTY
D59910	3-1/2"	7" PB	1
D59911	3-1/2"	7" NB	1

3-1/2" IPS Brass Plug with Square Top

PART NO.	SIZE	COVER	CTN QTY
D59918	4"	7" PB	1
D59919	4"	7" NB	1

Plastic Spuds w/Round Covers for Heavy Duty Cleanouts



- For use with heavy duty cleanouts

2-1/2" IPS Plastic Plug with Round Cover

PART NO.	SIZE	COVER	CTN QTY
D59904	3"	6" PB	1
D59908	3"	6" PB with ring	1
D59905	3"	6" NB	1
D59909	3"	6" NB with ring	1
D59940	3"	6" CI with ring	1

3" IPS Plastic Plug with Round Cover

PART NO.	SIZE	COVER	CTN QTY
D59943	3-1/2"	5" PB	1
D59944	3-1/2"	5" PB with ring	1
D59945	3-1/2"	5" NB	1
D59946	3-1/2"	5" NB with ring	1
D59901	3-1/2"	6" PB	1
D59906	3-1/2"	6" PB with ring	1
D59902	3-1/2"	6" NB	1
D59907	3-1/2"	6" NB with ring	1
D59941	3-1/2"	6" CI with ring	1
D59914	4"	6" PB	1
D59915	4"	6" PB with ring	1
D59916	4"	6" NB	1
D59917	4"	6" NB with ring	1
D59942	4"	6" CI with ring	1

Metal Spuds w/Covers for Heavy Duty Cleanouts



- For use with heavy duty cleanouts

2-1/2" IPS Brass Plug with Round Cover

PART NO.	SIZE	COVER	SCREWS	CENTER X CENTER	CTN QTY
C37803	3"	5" NB	3	3-7/8"	1
C37801	3"	5" PB	3	3-7/8"	1
C37800	3"	5" CP	3	3-7/8"	1

3-1/2" IPS Brass Plug with Round Cover

PART NO.	SIZE	COVER	SCREWS	CENTER X CENTER	CTN QTY
C37810	3-1/2"	5" NB	3	3-7/8"	1
C37811	3-1/2"	5" PB	3	3-7/8"	1
C37805	4"	5" NB	3	3-7/8"	1
C37806	4"	5" PB	3	3-7/8"	1

4" IPS Brass Countersunk Plug with Round Cover

PART NO.	SIZE	COVER	SCREWS	CENTER X CENTER	CTN QTY
C37807	4"	6" NB	2	4-7/8"	1
C37808	4"	6" PB	2	4-7/8"	1

New Orleans Code Brass Plugs



PART NO.	PLUG	O.D.	CTN QTY
P55150	1-1/2"	1-13/16"	25
P55250	2-1/2"	2-3/4"	25
P55300	3"	3-3/8"	25
P55350	3-1/2"	4"	20
P55500	5"	5-1/2"	5

Lead Fit-All Plug



- Cast iron cored
- Sizes are true measurement, not iron pipe size

PART NO.	PLUG	CTN QTY
P56200	2"	12
P56250	2-1/2"	12
P56300	3"	12
P56350	3-1/2"	12
P56400	4"	12
P56450	4-1/2"	12
P56500	5"	12
P56550	5-1/2"	12
P56600	6"	12

Southern Code Brass Plug



PART NO.	PLUG	O.D.	CTN QTY
P50100	1" Raised head	1-9/32"	5
P50125	1- 1/4" Raised head	1-5/8"	5
P50150	1-1/2" Raised head	1-7/8"	5
P51150	1-1/2" Countersunk	1-7/8"	25
P50200	2" Raised head	2-3/8"	5
P51200	2" Countersunk	2-3/8"	25
P50250	2-1/2" Raised head	2-7/8"	20
P51250	2-1/2" Countersunk	2-7/8"	20
P50300	3" Raised head	3-3/8"	20
P51300	3" Countersunk	3-3/8"	20
P50350	3-1/2" Raised head	3-7/8"	20
P51350	3-1/2" Countersunk	3-7/8"	20
P50400	4" Raised head	4-1/2"	15
P51400	4" Countersunk	4-1/2"	15
P50500	5" Raised head	5-1/2"	10
P51500	5" Countersunk	5-1/2"	10
P50600	6" Raised head	6-1/2"	5
P51600	6" Countersunk	6-1/2"	5
P50800	8" Raised head	8-1/2"	5
P51800	8" Countersunk	8-1/2"	5
P50999	10" Raised head	10-5/8"	1

Heavy Pattern Brass Plug



PART NO.	PLUG	O.D.	CTN QTY
P52150	1-1/2" Raised head	1-3/4"	25
P53150	1-1/2" Countersunk	1-3/4"	25
P52200	2" Raised head	2-3/8"	25
P53200	2" Countersunk	2-3/8"	25
P52250	2-1/2" Raised head	2-3/4"	20
P53250	2-1/2" Countersunk	2-3/4"	20
P52300	3" Raised head	3-1/2"	20
P53300	3" Countersunk	3-1/2"	20
P52350	3-1/2" Raised head	3-7/8"	20
P53350	3-1/2" Countersunk	3-7/8"	20
P52400	4" Raised head	4-3/8"	15
P53400	4" Countersunk	4-3/8"	15
P52500	5" Raised head	5-1/2"	10
P53500	5" Countersunk	5-1/2"	10

Code Pattern Plugs



• Meets ASTM A74-98

PART NO.	PLUG	CTN QTY
P59300	3" Raised head	5
P59333	3" Countersunk	5
P59350	3-1/2" Raised head	5
P59355	3-1/2" Countersunk	5
P59400	4" Raised head	5
P59444	4" Countersunk	5

Slotted Brass Plug With 1/4" Tap



• Tap is not through the plug

PART NO.	PLUG	CTN QTY
P58150	1-1/2"	10
P58200	2"	10
P58250	2-1/2"	10
P58300	3"	10
P58350	3-1/2"	10
P58400	4"	10

Brass Plug For Extension Cover

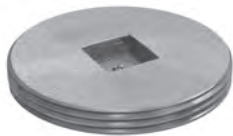

•Countersunk plug tapped 1/4-20

PART NO.	PLUG	O.D.	CTN QTY
P54150	1-1/2"	1-7/8"	10
P54200	2"	2-3/8"	10
P54250	2-1/2"	2-7/8"	10
P54300	3"	3-3/8"	10
P54350	3-1/2"	3-7/8"	10
P54400	4"	4-1/2"	10
P54500	5"	5-1/2"	5
P54600	6"	6-1/2"	5
P54800	8"	8-1/2"	5

Extension Cover Set



• Set includes stainless steel extension cover, brass countersunk plug and 1/4- 20 x 4" flat head machine screws
* Contains slotted plug

Wall Covers (24 gauge)

PART NO.	PLUG	COVER	CTN QTY
C92150	1-1/2"	3"	10
C92151*	1-1/2" slotted	3"	10
C92200	2"	4"	10
C92202*	2" slotted	4"	10
C92250	2-1/2"	5"	10
C92252*	2-1/2" slotted	5"	10
C92300	3"	5"	10
C92301	3"	6"	10
C92303*	3" slotted	6"	10
C92350	3-1/2"	6"	10
C92351	3-1/2"	7"	10
C92353*	3-1/2" slotted	7"	10
C92400	4"	7"	10
C92404*	4" slotted	7"	10
C92500	5"	8"	10
C92600	6"	8"	5
C92601	6"	10"	5
C92800	8"	10"	5

Floor Covers (16 gauge)

PART NO.	PLUG	COVER	CTN QTY
C93150	1-1/2"	3"	10
C93200	2"	4"	10
C93250	2-1/2"	5"	10
C93300	3"	5"	10
C93301	3"	6"	10
C93350	3-1/2"	6"	10
C93351	3-1/2"	7"	10
C93400	4"	7"	10
C93500	5"	8"	10

Stainless Steel Cleanout/ Extension Covers



Wall Mount (24 gauge)

PART NO.	SIZE	CTN QTY
C90300	3"	25
C90400	4"	25
C90500	5"	25
C90600	6"	25
C90700	7"	10
C90800	8"	10
C90999	10"	10

Floor Mount (16 gauge)

PART NO.	SIZE	CTN QTY
C91300	3"	25
C91400	4"	25
C91500	5"	25
C91600	6"	25
C91700	7"	10
C91800	8"	10
C91999	10"	10

Wall Mount With 4" Bolt (24 gauge)

PART NO.	SIZE	CTN QTY
C90013	3"	25
C90014	4"	25
C90015	5"	25
C90016	6"	25
C90017	7"	10
C90018	8"	10
C90019	10"	10

Floor Mount With 4" Bolt (16 gauge)

PART NO.	SIZE	CTN QTY
C91013	3"	25
C91014	4"	25
C91015	5"	25
C91016	6"	25
C91017	7"	10
C91018	8"	10
C91019	10"	10

Bolts For Extension/Cleanout Covers



• Flat slotted head plated machine screw

PART NO.	SIZE	CTN QTY
C90002	1/4"- 20 x 2-1/2"	100
C90004	1/4"- 20 x 4"	100
C90006	1/4"- 20 x 6"	50

High Impact Plastic Cleanout Cover Plates



- Polished chrome or white matte finish
- Individually bagged with # 14 wood screw included

Flat Design

PART NO.	SIZE	CTN QTY
C94004	4-1/4" Chrome finish	25
C94005	5-1/4" Chrome finish	25
C94007	7-1/4" Chrome finish	25
C94009	9-1/4" Chrome finish	10
C95004	4-1/4" White finish	25
C95005	5-1/4" White finish	25
C95007	7-1/4" White finish	25
C95009	9-1/4" White finish	10

Bell Design

PART NO.	SIZE	CTN QTY
C96004	4-1/4" Chrome finish	25
C96005	5-1/4" Chrome finish	25
C96007	7-1/4" Chrome finish	25
C96009	9-1/4" Chrome finish	10
C97004	4-1/4" White finish	25
C97005	5-1/4" White finish	25
C97007	7-1/4" White finish	25
C97009	9-1/4" White finish	10

Trap Covers



• Stainless steel

PART NO.	DESCRIPTION	CTN QTY
C98001	5-3/4" Flat SS trap cover	1
C98002	5-3/4" Raised SS trap cover	1

Stainless Steel Dome Cover Plates



- High grade stainless steel
- Individually bagged with # 14 wood screw and 1/4" x 2-1/2" machine screw

PART NO.	DESCRIPTION	CTN QTY
C98014	4" SS dome cover plate	1
C98016	6" SS dome cover plate	1
C98018	8" SS dome cover plate	1

Push-On Cleanout



- Meets ASTM A74-98 and ASME A112.36.2M-91
- Cut pipe to desired level, lube gasket and push-on pipe, tap with lead hammer to seat, then install plug
- Schedule 40 unit fits plastic and extra heavy cast iron pipe

Less Gasket

PART NO.	PIPE SIZE	PLUG	HEIGHT	CTN QTY
C36003	3" SV	Raised head	3"	8
C36013	3" SV	Countersunk	3"	8
C36004	4" SV	Raised head	3"	8
C36014	4" SV	Countersunk	3"	8
C36024	4" Sch.40	Raised head	3"	8
C36034	4" Sch.40	Countersunk	3"	8
C36006	6" SV	Raised head	2-3/4"	4
C36016	6" SV	Countersunk	2-3/4"	4

With Gasket

PART NO.	PIPE SIZE	PLUG	HEIGHT	CTN QTY
C36104	4" SV	Raised head	3-1/4"	8
C36114	4" SV	Countersunk	3-1/4"	8
C36124	4" Sch.40	Raised head	3-1/4"	8
C36134	4" Sch.40	Countersunk	3-1/4"	8
C36106	6" SV	Raised head	3"	4
C36116	6" SV	Countersunk	3"	4

No Hub Cleanout With Plug



Southern Code Plug

PART NO.	PIPE SIZE	PLUG	HEIGHT	CTN QTY
C38402	2"	1-1/2" Raised Head	2-1/8"	10
C39402	2"	1-1/2" Countersunk	2-1/8"	10
C38403	3"	2-1/2" Raised Head	2-1/8"	10
C39403	3"	2-1/2" Countersunk	2-1/8"	10
C38404	4"	3-1/2" Raised Head	2-1/8"	10
C39404	4"	3-1/2" Countersunk	2-1/8"	10

Heavy Plug

PART NO.	PIPE SIZE	PLUG	HEIGHT	CTN QTY
C38502	2"	1-1/2" Raised Head	2-1/8"	10
C39502	2"	1-1/2" Countersunk	2-1/8"	10
C38503	3"	2-1/2" Raised Head	2-1/8"	10
C39503	3"	2-1/2" Countersunk	2-1/8"	10
C38504	4"	3-1/2" Raised Head	2-1/8"	10
C39504	4"	3-1/2" Countersunk	2-1/8"	10

New Orleans Code Plug

PART NO.	PIPE SIZE	PLUG	HEIGHT	CTN QTY
C40102	2"	1-1/2" Plug	2-1/4"	10
C40103	3"	2-1/2" Plug	2-1/4"	10
C40104	4"	3-1/2" Plug	2-1/4"	10

Plain End Cast Iron Cleanout-Short Pattern with Southern Code Plug



- Fits flush with hub

PART NO.	PIPE SIZE	PLUG	HEIGHT	CTN QTY
C38102	2"	1-1/2" Raised head	2-7/8"	10
C39102	2"	1-1/2" Countersunk	2-7/8"	10
C38103	3"	2-1/2" Raised head	3-5/8"	10
C39103	3"	2-1/2" Countersunk	3-5/8"	10
C38104	4"	3" Raised head	3"	10
C39104	4"	3" Countersunk	3"	10
C38114	4"	3-1/2" Raised head	3"	10
C39114	4"	3-1/2" Countersunk	3"	10

Plain End Cleanout Long Pattern



- For use with service weight (caulk into hub) or no-hub (use coupling)

With Southern Code Plug

PART NO.	PIPE SIZE	PLUG	HEIGHT	CTN QTY
C38002	2"	1-1/2" Raised (low sq.)	3-1/4"	12
C39002	2"	1-1/2" Countersunk	3-1/4"	12
C38003	3"	2-1/2" Raised (low sq.)	4"	12
C39003	3"	2-1/2" Countersunk	4"	12
C38004	4"	3" Raised head (low sq.)	4"	8
C39004	4"	3" Countersunk	4"	8
C38014	4"	3-1/2" Raised (low sq.)	4"	8
C39014	4"	3-1/2" Countersunk	4"	8
C38005	5"	4" Raised head (low sq.)	3-1/2"	4
C39005	5"	4" Countersunk	3-1/2"	4
C38006	6"	5" Raised head (low sq.)	4"	2
C39006	6"	5" Countersunk	4"	2

With Heavy Pattern Plug

PART NO.	PIPE SIZE	PLUG	HEIGHT	CTN QTY
C38202	2"	1-1/2" Raised head (hex)	3-1/4"	12
C39202	2"	1-1/2" Countersunk	3-1/4"	12
C38203	3"	2-1/2" Raised head (hex)	4"	12
C39203	3"	2-1/2" Countersunk	4"	12
C38204	4"	3" Raised head (hex)	4"	8
C39204	4"	3" Countersunk	4"	8
C38214	4"	3-1/2" Raised head (hex)	4"	8
C39214	4"	3-1/2" Countersunk	4"	8
C38205	5"	4" Raised head (hex)	3-1/2"	4
C39205	5"	4" Countersunk	3-1/2"	4
C38206	6"	5" Raised head (hex)	4"	2
C39206	6"	5" Countersunk	4"	2

Cleanout Ferrule With New Orleans Code Plug



Service Weight

PART NO.	PIPE SIZE	PLUG	HEIGHT	CTN QTY
C40002	2" SV	1-1/2"	3"	12
C40003	3" SV	2-1/2"	4"	12
C40004	4" SV	3 1/2"	4"	8
C40006	6" SV	5"	4"	2

Plumb Lock Adjustable Cleanout



- Supplied with Multi-Tite gasket
- Similar to Zurn Neo-Loc line

3" Spud with 3" Gasket Connection

PART NO.	PIPE SIZE	COVER	BODY HEIGHT	ADJ. HEIGHT	CTN QTY
D62330	3"	5" CI	5-1/4"	5-7/8" - 7"	1
D62333	3"	5" NB	5-1/4"	5-7/8" - 7"	1
D62334	3"	5" PB	5-1/4"	5-7/8" - 7"	1
D62335	3"	5" CP	5-1/4"	5-7/8" - 7"	1

4" Spud with 4" Gasket Connection

PART NO.	PIPE SIZE	COVER	BODY HEIGHT	ADJ. HEIGHT	CTN QTY
D62433	4"	5" NB	5-1/2"	6-1/8" - 7-1/4"	1
D62434	4"	5" PB	5-1/2"	6-1/8" - 7-1/4"	1
D62443	4"	5" NB w/4" plug	5-1/2"	6-1/8" - 7-1/4"	1
D62444	4"	5" PB w/4" plug	5-1/2"	6-1/8" - 7-1/4"	1

4" Spud with 6" Gasket Connection

PART NO.	PIPE SIZE	COVER	BODY HEIGHT	ADJ. HEIGHT	CTN QTY
D62601	6"	5" NB	3-1/4"	3-5/8" - 4-3/4"	1
D62602	6"	5" PB	3-1/4"	3-5/8" - 4-3/4"	1

No Hub Adjustable Cleanout



3" Spud

PART NO.	PIPE SIZE	COVER	BODY HEIGHT	ADJ. HEIGHT	CTN QTY
D63330	3"	5" CI	4 1/4"	4 7/8" - 6"	1
D63333	3"	5" NB	4 1/4"	4 7/8" - 6"	1
D63334	3"	5" PB	4 1/4"	4 7/8" - 6"	1
D63335	3"	5" CP	4 1/4"	4 7/8" - 6"	1

4" Spud

PART NO.	PIPE SIZE	COVER	BODY HEIGHT	ADJ. HEIGHT	CTN QTY
D63433	4"	5" NB	4 1/4"	4 7/8" - 6"	1
D63434	4"	5" PB	4 1/4"	4 7/8" - 6"	1

Adjustable- Plain End



- Cast iron top is for forklift or heavy trucking traffic
- Nickel bronze and polished brass tops are for heavy pedestrian traffic
- Satin finish on nickel bronze and polished brass ring and cover
- Cleanout body with brass plug
- Can also be caulked into hub

PART NO.	PIPE SIZE	COVER	ADJ. HEIGHT	CTN QTY
C33021	2"	5 1/4" CI w/ center screw	3 1/8" - 4 1/4"	1
C33022	2"	5 1/2" NB with ring	3" - 4 3/4"	1
C33023	2"	5 1/2" PB with ring	3" - 4 3/4"	1
C33031	3"	5 1/4" CI w/ center screw	4" - 5 3/4"	1
C33032	3"	5 1/2" NB with ring	4 1/4" - 6"	1
C33033	3"	5 1/2" PB with ring	4 1/4" - 6"	1
C33044	4"	6 3/16" CI w/ center screw	5 1/8" - 6 1/8"	1
C33045	4"	6 1/2" NB with ring	5 3/8" - 6 3/8"	1
C33046	4"	6 1/2" PB with ring	5 3/8" - 6 3/8"	1

Adjustable Push-On Cast Iron Pipe



- Supplied with gasket for cast iron pipe
- Cast iron top is for forklift or heavy trucking traffic
- Nickel bronze and polished brass tops are for heavy pedestrian traffic
- Cleanout body with brass plug

PART NO.	PIPE SIZE	COVER	ADJ. HEIGHT	CTN QTY
C33121	3"	5 1/4" CI w/ center screw	3 7/8" - 4 3/4"	1
C33122	3"	5 1/2" NB with ring	4 1/8" - 5"	1
C33123	3"	5 1/2" PB with ring	4 1/8" - 5"	1
C33144	4"	6 3/16" CI w/ center screw	4 7/8" - 5 3/4"	1
C33145	4"	6 1/2" NB with ring	5" - 6"	1
C33146	4"	6 1/2" PB with ring	5" - 6"	1

Adjustable Plastic Pipe Fit



- Cast iron top is for forklift or heavy trucking traffic
- Nickel bronze and polished brass tops are for heavy pedestrian traffic
- Satin finish on nickel bronze and polished brass ring and cover
- Cleanout body with plastic plug

PART NO.	HEIGHT ADJUSTMENT
C33221	2-7/8" – 3-7/8"
C33222	3-1/8" – 4-1/8"
C33223	3-1/8" – 4-1/8"
C33231	4" – 5"
C33232	4-1/4" – 5-1/4"
C33233	4-1/4" – 5-1/4"
C33244	5-1/8" – 6-1/4"
C33245	5-3/8" – 6-1/2"
C33246	5-3/8" – 6-1/2"

PART NO.	HEIGHT ADJUSTMENT
C33321	2-7/8" – 3-7/8"
C33322	3-1/8" – 4-1/8"
C33323	3-1/8" – 4-1/8"
C33331	4" – 5"
C33332	4-1/4" – 5-1/4"
C33333	4-1/4" – 5-1/4"
C33344	5-1/8" – 6-1/4"
C33345	5-3/8" – 6-1/2"
C33346	5-3/8" – 6-1/2"

PART NO.	SIZE	COVER	MATERIAL	CTN QTY
C33221	2"	5-1/4" CI w/ center screw	PVC	1
C33321	2"	5-1/4" CI w/ center screw	ABS	1
C33222	2"	5-1/2" NB with ring	PVC	1
C33322	2"	5-1/2" NB with ring	ABS	1
C33223	2"	5-1/2" PB with ring	PVC	1
C33323	2"	5-1/2" PB with ring	ABS	1
C33231	3"	5-1/4" CI w/ center screw	PVC	1
C33331	3"	5-1/4" CI w/ center screw	ABS	1
C33232	3"	5-1/2" NB with ring	PVC	1
C33332	3"	5-1/2" NB with ring	ABS	1
C33233	3"	5-1/2" PB with ring	PVC	1
C33333	3"	5-1/2" PB with ring	ABS	1
C33244	4"	6-3/16" CI w/ center screw	PVC	1
C33344	4"	6-3/16" CI w/ center screw	ABS	1
C33245	4"	6-1/2" NB with ring	PVC	1
C33345	4"	6-1/2" NB with ring	ABS	1
C33246	4"	6-1/2" PB with ring	PVC	1
C33346	4"	6-1/2" PB with ring	ABS	1

Adjustable Plastic Pipe Hub Fit



- Cast iron top is for forklift or heavy trucking traffic
- Nickel bronze and polished brass tops are for heavy pedestrian traffic
- Satin finish on nickel bronze and polished brass ring and cover
- Cleanout body with plastic plug

PART NO.	HEIGHT ADJUSTMENT
C33444	3" – 4-1/2"
C33445	3-1/4" – 4-3/4"
C33446	3-1/4" – 4-3/4"

PART NO.	HEIGHT ADJUSTMENT
C33544	3" – 4-1/2"
C33545	3-1/4" – 4-3/4"
C33546	3-1/4" – 4-3/4"

PART NO.	SIZE	COVER	MATERIAL	CTN QTY
C33444	4"	6-3/16" CI w/ center screw	PVC	1
C33544	4"	6-3/16" CI w/ center screw	ABS	1
C33445	4"	6-3/16" NB with ring	PVC	1
C33545	4"	6-3/16" NB with ring	ABS	1
C33446	4"	6-3/16" PB with ring	PVC	1
C33546	4"	6-3/16" PB with ring	ABS	1

Adjustable Access Cover



- Cast iron top is for forklift or heavy trucking traffic
- Designed to fit over 2", 3" and 4" plastic adapter, cast iron cleanout, ferrules and various drainage piping (2" x 3" fits 2" and 3" bodies)
- 3 set screws allow for vertical adjustment
- Nickel bronze and polished brass are satin finish

PART NO.	PIPE SIZE	COVER	HEIGHT	INSIDE C.O.	CTN QTY
C33001	2" & 3"	5-1/4" CI w/ center screw	2-1/8"	4-9/16"	1
C33002	2" & 3"	5-1/2" NB with ring	2-1/8"	4-9/16"	1
C33003	2" & 3"	5-1/2" PB with ring	2-1/8"	4-9/16"	1
C33004	4"	6-3/16" CI w/ center screw	2-5/8"	5-5/16"	1
C33005	4"	6-1/2" NB with ring	2-5/8"	5-5/16"	1
C33006	4"	6-1/2" PB with ring	2-5/8"	5-5/16"	1

Heavy Duty Cleanout



- Scoriated cover
- Fits any 6" pipe
- 3 bolts secure the cleanout while curing concrete

PART NO.	PIPE SIZE	DESCRIPTION	HEIGHT	INSIDE C.O.	CTN QTY
D76005	6"	HDuty CI cleanout	5-3/8"	6-3/4"	1

Adjustable Floor Cleanout



- Adjusts 2-1/2"
- 4" cast iron body

PART NO.	PIPE SIZE	DESCRIPTION	HEIGHT	INSIDE C.O.	CTN QTY
A40001	4"	5" CP	5-1/4"	3-3/4"	1
A40002	4"	5" PB	5-1/4"	3-3/4"	1
A40003	4"	5" NB	5-1/4"	3-3/4"	1

Roof Drain with Cast Iron Dome



- 10" diameter pan
- Dome has 50 sq. Inches of drain area
- Cast iron dome

PART NO.	SIZE	PAN	DOMES	HEIGHT	CTN QTY
R19003	3" Inside caulk	10"	5-1/2"	8"	1
R19005	3" No Hub	10"	5-1/2"	8"	1
R19004	4" Inside caulk	10"	5-1/2"	8"	1
R19006	4" No Hub	10"	5-1/2"	8"	1
R18020	Cast iron roof dome		5-1/2"		1

"Code Blue" No Caulk (Mechanical Joint) Roof Drain with Square Pan



- 8 1/2" square pan
- Cast Iron dome and drain
- Supplied with stainless steel bolts

PART NO.	SIZE	STRAINER	HEIGHT	CTN QTY
R19102	2" No Caulk	8-1/2"	9-1/2"	1
R19103	3" No Caulk	8-1/2"	9-1/2"	1
R19104	4" No Caulk	8-1/2"	9-1/2"	1

"Code Blue" No Hub Side Outlet Roof Drain



PART NO.	SIZE	PAN	HEIGHT	CTN QTY
R19402	2"	8-1/2"	9-1/2"	1
R19403	3"	8-1/2"	9-1/2"	1
R19404	4"	8-1/2"	9-1/2"	1

"Code Blue" No Hub Roof Drain with Square Pan



- 8 1/2" square pan
- Cast Iron dome and drain
- Supplied with stainless steel bolts

PART NO.	SIZE	PAN	HEIGHT	CTN QTY
R19202	2" No Hub	8-1/2"	9-1/2"	1
R19203	3" No Hub	8-1/2"	9-3/4"	1
R19204	4" No Hub	8-1/2"	9-3/4"	1
R19206	6" No Hub	8-1/2"	9-3/4"	1

"Code Blue" No Hub Dual Roof Drains



- Supplied with stainless steel bolts

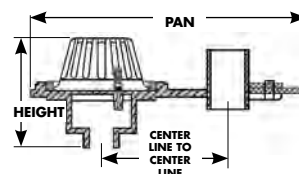

PIPE SIZE	CENTER TO CENTER	PAN	OVERALL SINGLE	HEIGHT DOUBLE
2"	8-1/2"	19"	8"	8-1/2"
3"	8-1/2"	19"	9-1/2"	10"
4"	8-1/2"	19"	10"	10-1/2"

Single Dome

PART NO.	SIZE	PAN	CTN QTY
R19302	2" No hub dual drain	19"	1
R19303	3" No hub dual drain	19"	1
R19304	4" No hub dual drain	19"	1

Double Dome

PART NO.	SIZE	PAN	CTN QTY
R19307	2" No hub dual dome drain	19"	1
R19305	3" No hub dual dome drain	19"	1
R19306	4" No hub dual dome drain	19"	1

Replacement Parts

PART NO.	SIZE	CTN QTY
R19099	Roof drain dome	1
R19100	Clamping ring	1

Area Drain



- Full waterway
- Lip secures strainer

DRAIN SPECS

SIZE	TOP WIDTH	OVERALL HEIGHT
2"	4-7/8"	3-1/4"
3"	6-3/16"	3-1/4"
4"	7-3/16"	3-1/4"

STRAINER SPECS

SIZE	A	B
2"	4-1/4"	4-1/4"
3"	5-3/8"	5-5/8"
4"	6-11/16"	6-11/16"

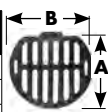

PART NO.	DESCRIPTION	CTN QTY
D76002	2" Inside caulk drain	8
D77002	2" No hub drain	8
D76012	2" Inside caulk CP area drain with strainer	8
D76092	2" Strainer only	1
D76003	3" No hub drain	4
D77003	3" No hub drain	4
D76013	3" Inside caulk CP area drain with strainer	4
D76093	3" Strainer only	1
D76004	4" Inside caulk drain	4
D77004	4" No hub drain	4
D76014	4" Inside caulk CP area drain with strainer	4
D76094	4" Strainer only	1

St. Louis Drain



- Heavy duty loose set strainer
- Inside caulk

PART NO.	SIZE	CTN QTY
C72002	2" Inside caulk	8
C72003	3" Inside caulk	4
C72004	4" Inside caulk	2
C72093	6-3/4" OD Strainer	1

Inside Caulk Shower Stall Drains



- Designed for prefab shower stalls
- Snap in stainless steel strainer
- Fits 2" Schedule 40 and cast iron pipe
- Can be adapted to no-caulk with gasket
- 4 1/4" OD strainer

PART NO.	SIZE	STRAINER	CTN QTY
D40102	2"	SS	20
D40202	2"	PB	20
D60101	Gaskets to make unit no caulk		1

Cast Iron Gasket Connection Drain



- Supplied with Multi-Tite gasket
- Just lube gasket and push over S.V. or N.H. cast iron pipe
- NB and PB are for heavy pedestrian traffic areas

PART NO.	SIZE	STRAINER	CTN QTY
D62950	3"	5" NB with ring	1
D62951	3"	5" PB with ring	1
D62952	3"	4" CI	1
D62960	4"	6" NB with ring	1
D62961	4"	6" PB with ring	1
D62962	4"	5" CI	1

IPS Shower Stall Drain



- Designed for prefab shower stalls
- Snap in stainless steel strainer
- 4 1/4" O.D. strainer

PART NO.	SIZE	STRAINER	CTN QTY
D40104	1 1/2"	SS	20
D40204	1 1/2"	PB	20
D40103	2"	SS	20
D40203	2"	PB	20

Female Iron Pipe Shower Drain



- Cast brass body
- Stainless steel strainer

PART NO.	SIZE	BODY	STRAINER	CTN QTY
D40150	1 1/2"	Cast brass	SS	12
D40200	2"	Cast brass	SS	12

Kentucky Drain



- Inside caulk

PART NO.	DESCRIPTION	CTN QTY
C73003	3" Inside caulk drain	4
C73093	3" Strainer only	1
C73192	3" Drain with 2" hole in strainer	4
C73193	3" Strainer only with 2" hole	1
C73004	4" Inside caulk drain	4
C73094	4" Strainer only	1

Brass Inside Caulk Floor Drain



- For use where pan liner is not required
- Brass body

PART NO.	SIZE	BODY	STRAINER	CTN QTY
D76601	2"	Brass	SS	1

Combination Drain Trap



- Bolt-down clamping collar
- Weep holes and grooves in clamping flange

PART NO.	SIZE	STRAINER	CTN QTY
J60060	2" IPS	4" SS	1
J60061	2" IPS	4" CP brass	1
J60062	2" IPS	4" PB	1

Urinal Drain



- Brass body with stainless steel strainer

PART NO.	SIZE	BODY	STRAINER	CTN QTY
D45002	2" IPS	Brass	SS	1

Urinal Drain Flange Kit



- Kit includes all necessary hardware

PART NO.	DESCRIPTION	CTN QTY
F10005	2" IPS x 4-1/4"	1

Floor Drain With Trap



- Throat of drain is threaded for backwater device D70-500

Concealed Cleanout

PART NO.	DESCRIPTION	CTN QTY
D70001	2" Drain	1
D70011	2" Drain with backwater device	1
D70098	6 3/8" Cast iron strainer	1

Exposed Cleanout

D70020	2" Drain with backwater device	1
D70022	2" Drain with 1/2" PT	1
D71103	3" Drain - Backwater device not compatible	1
D70021	2" Drain with backwater device	1

Backwater Device



- Sleeve type
- Ball included

PART NO.	DESCRIPTION	CTN QTY
D70500	2" MIP brass body	1
B06001	2" MIP plastic body	1
B70499	2" Plastic ball	1

Des Moines Pattern Floor Drain



- Bolt down lid
- Integral trap

PART NO.	DESCRIPTION	CTN QTY
D71003	3" with trap	1
D71004	Strainer for Des Moines	1

Inside Caulk Bell Trap



- Hinged lid
- Bell attached

PIPE SIZE	BODY	STRAINER	OUTLET HEIGHT	OVERALL HEIGHT
2"	6" x 6"	4-7/8"	1-3/4"	4-1/8"
3"	9" x 9"	6-3/4"	1-7/8"	4-7/8"
4"	12" x 12"	9-3/4"	1-3/4"	4-7/8"

PART NO.	SIZE	CTN QTY
D76202	6" x 6" x 2"	1
D76203	9" x 9" x 3"	1
D76204	12" x 12" x 4"	1

Strainers Less Hinge

PART NO.	SIZE	CTN QTY
D76205L	4-7/8" strainer for 6" x 6"	20
D76207L	6-3/4" strainer for 9" x 9"	20
D76209L	9-3/4" strainer for 12" x 12"	10

Cast Iron Bell With Nut And Bolt

PART NO.	SIZE	CTN QTY
D76256	Bell for 6" x 6"	20
D76259	Bell for 9" x 9"	20
D76252	Bell for 12" x 12"	10

Spigot Outlet Bell Trap



- Loose lid
- Bell cast on

PIPE SIZE	BODY	STRAINER	OUTLET HEIGHT	OVERALL HEIGHT
2"	6" x 6"	4-7/8"	1-3/8"	3-1/2"
3"	9" x 9"	6-3/4"	1-1/2"	4-1/2"
4"	12" x 12"	9-3/4"	1-1/2"	4-7/8"

PART NO.	SIZE	CTN QTY
D76402	6" x 6" x 2"	1
D76403	9" x 9" x 3"	1
D76404	12" x 12" x 4"	1

Replacement Strainer With Cast-In Bell

PART NO.	SIZE	CTN QTY
D76412	4-7/8" cast-in bell for 6" x 6"	20
D76413	6-3/4" cast-in bell for 9" x 9"	20
D76414	9-3/4" cast-in bell for 12" x 12"	10

No Hub Bell Trap



- Spigot outlet
- Hinged lid
- Bell attached

PIPE SIZE	BODY	STRAINER	OUTLET HEIGHT	OVERALL HEIGHT
2"	6" x 6"	4-7/8"	1-1/4"	3-1/4"
3"	9" x 9"	6-3/4"	1-1/2"	4-1/4"
4"	12" x 12"	9-3/4"	1-1/2"	4-7/8"

PART NO.	SIZE	CTN QTY
D76302	6" x 6" x 2"	1
D76303	9" x 9" x 3"	1
D76304	12" x 12" x 4"	1

Strainers Less Hinge

PART NO.	SIZE	CTN QTY
D76205L	4-7/8" strainer for 6" x 6"	20
D76207L	6-3/4" strainer for 9" x 9"	20
D76209L	9-3/4" strainer for 12" x 12"	10

Cast Iron Bell With Nut And Bolt

PART NO.	SIZE	CTN QTY
D76256	Bell for 6" x 6"	20
D76259	Bell for 9" x 9"	20
D76252	Bell for 12" x 12"	10

Pittsburgh Bell Trap



- Deep body
- 4" inside caulk

PIPE SIZE	BODY	STRAINER	OVERALL HEIGHT
4"	9" x 9"	6-3/4"	4-1/2"

PART NO.	SIZE	CTN QTY
B60994	9" x 9" x 4" Inside caulk less bell	1

Strainer Only (Loose Lid)

PART NO.	SIZE	CTN QTY
B60099	6-3/4" ID strainer	1

Heavy Duty Floor Drain



- 8-1/2" heavy duty cast iron grate
- Cast iron sediment bucket

No Hub Less Sediment Bucket					
PART NO.	SIZE	PAN	GRATE	HEIGHT	CTN QTY
D79703	3"	10-1/2"	9" CI	5 1/4"	1
D79704	4"	10-1/2"	9" CI	5 1/4"	1

No Hub With Sediment Bucket					
PART NO.	SIZE	PAN	GRATE	HEIGHT	CTN QTY
D79705	3"	10-1/2"	9" CI	5 1/4"	1
D79706	4"	10-1/2"	9" CI	5 1/4"	1

Inside Caulk Less Sediment Bucket					
PART NO.	SIZE	PAN	GRATE	HEIGHT	CTN QTY
D79805	3"	10-1/2"	9"CI	5 1/4"	1
D79806	4"	10-1/2"	9"CI	5 1/4"	1

Inside Caulk With Sediment Bucket					
PART NO.	SIZE	PAN	GRATE	HEIGHT	CTN QTY
D79803	3"	10-1/2"	9"CI	5 1/4"	1
D79804	4"	10-1/2"	9"CI	5 1/4"	1

Sediment Bucket		
PART NO.	DESCRIPTION	CTN QTY
D50095	CI sediment bucket	1

"Code Blue" No Caulk (Mechanical Joint) Cesspool Drain



- Supplied with stainless steel bolts
- Includes test plug



PART NO.	SIZE	STRAINER	HEIGHT	CTN QTY
D76702	2"	6" CI	4 1/16"	1
D76703	3"	7" CI	4 1/16"	1
D76704	4"	8" CI	4 1/16"	1

"Code Blue" No Caulk (Mechanical Joint) Cesspool Drain Grate



PART NO.	DESCRIPTION	CTN QTY
D76705	Grate for D76-702	1
D76706	Grate for D76-703	1
D76707	Grate for D76-704	1

Caulk Cesspool with Recessed Grate



PART NO.	DESCRIPTION	CTN QTY
D76504	12" x 12" x 4"	1
D76519	Grate only	1

Rainleader Cesspool



- For areas requiring downspout, rainleader and cesspool drain
- Grate secured by screw
- 12-3/4" diameter pan fits over outlet

PART NO.	DESCRIPTION	CTN QTY
J60030	4" hub inlet x 4" spigot outlet	1

Square Cesspool Grate



PART NO.	DESCRIPTION	CTN QTY
D59156	6" x 6" square grate	10
D59158	8" x 8" square grate	5
D59160	10" x 10" square grate	2
D59162	12" x 12" square grate	2

Round Slop Sink, Hydrant Cesspool



- 2" IPS outlet
- Removable Strainer

PART NO.	DESCRIPTION	CTN QTY
S55100	2" IPS ink painted	1
S55101	2" IPS galvanized cast iron	1

Square Hydrant Cesspool



- Grate included
- Spigot outlet

PART NO.	DESCRIPTION	CTN QTY
S57034	11" x 11" x 4"	1
S57035	Grate only	1

Porcelain Coated Floor Sinks



- 12"x 12" white porcelain coated cast iron
- No hub and inside caulk
- Aluminum dome bottom strainer included

PART NO.	DESCRIPTION	CTN QTY
S55104	4" Inside caulk 6" deep	1
S55004	4" Inside caulk 8" deep	1
S55112	2" No hub 6" deep	1
S55113	3" No hub 6" deep	1
S55114	4" No hub 6" deep	1

Top Grates Only To Fit Floor Sinks



PART NO.	DESCRIPTION	CTN QTY
S55010	Full top grate	1
S55075	Three-quarter grate	1
S55050	Half grate	1

Aluminum Bottom Dome For Cast Iron Sink



- Fits all sizes porcelain coated cast iron sinks

BOTTOM OD	HEIGHT
5-3/8"	2-1/4"

PART NO.	DESCRIPTION	CTN QTY
S55115	Aluminum bottom dome- Fit All	10
S60002	2" Aluminum bottom dome	10
S60003	3" Aluminum bottom dome	10
S60004	4" Aluminum bottom dome	10

Plumlock Porcelain Floor Sink



- 12"x 12" white porcelain coated cast iron
- Aluminum dome strainer included
- Push-On Connection; gasket supplied

PART NO.	DESCRIPTION	CTN QTY
S55122	2" Plumlock Floor Sink- 6" deep	1
S55123	3" Plumlock Floor Sink- 6" deep	1
S55124	4" Plumlock Floor Sink- 6" deep	1

Plumlock Gasket For Cast Iron Or Schedule 40 Pipe Connectors



- Fits 12" x 12" white porcelain coated cast iron Plumlock Sinks

PART NO.	DESCRIPTION	CTN QTY
S55192	2" PlumLock Gasket	1
S55193	3" PlumLock Gasket	1
S55194	4" PlumLock Gasket	1

Service Sink Faucets



- Integral stops
- Integrated vacuum breaker
- Complete with all mounting hardware
- Meets ASSE 1001
- Front hook to hang bucket

PART NO.	DESCRIPTION	CTN QTY
S55349	Service sink faucet with lever handles	1
S55350	Service sink faucet w/cross handles	1
S55351	Cross handle stem repair kit for S55-350	1
S55352	Lever handle stem repair kit for S55-349	1
S55353	Integral stop repair kit for S55-349	1
S55354	Vacuum breaker repair kit (S5-349 or S55-350)	1

Trap Standard



- Cast iron body with white coating
- Chrome-plated brass strainer
- Fits American Standard, Kohler, Eljer and Crane cast iron service sinks

PART NO.	DESCRIPTION	CTN QTY
T00002	2" IPS	1
T00003	3" IPS	1
T00005	Base plated for trap standard	1
T00006	1-1/2" N.O. plug with gasket	1
T00007	Trap standard nipple with locknut	1
T00009	Strainer and stud for trap standard	1

Mop Service Basin



- One-piece molded construction; 24" x 24" x 10"
- Crushed stone with polyester resin
- Supplied with 3" gasketed connection and stainless steel strainer

PART NO.	DESCRIPTION	CTN QTY
S55240	Mop service basin	1

Hose and Bracket for Service Sink



- Heavy duty 300# cloth-reinforced hose
- 5" x 3" stainless steel bracket with rubber grip
- 3/4" brass hose coupling at one end

PART NO.	DESCRIPTION	CTN QTY
M05001	Hose with bracket	1/5

Mop Hanger for Service Sink



- 24" x 3" stainless steel hanger with three rubber tool grips
- Anchors included

PART NO.	DESCRIPTION	CTN QTY
M05003	Mop hanger	1/5

Bar Grate



• For hub openings in soil pipe

Less Legs

PART NO.	SIZE	DIAMETER	CTN QTY
D59102	2"	2-3/4"	10
D59103	3"	3-3/4"	10
D59104	4"	4-7/8"	10
D59106	6"	6-7/8"	10
D59101	4"	4-7/8"	10

With Legs

PART NO.	SIZE	DIAMETER	CTN QTY
D59112	2"	2-3/4"	10
D59113	3"	3-3/4"	10
D59114	4"	4-7/8"	10

Perforated Sewer Strainer with Legs



• For hub openings in clay sewer pipe

PART NO.	SIZE	DIAMETER	CTN QTY
D59124	4"	5-1/2"	10
D59126	6"	7-3/8"	5
D59128	8"	10-1/8"	5
D59130	10"	12-1/4"	2
D59132	12"	14-1/4"	2

Sewer Box



• Sewer lid is marked "sewer"
• Water lid is marked "water"
• Plain lid is unmarked

PART NO.	DESCRIPTION	CTN QTY
S36006	8" water lid and ring	1
S36007	8" sewer lid	1
S36008	8" sewer lid and ring	1
S36090	8" plain lid	1
S36091	8" plain lid and ring	1
S36011	10" water lid and ring	1
S36009	10" sewer lid only	1
S36010	10" sewer lid and ring	1
S36095	10" plain lid	1
S36096	10" plain lid and ring	1

Water Access Box



• Lockable lid

PART NO.	DESCRIPTION	CTN QTY
J60026	6" x 6" x 2"	6

Perforated Vent Box



PART NO.	DESCRIPTION	CTN QTY
J60027	6" x 6" x 2"	6

Philadelphia Style Vent Box



• Strainer secured by overlapping lug and screw
• Integral cast baffles

PART NO.	DESCRIPTION	CTN QTY
J60004	4" Inside caulk	1
J60094	Strainer Replacement	1

Fresh Air Inlet/ Floor Drain



PART NO.	DESCRIPTION	CTN QTY
J60007	3" Spigot	15
J60008	4" Spigot	15

Vent Cap



• Cast iron cap for 3" or 4" pipe

PART NO.	DESCRIPTION	CTN QTY
J60005	3" - 4" vent cap	10

Lockable Vent Cap



- Cast iron grate fits inside spigot end of pipe
- Secured with adjustable screw and clamp

PART NO.	DESCRIPTION	CTN QTY
J60010	4" cast iron vent cap	10

Brass Deck Plug



- Inside caulk
- Polished brass ring
- Cast brass body
- Skid-resistant scoriated lid

PART NO.	SIZE	CTN QTY
D28003	3"	12
D28004	4"	12

Blind Plugs



No Hub		
PART NO.	SIZE	CTN QTY
D59202	2"	10
D59203	3"	10
D59204	4"	8

Service Weight		
PART NO.	SIZE	CTN QTY
D59302	2"	10
D59303	3"	8
D59304	4"	4

Reading Style Cleanout



- 4" Inside caulk

PART NO.	DESCRIPTION	CTN QTY
J60012	Reading Cleanout	1

Plumbest Cast Iron Backwater Valves



- Reduces Backflow in drainage system
- All neoprene gaskets
- 300 series stainless bolts and washers
- Repairable in service
- Revolutionary design- that works!

Service Weight				
PART NO.	SIZE	LENGTH	HUB	CTN QTY
B01013	3"	10-3/4"	5-1/8"	1
B01014	4"	11-3/4"	6-1/2"	1
B01016	6"	12-3/4"	7-1/4"	1

No Hub				
PART NO.	SIZE	LENGTH	HUB	CTN QTY
B01002	2"	10-3/4"	—	1
B01003	3"	11-3/4"	—	1
B01004	4"	12-3/4"	—	1
B01006	6"	14-1/2"	—	1

Replacement Flappers		
PART NO.	DESCRIPTION	CTN QTY
B01017	2" bolt-in flapper and ring	1
B01018	3" bolt-in flapper and ring	1
B01019	4" bolt-in flapper and ring	1
B01020	6" bolt-in flapper and ring	1

Reading Style Vent



- 4" Inside caulk

PART NO.	DESCRIPTION	CTN QTY
J60011	Reading Vent	1

Test Tee



- Available with or without plug
- Plug is Southern Code

Service Weight Tee				
PART NO.	DESCRIPTION	LENGTH	PLUG	CTN QTY
T55002	2"x 2" less plug	10-3/8"	2"	1
T55012	2"x 2" with plug	10-3/8"	2"	1
T55003	3"x 3" less plug	12-1/2"	3"	1
T55013	3"x 3" with plug	12-1/2"	3"	1
T55004	4"x 4" less plug	13-7/8"	4"	1
T55014	4"x 4" with plug	13-7/8"	4"	1

No Hub Tee				
PART NO.	DESCRIPTION	LENGTH	PLUG	CTN QTY
T56002	2"x 2" less plug	6-3/8"	2"	1
T56012	2"x 2" with plug	6-3/8"	2"	1
T56003	3"x 3" less plug	7-3/4"	3"	1
T56013	3"x 3" with plug	7-3/4"	3"	1
T56004	4"x 4" less plug	8-7/8"	4"	1
T56014	4"x 4" with plug	8-7/8"	4"	1

Test Tee with Heavy Plug



Service Weight Tee With Heavy Plug				
PART NO.	DESCRIPTION	LENGTH	PLUG	CTN QTY
T55022	2"x 2"	10-3/8"	2"	1
T55033	3"x 3"	12-1/2"	3"	1
T55044	4"x 4"	13-7/8"	4"	1

No Hub Tee With Heavy Plug				
PART NO.	DESCRIPTION	LENGTH	PLUG	CTN QTY
T56022	2"x 2"	6-3/8"	2"	1
T56033	3"x 3"	7-3/4"	3"	1
T56044	4"x 4"	8-7/8"	4"	1

Cast Iron Single Vent Running Trap



PART NO.	DESCRIPTION	CTN QTY
T64540	5"x 4" single vent running trap	1

Tapped Saddle Tees



- U-bolt included

PART NO.	SIZE	CTN QTY
T21001	3"x 1 1/2"	1
T21002	3"x 2"	1
T21003	4"x 1 1/2"	1
T21004	4"x 2"	1
S26008	6" x 7" (1/4" thick) closed cell foam gasket	1

Repair Plate



- U-bolt included

PART NO.	DESCRIPTION	CTN QTY
T21062	2" Plate with u-bolt	1
T21063	3" Plate with u-bolt	1
T21064	4" Plate with u-bolt	1

"T" Burner Bar



- 12-1/4" long by 1-3/8" high, tapped 1/2" IPS in ends and bottom
- Supplied with two 1/2" plugs and close nipple orifice

PART NO.	DESCRIPTION	LENGTH	HEIGHT	CTN QTY
L75080	Natural Gas	12-1/4"	1-3/8"	10
L75180	LPG	12-1/4"	1-3/8"	10

Two Leg Burner



- Dimensions 14" long x 1-3/4" high x 2-1/4" wide
- Tapped 1/2" IPS on both ends and one leg
- Comes with two 1/2" IPS plugs and close nipple orifice
- Ledge over burner holes prevents clogging

PART NO.	DESCRIPTION	LENGTH	HEIGHT	CTN QTY
L75081	Natural Gas	14"	1-3/4"	10
L75181	LPG	14"	1-3/4"	10

Round Burner



- 1-3/4" high x 4 1/2" wide, tapped 1/2" IPS in bottom and sides
- Supplied with close nipple orifice and 1/2" plug

PART NO.	DESCRIPTION	WIDTH	HEIGHT	CTN QTY
L75086	Natural Gas	4-1/2"	1-3/4"	10
L75186	LPG	4-1/2"	1-3/4"	10

Rectangular Burner



- Dimensions 8-3/4" long x 1-1/2" high x 1-3/4" wide with 1/2" IPS inlet
- Supplied with close nipple orifice and removable lid
- Low Profile

PART NO.	DESCRIPTION	LENGTH	HEIGHT	CTN QTY
L75085	Natural Gas	8-3/4"	1-1/2"	10
L75185	LPG	8-3/4"	1-1/2"	10

Log Lighter Burner Bars



- Air mixing chamber
- Straight: 17" pipe plus 3" mixing chamber
- T-Pattern: Two 7" pipes plus 3" mixing chamber

PART NO.	DESCRIPTION	CTN QTY
L75091	Straight for natural gas	10
L75092	Straight for LPG	10
L75095	Tee for natural gas	10
L75096	Tee for LPG	10

Log Lighter Valves

- CSA design certified
- Brass Escutcheon
- 1/4" Key included
- Individually tested (pressure test in open and closed position after installation)
- BTU rating: angle 188,000, straight 120,000
- To extend escutcheon use 1/2" pipe coupling and 1/2" pipe nipple

Standard Valve (7 turns open/close)



PART NO.	DESCRIPTION	CTN QTY
L75001	Chrome plated angle	25
L75002	Polished brass angle	25
L75006	Chrome plated straight	25
L75007	Polished brass straight	25

Ball Valve (1/4" turn)



PART NO.	DESCRIPTION	CTN QTY
L75040	Chrome plated angle	25
L75041	Polished brass angle	25
L75042	Chrome plated straight	25
L75043	Polished brass straight	25

Escutcheons Only

PART NO.	DESCRIPTION	CTN QTY
L75908	Chrome plated	1
L75909	Polished brass	1

Combo Log Lighter Valves



- Straight or angle pattern
- 5/16" key and brass plug for extra outlet included

PART NO.	DESCRIPTION	CTN QTY
L75009	Chrome plated	10
L75010	Polished brass	10

Log Lighter Valves with T-Burner



- Solid brass escutcheon, 1/4" key and close nipple orifice included
- Individually tested (pressure test open and closed after installation)
- Angle: 188,000 BTU/Straight: 120,000 BTU

PART NO.	DESCRIPTION	CTN QTY
L75406	Chrome plated angle natural gas	1
L75407	Polished brass angle natural gas	1
L75408	Chrome plated straight natural gas	1
L75409	Polished brass straight natural gas	1
L75400	Chrome plated angle LPG	1
L75401	Polished brass angle LPG	1
L75402	Chrome plated straight LPG	1
L75403	Polished brass straight LPG	1

Log Lighter Keys and Accessories

- 1/4" and 5/16" drives on keys

All Brass Keys



PART NO.	DESCRIPTION	CTN QTY
L75019	1/4"x 3"	5
L75020	5/16"x 3"	5
L75021	1/4"x 6"	5
L75023	1/4"x 12"	5
L75022	5/16"x 6"	5
L75024	5/16"x 12"	5

Die Cast Zinc Keys



PART NO.	DESCRIPTION	CTN QTY
L75017	1/4"x 3"	5
L75018	5/16"x 3"	5

Close Nipple Orifices



PART NO.	DESCRIPTION	CTN QTY
L75015	7/64" Orifice for natural gas	1
L75016	5/64" Orifice for LP gas	1

A
 Area Drain 24
 Assembled Cleanouts..... 20–22

B
 Backwater Device 25
 Backwater Valves..... 30
 Bar Grate 29
 Bell Traps 26
 Blind Plugs 30
 Brass Deck Plug..... 30

C
 Cast Iron Single Vent Running Trap 31
 Cesspool Drain..... 27
 Cleanout Bodies..... 15
 Cleanout Cover Plates 19
 Cleanout/Extension Covers 19
 Cleanout Plugs..... 17–18
 Cleanouts
 Adjustable Push-On 21
 No Hub Cleanout 20–22
 Plain End Cleanout 20
 Push-On Cleanout 20
 Cleanout Spuds..... 15–16
 Closet Flange 2–3
 Repair Flange..... 3
 Closet Flange Repair Ring..... 3

D
 Des Moines Pattern Floor Drain 25
 Drain Bodies..... 4, 5
 Drain Trap 25

E
 Extension Cover Set 18

F
 Floor Drain..... 25, 27
 Floor Drains 9–14
 Floor/ Shower 11, 13
 Floor Sinks 28
 Fresh Air Inlet/ Floor Drain..... 29
 Funnels 6

G
 Gapper Flange..... 3
 Gas Burners
 Log Lighter Burner Bars 32
 Rectangular Burner 32
 Round Burner..... 32
 “T” Burner Bar..... 32
 Two Leg Burner 32
 Gasket Connection Drain..... 24

H
 Hydrant Cesspool..... 27

K
 Kentucky Drain..... 24

L
 Log Lighter Burner Bars 32
 Log Lighter Keys..... 33
 Log Lighter Valves 32–33

M
 Mop Hanger 28
 Mop Service Basin 28

N
 Non-Adjustable Drain..... 7

P
 Perforated Vent Box 29
 Philadelphia Style Vent Box..... 29
 Push-On Cleanout 20

R
 Rainleader Cesspool..... 27
 Reading Style Cleanout 30
 Reading Style Vent..... 30
 Repair Plate 31
 Replacement Strainers 7, 10
 For Roman Tub Drains 7
 Regular Strainers 7
 Roman Tub Drains 7
 Roof Drains 23

S
 Service Sink 28
 Service Sink Faucets..... 28
 Sewer Box..... 29
 Shower and Floor Drains 8
 Shower Drain 24
 Shower Drains 7, 8, 10
 Shower Stall Drains..... 24
 Slab Drain 9, 10, 11, 14
 Spuds..... 5–6
 St. Louis Drain 24

T
 Tapped Saddle Tees..... 31
 “T” Burner Bar 32–33
 Test Tee 31
 Trap Covers 19
 Trap Standard..... 28

U
 Urinal Drain 25

V
 Vent Cap..... 29
 Lockable Vent Cap 30

W
 Water Access Box..... 29

PART NO	PAGE
A40001	F22
A40002	F22
A40003	F22
B01002	F30
B01003	F30
B01004	F30
B01006	F30
B01013	F30
B01014	F30
B01016	F30
B01017	F30
B01018	F30
B01019	F30
B01020	F30
B06001	F25
B60099	F26
B60994	F26
B70499	F25
C01001	F3
C01002	F3
C33001	F22
C33002	F22
C33003	F22
C33004	F22
C33005	F22
C33006	F22
C33021	F21
C33022	F21
C33023	F21
C33031	F21
C33032	F21
C33033	F21
C33044	F21
C33045	F21
C33046	F21
C33121	F21
C33122	F21
C33123	F21
C33144	F21
C33145	F21
C33146	F21
C33221	F22
C33222	F22
C33223	F22
C33231	F22
C33232	F22
C33233	F22
C33244	F22
C33245	F22

PART NO	PAGE
C33246	F22
C33321	F22
C33322	F22
C33323	F22
C33331	F22
C33332	F22
C33333	F22
C33344	F22
C33345	F22
C33346	F22
C33444	F22
C33445	F22
C33446	F22
C33544	F22
C33545	F22
C33546	F22
C36003	F20
C36004	F20
C36006	F20
C36013	F20
C36014	F20
C36016	F20
C36024	F20
C36034	F20
C36104	F20
C36106	F20
C36114	F20
C36116	F20
C36124	F20
C36134	F20
C37002	F15
C37003	F15
C37004	F15
C37005	F15
C37006	F15
C37014	F15
C37102	F15
C37103	F15
C37104	F15
C37302	F15
C37303	F15
C37304	F15
C37314	F15
C37800	F16
C37801	F16
C37803	F16
C37805	F16
C37806	F16
C37807	F16

PART NO	PAGE
C37808	F16
C37810	F16
C37811	F16
C38002	F20
C38003	F20
C38004	F20
C38005	F20
C38006	F20
C38014	F20
C38102	F20
C38103	F20
C38104	F20
C38114	F20
C38202	F20
C38203	F20
C38204	F20
C38205	F20
C38206	F20
C38214	F20
C38402	F20
C38403	F20
C38404	F20
C38502	F20
C38503	F20
C38504	F20
C39002	F20
C39003	F20
C39004	F20
C39005	F20
C39006	F20
C39014	F20
C39102	F20
C39103	F20
C39104	F20
C39114	F20
C39202	F20
C39203	F20
C39204	F20
C39205	F20
C39206	F20
C39214	F20
C39402	F20
C39403	F20
C39404	F20
C39502	F20
C39503	F20
C39504	F20
C40002	F21
C40003	F21

PART NO	PAGE
C40004	F21
C40006	F21
C40102	F20
C40103	F20
C40104	F20
C40320	F2
C40420*	F2
C40425	F2
C40430*	F2
C40440*	F2
C40500	F2
C40503	F2
C40640	F3
C41410	F2
C41411	F2
C41420	F2
C41421	F2
C41430	F2
C41440	F2
C41460	F2
C43440	F3
C43441	F3
C44420	F3
C44440	F3
C45433	F2
C46331*	F2
C46351*	F2
C46431	F2
C46451	F2
C47320	F2
C47340	F2
C47420	F2
C47430	F2
C47440	F2
C47460	F2
C49421	F3
C49440	F3
C49441	F3
C49442	F3
C72002	F24
C72003	F24
C72004	F24
C72093	F24
C73003	F24
C73004	F24
C73093	F24
C73094	F24
C73192	F24
C73193	F24

PART NO	PAGE
C85000	F3
C85500	F3
C87100	F3
C90002	F19
C90004	F19
C90006	F19
C90013	F19
C90014	F19
C90015	F19
C90016	F19
C90017	F19
C90018	F19
C90019	F19
C90300	F19
C90400	F19
C90500	F19
C90600	F19
C90700	F19
C90800	F19
C90999	F19
C91013	F19
C91014	F19
C91015	F19
C91016	F19
C91017	F19
C91018	F19
C91019	F19
C91300	F19
C91400	F19
C91500	F19
C91600	F19
C91700	F19
C91800	F19
C91999	F19
C92150	F18
C92151*	F18
C92200	F18
C92202*	F18
C92250	F18
C92252*	F18
C92300	F18
C92301	F18
C92303*	F18
C92350	F18
C92351	F18
C92353*	F18
C92400	F18
C92404*	F18
C92500	F18

PART NO	PAGE
C92600	F18
C92601	F18
C92800	F18
C93150	F18
C93200	F18
C93250	F18
C93300	F18
C93301	F18
C93350	F18
C93351	F18
C93400	F18
C93500	F18
C94004	F19
C94005	F19
C94007	F19
C94009	F19
C95004	F19
C95005	F19
C95007	F19
C95009	F19
C96004	F19
C96005	F19
C96007	F19
C96009	F19
C97004	F19
C97005	F19
C97007	F19
C97009	F19
C98001	F19
C98002	F19
C98014	F19
C98016	F19
C98018	F19
D28003	F30
D28004	F30
D40000	F7
D40001	F7
D40002	F7
D40102	F24
D40103	F24
D40104	F24
D40150	F24
D40200	F24
D40202	F24
D40203	F24
D40204	F24
D45002	F25
D50095	F27
D56500	F6

PART NO	PAGE
D56501	F6
D56502	F6
D56503	F6
D56504	F6
D56505	F6
D59101	F29
D59102	F29
D59103	F29
D59104	F29
D59106	F29
D59112	F29
D59113	F29
D59114	F29
D59124	F29
D59126	F29
D59128	F29
D59130	F29
D59132	F29
D59156	F27
D59158	F27
D59160	F27
D59162	F27
D59202	F30
D59203	F30
D59204	F30
D59302	F30
D59303	F30
D59304	F30
D59901	F16
D59902	F16
D59904	F16
D59905	F16
D59906	F16
D59907	F16
D59908	F16
D59909	F16
D59910	F16
D59911	F16
D59912	F16
D59913	F16
D59914	F16
D59915	F16
D59916	F16
D59917	F16
D59918	F16
D59919	F16
D59940	F16
D59941	F16
D59942	F16

PART NO	PAGE
D59943	F16
D59944	F16
D59945	F16
D59946	F16
D60100	F8
D60101	F8
D60101	F24
D60102	F8
D60103	F8
D60201	F8
D60202	F8
D60203	F8
D60204	F8
D60205	F8
D60206	F8
D60207	F8
D60208	F8
D60209	F8
D60210	F8
D60211	F8
D60212	F8
D60400	F8
D60402	F8
D60403	F8
D60410	F8
D60412	F8
D60413	F8
D60498	F8
D60499	F8
D60900	F4
D60901	F4
D60902	F4
D60954	F6
D60955	F6
D60956	F6
D60958	F6
D60959	F6
D60960	F6
D60961	F6
D60962	F6
D60963	F6
D60966	F6
D60967	F6
D60970	F6
D60975	F6
D60979	F5
D60980	F6
D60981	F6
D60982	F6

PART NO	PAGE
D60986	F6
D60986	F6
D60987	F6
D60987	F6
D60989	F6
D60990	F6
D60991	F6
D60992	F6
D60993	F6
D60994	F6
D60995	F6
D60996	F6
D60997	F6
D60998	F6
D60999	F6
D61101	F8
D61102	F8
D61103	F8
D61201	F8
D61202	F8
D61203	F8
D61301	F8
D61302	F8
D61303	F8
D61800	F4
D61801	F4
D61802	F4
D61850	F8
D62130	F5
D62131	F5
D62132	F5
D62135	F5
D62136	F5
D62137	F5
D62140	F5
D62141	F5
D62142	F5
D62230	F15
D62231	F15
D62232	F15
D62235	F15
D62236	F15
D62237	F15
D62240	F15
D62241	F15
D62242	F15
D62300	F5
D62300	F15
D62330	F21
D62333	F21

PART NO	PAGE
D62334	F21
D62335	F21
D62349	F5
D62349	F15
D62350	F5
D62350	F15
D62400	F5
D62400	F15
D62433	F21
D62434	F21
D62443	F21
D62444	F21
D62601	F21
D62602	F21
D62950	F24
D62951	F24
D62952	F24
D62960	F24
D62961	F24
D62962	F24
D63300	F5
D63300	F15
D63330	F21
D63333	F21
D63334	F21
D63335	F21
D63349	F5
D63349	F15
D63350	F5
D63350	F15
D63400	F5
D63400	F15
D63433	F21
D63434	F21
D64000	F7
D6400BN	F7
D6400NP	F7
D6400RB	F7
D6400WB	F7
D64001	F7
D64002*	F7
D64010	F7
D64011 (with test cap)	F7
D64012*	F7
D64022*	F7
D64150	F7
D64202	F7
D64302*	F7
D64401	F7
D64402	F7

PART NO	PAGE
D64402G	F7
D64502	F7
D64800	F7
D64801	F7
D64802	F7
D64803	F7
D64804	F7
D64805	F7
D64806	F7
D64807	F7
D64808	F7
D64809	F7
D64810	F7
D64811	F7
D65002	F4
D65003	F4
D65102	F4
D65103	F4
D65104	F4
D65202	F4
D65203	F4
D65500	F9
D65501	F9
D65502	F9
D65503	F9
D65504	F9
D65505	F9
D65509	F9
D65510	F9
D65511	F9
D65512	F9
D65520	F11
D65521	F11
D65522	F11
D65523	F11
D65524	F11
D65525	F11
D65560	F9
D65561	F9
D65562	F9
D65563	F9
D65564	F9
D65565	F9
D65569	F9
D65570	F9
D65571	F9
D65572	F9
D65580	F12
D65581	F12
D65582	F12

PART NO	PAGE
D65583	F12
D65584	F12
D65585	F12
D65600	F14
D65601	F14
D65602	F14
D65603	F14
D65604	F14
D65605	F14
D65620	F10
D65621	F10
D65622	F10
D65623	F10
D65624	F10
D65625	F10
D65640	F12
D65641	F12
D65642	F12
D65643	F12
D65644	F12
D65645	F12
D65655	F9
D65656	F9
D65657	F12
D65658	F12
D65659	F14
D65660	F14
D65661	F9
D65662	F9
D65663	F11
D65664	F11
D65665	F10
D65667	F12
D65668	F12
D66002	F4
D66003	F4
D66004	F4
D66102	F4
D66103	F4
D66104	F4
D66200	F5
D66202	F4
D66203	F4
D66204	F4
D66300	F5
D66400	F5
D66500	F9
D66501	F9
D66502	F9
D66503	F9

PART NO	PAGE
D66504	F9
D66505	F9
D66509	F9
D66510	F9
D66511	F9
D66512	F9
D66520	F11
D66521	F11
D66522	F11
D66523	F11
D66524	F11
D66525	F11
D66540	F13
D66541	F13
D66542	F13
D66543	F13
D66544	F13
D66545	F13
D66560	F9
D66561	F9
D66562	F9
D66563	F9
D66564	F9
D66565	F9
D66569	F9
D66570	F9
D66571	F9
D66572	F9
D66580	F12
D66581	F12
D66582	F12
D66583	F12
D66584	F12
D66585	F12
D66600	F14
D66601	F14
D66602	F14
D66603	F14
D66604	F14
D66605	F14
D66620	F10
D66621	F10
D66622	F10
D66623	F10
D66624	F10
D66625	F10
D66640	F12
D66641	F12
D66642	F12

PART NO	PAGE
D66643	F12
D66644	F12
D66645	F12
D66660	F13
D66661	F13
D66662	F13
D66663	F13
D66664	F13
D66665	F13
D66675	F9
D66676	F9
D66677	F12
D66678	F12
D66679	F14
D66680	F14
D66681	F9
D66682	F9
D66683	F11
D66684	F11
D66685	F13
D66686	F13
D66687	F10
D66688	F10
D66689	F12
D66690	F12
D66691	F13
D66692	F13
D66700	F10
D66701	F10
D66702	F10
D66703	F10
D66704	F10
D66705	F10
D66706	F10
D66707	F10
D66715	F12
D66716	F12
D66717	F12
D66718	F12
D66719	F12
D66720	F12
D66721	F12
D66722	F12
D66732	F14
D66733	F14
D66734	F14
D66735	F14
D66736	F14
D66737	F14

PART NO	PAGE
D66738	F14
D66739	F14
D67001	F9
D67002	F9
D67003	F9
D67004	F9
D67005	F9
D67006	F9
D67007	F9
D67008	F9
D67016	F10
D67017	F10
D67018	F10
D67019	F10
D67020	F10
D67021	F10
D67022	F10
D67023	F10
D67027	F10
D67028	F10
D67029	F10
D67030	F10
D67031	F11
D67032	F11
D67033	F11
D67034	F11
D67035	F11
D67036	F11
D67037	F11
D67038	F11
D67039	F11
D67040	F11
D67041	F11
D67042	F11
D67043	F11
D67044	F11
D67045	F11
D67046	F11
D67047	F11
D67048	F14
D67049	F14
D67050	F14
D67051	F14
D67052	F14
D67053	F14
D67054	F14
D67055	F14
D67200	F5
D67201	F5

PART NO	PAGE
D67300	F5
D67400	F5
D68507	F10
D68508	F10
D68510	F10
D68511	F10
D68512	F10
D68513	F10
D68610	F10
D68611	F10
D68612	F10
D68613	F10
D68710	F10
D68711	F10
D68712	F10
D68713	F10
D70001	F25
D70011	F25
D70020	F25
D70021	F25
D70022	F25
D70098	F25
D70500	F25
D71003	F25
D71004	F25
D71103	F25
D76002	F24
D76003	F24
D76004	F24
D76005	F22
D76012	F24
D76013	F24
D76014	F24
D76092	F24
D76093	F24
D76094	F24
D76202	F26
D76203	F26
D76204	F26
D76205L	F26
D76205L	F26
D76207L	F26
D76207L	F26
D76209L	F26
D76209L	F26
D76252	F26
D76252	F26
D76256	F26
D76256	F26

PART NO	PAGE
D76259	F26
D76259	F26
D76302	F26
D76303	F26
D76304	F26
D76402	F26
D76403	F26
D76404	F26
D76412	F26
D76413	F26
D76414	F26
D76504	F27
D76519	F27
D76601	F25
D76702	F27
D76703	F27
D76704	F27
D76705	F27
D76706	F27
D76707	F27
D77002	F24
D77003	F24
D77004	F24
D79703	F27
D79704	F27
D79705	F27
D79706	F27
D79803	F27
D79804	F27
D79805	F27
D79806	F27
D80090	F4
D80091	F4
D80096	F4
D80097	F4
D80098	F4
D80099	F4
D80100	F11
D80101	F11
D80102	F11
D80103	F11
D80106	F13
D80107	F13
D80108	F13
D80109	F13
D80112	F11
D80113	F11
D80118	F13
D80119	F13

PART NO	PAGE
D80200	F11
D80201	F11
D80202	F11
D80203	F11
D80206	F13
D80207	F13
D80208	F13
D80209	F13
D80210	F13
D80211	F13
D80212	F11
D80213	F11
D80214	F11
D80215	F11
D80216	F11
D80217	F11
D80218	F13
D80219	F13
D80220	F13
D80221	F13
D80222	F13
D80223	F13
F10005	F25
F65400	F6
F65600	F6
J60004	F29
J60005	F29
J60007	F29
J60008	F29
J60010	F30
J60011	F30
J60012	F30
J60026	F29
J60027	F29
J60030	F27
J60060	F25
J60061	F25
J60062	F25
J60094	F29
L75001	F32
L75002	F32
L75006	F32
L75007	F32
L75009	F33
L75010	F33
L75015	F33
L75016	F33
L75017	F33
L75018	F33

PART NO	PAGE
L75019	F33
L75020	F33
L75021	F33
L75022	F33
L75023	F33
L75024	F33
L75040	F32
L75041	F32
L75042	F32
L75043	F32
L75080	F32
L75081	F32
L75085	F32
L75086	F32
L75091	F32
L75092	F32
L75095	F32
L75096	F32
L75180	F32
L75181	F32
L75185	F32
L75186	F32
L75400	F33
L75401	F33
L75402	F33
L75403	F33
L75406	F33
L75407	F33
L75408	F33
L75409	F33
L75908	F32
L75909	F32
M05001	F28
M05003	F28
P50100	F17
P50125	F17
P50150	F17
P50200	F17
P50250	F17
P50300	F17
P50350	F17
P50400	F17
P50500	F17
P50600	F17
P50800	F17
P50999	F17
P51150	F17
P51200	F17
P51250	F17

PART NO	PAGE
P51300	F17
P51350	F17
P51400	F17
P51500	F17
P51600	F17
P51800	F17
P52150	F17
P52200	F17
P52250	F17
P52300	F17
P52350	F17
P52400	F17
P52500	F17
P53150	F17
P53200	F17
P53250	F17
P53300	F17
P53350	F17
P53400	F17
P53500	F17
P54150	F18
P54200	F18
P54250	F18
P54300	F18
P54350	F18
P54400	F18
P54500	F18
P54600	F18
P54800	F18
P55150	F17
P55250	F17
P55300	F17
P55350	F17
P55500	F17
P56200	F17
P56250	F17
P56300	F17
P56350	F17
P56400	F17
P56450	F17
P56500	F17
P56550	F17
P56600	F17
P58150	F18
P58200	F18
P58250	F18
P58300	F18
P58350	F18
P58400	F18

PART NO	PAGE
P59300	F18
P59333	F18
P59350	F18
P59355	F18
P59400	F18
P59444	F18
R18020	F23
R19003	F23
R19004	F23
R19005	F23
R19006	F23
R19099	F23
R19100	F23
R19102	F23
R19103	F23
R19104	F23
R19202	F23
R19203	F23
R19204	F23
R19206	F23
R19302	F23
R19303	F23
R19304	F23
R19305	F23
R19306	F23
R19307	F23
R19402	F23
R19403	F23
R19404	F23
S26008	F31
S36006	F29
S36007	F29
S36008	F29
S36009	F29
S36010	F29
S36011	F29
S36090	F29
S36091	F29
S36095	F29
S36096	F29
S55004	F28
S55010	F28
S55050	F28
S55075	F28
S55100	F27
S55101	F27
S55104	F28
S55112	F28
S55113	F28

PART NO	PAGE
S55114	F28
S55115	F28
S55122	F28
S55123	F28
S55124	F28
S55192	F28
S55193	F28
S55194	F28
S55240	F28
S55349	F28
S55350	F28
S55351	F28
S55352	F28
S55353	F28
S55354	F28
S57034	F27
S57035	F27
S60002	F28
S60003	F28
S60004	F28
T00002	F28
T00003	F28
T00005	F28
T00006	F28
T00007	F28
T00009	F28
T21001	F31
T21002	F31
T21003	F31
T21004	F31
T21062	F31
T21063	F31
T21064	F31
T55002	F31
T55003	F31
T55004	F31
T55012	F31
T55013	F31
T55014	F31
T55022	F31
T55033	F31
T55044	F31
T56002	F31
T56003	F31
T56004	F31
T56012	F31
T56013	F31
T56014	F31
T56022	F31

PART NO	PAGE
T56033	F31
T56044	F31
T64540	F31



SECTION G - TOOLS

VOLUME V



Quality
Products *for*
the Plumbing
Professional

Tub And Shower Valve Wrench Set



- Complete set with handle includes: 21/32" x 27/32, 29/32" x 31/32", 1 1/32" x 1 3/32", 1 11/32" x 1 7/16"
- Plated steel

PART NO.	DESCRIPTION	CTN QTY
J40002	Valve wrench set	25
J40000	21/32" x 27/32" wrench only	20
J40001	1 1/32" x 1 3/32" wrench only	20
J40006	29/32" x 31/32" wrench only	20
J40008	1 11/32" x 1 7/16" wrench only	50

Garbage Disposal Wrench



- 1/2" steel
- 10" long

PART NO.	DESCRIPTION	CTN QTY
J40025	Disposal wrench	10

4-Way Key



Carded

- Plated steel
- For valve, faucet and sillcock sizes 1/4", 9/32", 5/16" and 11/32"

PART NO.	DESCRIPTION	CTN QTY
J40005	4-way key (carded)	50

No Hub Torque Wrench



Carded

- Automatic release at 60 in.lb.
- Built-in reversing lever
- Ratchets one way
- Chrome vanadium socket

PART NO.	DESCRIPTION	CTN QTY
T60060	No hub torque wrench (carded)	10

Mega Torque Wrench



- Slide down locking reversing feature
- Heavy duty construction with chrome vanadium sockets
- 60 lb. = 5/16" socket/80 lb = 3/8" socket

PART NO.	DESCRIPTION	CTN QTY
T60065	60 lb. - Mega Torque Wrench	1
T60080	80 lb. - Mega Torque Wrench with 3/8" Socket	1
T60081	80 lb. - Mega Torque Wrench with 5/16" Socket	1
T60066	5/16" Socket kit	1

Element Wrench



- Zinc plated steel
- For removing heater elements

PART NO.	DESCRIPTION	CTN QTY
J36100	Regular unit wrench	10
J36101	Heavy duty wrench	10

Sillcock Key



- Die cast
- 5/16" and 1/4"

PART NO.	DESCRIPTION	CTN QTY
J40003	1/4" Sillcock key	10
J40004	5/16" Sillcock key	10

14 Piece Folding Hex Key Wrench Set



- Chrome plated steel case
- Fourteen fractional U.S. sizes

PART NO.	DESCRIPTION	CTN QTY
J40015	Hex key wrench set (carded)	1

Basin Wrenches



B11010



B11012



B11011



B11013 Replacement Jaw

- Spring-hinged jaw
- Telescoping body allows for easier use in hard-to-reach areas
- Swivel head operates from either right or left side
- Use on hard-to-reach basin nuts, ballcocks and flush valves

PART NO.	DESCRIPTION	JAW	CTN QTY
B11010	10"-17" telescoping	1 1/4"	10
B11011	11 3/8" long non-telescoping	1 1/4"	10
B11012	9 1/2" - 16 1/2" telescoping	2"	10
B11013	Spring hinged replacement jaw for B11011	-	1

Radiator Spud Wrench



- Plated malleable iron
- For use as spud key and wrench

PART NO.	DESCRIPTION	CTN QTY
J40030	Radiator spud wrench	5

4-Way P.O. Plug Wrench



- For installing or removing basket strainers, tub drains and p.o. plugs

PART NO.	DESCRIPTION	CTN QTY
J40026	4-way p.o. plug wrench	5

4-Way Plug Wrench



PART NO.	DESCRIPTION	CTN QTY
J40040	4-way countersunk plug wrench	5

4-Way Countersunk Plug Wrench



- For installing or removing countersunk plugs

PART NO.	DESCRIPTION	CTN QTY
J40041	4-way countersunk plug wrench	1

6-Way Countersunk Plug Wrench



- 4 head sizes for square plugs
- 2 head sizes for slotted plugs
- Extra-strong iron construction

PART NO.	DESCRIPTION	CTN QTY
J40042	6-way wrench	5

Faucet Seat Repair Kit



Carded

- Reversible cone
- 4 sizes of cutters
- Hardened steel cutters smooth worn seats
- Saves repair costs; stops faucet drips
- Kit includes faucet washers and bibb screw

PART NO.	DESCRIPTION	CTN QTY
J40007	Faucet seat repair kit	1

Faucet Seat Wrench



- Tapered for use on all sizes and types of seats

PART NO.	DESCRIPTION	CTN QTY
S62001	Straight tapered wrench	10
S62002	Angle tapered wrench	10
S62003	Straight stepped wrench	10
S62004	Angle stepped wrench	10

Seat Wrench For Recessed Seats



- Works in hard-to-reach recessed seats

PART NO.	DESCRIPTION	CTN QTY
S62005	Seat wrench for recessed seats	50

Dual Kwik Tite Wrench



- Install stops easily
- Tightens 3/8" supply nuts

PART NO.	DESCRIPTION	CTN QTY
J40490	Dual Kwik Tie Wrench	1

Lavatory Nut Removal Tool



- Lightweight, high strength plastic
- For 7/8" metal or plastic hex nuts
- Extra long to reach mounting nuts on faucets, sprayers, and ballcocks

PART NO.	DESCRIPTION	CTN QTY
J40035	Lavatory Nut Removal Tool	10/50

Universal Drain Wrench



Carded

- 6" long
- Die cast aluminum
- Installs and removes tub drains and closet spuds
- Prevents damage to decorative finishes
- Use crescent wrench or screwdriver to turn tool

PART NO.	DESCRIPTION	CTN QTY
J45010	Universal drain wrench (carded)	1

Angle Compression Stop Wrench



- Fits 3/8" compression or 1/2" male IPS outlet threads on angle stops
- Protects finishes

PART NO.	DESCRIPTION	CTN QTY
J40491	Angle compression stop wrench	1

Extract-a-Drain Tub Drain Removal Tool



- Removes old or rusty drains - even drains with missing crossbars!
- Fits both 1 1/4" and 1 1/2" tub drains
- Jaws expand to firmly grip the inside of the drain
- Prevents damage to your tub's finish
- A wrench is the only other tool that you'll need to complete this job

PART NO.	DESCRIPTION	CTN QTY
J40018	Extract-a-drain tool	1

Compression Sleeve Puller



- Removes leaking compression sleeves without damaging walls
- Unique armless design - screws directly into compression nut for fast removal
- For 5/8" compression nuts
- Made in the U.S.A. (J40021)

PART NO.	DESCRIPTION	CTN QTY
J40021	Compression sleeve puller (carded)	6
J44661	Compression sleeve puller - 1/2" OD	6

Compression Sleeve Puller Adapter



- Converts any standard faucet handle puller to remove compression sleeves

PART NO.	DESCRIPTION	CTN QTY
J40013	Adapter	10

E-ZEE Pull Deluxe Faucet Handle Puller



- 4" bracket width
- Pulls all size handles
- Forged steel with case - hardened pin

PART NO.	DESCRIPTION	CTN QTY
J40012	E-ZEE pull deluxe faucet handle puller	5

Faucet Handle Pullers



- Plated steel
- Removes faucet and valve handles

PART NO.	DESCRIPTION	CTN QTY
J40010	Standard unit (carded)	5
J40011	Heavy duty impact unit	5

Quick Drain Wrench



- Installs no caulk shower drains quickly
- Provides tongue to seal drain

PART NO.	DESCRIPTION	CTN QTY
J40235	Quick Drain Wrench	6

Sink Drain Wrench



- Fits kitchen, bath & laundry tub basket strainers, "P" traps, wing nuts and tub drains
- Made in the U.S.A.

MADE IN THE USA

PART NO.	DESCRIPTION	CTN QTY
J40023	Sink drain wrench	6

Moen Stem And Cartridge Wrench



- Removes Moen stems and cartridges
- Works on plastic and brass faucet and shower valves

PART NO.	DESCRIPTION	CTN QTY
J45015	Stem and cartridge wrench (carded)	12

Adjustable Strainer And Spud Wrench



- Fits closet spuds, basket strainers, lock nuts and slip nuts
- Adjustment 7/8" to 3 1/8"
- Plated

PART NO.	DESCRIPTION	CTN QTY
J40022	Strainer & spud wrench	5

Spud Wrench



- For strainer, lock and slip nuts
- 1" - 3" capacity
- Heat treated forging

PART NO.	DESCRIPTION	CTN QTY
J40305	Spud wrench	1

Spud Wrench With Hinged Arm



PART NO.	DESCRIPTION	CTN QTY
J40306	Spud wrench with hinged arm	10

Spanner/Strainer Wrench



- Plated malleable iron
- Used for basket strainer jam nuts

PART NO.	DESCRIPTION	CTN QTY
J40024	Spanner/strainer wrench	5

Strainer Wrench



- For use on basket strainers and tub drains with cross bars
- Long handle for leverage
- Plated steel

PART NO.	DESCRIPTION	CTN QTY
J40028	Strainer wrench	5

Plumb Easy Sink Strainer Wrench



- Fits most basket strainers
- Installs and removes basket strainers with ease

PART NO.	DESCRIPTION	CTN QTY
J40128	Plumb Easy sink strainer wrench	4/16

Do All Plumbers Wrench



- Longer, more comfortable handle allows greater leverage for tightening or loosening locknuts
- Fits most standard size basket strainers including: Opella, Duo, Twist Lock and PB Duo. Use on any strainer which uses a standard 3 3/8" locknut
- Fits most shower stall drains
- Fits the following drain styles:
 - 2" Plastic No Caulk for plastic pipe
 - 2" Brass No Caulk for plastic pipe
 - 2" Receptor Base for plastic pipe
 - 2" Drop In style for plastic pipe

PART NO.	DESCRIPTION	CTN QTY
J40019	Do All plumbers wrench (Carded)	1

Heavy Duty Pipe Wrench



- Manufactured to U.S. Specification GGG-W651 Type II Class A
- Upper and lower jaws forged and tempered
- Nodular cast iron handle



PART NO.	ROTHENBERGER	LENGTH	CAPACITY	CTN QTY
J40065	7.0150	8"	1"	6
J40066	7.0151	10"	1 1/2"	6
J40067	7.0152	12"	2"	6
J40068	7.0153	14"	2"	1
J40069	7.0154	18"	2 1/2"	1
J40070	7.0155	24"	3"	1
J40105	7.0156	36"	5"	1

Aluminum Pipe Wrench



- Manufactured to U.S. Specification GGG-W651 Type I Class B
- Forged and tempered handle, bottom jaw and nut
- Alloy handle



PART NO.	ROTHENBERGER	LENGTH	CAPACITY	CTN QTY
J40071	7.0159	10"	1 1/2"	6
J40072	7.0160	14"	2"	6
J40073	7.0161	18"	2 1/2"	6
J40074	7.0162	24"	3"	1
J40106	7.0163	36"	5"	1

Adjustable Wrench



- Drop forged
- Chrome plated
- Manufactured to Federal Specification GGG-W-631-B Type I Class I



PART NO.	LENGTH	CAPACITY	CTN QTY
J40075	6"	13/16"	6
J40076	8"	15/16"	6
J40077	10"	1 3/16"	6
J40078	12"	1 3/8"	6
J40079	15"	1 3/8"	6

Curb Box Wrench



- For pentagon curb boxes
- Thin wall socket fits most boxes

PART NO.	DESCRIPTION	CTN QTY
M25900	Curb box wrench	1

Box Wrench



- For B and MC tanks

PART NO.	DESCRIPTION	CTN QTY
J40230	Box wrench	1

Bibb Seat Tool Set



- Set includes:
 - 3/8" x 7/16" ratcheting box wrench
 - small hex/large hex tapered bibb seat tool
 - small square/large square tapered bibb seat tool
 - small square/large square straight bibb seat tool

PART NO.	DESCRIPTION	CTN QTY
J40308	Bibb seat tool set	1

Strap Wrench



- For chrome fittings and nipples

PART NO.	DESCRIPTION	CTN QTY
J40307	7" strap wrench	1
J40311	11" strap wrench	1

Twist-Off Strap Tool



Carded

- Grips when wet
- Will not scratch
- High density polyethylene handle
- Heavy duty rubber strap

PART NO.	DESCRIPTION	CTN QTY
J40325	Twist-off Strap Tool(carded)	1

Hydrostatic Pressure Pump



- Maximum pressure 700 PSI
- 1/2" NPT hose connection
- Three gallon tank capacity



PART NO.	ROTHENBERGER	DESCRIPTION	CTN QTY
J40223	6.1004	Complete pressure pump unit	1
J40224	6.1313	0 - 700 PSI gauge	1
J40225	6.1300	Piston	1

RP 30 Hydrostatic Test Pump



- For quick pressure testing and/or air tight testing
- Ideal for use in small spaces
- Steel reinforced test hose
- Test up to 440 lbs
- No false reading from any bulging of the hose!



PART NO.	DESCRIPTION	CTN QTY
J40123	Hydrostatic Test Pump	1

High Pressure Hose with Fitting



- For hydrostatic pressure pump

PART NO.	DESCRIPTION	CTN QTY
J40198	High pressure hose with fitting	1

Air Pump



- Large diameter
- Heavy metal construction
- Pressure gauge included

PART NO.	DESCRIPTION	CTN QTY
P10001	Heavy duty pump	1

Economy Air Pump



PART NO.	DESCRIPTION	CTN QTY
P10002	1 1/2" x 18" air pump	10

Water Pump



- Excellent for draining water meter boxes
- High impact PVC; non-sparking; lightweight
- No priming necessary- removes 35 ounce/stroke
- Remove foot valve to clean

PART NO.	DESCRIPTION	CTN QTY
P13600	36" pump with 72" discharge hose	1

Copper Fitting Brush



- Carbon steel
- CARTON QUANTITIES ONLY

Wire Handle			
PART NO.	ID	OD	CTN QTY
B28025	1/4"	3/8"	12
B28375	3/8"	1/2"	12
B28050	1/2"	5/8"	12
B28051	1/2"	5/8"	100-bulk
B28075	3/4"	7/8"	12
B28076	3/4"	7/8"	100-bulk
B28100	1"	1 1/8"	12
B28125	1 1/4"	1 3/8"	6
B28150	1 1/2"	1 5/8"	6
B28200	2"	2 1/8"	6
Wooden Handle			
PART NO.	ID	OD	CTN QTY
B29025	1/4"	3/8"	12
B29375	3/8"	1/2"	12
B29050	1/2"	5/8"	12
B29051	1/2"	5/8"	100-bulk
B29075	3/4"	7/8"	12
B29076	3/4"	7/8"	100-bulk
B29100	1"	1 1/8"	12
B29125	1 1/4"	1 3/8"	6
B29150	1 1/2"	1 5/8"	6
B29200	2"	2 1/8"	6

4-N-1 Copper Tube Fitting Brush



- Includes four long lasting high carbon steel brushes for 1 1/2" and 3/4" copper tube and fittings

PART NO.	DESCRIPTION	CTN QTY
B10004	Copper tube and fitting brush	6

Female Copper Tube Brush



- For cleaning copper tubing
- CARTON QUANTITIES ONLY

PART NO.	DESCRIPTION	CTN QTY
B29625	CTS OD 5/8" copper tube brush	6
B29875	CTS OD 7/8" copper tube brush	6
B29999	CTS OD 1 1/8" copper tube brush	6

Socket Savers



- Removes Schedule 40 plastic pipe
- Cuts ABS or PVC DWV pipe below slab
- Fits 1/2" variable speed power drill
- Carded for display

PART NO.	DESCRIPTION	CTN QTY
J44050	1/2" Socket Saver	1
J44075	3/4" Socket Saver	1
J44100	1" Socket Saver	1
J44150	1 1/2" Socket Saver	1
J44200	2" Socket Saver	1
J44300	3" Socket Saver	1
J44400	4" Socket Saver	1

Inside Pipe Cutter



- Cuts 2" and larger plastic pipe
- Fits electric drill

PART NO.	DESCRIPTION	CTN QTY
P70023	3" shaft with 2 blades	10
P70029	3 replacement blades	10

PlumBest E-Z Shear Inside Pipe Cutter



- Cuts PVC and ABS pipe
- High speed steel blade with zinc-plated shaft

PART NO.	DESCRIPTION	CTN QTY
J40830	E-Z shear inside pipe cutter	1
J40831	Two (2) E-Z shear replacement blades	1

PVC Pipe Cutters



- High carbon steel blades
- Repair kits includes all screws and springs needed to repair cutter
- Aluminum alloy handles
- Ratchet action

PART NO.	DESCRIPTION	CTN QTY
P70001	1" pipe cutter (carded)	1
P70005	1" replacement blade	1
P70015	1" repair kit	1

Heavy Duty PVC Pipe Cutters



- High carbon steel blades
- Repair kits includes all screws and springs needed to repair cutter
- Aluminum alloy handles

PART NO.	DESCRIPTION	CTN QTY
P70010	1" heavy duty pipe cutter (boxed)	1
P70011	1" heavy duty replacement blade	1
P70012	1" repair kit	1
P70002	2" pipe cutter (boxed)	1
P70006	2" replacement blade	1
P70016	2" repair kit	1

PVC One-Handed Pipe Cutters



- Easy one-handed ratchet cutting action
- Spring loaded blade
- Heat treated hardened steel blade for straighter cuts - longer life
- Contractor quality - great for plumbers, pool contractors, electricians, etc.
- Cuts up to 2" pipe (2 1/2" OD)

PART NO.	DESCRIPTION	CTN QTY
P70035	2" PVC One-handed pipe cutter	1
P70036	2" replacement blade	1

Professional PVC Pipe Cutter



- Rustproof
- Capacity to 1 1/4" diameter PVC
- The blade is non-electro nickel plated which ensures a sharper blade
- Locking hook can be used to deburr pipe

PART NO.	DESCRIPTION	CTN QTY
P70018	1 1/4" PVC pipe cutter (carded)	6
P70019	Replacement blade for P70018	1
P70020	Repair kit	1

Vinyl Tubing Cutter



- Plastic body
- Cuts up to 1" vinyl tubing

PART NO.	DESCRIPTION	CTN QTY
P70030	Vinyl tube cutter	10
P70031	Vinyl tube cutter replacement blade	10

Telescopic Tubing Cutter



- Extra wheel in handle
- Grooved roller
- 1/4"- 1 1/4" cutter
- Imported
- Built-in deburring tool

PART NO.	DESCRIPTION	CTN QTY
P70050	Telescopic tubing cutter	1
P70055	Replacement cutter wheel	1
P70056	Two (2) Replacement cutter wheels	1

Telescoping Tubing Cutter



- Enclosed feed mechanism
- Grooved rollers for close-to-flare cuts
- Anodized body for corrosion resistance
- Allows cut with shorter arc
- Fold-away reamer
- Spare cutter wheel stored in body



PART NO.	ROTHENBERGER	DESCRIPTION	CTN QTY
J40240	7.0010	1/8" - 1 1/8" O.D. capacity	1
J40241	7.0011	1/4" - 1 5/8" O.D. capacity	1
J40242	7.0007	Replacement cutter wheel	1
J40243	51250	Cutter wheel pin	10
J40244	51240	Cutter wheel pin retaining ring	10

Enclosed Feed Tube Cutter



Retractable
Deburring
Blade

- Extra cutter in knob
- Heavy duty one piece slide
- Polished rollers for easy rotation
- Cuts: Copper, brass, aluminum tubing, thin-wall conduit

PART NO.	DESCRIPTION	CTN QTY
P70064	1/8" x 1 3/16"	1
P70056	Two (2) Replacement cutter wheels	1

Quick Release Tubing Cutter



P70069 Carded

- Spring-loaded for quick size adjustment
- Spring cutter wheel in handle
- Imported

PART NO.	DESCRIPTION	CTN QTY
P70065	1/4" - 2" O.D. Capacity tubing cutter	1
P70069	Two (2) Replacement cutter wheels (carded)	1

Quick Release Tubing Cutter



- Spring-loaded ratchet allows for quick size adjustment and release
- Spare cutter wheel in handle



PART NO.	ROTHENBERGER	DESCRIPTION	CTN QTY
J40217	7.0030	1/4" - 2 5/8" heavy duty cutter	1
J40218	7.0005	Repl. cutter wheel for metal	10
J40219	7.0028	Repl. cutter wheel for plastic	10
J40228	7.0006	Cutter wheel screw	10

Economy Tube Cutter



- Screw-feed
- Zinc plated

PART NO.	DESCRIPTION	CTN QTY
P70066	1/8" - 1 1/8"	1
P70067	Replacement blades (slide blister)	2

Mini Tubing Cutter



PART NO.	ROTHENBERGER	DESCRIPTION	CTN QTY
J40213	7.0001	5/8" capacity tubing cutter	1
J40214	7.0002	7/8" capacity tubing cutter	1
J40215	7.0003	Replacement cutter wheel	10
J40228	7.0006	Cutter wheel screw	10

Mini Tubing Cutter



- 1/8" - 1/2" cutter

PART NO.	DESCRIPTION	CTN QTY
P70051	Mini tubing cutter - 1/8"-7/8"	1
P70060	Mini tubing cutter- 1/8"- 1 1/8"	1
P70067	Replacement blades (slide blister)	2

Mini Tubing Cutter



- Good for all soft metal tubing

PART NO.	DESCRIPTION	CTN QTY
P70052	Mini tubing cutter- 1/8"- 7/8"	1
P70053	Mini tubing cutter- 1/8"- 1 1/8"	1
P70067	Replacement blades (slide blister)	2

Copper Tube Cutter



- Self-clamping and self-aligning
- Easy to use in close quarters
- Cuts copper and PVC quickly and easily

PART NO.	DESCRIPTION	CTN QTY
J40260	1/2" Copper tube cutter	1
J40261	3/4" Copper tube cutter	1
J40263	Replacement blades for J40260 & J40261	1

Ratcheting Handle Copper Tube Cutter



- Cuts multiple sizes of copper, aluminum tubing, and thin-wall conduit
- Long handle for more leverage

PART NO.	DESCRIPTION	CTN QTY
J40262	1/4"-3/4" Ratcheting handle copper tube cutter	1

Romax Compact Cordless Press Tool



- Lightweight- 5.4 lbs
- Battery powered
- One hand operation
- Interchangeable press jaws rotate 350 degrees
- Connects 1/2", 3/4", and 1" copper tubing in about 6 seconds
- Automatically releases when connection is complete



PART NO.	DESCRIPTION	CTN QTY
J40900	Complete kit (includes- 901 thru -936)	1
J40901	1/2" Compact Jaw	1
J40902	3/4" Compact Jaw	1
J40903	1" Compact Jaw	1
J40935	Compact Battery Charger	1
J40936	Compact Battery	1

Romax Pressliner Cordless Press Tool



- Battery powered
- Connects up to 4" copper or brass fittings with 7200 lbs. of pressing force in about 8 seconds
- Interchangeable press jaws rotate 270 degrees
- Automatically releases when connection is complete
- 4 switch system allows activation in a variety of hold positions
- Automatically releases when connection is complete



PART NO.	DESCRIPTION	CTN QTY
J40920	Kit includes: 1/2", 3/4", 1", 1 1/4", 1 1/2", 2" jaws, 2 batteries, charger and case	1
J40930	Kit includes: 1/2", 3/4", 1", 1 1/4", 1 1/2", 2" jaws, 2 batteries, charger and case	1
J40921	1/2" pressliner jaw	1
J40922	3/4" pressliner jaw	1
J40923	1" pressliner jaw	1
J40924	1 1/4" pressliner jaw	1
J40925	1 1/2" pressliner jaw	1
J40926	2" pressliner jaw	1
J40937	Pressliner Battery Charger	1
J40938	Pressliner Battery	1

E-Z Stroke Pipe Saw



S49005

S49007

S49008

- For smooth, fast, accurate cutting
- Tri-edge teeth are borazon wheel ground
- Pull-stroke cutting action
- Cuts plastic pipe and wood
- Replaceable blade

PART NO.	DESCRIPTION	CTN QTY
S49005	8" E-Z stroke pipe saw	10
S49006	8" Replacement blade	1
S49008	12" E-Z stroke pipe saw	10
S49007	12" Replacement blade	1

PlumBest Plastic Saw



- Die cast aluminum handle
- Quickly cuts PVC, ABS, wood, sheetrock, etc.
- Large comfortable grip
- Flame hardened blade
- 18" blade has 10 teeth/inch

PART NO.	DESCRIPTION	CTN QTY
S49001	18" PlumBest saw	6
S49002	18" Replacement blade	10
S49010	Handle only	10

Drywall Saw



- High quality carbon steel blade
- Great for sheetrock, wallboard, gypsum, plywood, wood and plastic pipe
- 6" 8 TPI aggressive tooth design ensures super sharp, fast & easy cut
- Comfortable grip with thumb stop for greater leverage
- Handy wrist strap

PART NO.	DESCRIPTION	CTN QTY
S49012	Drywall saw	5
S49013	Replacement blade	5

Jr. Plumber's Saw



- Die cast aluminum handle
- Case hardened steel blade
- Deburs as it cuts
- Cuts up to 4" PVC pipe
- 8 1/2" blade; 10 teeth/inch
- Unique nose teeth permit starting cuts on flat surfaces

PART NO.	DESCRIPTION	CTN QTY
S49004	Jr. Plumber's saw	1
S49000	8 1/2" Replacement blade	1

Hardwood 250 Speed Handsaw



- Great for hardwood and laminated wood
- Tri-edge and impulse hardened teeth for accurate rip, cross and slant cuts

PART NO.	DESCRIPTION	CTN QTY
S49200	Hardwood 250 Speed Handsaw	10/60
S49201	Replacement blade	50/100

Cable Saws

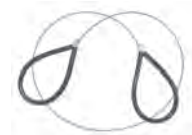

- For cutting PVC pipe
- For tight spots offering little clearance
- Fits easily into tool box and pocket
- Faster and easier than hacksaws in close quarters
- Individually bagged with header card

Bagged with Header

PART NO.	DESCRIPTION	CTN QTY
S49136	36" cable saws with display	36
S49148	48" cable saws with display	24
S49036	36" cable saw	1
S49048	48" cable saw	1

T-Handle Cable Saw



Bagged with Header

- For cutting PVC pipe
- Strong and comfortable t-handles
- Polybagged with header card
- Great for use in tight spots
- Long-lasting stainless steel cutting cable

PART NO.	DESCRIPTION	CTN QTY
S49236	36" cable saw	1

Close Quarters Hacksaw



S50060

S50062

- Nickel plated steel frame
- Cuts wood, plastic, brass, aluminum and steel

PART NO.	DESCRIPTION	CTN QTY
S50060	6" close quarters hacksaw	10
S50061	Replacement blades for S50060	5
S50062	6" adjustable hacksaw	10
S50063	Replacement blades for S50062	5

PlumBest Hacksaw



- Heavy square tubing and die cast construction
- Stores extra blades
- Blade tensioning adjustment
- Cuts flush with surface

PART NO.	DESCRIPTION	CTN QTY
S49003	Hacksaw with blade	1

Hacksaw Blades



- Available in carded 10-pack only
- Bi-metal or carbon steel blade

PART NO.	DESCRIPTION	CTN QTY
J40094	12" / 18 tooth bi-metal blade	10/pack
J40095	12" / 24 tooth bi-metal blade	10/pack
J40096	12" / 32 tooth bi-metal blade	10/pack
J40097	12" / 18 tooth carbon steel blade	10/pack
J40098	12" / 24 tooth carbon steel blade	10/pack
J40099	12" / 32 tooth carbon steel blade	10/pack

Utility Knife



- Heavy duty construction
- Supplied with extra blade
- Coated case

PART NO.	DESCRIPTION	CTN QTY
K50041	Utility knife	10
K50042	Five replacement blades per pack	10

Snap Knife



- Seven point snap-off blade
- Counter display box has 30 pcs.
- Replacement blades
- CARTON QUANTITIES ONLY
- 10 per tube, priced each

PART NO.	DESCRIPTION	CTN QTY
K50001	Snap knives with display box	30
K50002	7 point snap knife	1
K50003	7 point replacement blade	10

Deluxe Autolock Snap Knife



- Blade automatically locks into position
- Contoured shape for a more comfortable grip

PART NO.	DESCRIPTION	CTN QTY
K50005	Deluxe autolock snap knife	1

Aviation Snips



- Meets or exceeds Federal Spec GGG-S-291e, ANSI/AME B109-16-1985
- Molybdenum alloy blades
- Made in the USA
- Compound action
- Hot drop forged

MADE IN THE
USA

PART NO.	DESCRIPTION	CTN QTY
J40056	Right hand cut aviation snips	1
J40057	Left hand cut aviation snips	1

Offset Aviation Snip



- Offset for easier use
- Great for cutting at difficult angles

PART NO.	DESCRIPTION	CTN QTY
J40156	Right hand cut offset aviation snips	1
J40157	Left hand cut offset aviation snips	1
J40158	Straight cut aviation snips	1

Fiberglass Handle Shovels



- STINGER SERIES - Fiberglass handle is 40% stronger than Federal Strength Test for long handle wood tools.
- Large steel collar adds maximum strength to handle/socket connection.
- Forward - turned step for secure foot placement

PART NO.	DESCRIPTION	AMES #	BUNDLE QTY
S49411	Long handle round point	SFGLR	6
S49412	Long handle square point	SFGLS	6
S49416	D-Handle 16" drain spade	SFGD16	6
S49413	Long handle 16" drain spade	SFGDSL	6

Premium Grade Wood Handle Shovels



- Lacquered ash handle
- Premium blade

PART NO.	DESCRIPTION	AMES #	BUNDLE QTY
S49421	Long handle round point	BMTLR	6
S49422	Long handle square point	BMTLS	6
S49417	D-Handle round point	BMTDR	6
S49423	D-Handle 16" drain spade	15-738	6
S49425	LH trenching shovel 4" blade	15-566	6
S49427	LH trenching shovel 5" blade	15-567	6

Economy Shovels



PART NO.	DESCRIPTION	AMES #	BUNDLE QTY
S49431	Long handle round point	15-047	6
S49432	Long handle square point	15-049	6

Specialty Shovels



- KODIAK CUB - smaller design for easier use in tight spaces
- 16 gauge tempered steel blade
- Forward turned step
- 27" overall length

PART NO.	DESCRIPTION	AMES #	BUNDLE QTY
S49429	Compact utility shovel	15-663	6

Long Handle Round Point Fiberglass Shovel



- Long fiberglass handle
- Round point

PART NO.	DESCRIPTION	BUNDLE QTY
S49400	Long handle round point	1

Cold Chisels



- Designed for cutting cast iron or steel

PART NO.	DESCRIPTION	CTN QTY
J41002	1" wide x 8" regular length	6

Packing Or Yarning Tools



PART NO.	DESCRIPTION	CTN QTY
J41006	5/8" wide x 12" long	6

Short Nose Caulking Tools



- For finishing lead joint

PART NO.	DESCRIPTION	CTN QTY
J41008	5/8" wide x 7 1/2" long	6

Inside Caulking Tools



- For finishing lead joint

PART NO.	DESCRIPTION	CTN QTY
J41009	5/8" wide x 7" long	6

Outside Caulking Tools



- For finishing lead joint

PART NO.	DESCRIPTION	CTN QTY
J41010	5/8" wide x 7" long	6

Broad Curve Nose Caulking Tools



- Used for packing Oakum tight
- For first pass on lead

PART NO.	DESCRIPTION	CTN QTY
J41011	5/8" wide x 8" x 1 1/2"	6

17 Pound Digging/Tamping Bar



- For digging holes, cutting roots or tamping

PART NO.	DESCRIPTION	CTN QTY
S49500	1" x 69" post hole digger	1

Utility Pry Bar



PART NO.	DESCRIPTION	CTN QTY
S49489	14" utility pry bar	5

Manhole Cover Lifter

- 25" long



PART NO.	DESCRIPTION	CTN QTY
S49490	Manhole cover lifter	6

Gooseneck Wrecking Bar



- Painted and polished
- Claw on end removes nails

PART NO.	DESCRIPTION	CTN QTY
S49501	30" wrecking bar	10

Striking Tools



MADE IN THE USA



- Made in the USA
- Hickory handles
- Long life - high quality

PART NO.	DESCRIPTION	CTN QTY
J40144	3 lb. engineers hammer	2
J40142	6 lb. sledgehammer	6
J40143	8 lb. sledgehammer	6

Pick Mattock



- Hardwood handle
- 5 pound head

PART NO.	DESCRIPTION	CTN QTY
J40141	5 lb. pick mattock with handle	6
J40145	Replacement handle	12

Railroad Pick



- Hardwood handle
- 6 pound head

PART NO.	DESCRIPTION	CTN QTY
J40140	6 lb. railroad pick with handle	6
J40145	Replacement handle	12

Probing Rod



- Weather resistant fiberglass
- Eliminates danger of shock
- Tip is not replaceable

PART NO.	DESCRIPTION	CTN QTY
P27048	4'	5

Steel Probing Rod



- Stainless steel tips
- Cushion vinyl handle
- Welded steel construction

PART NO.	DESCRIPTION	CTN QTY
P27004	4'	10
P27005	5'	10
P27001	Stainless steel tip	5

Steel Probing Rod With Ball Point



Ballpoint Tip

- Steel shaft
- Vinyl handle for comfort
- Carbon steel ballpoint will not puncture soft pipe
- Tip is not replaceable

PART NO.	DESCRIPTION	CTN QTY
P27003	3' metal probing rod	1
P27040	4' metal probing rod	1

Water Meter Keys



- Rebar shaft and handle for greater strength
- Vinyl covered handle comfort

PART NO.	DIAMETER x LENGTH	BUNDLE QTY
M25127	1/2" x 27"	10
M25136	1/2" x 36"	10
M25148	1/2" x 48"	10
M25527	5/8" x 27"	5
M25536	5/8" x 36"	10
M25560	5/8" x 60"	10
M25736	3/4" x 36"	10
M25760	3/4" x 60"	10
M25772	3/4" x 72"	10
M25784	3/4" x 84"	10

Combo Water Meter Key



- Rebar shaft and handle for greater strength
- Vinyl covered handle comfort
- Combo lid key and meter key

PART NO.	SIZE	BUNDLE QTY
M25130	1/2" x 30"	1

Gate Valve Key



PART NO.	SIZE	CTN QTY
M25100	30"	5

Copper Sizing Tool



- For type "M" copper tubing
- Impact type to reround tube

PART NO.	DESCRIPTION	CTN QTY
J40750	1/2" Copper sizing tool	6
J40775	3/4" Copper sizing tool	6
J40800	1" Copper sizing tool	6

Copper Swedge Tool



J40375

J40369

- Use J40375 on 1/4", 5/16", 3/8", 1/2", and 5/8" copper tube
- Use J40369 on 5/8", 7/8", and 1 1/8" copper tube
- Heat-treated carbon steel
- Can also be used on soft copper, aluminum or any other thin-walled tubing

PART NO.	DESCRIPTION	CTN QTY
J40375	Copper swedge tool	1
J40369	Copper swedge tool (up to 1 1/8")	1

Polybutylene Crimping Tools



- Single crimp and combo tools
- Made in the USA
- Accurate and easy to use
- Unit can be calibrated in the field

MADE IN THE
USA

PART NO.	DESCRIPTION	CTN QTY
J42002	1/2" regular crimping tool	1
J42003	3/4" regular crimping tool	1
J42004	1/2" - 3/4" combo crimping tool	1

Note: These tools cannot be returned for repair.

Pex Crimp Set



J40950



J40952



J40965



J40966

- For use on crimping PEX pipe with copper crimp rings and stainless steel bands

PART NO.	DESCRIPTION	CTN QTY
J40950	PEX crimp set with 3/8", 1/2", 3/4"	1
J40951	3/8" PEX crimp tool	1
J40952	1/2" PEX crimp tool	1
J40953	3/4" PEX crimp tool	1
J40954	1" PEX crimp tool	1
J40955	PEX crimp sizing tool	1
J40960	PEX crimp ring cutter	1
J40965	One hand PEX SS clamp tool	1
J40966	PEX SS clamp tool	1

Flaring Tool



- Makes smooth flare
- For O.D. sizes 3/16", 1/4", 5/16", 3/8", 1/2" and 5/8"

PART NO.	DESCRIPTION	CTN QTY
J40080	Bar flaring tool	1

Swing Release Flaring Tool



- 3/16"- 5/8" O.D.
- 45° single flare

PART NO.	ROTHENBERGER	DESCRIPTION	CTN QTY
J40220	2.6003	45° flaring tool	1
J40250	-	Roller for J40220	1
J40251	-	Roller Pin for J40220	1

Deburring Tool



- Easily removes burrs inside and outside of copper and plastic
- Handle stores spare blades

PART NO.	DESCRIPTION	CTN QTY
J40221	Deburring tool with blade	1
J40222	Replacement blade only	1

Nipple Extractor Sets



PART NO.	DESCRIPTION	CTN QTY
J40054	Nipple extractor set - 3/8", 1/2", 3/4"	1
J40055	Nipple extractor set - 3/8", 1/2", 3/4", 1"	1

Internal Pipe Nipple Extractors



- Heat treated and cad plated
- Removes or inserts nipples

PART NO.	DESCRIPTION	CTN QTY
J40050	3/8" nipple extractor	1
J40051	1/2" nipple extractor	1
J40052	3/4" nipple extractor	1
J40053	1" nipple extractor	1

Nipple And Screw Extractors



- Left hand spiral
- Removes nipples, bolts, and screws without thread damage

PART NO.	PIPE SIZE	DRILL SIZE	BOLT SIZE	CTN QTY
J41100	-	5/64"	3/32" - 5/32"	3
J41101	-	7/64"	5/32" - 7/32"	3
J41102	-	5/32"	7/32" - 9/32"	3
J41103	1/8"	1/4"	9/32" - 3/8"	3
J41104	1/4"	19/64"	3/8" - 5/8"	3
J41105	3/8"	13/32"	5/8" - 7/8"	1
J41106	1/2"	17/32"	7/8" - 1 1/8"	1
J41107	3/4"	13/16"	1 1/8" - 1 3/8"	1
J41108	1"	1 1/16"	1 3/8" - 2"	1

Carbide Tipped Masonry Drill Bit



PART NO.	REGULAR LENGTHS	SHANK SIZE	CTN QTY
S41349	5/32" x 4"	3/16"	6
S41351	3/16" x 4"	3/16"	6
S41350	1/4" x 4"	1/4"	6
S41352	5/16" x 4"	1/4"	6
S41353	3/8" x 6"	1/4"	6
S41354	7/16" x 6"	3/8"	6
S41355	1/2" x 6"	3/8"	2
S41356	9/16" x 6"	1/2"	2
S41357	5/8" x 6"	1/2"	2
S41361	5/8" x 12"	1/2"	2
S41358	3/4" x 6"	1/2"	2
S41359	7/8" x 6"	1/2"	2
S41362	7/8" x 12"	1/2"	2
S41360	1" x 6"	1/2"	2
S41363	1" x 12"	1/2"	2

Power Ship Augers

Long Pattern



- 17" overall length
- 12" twist

PART NO.	DESCRIPTION	CTN QTY
B22050	1/2" x 17"	1
B22625	5/8" x 17"	1
B22075	3/4" x 17"	1
B22087	7/8" x 17"	1
B22100	1" x 17"	1
B22112	1 1/8" x 17"	1
B22125	1 1/4" x 17"	1
B22150	1 1/2" x 17"	1

Dual Auger Wood Bits

Screw Point



- Up to 1" for use in 3/8" or 1/2" power drill; 1" and up for use in 1/2"

PART NO.	DESCRIPTION	CTN QTY
B21625	5/8" x 6" long	6
B21075	3/4" x 6" long	6
B21087	7/8" x 6" long	6
B21100	1" x 6" long	6
B21112	1 1/8" x 6" long	3
B21125	1 1/4" x 6" long	3
B21150	1 1/2" x 6" long	3

Flat "Paddle" Wood Bits



PART NO.	SIZE	CTN QTY
B24375	3/8"	1
B24050	1/2"	1
B24056	9/16"	1
B24063	5/8"	1
B24075	3/4"	1
B24081	13/16"	1
B24088	7/8"	1
B24100	1"	1
B24113	1 1/8"	1
B24125	1 1/4"	1
B24150	1 1/2"	1

Straight Shank Drill Bits



- High speed steel
- Jobber's length

PART NO.	DESCRIPTION	CTN QTY
B20062	1/16" drill	10
B20078	5/64" drill	10
B20094	3/32" drill	10
B20109	7/64" drill	10
B20125	1/8" drill	10
B20141	9/64" drill	10
B20156	5/32" drill	10
B20172	11/64" drill	10
B20188	3/16" drill	10
B20203	13/64" drill	10
B20219	7/32" drill	10
B20234	15/64" drill	10
B20250	1/4" drill	10
B20266	17/64" drill	5
B20281	9/32" drill	5
B20297	19/64" drill	5
B20313	5/16" drill	5
B20328	21/64" drill (1/8" pipe tap)	5
B20344	13/32" drill	5
B20359	23/64" drill	5
B20375	3/8" drill	5
B20391	25/64" drill	5
B20406	13/32" drill	5
B20422	27/64" drill	5
B20438	7/16" drill (1/4" pipe tap)	5
B20453	29/64" drill	5
B20469	15/32" drill	5
B20484	31/64" drill	5
B20500	1/2" drill	5

Pipe Taps



- NPT
- High carbon steel

PART NO.	DESCRIPTION	CTN QTY
T41001	1/8" NPT pipe tap	1
T41002	1/4" NPT pipe tap	1
T41003	3/8" NPT pipe tap	1
T41004	1/2" NPT pipe tap	1
T41005	3/4" NPT pipe tap	1
T41006	1" NPT pipe tap	1
T41009	1 1/4" NPT pipe tap	1
T41007	1 1/2" NPT pipe tap	1
T41008	2" NPT pipe tap	1

PlumbRule Tape Measure



- 1" locking blade with push button lock
- Offset fractions for easy reading
- Auto recoil; belt clip and wrist strap
- Red stud markings and joint markings

PART NO.	DESCRIPTION	CTN QTY
J40101	1" x 25' tape	6

Chrome Precision Tape



- 1" locking blade
- Tough tip

Starrett

PART NO.	DESCRIPTION	CTN QTY
J40085	1" x 25' chrome tape	6

Neon Precision Tape



- Sure grip case

PlumBest

PART NO.	DESCRIPTION	CTN QTY
J40086	1" x 25' neon orange tape	6
J40087	1" x 25' neon yellow tape	6

Long Tape



- Hook blade
- Pop-open handle

Starrett

PART NO.	DESCRIPTION	CTN QTY
J40088	3/8" x 50' tape	1
J40089	3/8" x 100' tape	1

Wood Folding Ruler With Extension



- 6" with 6" brass extension
- Maple blade with 16" stud markings

Starrett®

PART NO.	DESCRIPTION	CTN QTY
J40093	Wood rule with extension	6

Locking Measuring Tape



Call Us for Private Labeling



- Unbreakable chrome plated case
- Power return
- Double riveted tang
- Cushion stop
- Positive lock
- Yellow tape

PlumBest®

PART NO.	DESCRIPTION	CTN QTY
J40046	1" x 25' tape	1
J40045	3/4" x 16' tape	1

Flint Striker



- Round file style
- Renewable flint
- Flint priced per pack of 5 renewals

PART NO.	DESCRIPTION	CTN QTY
J40048	Striker	10
J40049	Pack of 5 flint renewals	1

Three Flint Friction Lighter



- Flint priced per pack of 4 renewals
- CARTON QUANTITIES ONLY

PART NO.	DESCRIPTION	CTN QTY
J40047	Three flint friction lighter	1
J40044	Flint renewal unit (4/card)	1

PlumBest MAPP & Propane Cylinders



- Temperatures for burning: Propane 2300°, MAPP 3300°
- CARTON QUANTITIES ONLY
- LTL TRANSPORTATION ONLY
- NO UPS/FED EX

PART NO.	DESCRIPTION	CTN QTY
J40601	14.1 oz. Propane	12
J40600	16 oz. MAPP	12

Uniweld Torches



J40529



J40629



PART NO.	DESCRIPTION	CTN QTY
J40529	Hand torch with swivel tip and self-igniter	6
J40329	UT6 replacement tip for J40529	1
J40629	Hand torch with swivel tip	6
J40429	UT5 replacement tip for J40629	1

Pencil Flame Torch



- Includes valve, stem, and burner
- For MAPP or propane



PART NO.	DESCRIPTION	CTN QTY
J40229	Pencil flame torch	1

Solder Shield Protective Blanket



- For use when combustible material is present during soldering
- 9" x 12" protection area
- Protects up to 2300°F for five minutes
- Smoke and odor free non-asbestos material
- Lends a clean, professional appearance to your work
- Durable woven ceramic holds up well in multiple uses

PART NO.	DESCRIPTION	CTN QTY
J40812	9" x 12" Solder shield	1

Flux Paste



- Super detergent action cleans as it solders
- Water soluble for faster flushing from pipe lines
- Non-acid, non-toxic, lead free
- Contains no zinc chloride

LA·CO™

PART NO.	DESCRIPTION	CTN QTY
S95102	4 oz. Flux Paste	48
S95103	1 lb. Flux Paste	24

Flux-Rite 90® Flux



- Meets ASTM B-813
- Water soluble for faster flushing from pipe lines
- Super detergent action cleans as it solders
- Non-acid, non-toxic and lead free
- Contains no zinc chloride
- Use with all lead free and common soft solders
- For use on most metal types

LA·CO™

PART NO.	DESCRIPTION	CTN QTY
S95104	4 oz. Flux-Rite 90® Flux	1
S95105	1 lb. Flux-Rite 90® Flux	1

Phos-Copper Brazing Rod



- 92.9% copper/ 7.1% phos
- Tensile strength 91,000 PSI
- Self-fluxing
- Liquid 1460°F, solid 1310°F
- Working temp 1350°-1500°F
- 1 pound plastic tubes

PART NO.	DESCRIPTION	CTN QTY
J41021	1 lb. tube brazing rod	1

2% Silver Solder



- 91% copper/ 7% phos/ 2% silver
- Liquid 1450°F, solid 1190°F
- Meets AWS A5.8QB-650 B Cup-6
- 1 pound plastic tubes

PART NO.	DESCRIPTION	CTN QTY
J41022	1 lb. tube 2% silver solder	1

5% Silver Solder



- 89% copper/ 6% phos/ 5% silver
- Meets AWS A5.8-81-BCup3 Fed QQB650B
- Liquid 1475°F, solid 1190°F
- Working temperature 1300°-1550°F
- 1 pound plastic tubes

PART NO.	DESCRIPTION	CTN QTY
J41023	1 lb. 5% silver solder	1

15% Silver Solder



- 80% copper/ 5% phos/ 15% silver
- Meets AWS A5.8-81-BC7P3 Fed QQB650B
- Liquid 1495°F, solid 1190°F
- Working temperature 1300°-1500°F
- 1 pound plastic tubes

PART NO.	DESCRIPTION	CTN QTY
J41024	1 lb. tube 15% silver solder	1

Freeze Fix Pipe Jackets



- Fast, easy way to freeze pipe up to 4"
- Saves time and money on pipe repairs
- Repairs can be made without draining the water out of the line

Quick Way to Freeze Pipes for Easy Repair!

PART NO.	DESCRIPTION	L x W	CTN QTY
J40801	3/8" - 3/4" jacket	8" x 4 1/2"	1
J40802	3/4" - 1 1/2" jacket	10 1/2" x 7"	1
J40803	1 1/2" - 3" jacket	14" x 8 1/2"	1
J40804	3" - 4" jacket	16" x 11"	1
J40805	8' hose and connectors for CO2 kit	-	1
J40806	Tee connector for CO2 freeze kit	-	1
J40807	Freeze fix carry bag	-	1
J40808	CO2 empty cylinder (20 lb. size)	-	1

Files

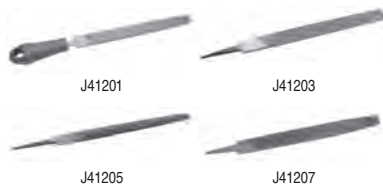

- Durable plastic handles
- Top quality alloy steel

PART NO.	DESCRIPTION	CTN QTY
J41201	8" mill bastard file with handle	1
J41202	10" mill bastard file with handle	1
J41203	8" flat bastard file	1
J41204	10" flat bastard file	1
J41205	8" half round file	1
J41206	10" half round file	1

Sure Sweat Dissolvable Pipe Plugs

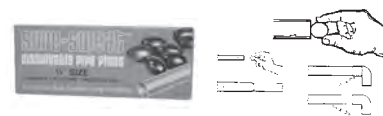

- Stop water from inside the pipe
- Dissolve safely and completely with water

PART NO.	DESCRIPTION	CTN QTY
H56050	1/2" kit (7 plugs per box)	1 box of 7
H56075	3/4" kit (5 plugs per box)	1 box of 5

Slip Jaw Pliers



- Plated finish
- Plastic grips

PART NO.	DESCRIPTION	CTN QTY
P60001	2 1/8" capacity / 10" long	5

Water Pump Pliers



- Drop forged vanadium steel; black epoxy powder coated
- Cushion grip
- Self-locking on pipe



PART NO.	ROTHENBERGER	LENGTH	CAPACITY	CTN QTY
J40210	7.0521	7"	1"	6
J40211	7.0522	10"	1 1/4"	6
J40212	7.0523	12"	1 1/2"	6

Griplock Tongue & Groove Water Pump Pliers



- Comfort grips



PART NO.	CHANNEL LOCK NO.	LENGTH	NO. ADJ.	CAPACITY	CTN QTY
J40410	GL10	10"	5	1 1/4"	5
J40411	GL12	12"	6	2 1/4"	5

"No Pinch" Pipe Wrench Pliers



- 10" comfort cushion grips
- Unique handle design prevents pinched fingers
- 1 3/4" jaw capacity
- Drop forged; plated finish

PART NO.	DESCRIPTION	CTN QTY
P60002	10" Pipe wrench pliers	5

10" Smooth Jaw Pliers



- 2 1/8" jaw opening
- Smooth jaws for non-arring surfaces (chrome, polished brass)
- Cushioned vinyl grips

PART NO.	DESCRIPTION	CTN QTY
P60003	10" Smooth jaw pliers	5

7" Offset Diagonal Cutting Pliers



Specially hardened cutting edges

- Chrome vanadium steel
- Offset shaft design for precise and maximum reach
- Cushion grip handle for extra leverage and comfort
- Equipped with convenient side cutter

PART NO.	DESCRIPTION	CTN QTY
J40420	7" Offset diagonal cutting pliers	12

8" Offset Long Nose Pliers

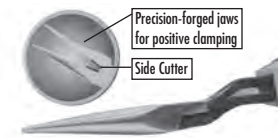

Precision-forged jaws for positive clamping
Side Cutter

- Chrome vanadium steel
- Offset maximum reach
- Cushion grip handle for extra leverage and comfort
- Equipped with convenient side cutter

PART NO.	DESCRIPTION	CTN QTY
J40421	8" Offset long nose pliers	12

8" Offset Slip Joint Pliers



Wire Cutter

- Chrome vanadium steel
- Offset jaws design for precise and maximum reach
- Cushion grip handle for extra leverage and comfort
- Equipped with wire cutting shears

PART NO.	DESCRIPTION	CTN QTY
J40422	8" Offset slip joint pliers	12

Tongue & Groove Pliers



- Right angle teeth
- Undercut tongue and groove-won't slip
- Comfort grips

CHAN NEL LOCK

PART NO.	CHANNEL LOCK NO.	LENGTH	NO. ADJ.	CAPACITY	CTN QTY
J40401	426	6 1/2"	5	7/8"	5
J40402	420	9 1/2"	5	1 1/2"	5
J40403	430	10"	7	2"	5
J40404	440	12"	7	2 1/4"	5
J40405	460	16"	8	4 1/4"	2

Curved Jaw Tongue & Groove Pliers



- Curved jaw for use on round stock and tubing
- Right angle teeth

CHAN NEL LOCK

PART NO.	CHANNEL LOCK NO.	LENGTH	NO. ADJ.	CAPACITY	CTN QTY
J40407	422	9 1/2"	5	1 1/2"	5
J40408	442	12"	7	2 1/4"	5

Smooth Jaw Tongue & Groove Pliers



- Smooth jaws for non-marring surfaces (PVC, chromes, etc.)
- Undercut tongue and groove-won't slip
- Comfort grips

CHAN NEL LOCK

PART NO.	CHANNEL LOCK NO.	LENGTH	NO. ADJ.	CAPACITY	CTN QTY
J40406	415	10"	7	2"	5

Long Nose Pliers



J40412

J40414

- Side cutter
- Polished high carbon drop forged steel
- Comfort grips

CHAN NEL LOCK

PART NO.	CHANNEL LOCK NO.	DESCRIPTION	CTN QTY
J40412	326	6" long nose plier	5
J40414	317	7 1/2" long nose plier	5

4 in 1 Screwdriver



S41001 - 12 pk Display

- Alloy tool steel bits
- Ground and polished
- Heat treated for maximum strength
- High impact handle
- Floating ball bearing for tight fit

PART NO.	DESCRIPTION	CTN QTY
S41001	Phillips and slotted	12
S41002	Slotted bit for 4 in 1 or 6 in 1	1
S41003	Phillips bit for 4 in 1	1

6 in 1 Screwdriver



S41006 - 12 pk Display

- Shaft ends are 1/4" and 15/16" hex size for use as nut drivers
- Each bit has two sizes

PART NO.	DESCRIPTION	CTN QTY
S41006	6 in 1 screwdriver	12
S41002	Slotted bit for 4 in 1 or 6 in 1	1
S41007	Phillips bit for 6 in 1	1

Spanner Screwdriver



- Notched for removing screws
- Heavy industrial handle with spanner holes
- Hardened steel tip

PART NO.	DESCRIPTION	CTN QTY
S41010	# 12 spanner remover	1

Screwdriver For # 8 And # 10 Screws



- One-Way for removing
- Heavy industrial handle #8 and #10 screws
- Hardened steel tip

PART NO.	DESCRIPTION	CTN QTY
S41012	#8 and #10 remover	1

Scratch Awl



PART NO.	DESCRIPTION	CTN QTY
S06020	Scratch Awl	10

Magnetic Power Nut Setters



- 1/4" hex shaft

PART NO.	DESCRIPTION	CTN QTY
S41300	1 3/4" long 1/4" head size	10
S41301	1 3/4" long 5/16" head size	10
S41302	2 9/16" long 1/4" head size	10
S41303	2 9/16" long 5/16" head size	10

Nut Driver



PART NO.	DESCRIPTION	CTN QTY
S06014	3/16" Nut driver	10
S06015	1/4" Nut driver	10
S06016	5/16" Nut driver	10
S06017	3/8" Nut driver	10
S06018	7/16" Nut driver	10
S06019	1/2" Nut driver	10

Bit Holders



- For insert type bits
- Magnetic

PART NO.	DESCRIPTION	CTN QTY
S41307	1/4" drive x 3" long	10

Phillips Bits



Insert Type		
PART NO.	DESCRIPTION	CTN QTY
S41306	#2 point 1/4" hex 1" long	10
Long Insert Type		
PART NO.	DESCRIPTION	CTN QTY
S41308	# 2 point 1/4" hex 11 5/16" long	10

100% Silicone Tub And Tile Sealant



J40197
J40199



J40200
J40201

- Ideal for tubs, sinks, toilets, showers and resetting loose tiles
- Warranted to last as long as the fixture
- Contains potent mildewcide
- CARTON QUANTITIES ONLY
- Application temperature range -10°F to 100°F
- Service temperature range -60°F to 400°F



PART NO.	DESCRIPTION	CTN QTY
J40199	2.8 oz. tube CLEAR caulk	12
J40197	2.8 oz. tube WHITE caulk	12
J40200	10.2 oz. tube CLEAR caulk	12
J40201	10.2 oz. tube WHITE caulk	12

PlumBest 100% Silicone Caulk



- Flexible, easy to use
- 50 year life
- CARTON QUANTITIES ONLY
- Will not stain or bleed
- Seal, bond or insulate



PART NO.	DESCRIPTION	CTN QTY
J40208	10.1 oz. tube CLEAR caulk	12
J40288	10.1 oz. tube WHITE caulk	12
J40289	10.1 oz. tube GRAY caulk	12

25-Year Siliconized Acrylic Caulk



- Cleans up with water
- Paintable
- Will not stain or bleed
- CARTON QUANTITIES ONLY
- Application temperature range 40°F to 90°F
- Service temperature range 0°F to 200°F



PART NO.	DESCRIPTION	CTN QTY
J40202	10.1 oz. tube WHITE caulk	12

Acrylic Tub And Tile Caulk



- Long-lasting watertight seal around tubs, showers, and sinks
- Cleans up with water
- Odorless, mildew resistant
- Paintable
- CARTON QUANTITIES ONLY
- Application temperature range 40°F to 90°F
- Service temperature range 0°F to 200°F



PART NO.	DESCRIPTION	CTN QTY
J40203	5.5 oz. ALMOND caulk	12
J40206	10.1 oz. WHITE caulk	12
J40204	5.5 oz. WHITE caulk	12

Latex Caulk



- General purpose
- Dries quickly
- Will not stain or bleed
- Paintable
- CARTON QUANTITIES ONLY



PART NO.	DESCRIPTION	CTN QTY
J40207	10.1 oz. WHITE caulk	12

Hi-Temp 100% Red Silicone Caulk



- 100% silicone
- USDA approved, UL listed, meets NSF 51
- Temperature from 65°F to 650°F
- CARTON QUANTITIES ONLY



PART NO.	DESCRIPTION	CTN QTY
J40285	Hi-temp 100% silicone caulk	12

Caulking Gun



- 9" barrel
- Drop-in half barrel type
- Painted steel

PART NO.	DESCRIPTION	CTN QTY
C35090	Caulking gun	10

Professional Caulking Gun



- Parallel hex rod frame
- Seal puncture tool
- Thumb release
- E-Z thrust mechanism
- Spout cutter
- Ladder hook

PART NO.	DESCRIPTION	CTN QTY
C35091	Parallel hex rod caulking gun	12

Firestop 814+ Intumescent Firestopping Sealant



J40284



J40286

- Colored red for ease of inspection
- Fulfills residential and commercial firestopping code requirements
- Meets ASTM-E814/UL 1479 test standards
- Resumes integrity for 1 & 2 hour fire rated assemblies

PART NO.	DESCRIPTION	CTN QTY
J40284	5 gallons	1
J40286	10.3 oz. tube	12

Fire Seal-136 Firestopping Caulk



- Resumes integrity of fireblocks 1 & 2 family construction
- Meets ASTM-E136 test standards
- Fulfills all residential fireblocking code requirements

PART NO.	DESCRIPTION	CTN QTY
J40287	10.3 oz. tube	12

Putty Knives



PART NO.	DESCRIPTION	CTN QTY
K50015	1 1/4" putty knife	1
K50016	3" putty knife	1

PlumBest Handi-Plug



- Combination test plug and stub-out for drop eared ell
- No tools required - manual installation allows for no time wasted applying and removing thread tape after each use! Cost-effective, too!
- No thread seal required
- Reusable - long lasting
- Smooth at thread end for easy plastering
- Time and labor savings

PART NO.	DESCRIPTION	CTN QTY
H54050	1/2" MIP Handi-Plug	25

Handicap



- No tools required - manual installation allows for no time wasted applying and removing thread tape after each use! Cost-effective, too!
- Reusable - long lasting
- Caps and 1/2" male thread for testing

PART NO.	DESCRIPTION	CTN QTY
H54100	1/2" FIP Handicap	1

Lumber Crayon



- Fade-proof, waterproof and smear-proof
- Will work on wet or dry wood, metal and concrete
- 4 1/2" long by 1/2" diameter
- CARTON QUANTITIES ONLY

PART NO.	DESCRIPTION	CTN QTY
J40350	Black lumber crayon	12
J40351	Yellow lumber crayon	12
J40352	Red lumber crayon	12
J40353	Blue lumber crayon	12

Carpenters Pencil



- Flat black lead makes wood marking crisp and accurate
- Long-lasting and easy sharpening

PART NO.	DESCRIPTION	CTN QTY
J40360	Carpenters pencil	12

Carpenters Pencil Sharpener



- Suitable for all kind of carpenter's pencils
- Candy jar display (60 ct.)

PART NO.	DESCRIPTION	CTN QTY
J40361	Carpenters pencil sharpener	60

Marking Products



- High-performance industrial marking products
- Permanent paint
- Quick drying



PART NO.	DESCRIPTION	CTN QTY
J40330	Dura Ink 15 Marker Red	72
J40331	Dura Ink 15 Marker Black	72
J40332	Dura Ink 25 Marker Black	48
J40333	Dura Ink 55 Marker Red	48
J40334	Dura Ink 55 Marker Black	48
J40335	Dura Ink 200 Marker Black	24
J40336	Paint Marker White	48
J40337	Paint Marker Yellow	48
J40338	Paint Marker Red	48
J40339	Paint Marker Black	48
J40340	Paint Marker Blue	48
J40341	Paint Marker Display	1
J40342	Round Counter Display Black	1
J40343	Round Counter Display Red/Black	1

Industrial Choice Precision-Line Inverted Marking Paint



- Features a distance tip for easy-to-read, bright, vivid markings
- Marks more linear feet than the competition
- Virtually no overspray
- Fast-drying and non-clogging
- Can be applied down to 25°F
- Dries in 5 minutes or less
- Easy-to-use, spray through cap guaranteed not to clog
- "No Mess" spray tip keeps paint off finger
- Locking tip keeps tip from popping off
- Best resistance to premature chalking and fading
- CARTON QUANTITIES ONLY
- GROUND TRANSPORTATION ONLY

PART NO.	DESCRIPTION	CTN QTY
J40380	White marking point	12
J40381	Yellow marking point	12
J40382	Red marking point	12
J40383	Blue marking point	12
J40384	Green marking point	12
J40385	Orange marking point	12
J40387	Pink marking point	12

Paint Spotter Hand-Help Wand



- For quick, easy one-hand application of marking point

PART NO.	DESCRIPTION	CTN QTY
J40386	Paint spotter	1

Whitlam "Blue Magic" Pipe Joint Compound



- ORM-D
- NSF Approved
- Slow set
- Meets FED spec TT-S-1732
- Use on plastic and metal threads
- CARTON QUANTITIES ONLY

PART NO.	DESCRIPTION	CTN QTY
S95710	1/2 pint brush top can joint compound	24
S95711	1 pint brush top can joint compound	12
S96014	1/4 pint joint compound	24
S96016	1 quart pipe joint compound	12

Whitlam Seal Unyte



- Hard set
- Dark gray
- Semi-paste
- Use on all metal threaded connections and flanges

PART NO.	DESCRIPTION	CTN QTY
S95012	1/2 pint Whitlam seal unyte	24
S95014	1/4 pint Whitlam seal unyte	24
S96012	1 pint Whitlam seal unyte	12
S95016	1 quart Whitlam seal unyte	12

Whitlam "Select Unyte" Teflon Pipe Joint Compound



- ORM-D
- NSF Approved
- Soft set, white virgin teflon (PTFE)
- Use on plastic and metal threads
- For use on air, steam, petroleum, water, gas and chemical lines
- CARTON QUANTITIES ONLY

PART NO.	DESCRIPTION	CTN QTY
S95712	1/2 pint brush top can joint compound	24
S95713	1 pint brush top can joint compound	12

Whitlam "Green Blaster" Drain Opener



- ORM-D
- Dry granular composition for clearing grease, hair and other organic matter from drains
- Non-acid - safe for chrome, polished brass, plastic and fixtures
- Safe for septic tanks
- CARTON QUANTITIES ONLY
- GROUND TRANSPORTATION ONLY

PART NO.	DESCRIPTION	CTN QTY
S95714	1 lb. canister drain opener	24
S95715	2 lb. canister drain opener	12

Slic-tite® Heavy Duty Thread Sealing Compound



- Working pressures: to 10,000 psi (liquids), 3,000 (gases)
- Temp: -50°F to +500°F
- Use for threaded connections on steel, aluminum, brass, PVC, CPVC & ABS



PART NO.	DESCRIPTION	CTN QTY
S95011	8 fl. oz. Slic-tite® HD Thread Sealing Compound	24

Cool Gel®



- Protects surfaces and components from heat damage such as piping, drywall, and shower valves
- Used for any soldering or brazing job
- Safe, non-toxic, and harmless to the skin
- Will evaporate in 24-48 hrs. eliminating cleanup
- Unique gelling formula sticks to any surface without dripping or running off



PART NO.	DESCRIPTION	CTN QTY
S95100	1 qt. Cool Gel®	12
S95101	1 pt. Cool Gel®	24

Visu-Glow Leak Detector



- Fluorescent gas leak detector



PART NO.	DESCRIPTION	CTN QTY
S95200	8 oz. Visu-Glow Leak Detector	24

Floweazy Drain Cleaner



- Organic digester; biodegradable
- Dissolves grease, hair, sanitary napkins, sludge, soap and paper
- Environmentally safe
- CARTON QUANTITIES ONLY
- ORM-D (S95701/S95703)
- HAZMAT (S95705)

PART NO.	DESCRIPTION	CTN QTY
S95701	1 pint Floweazy drain cleaner	12
S95703	1 quart Floweazy drain cleaner	12
S95704	1/2 gallon Floweazy drain cleaner	6
S95705	1 gallon (HAZMAT) Floweazy drain cleaner	4

A.C. Coil Cleaner



- No fumes
- Professional strength - non-corrosive citric acid formula
- Ready to use - No mixing, no measuring, no mess
- Convenient trigger sprayer
- Removes grease, oil and heavy soil deposits
- Color coded liquid for quick and easy product recognition
- CARTON QUANTITIES ONLY
- ORM-D

For Interior Coils

PART NO.	DESCRIPTION	CTN QTY
S95721	1 quart (RTU) A.C. Coil Cleaner	12

For Exterior Coils (also available as a concentrate)

PART NO.	DESCRIPTION	CTN QTY
S95722	1 gallon (Conc) Cond. Coil Cleaner	4
S95725	1 gallon (RTU) Cond. Coil Cleaner	4

Plumber's Faucet And Valve Grease



- Lubricates faucet stems, threads, o-rings, packing, gaskets
- Resists high temperatures
- Counter display
- CARTON QUANTITIES ONLY

PART NO.	DESCRIPTION	CTN QTY
S95709	2.0 fl.oz. tins in counter display	12

Plumber's Putty



- Use on sinks, strainers, faucets and other fixtures wherever a non-drying watertight seal is needed
- DO NOT USE ON MARBLE OR PLASTIC!!!
- Meets Federal Specification TT-P-1536
- CARTON QUANTITIES ONLY

PART NO.	DESCRIPTION	CTN QTY
P40014	14 oz. putty	24
P40080	5 lb. putty	6

Plumber's Epoxy Putty



- Seal leaks in sink traps, water tanks, pipe joints, drain leaks and radiators
- Stop leaks in pools and drain lines
- Repair cracked porcelain wall tiles, floor tiles and fixtures
- CARTON QUANTITIES ONLY

PART NO.	DESCRIPTION	CTN QTY
P40004	4 oz. Epoxy putty tubes in counter display	12

Plumber's Goop Adhesive



- 3.7 oz. tube
- Watertight bond for use on PVC, tile or porcelain
- CARTON QUANTITIES ONLY
- ORM-D

PART NO.	DESCRIPTION	CTN QTY
J45100	3.7 oz. tube plumber's goop adhesive	12

2CanCaddy™



- Grab and go handle
- Special velcro strap to keep cans organized and secure
- Works well with all size cans up to 32 oz.
- Made of extremely durable polymer
- Easily cleans, stain resistant and virtually indestructible
- Perfect for...Plumbers, Electricians, Painters & More

PART NO.	DESCRIPTION	CTN QTY
S95015	2CanCaddy™	12

Steel Nipple Caddy Tray



- Steel construction
- Baked epoxy finish
- Push away handles
- Nipple storage range (close-6")

PART NO.	SIZE	DIMENSIONS	CAPACITY	CTN QTY
N70050	1/2"	10 1/2" x 7" x 6 1/2"	77 pieces	1
N70075	3/4"	12 1/2" x 7" x 6 1/2"	66 pieces	1
N70016	1"	14 1/8" x 7 3/4" x 6 1/2"	50 pieces	1
N70020	1 1/4"	18" x 8" x 6 1/2"	40 pieces	1
N70024	1 1/2"	19 1/2" x 6 1/2" x 6 1/2"	30 pieces	1
N70032	2"	23 7/8" x 8 1/2" x 6 1/2"	27 pieces	1

1/2" & 3/4" Combo Nipple Caddy



- Holds 39 1/2" x close-6"
- Holds 33 3/4" x close-6"
- Steel construction with baked epoxy finish
- Fold over handle

PART NO.	DIMENSIONS	DESCRIPTION	CTN QTY
N70575	12 1/8" x 7" x 6 1/2"	Combo Caddy	1

Fitting Tote Tray



- Excellent for copper and PVC fittings
- Steel construction with baked epoxy finish
- Inside compartments measure 4 7/8" x 4 7/8" x 3 7/8"
- 8 compartments
- Fold over handle

PART NO.	DIMENSIONS	DESCRIPTION	CTN QTY
N70500	20" x 10 1/2" x 5"	Fitting Caddy	1

Plastic Nipple Caddy



- High impact plastic
- Strong and lightweight
- Will not rust or corrode
- Nipple storage range (close-6")

PART NO.	SIZE	DIMENSIONS	CAPACITY	CTN QTY
N70150	1/2"	11" x 7 1/2" x 6 1/2"	77 pieces	4
N70175	3/4"	13 1/4" x 7 7/8" x 6 1/2"	66 pieces	4
N70200	1"	14 3/4" x 8 1/8" x 6 1/2"	50 pieces	4
N70250	1 1/2"	21" x 7" x 6 1/2"	30 pieces	2
N70300	2"	23 1/4" x 8 1/2" x 6 1/2"	27 pieces	2

Utility Tote Tray



- Lightweight, durable, high impact plastic

PART NO.	DIMENSIONS	DESCRIPTION	CTN QTY
T60100	10" x 15" x 5"	Tote tray	12

Tool Totes



- High density polyethylene construction resistant to acids, chemicals, oils and glues
- Removable dividers
- Reinforced metal handle
- Made in the U.S.A.

MADE IN THE USA

PART NO.	DESCRIPTION	CTN QTY
T60121	12" x 24" x 6" deep tray with 4 dividers	5
T60122	9" x 15" x 5" deep tray with 4 dividers	10
T60123	9" x 15" x 3" deep tray with 4 dividers	10
T60124	12 1/2" x 18" x 4 1/2" deep tray	5
T60125	Extra dividers for T60121	4
T60126	Extra dividers for T60122	4
T60127	Extra dividers for T60123	4

Bucket Caddies



- 5 gallon high-impact red plastic bucket holds 4 combinations of trays- 3 large; 6 small; 1 large with 4 small; and 2 large with 2 small
- All trays have 4 sections; use tray subdividers to increase small tray capacity up to 8 sections
- Tool apron fits 5 and 3 1/2" gallon buckets; apron straps on or can be permanently secured (hardware included)
- Made in the U.S.A.

MADE IN THE USA

PART NO.	DESCRIPTION	CTN QTY
T60101	5 gallon bucket with 6 small trays	8
T60102	5 gallon bucket with 1 large tray & 4 small trays	8
T60103	Large trays (4 1/2" deep)	3
T60104	Small trays (2 1/2" deep)	6
T60105	Lid for 5 gallon bucket	1
T60106	5 gallon bucket only	1
T60107	Subdividers for small trays (4 pack)	1
T60108	20-pocket tool apron	1
T60110	5 gallon bucket with 2 large and 2 small trays	1
T60111	5 gallon bucket with 3 large trays	1

Work Gloves

BROWN JERSEY GLOVE

- 100% Brown cotton
- One size fits all
- Knit wrist
- 8 ounce



G50200
G50210

LEATHER PALM WORK GLOVE

- Split leather palm, thumb, fingers and knuckle
- 100% cotton back and liner
- Safety cuff



G50204
G50214

COTTON GLOVES

with Rubber Grippers or Palms

- Durable 100% cotton canvas
- No-slip grip dots or rubber on palm and fingers
- One size fits all
- Knit wrist



G50205
G50206

DRIVERS' STYLE LEATHER GLOVES

- Durable and long lasting - conforms to your hand with time
- Grain leather glove
- Elastic cuff



G50208
G50218

• CARTON QUANTITIES ONLY

Carded for Display (Priced per Pair)

PART NO.	DESCRIPTION	CTN QTY
G50200	Brown cotton jersey	12
G50204	Leather palm low safety cuff	12
G50208	Drivers' style leather	12

Display Carton Display-Each pair carded (Priced per Pair)

PART NO.	DESCRIPTION	CTN QTY
G50210	Brown cotton jersey	216 pair
G50214	Leather palm low safety cuff	96 pair
G50218	Drivers' style leather	48 pair

Special Use Gloves-Bulk Only (Priced per Pair)

PART NO.	DESCRIPTION	CTN QTY
G50205	White cotton with rubber grippers	12
G50206	White cotton with rubber palms	12

All Purpose Latex Palm/Mesh Back Gloves



- Durable
- Excellent in wet conditions
- Protects hands during rugged jobs
- CARTON QUANTITIES ONLY

PART NO.	DESCRIPTION	CTN QTY
G50202	Latex palm/mesh back gloves	12

Vinyl Gloves



- 5 mil.
- One size fits all
- Lightly powdered
- 100 reversible gloves (50 pair)

PART NO.	DESCRIPTION	CTN QTY
G50250	100 vinyl gloves	1

Vinyl Disposable Gloves



- One size fits all
- Ready to Hang or Place on Shelf

PART NO.	DESCRIPTION	CTN QTY
G50251	20 pack disposable gloves	20

Nemesis® Safety Glasses



Display



- Soft-touch temples
- Light weight construction
- Single-lens wrap-around protection
- 99.9% UV resistant
- Meets ANSI Z87.1 + standards

Glasses

PART NO.	DESCRIPTION	CTN QTY
G30011	Nemesis® Clear	12
G30012	Nemesis® Smoke Mirror	12
G30013	Nemesis® Blue Mirror	12
G30014	Nemesis® Camo/Bronze	12

Display

PART NO.	DESCRIPTION	CTN QTY
G30000	Includes: 12 pair Smoke Mirror, 6 pair Blue Mirror, 6 pair Clear, Free Display	1
G30030	Includes: 12 pair Camo/Bronze, Free Display	1

Hellraiser Safety Glasses



Clear



Smoke



Blue Mirror

PART NO.	DESCRIPTION	CTN QTY
G30015	Hellraiser clear safety glasses	12
G30016	Hellraiser smoke safety glasses	12
G30017	Hellraiser blue mirror safety glasses	12

Visio Safety Glasses



- One-piece frame
- Adjustable temples
- Sleek, lightweight and comfortable
- Meets ANSI z87.1

PART NO.	DESCRIPTION	CTN QTY
G30003	Visio clear safety glasses	12
G30004	Visio blue mirror safety glasses	12
G30005	Visio silver indoor/outdoor glasses	12

Clear Safety Goggles



- Direct ventilation
- Economical protection

PART NO.	DESCRIPTION	CTN QTY
G30001	Clear safety glasses	200

Dust Masks



- Disposable
- Non-toxic

PART NO.	DESCRIPTION	CTN QTY
G30021	Dust mask	50/box

Safety Face Shield With Headgear



- High performance ratchet headband
- Crown assembly pivots up
- Low-riding nape strap for firm fit

PART NO.	DESCRIPTION	CTN QTY
G30008	Safety face shield with headgear	10

Safety Hats



- Fits sizes 6 1/2- 8
- Meets ANSI z89.1 requirement
- Short peak design creates greater upward visibility
- Comfortable 4-point suspension with terrycloth sweatbands
- Low nape strap and rain trough features
- Universal slots to accommodate hearing, welding and face shield accessories

PART NO.	DESCRIPTION	CTN QTY
H40001	Yellow with 4-point pin lock suspension	12
H40002	White with 4-point pin lock suspension	12
H40003	Yellow with 4-point ratchet suspension	12
H40004	White with 4-point ratchet suspension	12

Knee Pads



K01120

K012000

- Lightweight and water-resistant
- Comfortable while kneeling, standing or walking
- Won't pinch or bind behind knee
- Soft, breathable inner lining for coolness and comfort
- Velcro closures on straps
- Heavy duty knee cap on K012000

PART NO.	DESCRIPTION	CTN QTY
K01120	Heavy duty foam economy	1 pair
K012000	Heavy duty knee cap	1 pair

Industrial Back Supports



- Adjustable, comfortable support promotes proper lifting techniques

PART NO.	DESCRIPTION	CTN QTY
S49601	Medium 33-38" waist	2
S49602	Large 39-44" waist	2
S49603	X-Large 45-49" waist	2

Ready Fit Corded Ear Plugs



- Display box included

PART NO.	DESCRIPTION	CTN QTY
E85000	Ready fit corded ear plugs	100

Hornet & Wasp Spray



- Long range spray- shoots a stream up to 20 feet, reaching nests far above ground, letting you keep a comfortable distance from the nest
- Contains no CFCs which deplete the ozone layer
- GROUND TRANSPORTATION ONLY
- CARTON QUANTITIES ONLY
- ORM-D

PART NO.	DESCRIPTION	CTN QTY
J40393	20 oz. can hornet & wasp spray	12

Protective Shoe Covers



- Fits easily over work shoes and boots
- Elastic top allows fit up to size 12
- Keeps dirt and grime outside
- Carton holds 200 pieces (100 pair)
- SOLD BY FULL CARTON OR 10 PAIR PACK

PART NO.	DESCRIPTION	CTN QTY
B05010	Protective shoe covers	1
B05011	Protective shoe covers (10 pair)	1

Shubee Shoe Covers



- Dark blue
- Fits easily over work shoes and boots
- Elastic top allows fit up to size 12
- Keeps dirt and grime outside
- Carton holds 150 pair

PART NO.	DESCRIPTION	CTN QTY
B05015	Shubee Shoe Covers	1

Disposable Coverall



- Tear and puncture resistant
- Use when comfort and coolness is a priority

PART NO.	DESCRIPTION	CTN QTY
B05020	Large disposable coverall	25
B05021	X-large disposable coverall	25

Cable Ties



Natural Color



Black

- Standard size
- CARTON QUANTITIES ONLY
- Nylon

Natural Color		
PART NO.	DESCRIPTION	CTN QTY
J40107	7" long (1/16" - 1 3/4")	100
J40111	11" regular (1/16" - 3")	100
Black		
PART NO.	DESCRIPTION	CTN QTY
J40115	15" (5/16")	100

Cable Tie Assortment



- 400 pieces in kit: 100 pieces of 11", 100 pieces of 7", 200 pieces of 4"

PART NO.	DESCRIPTION	CTN QTY
J40108	Cable tie assortment	1

Duct Straps



- HVAC application
- CARTON QUANTITIES ONLY
- Natural nylon
- Up to 10" diameter

PART NO.	DESCRIPTION	CTN QTY
J40134	34" Duct straps	50

Heavy Duty Utility Straps



- Made in the USA
- Plated S-hooks
- Meets or exceeds ASTM standards
- CARTON QUANTITIES ONLY
- Weather and wear resistant

MADE IN THE USA

PART NO.	DESCRIPTION	CTN QTY
S20015	15" Heavy duty utility strap	25
S20021	21" Heavy duty utility strap	25
S20031	31" Heavy duty utility strap	25
S20041	41" Heavy duty utility strap	25

Ratchet Tie Down Strap



- 1" wide/400 lb. working load limit
- Comfort grip handles
- Weather and corrosion resistant
- PVC coated hooks that will not scratch
- Cut and abrasion resistant webbing

PART NO.	DESCRIPTION	CTN QTY
S20300	1" x 16' Ratchet tie down strap	1

Camouflage Strap With Hooks



- 1" wide/300 lb. working load limit
- 2 hooks included with each strap; pack of 4 ratchet straps

PART NO.	DESCRIPTION	CTN QTY
S20301	1" x 9' Camo strap with hooks	1

Ratchet Strap With Step Release J-Hooks



- 2" wide/ 3,333 lb. working load limit
- Step by step release action
- Gradually releases tension with double J-hook
- Flex grip handle

PART NO.	DESCRIPTION	CTN QTY
S20302	2" x 27' Ratchet strap with step release J-hooks	1

Cam Strap



- 1" wide / 750# test nylon straps
- All colored straps and threads are UV resistant
- Straps are secured by a heavy duty zinc plated metal cam buckle, which will not slip even in wet conditions
- Ideal for handling loads for all kinds of contractor needs
- Call for details about Cam Strap Display
- S20999 Display includes: One 2' x 2' peg board, Six peg hooks and reorder cards, 1 Display header card, Includes an assortment of 72 straps

PART NO.	DESCRIPTION	CTN QTY
S20100	1" x 2' Black	12
S20101	1" x 4' Red	12
S20102	1" x 6' Yellow	12
S20103	1" x 8' Green	12
S20104	1" x 10' Blue	12
S20105	1" x 12' Purple	12
S20106	1" x 20' Black	12
S20999	Cam Straps Display	1

Twin Packs

PART NO.	DESCRIPTION	CTN QTY
S20200	1" x 2' Black - Twin Pack	1
S20201	1" x 4' Red - Twin Pack	1
S20202	1" x 6' Yellow - Twin Pack	1
S20203	1" x 8' Green - Twin Pack	1
S20204	1" x 10' Blue - Twin Pack	1

3-N-1 Tubing Bender



- For 1/4", 5/16" or 3/8" tubing

PART NO.	DESCRIPTION	CTN QTY
T50001	3-N-1 tubing bender	1

Spring Tubing Bender



- Spring prevents collapse of the wall at bending point
- Allows fast free-form bending of soft copper and aluminum tube

PART NO.	DESCRIPTION	CTN QTY
J41030	3/8" spring tubing bender	1
J41031	1/2" spring tubing bender	1
J41032	5/8" spring tubing bender	1

WD-40® Lubricant



- Cleans
- Protects against rust and corrosion
- Lubricates
- ORM-D
- Penetrates stuck metal parts
- CARTON QUANTITIES ONLY
- Displaces moisture
- GROUND TRANSPORTATION ONLY

PART NO.	DESCRIPTION	CTN QTY
S95700	8 oz. can lubricant	12

Neon Chalk Lines



Starrett®

- Push-button line release
- Can be used as a plumb bob
- 3 1/2 times faster reel

PART NO.	DESCRIPTION	CTN QTY
J40090	100' orange chalk line	6
J40092	8 oz. blue chalk	6

Soap Stones And Holders



- ROUND- Pen size lightweight aluminum holder with built-in chuck
- FLAT- Stainless steel spring tension with locknut
- Soap stones sold in carton quantities only

PART NO.	DESCRIPTION	CTN QTY
J40060	Round soap stone holder	6
J40061	Flat soap stone holder	6
J40062	Round soap stone	144/box
J40063	Flat soap stone	144/box

Brass Plumb Bob



- Solid brass
- Removable tip

PART NO.	DESCRIPTION	CTN QTY
J42008	8 oz. brass plumb bob	1
J42012	12 oz. brass plumb bob	1

Garden Hoses



- G04001:
- 500 PSI burst strength
 - Kink-free construction
 - Heavy-duty solid brass nickel plated coupling
 - Built-in spring at faucet end to prevent hose damage
 - Nylon reinforced

- G04002 and G04000:
- 300 PSI burst strength
 - Solid brass couplings
 - Reinforced green nylon construction

PART NO.	DESCRIPTION	CTN QTY
G04001	5/8" x 60' (500 PSI) garden hose	6
G04002	5/8" x 50' (300 PSI) garden hose	6
G04000	5/8" x 75' (300 PSI) garden hose	6

Caution Tape



- Black print on safety yellow
- 3 mil thickness

PART NO.	DESCRIPTION	CTN QTY
J43300	3" x 300'	10
J43310	3" x 1000'	6

Gas Line Marking Labels



- Yellow self adhesive stickers
- Clearly identifies gas lines from other utility and water lines
- 100 labels per roll

PART NO.	DESCRIPTION	CTN QTY
J40481	2 PSI gas line stickers	1
J40482	Gas line stickers	1

E-Z Light



- Extendable for lighting flames from a distance
- Safe and convenient for torch, fireplace, or any hard-to-reach area

PART NO.	DESCRIPTION	CTN QTY
J40450	E-Z Light	1

E-Z Reach



- Extendable, magnetized arm for easy retrieval of small metal parts
- Great for shop or job site

PART NO.	DESCRIPTION	CTN QTY
J40451	E-Z Reach	1

24" Grab-It Tool



- Makes hard-to-reach areas accessible using retractable fingers

PART NO.	DESCRIPTION	CTN QTY
J40020	24" Grab-it tool	6

Steel Wool



- Packaged 16 pads per bag, 12 bags per carton
- Priced per bag

PART NO.	DESCRIPTION	CTN QTY
B29300	Size 00 steel wool	12
B29310	Size 0 steel wool	12

Plumber's Candle



PART NO.	DESCRIPTION	CTN QTY
J46118	1 1/8" x 5"	120

Copper Cleaning Pads



- Reusable
- Use wet or dry - will not clog
- Nylon impregnated fine maroon
- Good general cleaner for removing rust, corrosion, etc.
- Deoxidizes and cleans copper tube and fittings for soldering
- CARTON QUANTITIES ONLY

PART NO.	SIZE	CTN QTY
B29400	4" x 6 1/4" x 1/4"	10

Acid Brushes



- Tin handle
- CARTON QUANTITIES ONLY

PART NO.	SIZE	CTN QTY
B29700	3/8" x 6"	144
B29701	1/2" x 6"	144
B29702	9/16" x 6"	144
B29699	1/4" x 3"	144

Paint And Dope Brush



- Natural bristles
- CARTON QUANTITIES ONLY
- Ideal for use with pipe cleaners, thread cutting oil, paint, pipe dope

PART NO.	SIZE	CTN QTY
B29801	1"	36
B29802	2"	24

Wire Brush



- For cleaning rough surfaces
- Stiff steel wire bristle
- Polished hardwood handle
- CARTON QUANTITIES ONLY

PART NO.	SIZE	CTN QTY
B29900	1"	6

Lead Joint Runners



PART NO.	DESCRIPTION	CTN QTY
L42011	#1 - 2" - 4" pipe size	10
L42012	#2 - 4" - 6" pipe size	10
L42013	#3 - 6" - 10" pipe size	5
L42014	#4 - 10" - 14" pipe size	1
L42015	#5 - 16" - 20" pipe size	1
L42016	#6 - 20" - 24" pipe size	1
L42017	#7 - 24" - 30" pipe size	1
L42018	#8 - 30" - 36" pipe size	1
L42019	#9 - 36" - 42" pipe size	1
L42023	#10 - up to 48" pipe size	1

Magnetic Polycast Post Level



- Magnetic edge and stretchable strap make this level easy to use
- Quickly and accurately establish level or plumb on posts and pipes
- Made of sturdy polycast material

PART NO.	DESCRIPTION	CTN QTY
J40103	Magnetic polycast post level	6

Torpedo Level



- Manufactured to rigid requirements
- Professional quality
- Aluminum construction
- Magnetic sides
- 7 1/2" length



PART NO.	DESCRIPTION	CTN QTY
J40100	Torpedo level	1

Cast Magnetic Level with Front Vial Viewer



- Saves time and money
- Eliminates neck and back strain
- Large solid acrylic vials
- Magnetic
- Epoxy set vials
- V-groove for pipes
- Accuracy: 0.5 mm / M-0.029
- Integrated Euroslot hanging hole

PART NO.	DESCRIPTION	CTN QTY
J42100	Cast iron magnetic level	1

Plastic Magnetic Level



- Has front vial viewer
- Saves time and money
- Eliminates neck and back strain
- Internal aluminum frame for accuracy and strength
- Magnetic
- Integrated Euroslot hanging hole

PART NO.	DESCRIPTION	CTN QTY
J42101	10" Plastic magnetic level	1

Top Grade Gradient Level



- The ultimate plumbing level
- Set accurate slopes of 1 and 2 percent
- Includes conversion of pitch and slope
- Accuracy: 0.5mm/ M-0.029" on all vials
- Length: 60cm/24"
- U.S. patent 6,209,211

PART NO.	DESCRIPTION	CTN QTY
J42200	24" length gradient level	1

Industrial Swivel-Lite Flashlights



F20016



F20017

- Contractor grade construction
- Sure grip rubber handles

PART NO.	DESCRIPTION	CTN QTY
F20016	Flashlight for AA batteries	6
F20017	Flashlight for D batteries	6

Rayovac Floating Lantern & Battery



F20003



F20004



F20005

- 6-volt F20004 battery included
- Heavy duty battery priced each

PART NO.	DESCRIPTION	CTN QTY
F20003	Floating lantern with battery	1
F20004	6 volt spring top - battery only	12
F20005	6 volt screw top - battery only	12

Rayovac Industrial Flashlights



- Yellow flashlights with ring hangers

PART NO.	DESCRIPTION	CTN QTY
F20001	2 cell D size flashlight	6
F20002	3 cell D size flashlight	6

4 D/6 Volt Swivel-Lite



- Contractor grade construction
- Krypton bulb, spare bulb holder
- Floats in water (with beam up)
- Long range beam
- 45° swivel for hands-free use
- Comfort-grip handle, push-button switch
- No batteries included
- Can use 6V lantern battery for additional power

PART NO.	DESCRIPTION	CTN QTY
F20018	4D/ 6-Volt Swivel-Lite	1

Sportsman L.E.D. Head-Lite



- New technology unique 3-way hands-free L.E.D. system
- Close range use super white L.E.D., "Night vision" 2 super red L.E.D., Long range beam-krypton bulb
- Batteries last 20 times longer with L.E.D. bulbs than normal bulbs
- Rubber spot-flood reflector, head rotates 180° compact design, comfort-grip band
- Weatherproof, heavy duty construction

PART NO.	DESCRIPTION	CTN QTY
F20019	Sportsman L.E.D. Head-Lite	1

Rayovac Heavy Duty Industrial Batteries



- List price is for each battery
- PACK QUANTITIES ONLY

PART NO.	DESCRIPTION	CTN QTY
F20006	Heavy duty C batteries	6
F20007	Heavy duty D batteries	6

Rayovac Heavy Duty Alkaline Industrial Batteries



- List price is for each battery
- PACK QUANTITIES ONLY

PART NO.	DESCRIPTION	CTN QTY
F20012	AAA alkaline batteries	8
F20008	AA alkaline batteries	6
F20009	9 volt alkaline batteries	6
F20010	C alkaline batteries	6
F20011	D alkaline batteries	6

Flashlight Replacement Bulbs



- Two bulbs per card

PART NO.	DESCRIPTION	CTN QTY
F20013	Bulb for F20001	1
F20014	Bulb for F20002	1
F20015	Bulb for F20003	1

Cutting Oil



- Medium brown color

PART NO.	DESCRIPTION	CTN QTY
J45005	Premium all-purpose oil (gallon)	6

Wypall® Waterless Hand Wipes



- 10 x 12 pre-moistened towels; 50 count
- Lower price per tub
- Conveniently sized tub
- All of the towels can be used before they dry out
- CARTON QUANTITIES ONLY

PART NO.	DESCRIPTION	CTN QTY
B05007	50-count dispenser tub	8
B05008	Wypall display (32 tubs)	1

Wypall® Teri® Towels



- Strong and durable, wet or dry
- 125 reusable sheets per box-equivalent to 18 lbs. of rags
- Reinforced HYDROKNIT® provides extra scrubbing power
- CASE QUANTITIES ONLY



PART NO.	DESCRIPTION	CTN QTY
B05003	9 3/4" x 16 3/4" x 125 sheets	10

Wypall® Waterless Hand Wipes



- Full-sized pre-moistened hand towels- smooth for wiping on one side, tough for scrubbing on the other
- Natural d'limonene cleaning agent tough on grease, grime, ink & paint
- CASE QUANTITIES ONLY

PART NO.	DESCRIPTION	CTN QTY
B05002	12" x 12" x 75 sheets	6

Box of Rags



- Colored cotton sweatshirt material
- 100% recycled
- Pull out dispensing

PART NO.	DESCRIPTION	CTN QTY
B05001	4 lb. box of rags	1

Poly Sheeting



- Clear
- 4 mil super tough plastic
- Hundreds of uses
- Made in the U.S.A.



PART NO.	DESCRIPTION	CTN QTY
S08100	8' x 100' poly sheeting	1
S10100	10' x 100' poly sheeting	1
S12100	12' x 100' poly sheeting	1

Cotton Plumbers Handy Towels



- 100% cotton heavy duty shop towels are washable, reusable & nonabrasive
- Ideal for cleaning hands, wiping spills, removing grime from tools & parts
- 12 towels per bag

PART NO.	DESCRIPTION	CTN QTY
B05004	Plumbers handy towels	12

Commercial Sponges



- Commercial grade cellulose sponges- made to last!
- Deeply textured top makes cleanup easier
- Made in the U.S.A.



DIMENSIONS	
S50001	6 3/4" x 4 1/2" x 1 1/4"
S50002	8" x 4 1/2" x 1 1/4"

PART NO.	DESCRIPTION	CTN QTY
S50001	Medium Cellulose sponge	24
S50002	Large Cellulose sponge	24

Plastic Drop Cloth



- Medium duty 1 mil plastic
- Convenient pleat fold pack design
- Protects furniture, appliances and carpets

PART NO.	DESCRIPTION	CTN QTY
D50000	9' x 12' plastic drop cloth	1

Trash Bags



G02042



G02033

- Hundreds of uses
- Keep the jobsite clean

PART NO.	DESCRIPTION	CTN QTY
G02042	42 gallon 3 mil. / 10 per bag	6
G02033	33 gallon .95 mil / 40 per box	6

Spray Bottle



- Economical to use for leak testing when filled with soapy water
- Clear bottle with various color tints based on availability

PART NO.	DESCRIPTION	CTN QTY
B25001	16 oz. clear spray bottle	1

Gatorade



- Powder

PART NO.	DESCRIPTION	CTN QTY
G90001	2.5 gal. Lemon Lime Gatorade	32
G90002	2.5 gal. Orange Gatorade	32

Garbage Disposal Cords



• 16/3 gauge wire

E25015
E25016

E25017
E25018

PART NO.	DESCRIPTION	CTN QTY
E25015	3' straight disposal cord	12
E25016	6' straight disposal cord	12
E25017	3' angle disposal cord	12
E25018	6' angle disposal cord	12

Garbage Disposal Wiring Kits



- Complete with 3 wire nuts and connector coupling
- 16/3 gauge wire
- Polybagged

PART NO.	DESCRIPTION	CTN QTY
E25115	Kit for 3' cord w/ straight plug	6
E25116	Kit for 6' cord w/ straight plug	6
E25117	Kit for 3' cord w/ angle plug	6
E25118	Kit for 6' cord w/ angle plug	6

Screw-On Wire Connectors



- Clamshell Packaging
- Ready to Hang!

PART NO.	DESCRIPTION	CTN QTY
E25125	Gray	100
E25126	Blue	100
E25127	Orange	100
E25128	Yellow	100
E25129	Red	50

Leak Alert Water Detector



- Loud alarm sounds with direct water contact
- Floats and signals for up to 72 hours
- Fully automatic operation - no wiring required
- Low battery indicator for optimum safety and performance

PART NO.	DESCRIPTION	CTN QTY
L95400	Leak alert water detector	1

#		
2CanCaddy™	21	
3-N-1 Tubing Bender	24	
4-Way	1	
Countersunk Plug Wrench.....	2	
Key.....	1	
Plug Wrench.....	2	
P.O. Plug Wrench.....	1	
6-Way Countersunk Plug Wrench	2	
A		
A.C. Coil Cleaner	20	
Acid Brushes	26	
Acrylic Tub And Tile Caulk	18	
Adhesive, Plumber's Goop	21	
Air Pump	5	
Economy.....	5	
Angle Compression Stop Wrench	2	
Awl, Scratch	17	
B		
Back Supports, Industrial	23	
Bags, Trash	28	
Bar	11	
Digging/Tamping.....	11	
Gooseneck Wrecking.....	11	
Utility Pry.....	11	
Batteries	27	
Rayovac.....	27	
Heavy Duty Alkaline Industrial.....	27	
Heavy Duty Industrial.....	27	
Bibb Seat Tool Set	4	
Bit	18	
Holders.....	18	
Phillips.....	18	
Bottle, Spray	28	
Box of Rags	28	
Box Wrench	4	
Brass Plumb Bob	25	
Brush	5	
4-N-1 Copper Tube Fitting.....	5	
Acid.....	26	
Copper Fitting.....	5	
Female Copper Tube.....	5	
Paint And Dope.....	26	
Wire.....	26	
Bucket Caddies	21	
Bulbs, Flashlight Replacement	27	
C		
Cable Ties	24	
Assortment.....	24	
Caddies, Bucket	21	
Camouflage Strap With Hooks	24	
Cam Strap	24	
Candle, Plumber's	26	
Carpenters Pencil	19	
Sharpener.....	19	
Cast Magnetic Level with Front Vial Viewer	26	
Caulk	18	
Acrylic Tub And Tile.....	18	
Hi-Temp Red Silicone.....	18	
Latex.....	18	
PlumBest Silicone.....	18	
Siliconized Acrylic.....	18	
Caulking Tools	10, 18	
Broad Curve Nose.....	11	
Gun.....	18	
Gun, Professional.....	18	
Inside.....	10	
Outside.....	10	
Short Nose.....	10	
Caution Tape	25	
Chalk Lines, Neon	25	
Chisels	10	
Cold.....	10	
Coil Cleaner, A.C.	20	
Commercial Sponges	28	
Compression Sleeve Puller	3	
Adapter.....	3	
Cool Gel®	20	
Copper	5	
4-N-1 Tube Fitting Brush.....	5	
Cleaning Pads.....	26	
Female Tube Brush.....	5	
Fitting Brush.....	5	
Sizing Tool.....	12	
Swedge Tool.....	12	
Coverall, Disposable	23	
Crimping Tools	12	
Pex Crimp Set.....	12	
Polybutylene.....	12	
Curb Box Wrench	4	
Curved Jaw Tongue & Groove Pliers	17	
Cutting Oil	27	
D		
Deburring Tool	13	
Digging/Tamping Bar	11	
Disposable	22	
Coverall.....	23	
Vinyl Gloves.....	22	
Do All Plumbers Wrench	4	
Drain Cleaner, Floweasy	20	
Drain Opener	20	
Floweasy.....	20	
Whitlam "Green Blaster".....	20	
Drill Bits	13	
Carbide Tipped Masonry.....	13	
Straight Shank.....	14	
Drop Cloth, Plastic	28	
Duct Straps	24	
Dust Masks	23	
E		
Ear Plugs, Ready Fit Corded	23	
Extract-a-Drain Tub Drain Removal Tool	2	
E-Z	25	
Light.....	25	
Reach.....	25	
F		
Face Shield With Headgear, Safety	23	
Faucet	2	
Seat Repair Kit.....	2	
Seat Wrench.....	2	

Seat Wrench For Recessed Seats.....	2	I	
Faucet And Valve Grease, Plumber's	20	Industrial Back Supports	23
Faucet Handle Pullers	3	K	
E-ZEE Pull Deluxe.....	3	Key.....	1
Female Copper Tube Brush.....	5	4-Way.....	1
Files.....	16	Sillcock.....	1
Fire Seal-136 Firestopping Caulk.....	19	Knee Pads	23
Firestop 814+ Intumescent Firestopping Sealant.....	18	Knives.....	9
Flaring Tools.....	12	Deluxe Autolock Snap.....	9
Swing Release.....	12	Putty.....	19
Flashlights.....	27	Snap.....	9
Industrial Swivel-Lite.....	27	Utility.....	9
Rayovac Industrial.....	27	L	
Replacement Bulbs.....	27	LACO.....	15
Flint Striker.....	15	Cool Gel®.....	20
Three Flint Friction Lighter.....	15	Flux Paste.....	15
Floating Lantern & Battery.....	27	Flux-Rite 90® Flux.....	15
Floweazy Drain Cleaner.....	20	Marking Products.....	19
Flux Paste.....	15	Slic-tite® Heavy Duty Thread Sealing Compound.....	20
Flux-Rite 90® Flux.....	15	Visu-Glow Leak Detector.....	20
Freeze Fix Pipe Jackets.....	16	Latex Caulk.....	18
G		Lavatory Nut Removal Tool.....	2
Garbage Disposal.....	29	Lead Joint Runners.....	26
Cords.....	29	Leak Alert Water Detector.....	29
Wiring Kits.....	29	Leak Detector, Visu-Glow.....	20
Wrench.....	1	Levels.....	26
Garden Hoses.....	25	Cast Magnetic, with Front Vial Viewer.....	26
Gas Line Marking Labels.....	25	Magnetic Polycast Post.....	26
Gate Valve Key.....	12	Plastic Magnetic.....	26
Gatorade.....	28	Top Grade Gradient.....	27
Glasses, Safety.....	22	Torpedo.....	26
Hellraiser.....	22	Long Nose Pliers.....	17
Nemesis.....	22	Lubricant, WD-40®.....	25
Visio.....	22	Lumber Crayon.....	19
Gloves.....	22	M	
All Purpose Latex Palm/Mesh Back.....	22	Magnetic.....	17
Vinyl.....	22	Cast Level with Front Vial Viewer.....	26
Vinyl Disposable.....	22	Plastic Level.....	26
Work.....	22	Polycast Post Level.....	26
Goggles, Clear Safety.....	22	Power Nut Setters.....	17
Grab-It Tool.....	25	Torpedo Level.....	26
Gradient Level, Top Grade.....	27	MAPP Gas Cylinders.....	15
Griplock Tongue & Groove Water Pump Pliers.....	16	Marking Labels, Gas Line.....	25
H		Marking Paint, Industrial Choice Precision-Line Inverted.....	19
Hacksaw.....	9	N	
Blades.....	9	Neon Chalk Lines.....	25
Close Quarters.....	9	Nipple Caddy.....	
PlumBest.....	9	Combo.....	21
Handicap.....	19	Plastic.....	21
Handi-Plug, PlumBest.....	19	Steel Tray.....	21
Hand Wipes, Wypall Waterless.....	28	Nipple Extractors.....	13
Hats, Safety.....	23	And Screw Extractors.....	13
Head-Lite, Sportsman L.E.D.....	27	Internal Pipe.....	13
Hi-Temp Red Silicone Caulk.....	18	Sets.....	13
Hornet & Wasp Spray.....	23	"No Pinch" Pipe Wrench Pliers.....	16
Hose.....	5	Nut Driver.....	18
Garden.....	25	Nut Setters, Magnetic Power.....	17
High Pressure with Fitting.....	5	O	
Hydrostatic Pressure Pump.....	5	Offset Pliers.....	16
RP 30.....	5	Diagonal Cutting.....	16

Long Nose	16	Propane Cylinders.....	15
Slip Joint.....	16	Pumps.....	5
Oil, Cutting.....	27	Air.....	5
P		Economy Air	5
Packing Or Yarning Tools.....	10	Hydrostatic Pressure.....	5
Pads.....	23	RP 30 Hydrostatic Test	5
Copper Cleaning	26	Water	5
Knee.....	23	Putty.....	19
Paint.....	19	Knives.....	19
And Dope Brush.....	26	Plumber's.....	21
Marking, Industrial Choice Precision-Line Inverted	19	Plumber's Epoxy.....	21
Spotter Hand-Help Wand.....	19	R	
Phillips Bits.....	18	Radiator Spud Wrench	1
Pick.....	11	Rags, Box of.....	28
Mattock	11	Ratchet Strap.....	24
Railroad	11	Tie Down.....	24
Pipe Cutters.....	6	With Step Release J-Hooks.....	24
Heavy Duty PVC	6	Rayovac.....	27
Inside	6	Batteries	27
PlumBest E-Z Shear Inside.....	6	Heavy Duty Alkaline Industrial.....	27
Professional PVC.....	6	Heavy Duty Industrial	27
PVC.....	6	Floating Lantern & Battery.....	27
PVC One-Handed	6	Industrial Flashlights	27
Pipe Jackets, Freeze Fix.....	16	Ready Fit Corded Ear Plugs	23
Pipe Joint Compound.....	20	Removal Tool.....	2
Whitlam "Blue Magic"	20	Extract-a-Drain Tub Drain	2
Whitlam "Select Unyte" Teflon	20	Lavatory Nut.....	2
Pipe Plugs, Sure Sweat Dissolvable.....	16	Rod.....	11
Pipe Taps.....	14	Probing	11
Pipe Wrench.....	4	Steel Probing	11
Aluminum.....	4	Steel Probing, with Ball Point	11
Heavy Duty.....	4	Romax Press Tool.....	8
Plastic Drop Cloth.....	28	Compact Cordless	8
Plastic Magnetic Level.....	26	Pressliner Cordless	8
Pliers.....	16	Ruler, Wood Folding with Extension	15
Curved Jaw Tongue & Groove.....	17	S	
Long Nose	17	Safety.....	22
Offset Diagonal Cutting.....	16	Face Shield With Headgear	23
Offset Long Nose.....	16	Glasses	22
Offset Slip Joint.....	16	Hellraiser	22
Pipe Wrench, "No Pinch"	16	Nemesis	22
Slip Jaw	16	Visio	22
Smooth Jaw	16	Goggles, Clear.....	22
Smooth Jaw Tongue & Groove	17	Hats	23
Tongue & Groove.....	17	Saws.....	8
Water Pump	16	Cable.....	8
Water Pump, Griplock Tongue & Groove.....	16	Close Quarters Hacksaw	9
Plumb Bob, Brass.....	25	Drywall.....	8
Plumber's.....	20	E-Z Stroke Pipe.....	8
Candle	26	Hardwood 250 Speed Handsaw	8
Cotton Handy Towels.....	28	Jr. Plumber's.....	8
Epoxy Putty	21	PlumBest Hacksaw	9
Faucet And Valve Grease.....	20	PlumBest Plastic	8
Goop Adhesive	21	T-Handle Cable	9
Putty	21	Scratch Awl.....	17
Poly Sheeting.....	28	Screw and Nipple Extractors.....	13
Power Ship Augers.....	13	Screwdrivers.....	17
Press Tool.....	8	4 in 1	17
Romax Compact Cordless.....	8	6 in 1	17
Romax Pressliner Cordless.....	8	For # 8 And # 10 Screws	17

Spanner	17	Locking	15
Sealant, Silicone Tub And Tile	18	Long	14
Sheeting, Poly	28	Neon Precision	14
Shoe Covers	23	PlumbRule	14
Protective	23	Thread Sealing Compound, Slic-tite® Heavy Duty	20
Shubee	23	Tongue & Groove Pliers	17
Shovels	10	Top Grade Gradient Level	27
Economy	10	Torches	15
Fiberglass Handle	10	Pencil Flame	15
Long Handle Round Point Fiberglass	10	Uniweld	15
Premium Grade Wood Handle	10	Torpedo Level	26
Specialty	10	Totes	21
Silicone	18	Fitting Tray	21
Caulk	18	Tool	21
Tub And Tile Sealant	18	Utility Tray	21
Siliconized Acrylic Caulk	18	Towels	28
Sillcock Key	1	Cotton Plumbers Handy	28
Slip Jaw Pliers	16	Wypall Teri	28
Smooth Jaw Pliers	16	Trash Bags	28
Tongue & Groove	17	Tub And Shower Valve Wrench Set	1
Snips		Tubing Benders	24
Offset Aviation	9	3-N-1	24
Soap Stones And Holders	25	Spring	25
Socket Savers	6	Tubing Cutter	6
Solder	15	Copper	7
Phos-Copper Brazing Rod	15	Economy	7
Shield Protective Blanket	15	Mini	7
Silver	15	Quick Release	7
Spanner/Strainer Wrench	3	Ratcheting Handle Copper	7
Sponges, Commercial	28	Telescoping	7
Sportsman L.E.D. Head-Lite	27	Vinyl	6
Spray Bottle	28	U	
Spring Tubing Bender	25	Universal Drain Wrench	2
Spud	3	Utility Pry Bar	11
Adjustable, Strainer and	3	V	
Wrench	3	Vinyl Gloves	22
Wrench With Hinged Arm	3	Disposable	22
Steel Wool	26	W	
Strainer	3	Wasp & Hornet Spray	23
Adjustable, and Spud	3	Water Detector, Leak Alert	29
Plumb Easy Sink Wrench	4	Water Meter Keys	12
Wrench	3	Combo	12
Straps	24	Gate Valve Key	12
Cam	24	Water Pump	5
Camouflage, with Hooks	24	Pliers	16
Duct	24	WD-40® Lubricant	25
Heavy Duty Utility	24	Whitlam	20
Ratchet Tie Down	24	"Blue Magic" Pipe Joint Compound	20
Ratchet, with Step Release J-Hooks	24	"Green Blaster" Drain Opener	20
Strap Wrench	4	Seal Unyte	20
Striking Tools	11	"Select Unyte" Teflon Pipe Joint Compound	20
Sure Sweat Dissolvable Pipe Plugs	16	Wire Brush	26
Swivel-Lite	27	Wire Connectors, Screw-On	29
4 D/6 Volt	27	Wood Bits	13
Industrial Flashlights	27	Dual Auger	13
T		Flat "Paddle"	14
Tamping/Digging Bar	11	Wood Folding Ruler With Extension	15
Tape, Caution	25	Wool, Steel	26
Tape Measure	14	Work Gloves	22
Chrome Precision	14	Wrench	

4-Way Countersunk Plug.....	2
4-Way Plug.....	2
4-Way P.O. Plug	1
6-Way Countersunk Plug.....	2
Adjustable	4
Adjustable Strainer And Spud.....	3
Aluminum Pipe.....	4
Angle Compression Stop	2
Box	4
Curb Box	4
Do All Plumbers.....	4
Dual Kwik Tie.....	2
Element	1
Faucet Seat	2
Garbage Disposal.....	1
Heavy Duty Pipe.....	4
Mega Torque.....	1
Moen Stem And Cartridge.....	3
No Hub Torque	1
Plumb Easy Sink Strainer.....	4
Quick Drain.....	3
Radiator Spud	1
Seat, for Recessed Seats	2
Set.....	1
14 Piece Folding Hex Key Wrench.....	1
Tub And Shower Valve Wrench.....	1
Sink Drain	3
Spanner/Strainer	3
Spud	3
Spud With Hinged Arm	3
Strainer.....	3
Strap	4
Universal Drain.....	2
Wypall	28
Teri Towels.....	28
Waterless Hand Wipes.....	28
Y	
Yarning or Packing Tools	10

PART NO.	PG #
B05001	28
B05002	28
B05003	28
B05004	28
B05007	28
B05008	28
B05010	23
B05011	23
B05015	23
B05020	23
B05021	23
B10004	5
B11010	1
B11011	1
B11012	1
B11013	1
B20062	14
B20078	14
B20094	14
B20109	14
B20125	14
B20141	14
B20156	14
B20172	14
B20188	14
B20203	14
B20219	14
B20234	14
B20250	14
B20266	14
B20281	14
B20297	14
B20313	14
B20328	14
B20344	14
B20359	14

PART NO.	PG #
B20375	14
B20391	14
B20406	14
B20422	14
B20438	14
B20453	14
B20469	14
B20484	14
B20500	14
B21075	13
B21087	13
B21100	13
B21112	13
B21125	13
B21150	13
B21625	13
B22050	13
B22075	13
B22087	13
B22100	13
B22112	13
B22125	13
B22150	13
B22625	13
B24050	14
B24056	14
B24063	14
B24075	14
B24081	14
B24088	14
B24100	14
B24113	14
B24125	14
B24150	14
B24375	14
B25001	28

PART NO.	PG #
B28025	5
B28050	5
B28051	5
B28075	5
B28076	5
B28100	5
B28125	5
B28150	5
B28200	5
B28375	5
B29025	5
B29050	5
B29051	5
B29075	5
B29076	5
B29100	5
B29125	5
B29150	5
B29200	5
B29300	26
B29310	26
B29375	5
B29400	26
B29625	5
B29699	26
B29700	26
B29701	26
B29702	26
B29801	26
B29802	26
B29875	5
B29900	26
B29999	5
C35090	18
C35091	18
D50000	28

PART NO.	PG #
E25015	29
E25016	29
E25017	29
E25018	29
E25115	29
E25116	29
E25117	29
E25118	29
E25125	29
E25126	29
E25127	29
E25128	29
E25129	29
E85000	23
F20001	27
F20002	27
F20003	27
F20004	27
F20005	27
F20006	27
F20007	27
F20008	27
F20009	27
F20010	27
F20011	27
F20012	27
F20013	27
F20014	27
F20015	27
F20016	27
F20017	27
F20018	27
F20019	27
G02033	28
G02042	28
G04000	25

PART NO.	PG #
G04001	25
G04002	25
G30000	22
G30001	22
G30003	22
G30004	22
G30005	22
G30008	23
G30011	22
G30012	22
G30013	22
G30014	22
G30015	22
G30016	22
G30017	22
G30021	23
G30030	22
G50200	22
G50202	22
G50204	22
G50205	22
G50206	22
G50208	22
G50210	22
G50214	22
G50218	22
G50250	22
G50251	22
G90001	28
G90002	28
H40001	23
H40002	23
H40003	23
H40004	23
H54050	19
H54100	19

PART NO.	PG #
H56050	16
H56075	16
J36100	1
J36101	1
J40000	1
J40001	1
J40002	1
J40003	1
J40004	1
J40005	1
J40006	1
J40007	2
J40008	1
J40010	3
J40011	3
J40012	3
J40013	3
J40015	1
J40018	2
J40019	4
J40020	25
J40021	3
J40022	3
J40023	3
J40024	3
J40025	1
J40026	1
J40028	3
J40030	1
J40035	2
J40040	2
J40041	2
J40042	2
J40044	15
J40045	15
J40046	15

PART NO.	PG #
J40047	15
J40048	15
J40049	15
J40050	13
J40051	13
J40052	13
J40053	13
J40054	13
J40055	13
J40056	9
J40057	9
J40060	25
J40061	25
J40062	25
J40063	25
J40065	4
J40066	4
J40067	4
J40068	4
J40069	4
J40070	4
J40071	4
J40072	4
J40073	4
J40074	4
J40075	4
J40076	4
J40077	4
J40078	4
J40079	4
J40080	12
J40085	14
J40086	14
J40087	14
J40088	14
J40089	14

PART NO.	PG #
J40090	25
J40092	25
J40093	15
J40094	9
J40095	9
J40096	9
J40097	9
J40098	9
J40099	9
J40100	26
J40101	14
J40103	26
J40105	4
J40106	4
J40107	24
J40108	24
J40111	24
J40115	24
J40123	5
J40128	4
J40134	24
J40140	11
J40141	11
J40142	11
J40143	11
J40144	11
J40145	11
J40156	9
J40157	9
J40158	9
J40197	18
J40198	5
J40199	18
J40200	18
J40201	18
J40202	18

PART NO.	PG #
J40203	18
J40204	18
J40206	18
J40207	18
J40208	18
J40210	16
J40211	16
J40212	16
J40213	7
J40214	7
J40215	7
J40217	7
J40218	7
J40219	7
J40220	12
J40221	13
J40222	13
J40223	5
J40224	5
J40225	5
J40228	7
J40229	15
J40230	4
J40235	3
J40240	7
J40241	7
J40242	7
J40243	7
J40244	7
J40250	12
J40251	12
J40260	7
J40261	7
J40262	7
J40263	7
J40284	18
J40285	18

PART NO.	PG #
J40286	18
J40287	19
J40288	18
J40289	18
J40305	3
J40306	3
J40307	4
J40308	4
J40311	4
J40325	4
J40329	15
J40330	19
J40331	19
J40332	19
J40333	19
J40334	19
J40335	19
J40336	19
J40337	19
J40338	19
J40339	19
J40340	19
J40341	19
J40342	19
J40343	19
J40350	19
J40351	19
J40352	19
J40353	19
J40360	19
J40361	19
J40369	12
J40375	12
J40380	19
J40381	19
J40382	19
J40383	19

PART NO.	PG #
J40384	19
J40385	19
J40386	19
J40387	19
J40393	23
J40401	17
J40402	17
J40403	17
J40404	17
J40405	17
J40406	17
J40407	17
J40408	17
J40410	16
J40411	16
J40412	17
J40414	17
J40420	16
J40421	16
J40422	16
J40429	15
J40450	25
J40451	25
J40481	25
J40482	25
J40490	2
J40491	2
J40529	15
J40600	15
J40601	15
J40629	15
J40750	12
J40775	12
J40800	12
J40801	16
J40802	16
J40803	16

PART NO.	PG #
J40804	16
J40805	16
J40806	16
J40807	16
J40808	16
J40812	15
J40830	6
J40831	6
J40900	8
J40901	8
J40902	8
J40903	8
J40920	8
J40921	8
J40922	8
J40923	8
J40924	8
J40925	8
J40926	8
J40930	8
J40935	8
J40936	8
J40937	8
J40938	8
J40950	12
J40951	12
J40952	12
J40953	12
J40954	12
J40955	12
J40960	12
J40965	12
J40966	12
J41002	10
J41006	10
J41008	10

PART NO.	PG #
J41009	10
J41010	10
J41011	11
J41021	15
J41022	15
J41023	15
J41024	15
J41030	25
J41031	25
J41032	25
J41100	13
J41101	13
J41102	13
J41103	13
J41104	13
J41105	13
J41106	13
J41107	13
J41108	13
J41201	16
J41202	16
J41203	16
J41204	16
J41205	16
J41206	16
J42002	12
J42003	12
J42004	12
J42008	25
J42012	25
J42100	26
J42101	26
J42200	27
J43300	25
J43310	25
J44050	6

PART NO.	PG #
J44075	6
J44100	6
J44150	6
J44200	6
J44300	6
J44400	6
J44661	3
J45005	27
J45010	2
J45015	3
J45100	21
J46118	26
K01120	23
K012000	23
K50001	9
K50002	9
K50003	9
K50005	9
K50015	19
K50016	19
K50041	9
K50042	9
L42011	26
L42012	26
L42013	26
L42014	26
L42015	26
L42016	26
L42017	26
L42018	26
L42019	26
L42023	26
L95400	29
M25100	12
M25127	12
M25130	12

PART NO.	PG #
M25136	12
M25148	12
M25527	12
M25536	12
M25560	12
M25736	12
M25760	12
M25772	12
M25784	12
M25900	4
N70016	21
N70020	21
N70024	21
N70032	21
N70050	21
N70075	21
N70150	21
N70175	21
N70200	21
N70250	21
N70300	21
N70500	21
N70575	21
P10001	5
P10002	5
P13600	5
P27001	11
P27003	11
P27004	11
P27005	11
P27040	11
P27048	11
P40004	20
P40014	20
P40080	20
P60001	16

PART NO.	PG #
P60002	16
P60003	16
P70001	6
P70002	6
P70005	6
P70006	6
P70010	6
P70011	6
P70012	6
P70015	6
P70016	6
P70018	6
P70019	6
P70020	6
P70023	6
P70029	6
P70030	6
P70031	6
P70035	6
P70036	6
P70050	6,7
P70051	7
P70052	7
P70053	7
P70055	6
P70056	67
P70060	7
P70064	7
P70065	7
P70066	7
P70067	7
P70069	7
S06014	18
S06015	18
S06016	18
S06017	18

PART NO.	PG #
S06018	18
S06019	18
S06020	17
S08100	28
S10100	28
S12100	28
S20015	24
S20021	24
S20031	24
S20041	24
S20100	24
S20101	24
S20102	24
S20103	24
S20104	24
S20105	24
S20106	24
S20200	24
S20201	24
S20202	24
S20203	24
S20204	24
S20300	24
S20301	24
S20302	24
S20999	24
S41001	17
S41002	17
S41003	17
S41006	17
S41007	17
S41010	17
S41012	17
S41300	17
S41301	17
S41302	17
S41303	17
S41306	18

PART NO.	PG #
S41307	18
S41308	18
S41349	13
S41350	13
S41351	13
S41352	13
S41353	13
S41354	13
S41355	13
S41356	13
S41357	13
S41358	13
S41359	13
S41360	13
S41361	13
S41362	13
S41363	13
S49000	8
S49001	8
S49002	8
S49003	9
S49004	8
S49005	8
S49006	8
S49007	8
S49008	8
S49010	8
S49012	8
S49013	8
S49036	8
S49048	8
S49136	8
S49148	8
S49200	8
S49201	8
S49236	9
S49400	10
S49411	10

PART NO.	PG #
S49412	10
S49413	10
S49416	10
S49417	10
S49421	10
S49422	10
S49423	10
S49425	10
S49427	10
S49429	10
S49431	10
S49432	10
S49489	11
S49490	11
S49500	11
S49501	11
S49601	23
S49602	23
S49603	23
S50001	28
S50002	28
S50060	9
S50061	9
S50062	9
S50063	9
S62001	2
S62002	2
S62003	2
S62004	2
S62005	2
S95011	20
S95012	20
S95014	20
S95015	21
S95016	20
S95100	20
S95101	20
S95102	15

PART NO.	PG #
S95103	15
S95104	15
S95105	15
S95200	20
S95700	25
S95701	20
S95703	20
S95704	20
S95705	20
S95709	20
S95710	20
S95711	20
S95712	20
S95713	20
S95714	20
S95715	20
S95721	20
S95722	20
S95725	20
S96012	20
S96014	20
S96016	20
T41001	14
T41002	14
T41003	14
T41004	14
T41005	14
T41006	14
T41007	14
T41008	14
T41009	14
T50001	24
T60060	1
T60065	1
T60066	1
T60080	1
T60081	1

PART NO.	PG #
T60100	21
T60101	21
T60102	21
T60103	21
T60104	21
T60105	21
T60106	21
T60107	21
T60108	21
T60110	21
T60111	21
T60121	21
T60122	21
T60123	21
T60124	21
T60125	21
T60126	21
T60127	21



GASKETS & COUPLINGS

VOLUME V



Quality
Products *for*
the Plumbing
Professional

Gaskets 2

Couplings 3

Import Couplings..... 4

Multi-Tite Gaskets



SERVICE WEIGHT



EXTRA HEAVY

- Multi rings on outside make this gasket the easiest to install
- Meets ASTM Standard C564
- CARTON QUANTITIES ONLY

Service Weight

PART NO.	SIZE	CTN QTY
V95002	2"	150
V95003	3"	75
V95004	4"	60
V95005	5"	30
V95006	6"	30
V95008	8"	20
V95010	10"	10
V95012	12"	10
V95015	15"	5

Extra Heavy

PART NO.	SIZE	CTN QTY
V94004	4"	60

Dual Tite Gaskets



SERVICE WEIGHT



EXTRA HEAVY

- Meets ASTM Standard C564
- CARTON QUANTITIES ONLY

Service Weight

PART NO.	SIZE	CTN QTY
V96002	2"	150
V96003	3"	75
V96004	4"	60
V96005	5"	30
V96006	6"	30
V96008	8"	20
V96010	10"	10
V96012	12"	10
V96015	15"	5

Extra Heavy

PART NO.	SIZE	CTN QTY
V97002	2"	150
V97003	3"	75
V97004	4"	60
V97005	5"	30
V97006	6"	30
V97008	8"	20
V97010	10"	10
V97012	12"	10
V97015	15"	5

Dual Tite Buna N "Nitrile" Gasket



PART NO.	SIZE	CTN QTY
V98002	2"	150
V98003	3"	75
V98004	4"	60
V98005	5"	30
V98006	6"	30
V98008	8"	20
V98010	10"	10
V98012	12"	10
V98015	15"	5

Pipe Lubricant



- Carton Quantities Only
- L95202 - ORM-D. Ships UPS Ground and Motor Freight ONLY

PART NO.	DESCRIPTION	CTN QTY
L95200	Quart lubricant	6
L95201	Gallon lubricant	4
L95202	Quart adhesive lube	4

No Hub Couplings



- Made in the U.S.A.
- Manufactured in accordance with CISPI Standard 310
- Gasket sleeve conforms to ASTM C564
- Screw is ASI 305 stainless steel



PART NO.	SIZE	CTN QTY	CTN / PALLET
U95001	1-1/2"	100	24
U95002	2"	100	24
U95003	3"	100	12
U95004	4"	100	12
U95005	5"	20	24
U95006	6"	25	18
U95008	8"	15	16
U95010	10"	12	16
U95012	12"	6	6
U95015	15"	6	6

PART NO.	SIZE	CTN QTY	CTN / PALLET
U95211	2" x 1-1/2"	100	24
U95320	3" x 2"	60	12
U95430	4" x 3"	60	8

No Hub Torque Wrench



- Automatic release at 60 in.lb.
- Ratchets one way
- Built-in reversing lever
- Chrome vanadium socket

PART NO.	DESCRIPTION	CTN QTY
T60060	No hub torque wrench	10

Mega Torque Wrench



- Heavy duty construction with chrome vanadium 5/16" or 3/8" sockets
- Socket kit includes screw and washer
- Slide down locking reversing feature

PART NO.	DESCRIPTION	CTN QTY
T60065	60 lb. - 5/16"	1
T60080	80lb. - 3/8"	1
T60081	80lb. - 5/16"	1
T60066	5/16" socket kit	1

Medium Duty No Hub Coupling



- 9/16" stainless steel bands
- Stainless steel housing and shield
- 5/16" stainless steel screws
- 80 inch/lb. installation torque

PART NO.	DESCRIPTION	CTN QTY
U97001	1-1/2"	60
U97002	2"	75
U97003	3"	48
U97004	4"	48
U97005	5"	15
U97006	6"	15
U97008	8"	15
U97010	10"	12

Heavy Duty No Hub Couplings



- 9/16" stainless steel bands
- Stainless steel housing and shield
- 3/8" stainless steel screws • 3/8" stainless steel screws
- 80 inch/lb. installation torque

PART NO.	DESCRIPTION	CTN QTY
HDNHC1	1-1/2"	100
HDNHC2	2"	100
HDNHC3	3"	80
HDNHC4	4"	100
HDNHC5	5"	20
HDNHC6	6"	20
HDNHC8	8"	10
HDNHC10	10"	10

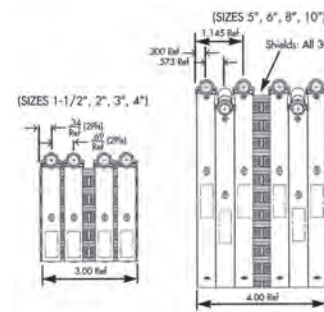

DESCRIPTION: Couplings consist of gasket and shield assemblies. The shield assemblies have four or six clamps depending on size. The clamps are fastened with eyelets to the bi-directional corrugated shield.

MATERIALS: Steels used in couplings are stainless steels. Shields, bands and housings are AISI 304. Screws and eyelets are AISI 305. Gaskets are neoprene rubber.

SPECIFICATIONS: Couplings conform to CISPI 310. Factory Mutual EN 1618. Couplings comply with ASTM C564, ASTM 1277, IAPMO file #3198, Commonwealth of Massachusetts CMR-248 and City of New York MEA 253-98-E. Gaskets are made from an elastomeric compound that meets the requirements of ASTM C564.

JSC PART #	COUPLING SIZE	INSTALLATION TORQUE	CLAMPS FOR COUPLING
HDN-HC1	1-1/2"	80	4
HDN-HC2	2"	80	4
HDN-HC3	3"	80	4
HDN-HC4	4"	80	4
HDN-HC5	5"	80	6
HDN-HC6	6"	80	6
HDN-HC8	8"	80	6
HDN-HC10	10"	80	6

Larger Hex Head Screw:
The new 3/8" hex head screw is designed to apply the full load of 80in/lbs. of insulation torque to the band/shield assembly.

Patented Bi-directional Shield Design: Our unique shield design employs bi-directional corrugations for maximum transfer of pressure from the clamps the gasket. This patented shield design adjusts to differences in the circumference and outside diameters for the pipes being joined. This eliminates gasket wrinkling and thereby eliminates leak paths. These parallel and transverse patterns on the gasket and pipe work to avoid pullout failures and provides a positive, reliable seal.

Specially Beaded Gaskets:
The heavy-duty coupling utilizes a specially beaded gasket that mates with the shield and clamping forces for superior sealing pressure and holding power. IDEAL gaskets comply with ASTM C564.

Floating Eyelet Design:
"Floating eyelets" fasten the clamps to the shield, allowing the clamp band and shield to move independently. This freedom prevents the shield from crimping during tightening, which can lead to leakage later on.

Mechanical Interlocking Clamp Design: IDEAL clamps feature a one-piece screw housing that mechanically interlocks the housing to the band. This one-piece housing design eliminates leak paths that can occur in stacked or welded clamps.

Green Shield:
The distinctive green shield quickly identifies the newly re-engineered IDEAL Heavy-Duty Couplings.

Import No Hub Coupling



- All stainless construction
- UPC approved
- Made in South Korea
- CARTON QUANTITIES ONLY

PART NO.	DESCRIPTION	CTN QTY
U99001	1-1/2"	200
U99002	2"	200
U99003	3"	150
U99004	4"	100
U99005	5"	60
U99006	6"	30
U99008	8"	15
U99010	10"	12
U99110	10"	10
U99211	2" x 1-1/2"	200
U99320	3" x 2"	100

Import Heavy Duty No Hub Coupling



- 9/16" stainless steel bands
- Stainless steel housing and shield
- 3/8" stainless steel screws • 3/8" stainless steel screws
- 80 inch/lb. installation torque
- Made in South Korea

PART NO.	DESCRIPTION	CTN QTY
U99220	2"	75
U99330	3"	48
U99440	4"	48
U99550	5"	15
U99660	6"	15
U99880	8"	15



SECTION M - MERCHANDISING

VOLUME V



Quality
Products *for*
the Plumbing
Professional

Pegboard Merchandising..... 1-5

Tilt Bin Merchandising 6-16

Gondola Merchandising 17-19

Drain Merchandising..... 20-21

Chemical Merchandising 22-24

Product Index..... 25

Part Number Index..... 26

PlumBest Tool Center

Display Part No. TB1100

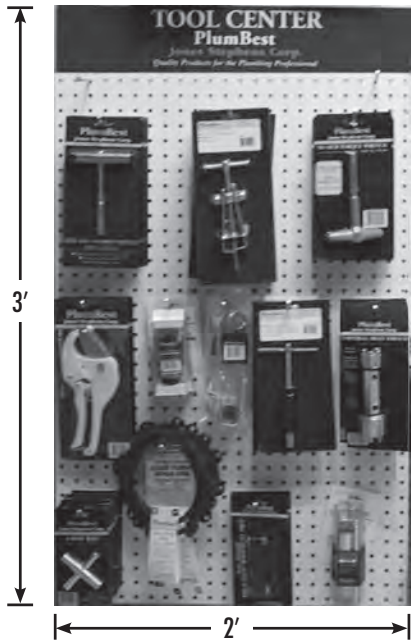

• 2' x 3' pegboard

PART NO.	DESCRIPTION	QTY
J45010	Universal Drain Wrench	5
J45015	Moen Cartridge Wrench	5
T60060	No Hub Torque Wrench	5
J40010	Faucet Handle Puller	5
J40015	Hex Key Set	5
J40048	Flint Striker	5
P70018	Professional PVC Cutter	5
J40021	Compression Sleeve Puller	3
J40005	4-Way Key	10
J40028	Strainer Wrench	5
C85000	Closet Flange Repair Ring	5
J40018	Extract-A-Drain	4

PlumBest Cutting Board

Display Part No. TB1200

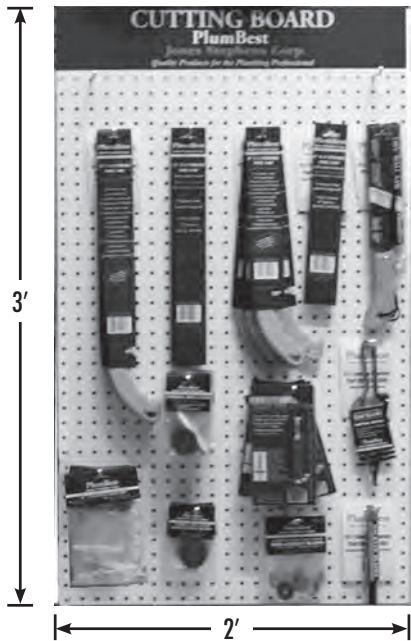

• 2' x 3' pegboard

PART NO.	DESCRIPTION	QTY
P70023	Inside Pipe Cutter	6
P70029	P70023 Replacement Blades	3
J40830	E-Z Shear Inside Pipe Cutter	6
J40831	J40830 Replacement Blades	3
S49008	12" E-Z Stroke Pipe Saw	6
S49007	12" E-Z Stroke Replacement Blade	6
S49236	T-Handle Cable Saw	6
S50060	Close Quarters Hacksaw	5
S49005	8" E-Z Stroke Pipe Saw	5
S49006	S49005 Replacement Blades	5
S50061	Close Quarters Hacksaw Blades	20
S49012	PlumBest Drywall Saw	6

PlumBest Socket Saver

Display Part No. TB1300

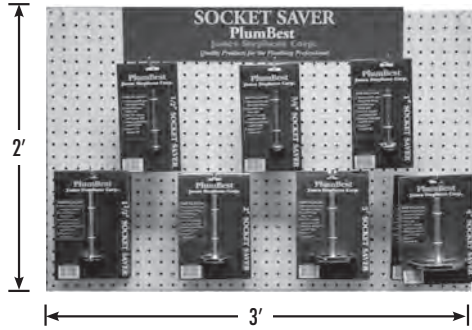

• 3' x 2' pegboard

PART NO.	DESCRIPTION	QTY
J44050	1/2" Socket Saver	4
J44075	3/4" Socket Saver	4
J44100	1" Socket Saver	4
J44150	1 1/2" Socket Saver	4
J44200	2" Socket Saver	4
J44300	3" Socket Saver	2
J44400	4" Socket Saver	2

PlumBest Tool Board

Display Part No. RTB100

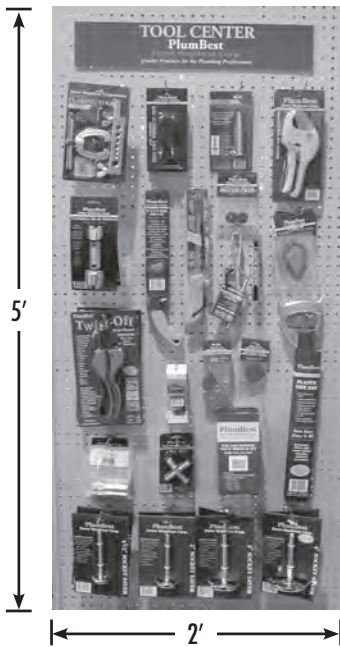

PART NO.	DESCRIPTION	QTY
J40002	Tub/Shower Valve Wrench Set	2
J40005	4-Way Key	2
J40015	Hex Key Set	2
J40018	Extract-A-Drain Tub Extraction Tool	2
J40054	Nipple Extractor Set	2
J40080	Flaring Tool	2
J40325	Twist-Off Strap Tool	2
J40830	E-Z Shear Inside Pipe Cutter	2
J40831	E-Z Shear Pipe Cutter Blades	2
J44150	1 1/2" Socket Saver	2
J44200	2" Socket Saver	2
J44300	3" Socket Saver	2
J44400	4" Socket Saver	2
J45010	Universal Drain Wrench	2
P70018	Professional PVC Pipe Cutter	2
P70023	Inside Pipe Cutter	2
P70029	Inside Pipe Cutter Blades	2
P70066	1/8" x 1 1/8" Tube Cutter	2
S49001	PlumBest Plastic Pipe Saw	2
S49005	8" E-Z Stroke Pipe Saw	2
S49012	PlumBest Drywall Saw	2
S49036	36" PVC Cable Saw	2
S50060	Close Quarters Hacksaw	2
S50061	Close Quarters Hacksaw Blades	2
T50001	3-N-1 Tubing Bender	2

PlumBest Tool Board

Display Part No. TB1600

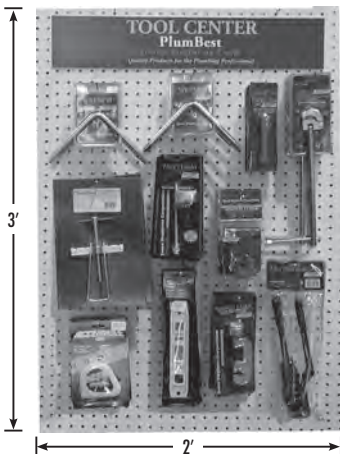

• 2' x 3' pegboard

PART NO.	DESCRIPTION	QTY
S62004	Angle Stepped Faucet Seat Wrench	6
S62002	Angle Tapered Faucet Seat Wrench	6
J40007	Faucet Seat Repair Kit	4
T50001	3-N-1 Tubing Bender	3
P70052	Mini Tube Cutter	6
P70066	Economy Tube Cutter	5
B11011	Telescoping Basin Wrench	6
J40012	E-Zee Pull Deluxe Faucet Handle Puller	6
J40051	Internal Pipe Nipple Extractors	6
J40101	Accu-Rule Tape Measure	4
J40100	Torpedo Level	6

Complete Tool Center

Display Part No. TB1700

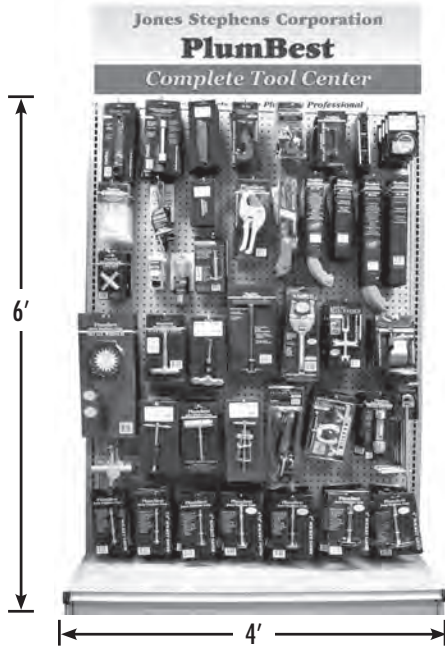

• 4' x 6' pegboard

PART NO.	DESCRIPTION	QTY
J45010	Universal Drain Wrench	5
J45015	Moen Cartridge Wrench	5
T60060	No Hub Torque Wrench	5
J40010	Faucet Handle Puller	5
J40015	Hex Key Set	5
J40048	Flint Striker	5
P70018	Professional PVC Cutter	5
J40021	Compression Sleeve Puller	3
J40042	6-Way Countersunk Plug Wrench	4
J40005	4-Way Key	10
S50060	6" Close Quarters Hacksaw	10
S50061	Close Quarters Hacksaw Blades	50
C85000	Closet Flange Repair Ring	5
P70023	Inside Pipe Cutter	6
P70029	Inside Pipe Cutter Blades	3
J40830	E-Z Shear Inside Pipe Cutter	6
J40831	E-Z Shear Inside Pipe Cutter Blade	3
S49008	12" E-Z Stroke Pipe Saw	6
S49007	12" E-Z Stroke Pipe Saw Blade	6
S49005	8" E-Z Stroke Pipe Saw	5
S49006	8" E-Z Stroke Pipe Saw Blade	5
S49012	PlumBest Drywall Saw	6
S49236	T-Handle Cable Saw	6
J40028	Strainer Wrench	5
J40018	Extract-A-Drain	5
J40019	Do All Plumbers Wrench	3
J44050	1/2" Socket Saver	4
J44075	3/4" Socket Saver	4
J44100	1" Socket Saver	4
J44150	1 1/2" Socket Saver	4
J44200	2" Socket Saver	4
J44300	3" Socket Saver	2
J44400	4" Socket Saver	2



Utility Tie-Down Strap

Display Part No. S20001

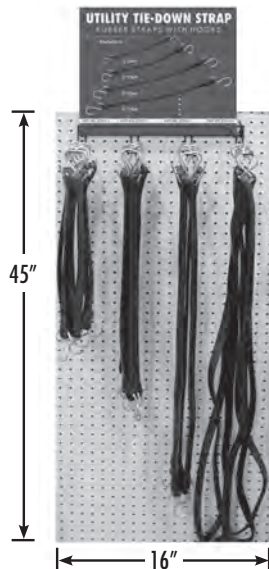

- Extra Heavy Duty
- American Trucker certified
- Weather and ozone resistant
- Made in the USA

MADE IN THE
USA

PART NO.	LENGTH	MAX STRETCH	QTY
S20015	15"	20"	25
S20021	21"	36"	25
S20031	31"	53"	25
S20041	41"	70"	25

Cam Straps

Display Part No. S20999

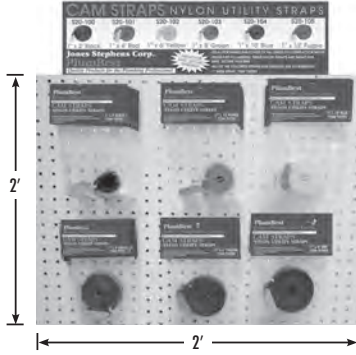

• 2' x 2' pegboard

PART NO.	DESCRIPTION	QTY
S20100	1" x 2' Black	12
S20101	1" x 4' Red	12
S20102	1" x 6' Yellow	12
S20103	1" x 8' Green	12
S20104	1" x 10' Blue	12
S20105	1" x 12' Purple	12

Work Gloves

• Display Rack and Display Box included



Display Rack

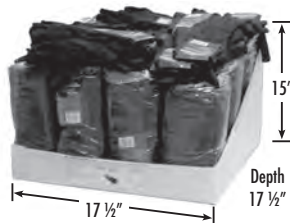

Display Box

Display Part No. G50210

PART NO.	DESCRIPTION	QTY
G50200	Brown Cotton Jersey	216 pair

Display Part No. G50214

PART NO.	DESCRIPTION	QTY
G50204	Leather Palm Low Safety Cuff	96 pair

Display Part No. G50218

PART NO.	DESCRIPTION	QTY
G50208	Drivers' Style Leather	48 pair

Stainless Steel Connectors Extended Assortment

Display Part No. SSC100

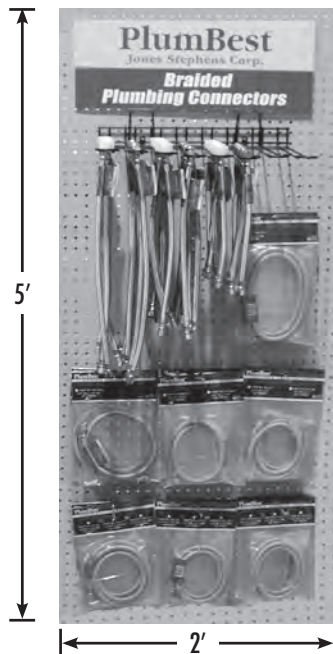

PART NO.	DESCRIPTION	QTY
S04201	3/8" OD x 1/2" FIP x 12" SS Faucet Con.	25
S04202	3/8" OD x 1/2" FIP x 16" SS Faucet Con.	12
S04203	3/8" OD x 1/2" FIP x 20" SS Faucet Con.	25
S04204	3/8" OD x 1/2" FIP x 30" SS Faucet Con.	5
S04217	3/8" OD x 7/8" BC x 12" SS Ballcock Con.	25
S04218	3/8" OD x 7/8" BC x 16" SS Ballcock Con.	12
S04219	3/8" OD x 7/8" BC x 20" SS Ballcock Con.	12
S04227	3/4" FH x 3/4" x 48" SS Washing Machine Con.	5
S04228	3/4" FH x 3/4" x 60" SS Washing Machine Con.	5
S04234	3/8" OD x 3/8" MIP x 60" SS Dishwasher Con.	5
S04237	1/2" OD x 3/8" MIP x 60" SS Dishwasher Con.	5
S04238	1/2" OD x 3/8" MIP x 72" SS Dishwasher Con.	5
S04232	1/2" OD x 1/4" OD x 84" SS Icemaker Con.	5
H99000	Flexible Connector Display Unit w/Header	1
TB1Hook	Additional Hooks	6

Stainless Steel Connectors Assortment

Display Part No. S04303

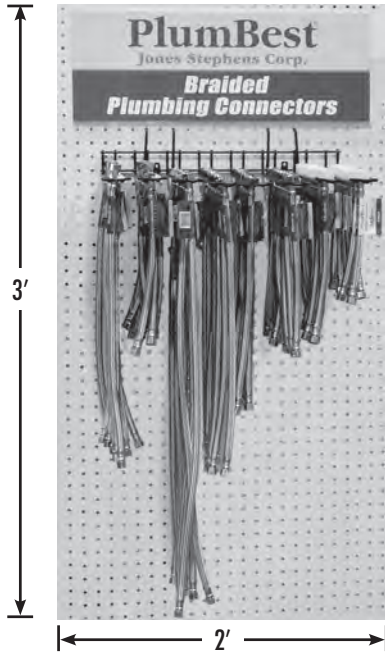

• CARTON QUANTITIES ONLY

PART NO.	DESCRIPTION	QTY
S04201	3/8" OD x 1/2" FIP x 12" SS Faucet Con.	8
S04202	3/8" OD x 1/2" FIP x 16" SS Faucet Con.	8
S04203	3/8" OD x 1/2" FIP x 20" SS Faucet Con.	8
S04204	3/8" OD x 1/2" FIP x 30" SS Faucet Con.	8
S04216	3/8" OD x 7/8" BC x 9" SS Ballcock Con.	7
S04217	3/8" OD x 7/8" BC x 12" SS Ballcock Con.	7
S04240	3/8" OD x 12" SS Delta Style Faucet Con.	12
S04242	3/8" OD x 20" SS Delta Style Faucet Con.	12
H99000	Flexible Connector Display Unit w/Header	1
TB1000	2' x 3' Peg Board	1

Braided Plumbing Connectors Assortment

Display Part No. BNC100

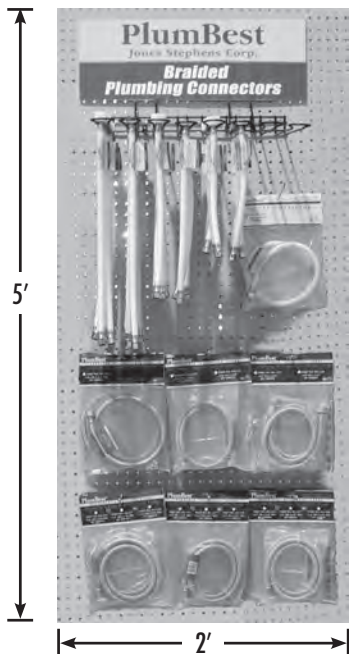

PART NO.	DESCRIPTION	QTY
S04401	3/8" OD x 1/2" FIP x 12" BN Faucet Con.	25
S04402	3/8" OD x 1/2" FIP x 16" BN Faucet Con.	12
S04403	3/8" OD x 1/2" FIP x 20" BN Faucet Con.	25
S04404	3/8" OD x 1/2" FIP x 30" BN Faucet Con.	5
S04415	3/8" OD x 7/8" BC x 12" BN Ballcock Con.	25
S04416	3/8" OD x 7/8" BC x 16" BN Ballcock Con.	12
S04417	3/8" OD x 7/8" BC x 20" BN Ballcock Con.	12
S04227	3/4" FH x 3/4" x 48" SS Washing Machine Con.	5
S04228	3/4" FH x 3/4" x 60" SS Washing Machine Con.	5
S04234	3/8" OD x 3/8" MIP x 60" SS Dishwasher Con.	5
S04237	1/2" OD x 3/8" MIP x 60" SS Dishwasher Con.	5
S04238	1/2" OD x 3/8" MIP x 72" SS Dishwasher Con.	5
S04232	1/4" OD x 1/4" OD x 84" SS Icemaker Con.	5
H99000	Braided Nylon Connectors Display w/Header	1
TB1Hook	Additional Hooks	6

Complete Brass Assortment

Display Part No. Q01011

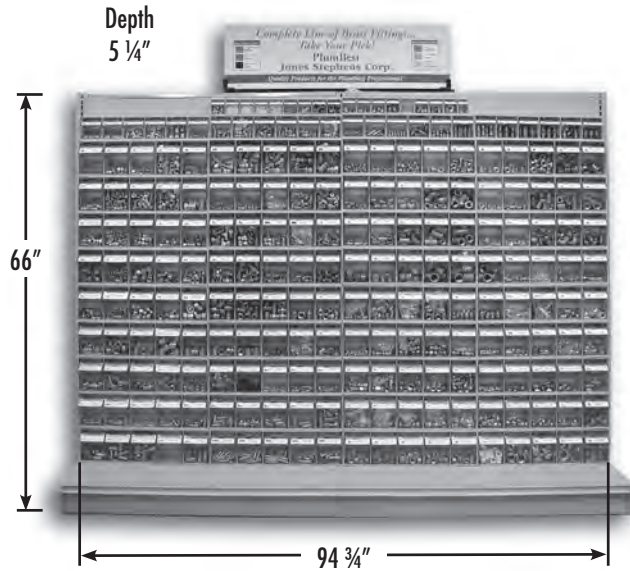

*Gondola Not Included

- Complete Brass assortment includes all 5 of the assortments (Q01012, Q01013, Q01014, Q01015, Q01016) plus the following items:
- Get 42 Multistore Bins FREE!
- Note: The items listed on this page are currently included in our complete brass assortment, but not as part of the individual assortment packages.

PART NO.	DESCRIPTION	QTY
N10442	1/4" OD x 1/8" MIP (Angle Needle Valve)	25
N15100	3/8" x Close CP Nipple	5
N15200	3/8" x 2" CP Nipple	5
N15400	3/8" x 4" CP Nipple	5
N16100	1/2" x Close CP Nipple	5
N16200	1/2" x 2" CP Nipple	5
N16400	1/2" x 4" CP Nipple	5
B50001	3/8" 90° CP Elbow	5
B50002	1/2" 90° CP Elbow	5
B50041	3/8" CP Coupling	5
B50042	1/2" CP Coupling	5
B50031	3/8" CP Tee	5
B50032	1/2" CP Tee	5
B10100	1/2" - 14 x 3/8" Regular Zamak Basin Nut	25
B10101	1/2" - 14 x 3/8" Tapered Zamak Basin Nut	25
B10102	1/2" - 14 x 1/2" Regular Zamak Basin Nut	25
B10103	1/2" - 14 x 9/16" Regular Zamak Basin Nut	25
B10104	1/2" - 14 x 9/16" Regular Brass Basin Nut	25
B10105	1/2" - 14 x 1/2" White Faucet Nut	25
C74002	3/8" Compression Cap	25
C74011	7/8" OD Compression Sleeve	50
C74020	7/8" OD Compression Nut	50
C74093	5/8" OD x 5/8" OD (1/2" Sweat Adapter)	25
C74094	3/8" CP Compression Nut	25
C74096	1/4" OD Delrin Comp Sleeve	100
C74097	3/8" OD Delrin Comp Sleeve	100
C74098	1/2" OD Delrin Comp Sleeve	100
C74099	5/8" OD Delrin Comp Sleeve	25
C74100	1/4" Brass Insert	100
C74101	3/8" Brass Insert	100
C74102	1/2" Brass Insert	40
C74103	5/8" Brass Insert	25
S92001	Self-piercing Needle Valve Kit	10
T77125	1 1/4" x 1 1/4" CP Slip Joint Nut	25
T77150	1 1/2" x 1 1/2" CP Slip Joint Nut	25
T77151	1 1/2" x 1 1/4" CP Slip Joint Nut	25
C05080	5/8" x 1/2" Zinc Ballcock Coupling Nut	25
C05081	5/8" x 7/8" Brass Ballcock Coupling Nut	25
G20056	3/4" FGH Cap with Chain	10
A11001	1/4" FIP x 1/4" MIP Brass Air Cock with Lever Handle and Hex Shoulder	5
A11003	1/4" FIP x 1/4" MIP Brass Air Cock with Tee Handle and Hex Shoulder	5
A11004	1/4" FIP x 1/4" FIP Brass Air Cock with Lever Handle and Round Shoulder	5
A11005	1/4" FIP x 1/4" FIP Brass Air Cock	5
N01001	1/8" MIP Lever Handle Drain Cock	10
N01002	1/4" MIP Lever Handle Drain Cock	10
Q01005	5-unit Tilt Bin Display	36
Q01006	6-unit Tilt Bin Display	4
Q01009	9-unit Tilt Bin Display	2

Flare Fittings Assortment

Display Part No. Q01013

• Get 5 Multistore Bins FREE!

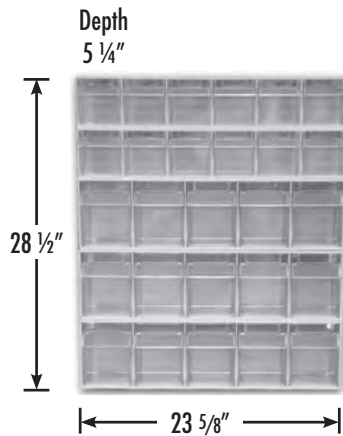

PART NO.	DESCRIPTION	QTY
F40002	1/4" Short Flare Nut	25
F40004	3/8" Short Flare Nut	50
F40005	1/2" Short Flare Nut	50
F40006	5/8" Short Flare Nut	25
F40020	3/8" Flare Cap	25
F40021	1/2" Flare Cap	25
F40023	1/4" Flare Union	25
F40025	3/8" Flare Union	25
F40026	1/2" Flare Union	25
F40027	5/8" Flare Union	10
F40035	3/8" Flare Tee	10
F40036	1/2" Flare Tee	10
F40048	3/8" Flare x 3/8" FIP Coupling	20
F40049	3/8" Flare x 1/2" FIP Coupling	20
F40052	1/2" Flare x 3/8" FIP Coupling	20
F40053	1/2" Flare x 1/2" FIP Coupling	20
F40055	5/8" Flare x 1/2" FIP Coupling	15
F40063	1/4" Flare x 1/8" MIP Half Union	20
F40064	1/4" Flare x 1/4" MIP Half Union	20
F40068	3/8" Flare x 1/4" MIP Half Union	20
F40069	3/8" Flare x 3/8" MIP Half Union	25
F40070	3/8" Flare x 1/2" MIP Half Union	25
F40073	1/2" Flare x 3/8" MIP Half Union	25
F40074	1/2" Flare x 1/2" MIP Half Union	25
F40076	5/8" Flare x 1/2" MIP Half Union	15
F40088	3/8" Flare x 3/8" MIP Elbow	10
Q01005	5-unit Tilt Bin Display	3
Q01006	6-unit Tilt Bin Display	2

Brass Flare Tube Fittings Assortment

Display Part No. Q01013R

• Get 5 Multistore Bins FREE!

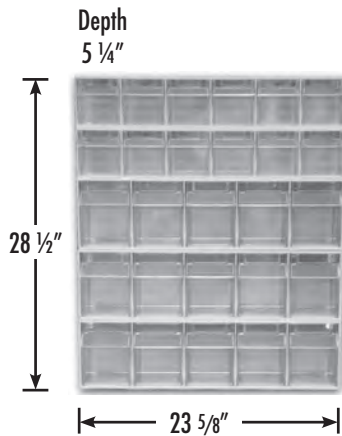

PART NO.	DESCRIPTION	QTY
F40002	1/4" Short Flare Nut	25
F40004	3/8" Short Flare Nut	50
F40005	1/2" Short Flare Nut	50
F40006	5/8" Short Flare Nut	25
F40020	3/8" Flare Cap	25
F40021	1/2" Flare Cap	25
F40023	1/4" Flare Union	25
F40025	3/8" Flare Union	25
F40026	1/2" Flare Union	25
F40027	5/8" Flare Union	10
F40035	3/8" Flare Tee	10
F40036	1/2" Flare Tee	10
F40048	3/8" OD x 3/8" FIP Coupling	20
F40049	3/8" OD x 1/2" FIP Coupling	20
F40052	1/2" OD x 3/8" FIP Coupling	20
F40053	1/2" OD x 1/2" FIP Coupling	20
F40055	5/8" OD x 1/2" FIP Coupling	15
F40063	1/4" OD x 1/8" MIP Half Union	20
F40064	1/4" OD x 1/4" MIP Half Union	20
F40068	3/8" OD x 1/4" MIP Half Union	20
F40069	3/8" OD x 3/8" MIP Half Union	25
F40070	3/8" OD x 1/2" MIP Half Union	25
F40073	1/2" OD x 3/8" MIP Half Union	25
F40074	1/2" OD x 1/2" MIP Half Union	25
F40076	5/8" OD x 1/2" MIP Half Union	15
F40088	3/8" OD x 3/8" MIP Elbow	10
F40092	1/2" OD x 1/2" MIP Elbow	10
Q01005	5-unit Tilt Bin Display	3
Q01006	6-unit Tilt Bin Display	2

Compression Fittings Assortment

Display Part No. Q01012

• Get 9 Multistore Bins FREE!

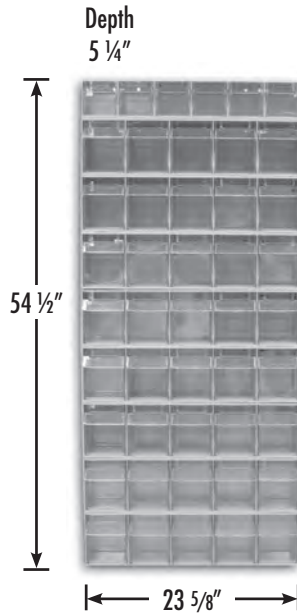

PART NO.	DESCRIPTION	QTY
C74005	1/4" OD Compression Sleeve	100
C74007	3/8" OD Compression Sleeve	100
C74008	1/2" OD Compression Sleeve	100
C74009	5/8" OD Compression Sleeve	100
C74014	1/4" OD Compression Sleeve	100
C74016	3/8" OD Compression Nut	100
C74017	1/2" OD Compression Nut	100
C74018	5/8" OD Compression Nut	100
C74023	1/4" OD Compression Union	50
C74025	3/8" OD Compression Union	100
C74026	1/2" OD Compression Union	50
C74027	5/8" OD Compression Union	50
C74029	7/8" OD Compression Union	25
C74030	3/8" x 1/4" Comp Reducing Union	25
C74031	1/2" x 3/8" Comp Reducing Union	25
C74032	5/8" x 3/8" Comp Reducing Union	25
C74034	1/4" OD Compression Tee	10
C74036	3/8" OD Compression Tee	20
C74038	1/2" OD Compression Tee	10
C74041	3/8" OD Compression Elbow	25
C74043	5/8" OD Compression Elbow	10
C74044	5/8" x 3/8" Compression Elbow	10
C74050	3/8" OD x 3/8" FIP Comp Union	25
C74051	3/8" OD x 1/2" FIP Comp Union	25
C74052	1/2" OD x 3/8" FIP Comp Union	25
C74053	1/2" OD x 1/2" FIP Comp Union	25
C74054	5/8" x OD x 1/2" FIP Comp Union	10
C74055	7/8" OD x 3/4" FIP Comp Union	10
C74058	1/4" OD x 1/8" MIP Comp Union	25
C74059	1/4" OD x 1/4" MIP Comp Union	25
C74060	1/4" OD x 3/8" MIP Comp Union	25
C74064	3/8" OD x 1/4" MIP Comp Union	25
C74065	3/8" OD x 3/8" MIP Comp Union	50
C74066	3/8" OD x 1/2" MIP Comp Union	50
C74069	1/2" OD x 3/8" MIP Comp Union	50
C74070	1/2" OD x 1/2" MIP Comp Union	50
C74071	5/8" OD x 1/2" MIP Comp Union	40
C74072	5/8" OD x 3/4" MIP Comp Union	25
C74073	7/8" OD x 3/4" MIP Comp Union	20
C74081	1/4" OD x 1/8" MIP Comp Elbow	25
C74082	1/4" OD x 1/4" MIP Comp Elbow	25
C74085	3/8" OD x 1/4" MIP Comp Elbow	25
C74086	3/8" OD x 3/8" MIP Comp Elbow	60
C74087	3/8" OD x 1/2" MIP Comp Elbow	25
C74088	1/2" OD x 3/8" MIP Comp Elbow	50
C74089	1/2" OD x 1/2" MIP Comp Elbow	25
Q01005	5-unit Tilt Bin Display	8
Q01006	6-unit Tilt Bin Display	1

Mini Compression Fittings Assortment

Display Part No. Q01030R

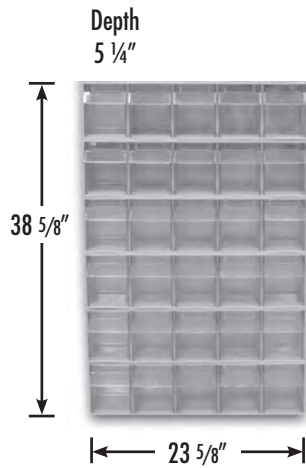

• Get 6 Multistore Bins FREE!

PART NO.	DESCRIPTION	QTY
C74096	1/4" OD Delrin Comp Sleeve	100
C74097	3/8" OD Delrin Comp Sleeve	100
C74098	1/2" OD Delrin Comp Sleeve	100
C74100	1/4" Brass Insert	100
C74101	3/8" Brass Insert	100
C74102	1/2" Brass Insert	40
C74005	1/4" OD Compression Sleeve	100
C74007	3/8" OD Compression Sleeve	100
C74008	1/2" OD Compression Sleeve	100
C74009	5/8" OD Compression Sleeve	100
C74016	3/8" OD Compression Nut	25
C74017	1/2" OD Compression Nut	25
C74023	1/4" OD Compression Nut	25
C74025	3/8" OD Compression Union	25
C74026	1/2" OD Compression Union	25
C74027	5/8" OD Compression Union	25
C74052	1/2" OD x 3/8" FIP Comp Union	25
C74059	1/4" OD x 1/4" MIP Comp Union	25
C74065	3/8" OD x 3/8" MIP Comp Union	25
C74070	1/2" OD x 1/2" MIP Comp Union	25
C74058	1/4" OD x 1/8" MIP Comp Union	25
C74064	3/8" OD x 1/4" MIP Comp Union	25
C74066	3/8" OD x 1/2" MIP Comp Union	25
C74069	1/2" OD x 3/8" MIP Comp Union	25
C74082	1/4" OD x 1/4" MIP Comp Elbow	25
C74086	3/8" OD x 3/8" MIP Comp Elbow	25
C74081	1/4" OD x 1/8" MIP Comp Elbow	25
C74085	3/8" OD x 1/4" MIP Comp Elbow	25
S92001	Self-piercing Needle Valve Kit	25
Q01005	5-unit Tilt Bin Display	6

Garden Hose Fitting Assortment

Display Part No. Q01014

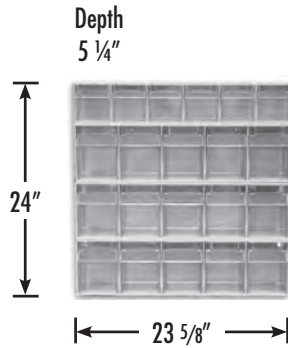

• Get 4 Multistore Bins FREE!

PART NO.	DESCRIPTION	QTY
G20002	3/4" MGH x 1/2" MIP	25
G20003	3/4" MGH x 3/4" MIP Tapped 1/2" FIP	25
G20008	3/4" MGH to 3/4" MGH	25
G20010	3/4" MGH x 1/2" FIP	10
G20011	3/4" MGH x 3/4" FIP	25
G20015	3/4" FGH x 1/2" MIP	10
G20016	3/4" FGH x 3/4" MIP	25
G20020	3/4" FGH x 1/2" FIP	10
G20021	3/4" FGH x 3/4" FIP	10
G20030	3/4" FGH Swivel	25
G20031	3/4" FGH x 1/2" FIP Swivel	25
G20032	3/4" FGH x 3/4" FIP Swivel	25
G20036	1/2" ID x 3/4" FGH Swivel Hose Barb	5
G20037	5/8" ID x 3/4" FGH Swivel Hose Barb	10
G20038	3/4" ID x 3/4" FGH Swivel Hose Barb	5
G20041	1/2" ID x 3/4" MGH Hose Barb	5
G20042	5/8" ID x 3/4" MGH Hose Barb	10
G20043	3/4" ID x 3/4" MGH Hose Barb	5
G20050	3/4" FGH x 3/4" MGH Wye	5
G20055	3/4" GH Cap	25
G20057	3/4" Hose Washer	200
Q01005	5-unit Tilt Bin Display	3
Q01006	6-unit Tilt Bin Display	1

Garden Hose/Pipe Fittings Assortment

Display Part No. Q01014R

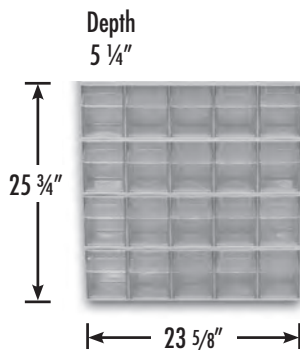

• Get 4 Multistore Bins FREE!

PART NO.	DESCRIPTION	QTY
G20002	3/4" MGH x 1/2" MIP	25
G20003	3/4" MGH x 3/4" MIP Tapped 1/2" FIP	25
G20008	3/4" MGH to 3/4" MGH	25
G20010	3/4" MGH x 1/2" FIP	10
G20011	3/4" MGH x 3/4" FIP	25
G20015	3/4" FGH x 1/2" MIP	10
G20016	3/4" FGH x 3/4" MIP	25
G20020	3/4" FGH x 1/2" FIP	10
G20021	3/4" FGH x 3/4" FIP	10
G20030	3/4" FGH Swivel	25
G20031	3/4" FGH x 1/2" FIP Swivel	25
G20032	3/4" FGH x 3/4" FIP Swivel	25
G20036	1/2" ID x 3/4" FGH Swivel Hose Barb	5
G20037	5/8" ID x 3/4" FGH Swivel Hose Barb	10
G20038	3/4" ID x 3/4" FGH Swivel Hose Barb	5
G20041	1/2" ID x 3/4" MGH Hose Barb	5
G20042	5/8" ID x 3/4" MGH Hose Barb	10
G20043	3/4" ID x 3/4" MGH Hose Barb	5
G20050	3/4" FGH x 3/4" MGH Wye	5
G20055	3/4" GH Cap	25
G20057	3/4" Hose Washer	200
Q01005	5-unit Tilt Bin Display	4

Brass Hose Barb Assortment

Display Part No. Q01016

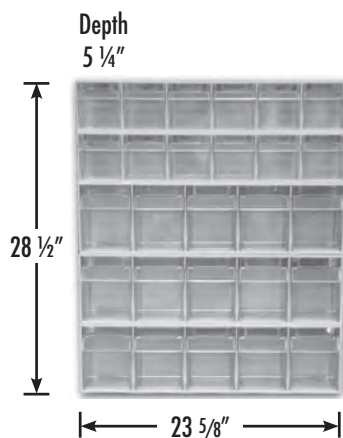

• Get 5 Multistore Bins FREE!

PART NO.	DESCRIPTION	QTY
G25032	3/16" ID x 1/8" MIP Hose Barb	10
G25042	1/4" ID x 1/8" MIP Hose Barb	10
G25044	1/4" ID x 1/4" MIP Hose Barb	24
G25046	1/4" ID x 3/8" MIP Hose Barb	10
G25048	1/4" ID x 1/2" MIP Hose Barb	10
G25052	5/16" ID x 1/8" MIP Hose Barb	10
G25054	5/16" ID x 1/4" MIP Hose Barb	10
G25064	3/8" ID x 1/4" MIP Hose Barb	20
G25066	3/8" ID x 3/8" MIP Hose Barb	30
G25068	3/8" ID x 1/2" MIP Hose Barb	10
G25084	1/2" ID x 1/4" MIP Hose Barb	25
G25086	1/2" ID x 3/8" MIP Hose Barb	15
G25088	1/2" ID x 1/2" MIP Hose Barb	40
G25106	5/8" ID x 3/8" MIP Hose Barb	20
G25108	5/8" ID x 1/2" MIP Hose Barb	25
G25101	5/8" ID x 3/4" MIP Hose Barb	25
G25121	3/4" ID x 3/4" MIP Hose Barb	10
G25128	3/4" ID x 1/2" MIP Hose Barb	5
G29004	1/4" ID Hose Splicer	100
G29005	5/16" ID Hose Splicer	100
G29006	3/8" ID Hose Splicer	95
G29008	1/2" ID Hose Splicer	70
G29010	5/8" ID Hose Splicer	50
N10544	1/4" OD x 1/4" OD St. Needle Valve	25
N10566	3/8" OD x 3/8" OD St. Needle Valve	25
N10642	1/4" OD x 1/8" MIP St. Needle Valve	25
N10664	3/8" OD x 1/4" MIP St. Needle Valve	25
Q01005	5-unit Tilt Bin Display	3
Q01006	6-unit Tilt Bin Display	2

Brass Hose Barb Display Assortment

Display Part No. Q01024R

• Get 4 Multistore Bins FREE!

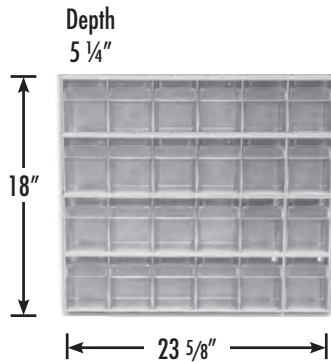

PART NO.	DESCRIPTION	QTY
G25022	1/8" ID x 1/8" MPT Adapter	20
G25042	1/4" ID x 1/8" MPT Hose Barb	20
G25044	1/4" ID x 1/4" MPT Hose Barb	30
G25052	5/16" ID x 1/8" MPT Hose Barb	5
G25054	5/16" ID x 1/4" MPT Hose Barb	5
G25062	3/8" ID x 1/8" MPT Hose Barb	10
G25064	3/8" ID x 1/4" MPT Hose Barb	30
G25066	3/8" ID x 3/8" MPT Hose Barb	20
G25068	3/8" ID x 1/2" MPT Hose Barb	20
G25084	1/2" ID x 1/4" MPT Hose Barb	10
G25086	1/2" ID x 3/8" MPT Hose Barb	10
G25088	1/2" ID x 1/2" MPT Hose Barb	20
G25812	1/2" ID x 3/4" MPT Hose Barb	5
G25106	5/8" ID x 3/8" MPT Hose Barb	5
G25108	5/8" ID x 1/2" MPT Hose Barb	10
G25101	5/8" ID x 3/4" MPT Hose Barb	10
G25121	3/4" ID x 3/4" MPT Hose Barb	10
G25128	3/4" ID x 1/2" MPT Hose Barb	5
G25169	1" ID x 1" MPT Hose Barb	5
G29004	1/4" ID Hose Splicer	10
G29005	5/16" ID Hose Splicer	10
G29006	3/8" ID Hose Splicer	20
G29008	1/2" ID Hose Splicer	10
G29010	5/8" ID Hose Splicer	10
Q01006	6-unit Tilt Bin Display	4

Yellow Brass & Bronze Pipe Fittings

Display Part No. Q01015

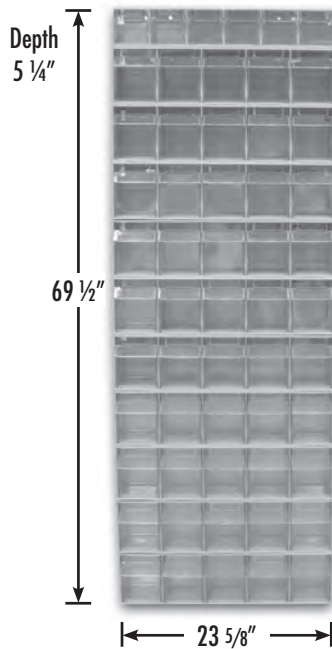

• Get 11 Multistore Bins FREE!

PART NO.	DESCRIPTION	QTY
B74001	1/8" 90° Pipe Elbow	10
B74002	1/4" 90° Pipe Elbow	10
B74003	3/8" 90° Pipe Elbow	10
B74004	1/2" 90° Pipe Elbow	20
B74005	3/4" 90° Pipe Elbow	20
B74006	1" 90° Pipe Elbow	5
P10012	1/8" Pipe Tee	10
B74082	1/4" Pipe Tee	10
B74083	3/8" Pipe Tee	5
B74084	1/2" Pipe Tee	10
B74085	3/4" Pipe Tee	10
B74086	1" Pipe Tee	10
P10032	1/8" Pipe Coupling	10
P10034	1/4" Pipe Coupling	10
B74123	3/8" Pipe Coupling	10
B74124	1/2" Pipe Coupling	20
B74125	3/4" Pipe Coupling	20
B74126	1" Pipe Coupling	10
P10082	1/8" Pipe Cap	10
P10084	1/4" Pipe Cap	10
P10086	3/8" Pipe Cap	10
B74184	1/2" Pipe Cap	25
B74185	3/4" Pipe Cap	25
B74186	1" Pipe Cap	10
P10092	1/8" Square Head Pipe Plug	25
P10094	1/4" Square Head Pipe Plug	50
P10096	3/8" Square Head Pipe Plug	25
B74284	1/2" Square Head Pipe Plug	30
B74285	3/4" Square Head Pipe Plug	30
B74286	1" Square Head Pipe Plug	10
P11042	1/4" x 1/8" Hex Bushing	25
P11062	3/8" x 1/8" Hex Bushing	25
P11064	3/8" x 1/4" Hex Bushing	20
P11084	1/2" x 1/4" Hex Bushing	20
P11086	1/2" x 3/8" Hex Bushing	50
P11124	3/4" x 1/4" Hex Bushing	10
P11126	3/4" x 3/8" Hex Bushing	10
P11128	3/4" x 1/2" Hex Bushing	50
B74212	1" x 1/2" Hex Bushing	20
B74213	1" x 3/4" Hex Bushing	25
P11202	1/8" x Close Pipe Nipple	25
P11204	1/4" x Close Pipe Nipple	25
P11206	3/8" x Close Pipe Nipple	25
P11208	1/2" x Close Pipe Nipple	25
N24000	3/4" x Close Pipe Nipple	25
N25000	1" x Close Pipe Nipple	10
P13232	1/8" x 2" Pipe Nipple	20
P13423	1/4" x 2" Pipe Nipple	20
P13632	3/8" x 2" Pipe Nipple	20

Yellow Brass & Bronze Pipe Fittings (cont.)

Display Part No. Q01015

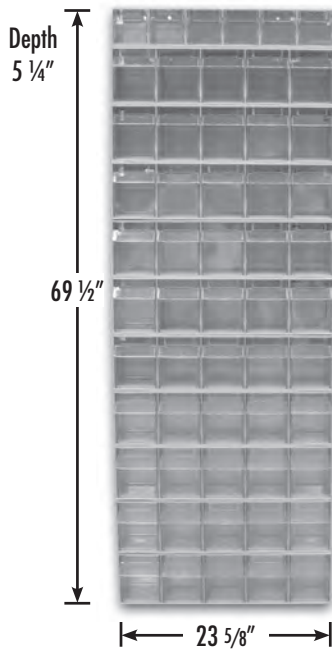

• Get 11 Multistore Bins FREE!

PART NO.	DESCRIPTION	QTY
N23002	1/2" x 2" Pipe Nipple	25
N24002	3/4" x 2" Pipe Nipple	25
N25002	1" x 2" Pipe Nipple	10
P16002	1/8" 90° Street Elbow	10
P16004	1/4" 90° Street Elbow	10
B74023	3/8" 90° Street Elbow	10
B74024	1/2" 90° Street Elbow	10
Q01005	5-unit Tilt Bin Display	10
Q01006	6-unit Tilt Bin Display	1

Nylon Insert Assortment

Display Part No. Q01028

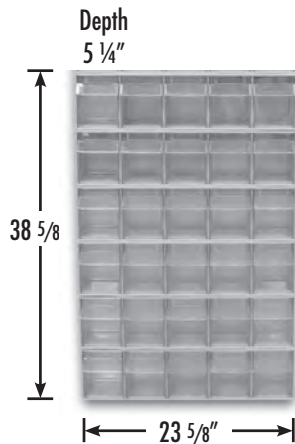

• Get 6 Multistore Bins FREE!

PART NO.	DESCRIPTION	QTY
I11001	1/2" Nylon Insert x MIP Adapter	15
I11002	3/4" Nylon Insert x MIP Adapter	20
I11003	1" Nylon Insert x MIP Adapter	20
I11004	1 1/4" Nylon Insert x MIP Adapter	15
I11005	1 1/2" Nylon Insert x MIP Adapter	15
I11006	2" Nylon Insert x MIP Adapter	10
I11007	1/2" Nylon Insert Coupling	15
I11008	3/4" Nylon Insert Coupling	20
I11009	1" Nylon Insert Coupling	20
I11010	1 1/4" Nylon Insert Coupling	15
I11011	1 1/2" Nylon Insert Coupling	15
I11012	2" Nylon Insert Coupling	10
I11013	1/2" Nylon Insert Elbow	15
I11014	3/4" Nylon Insert Elbow	20
I11015	1" Nylon Insert Elbow	20
I11016	1 1/4" Nylon Insert Elbow	15
I11017	1 1/2" Nylon Insert Elbow	15
I11018	2" Nylon Insert Elbow	10
I11019	1/2" Nylon Insert Tee	15
I11020	3/4" Nylon Insert Tee	20
I11021	1" Nylon Insert Tee	20
I11022	1 1/4" Nylon Insert Tee	15
I11023	1 1/2" Nylon Insert Tee	15
I11024	2" Nylon Insert Tee	10
I11025	1/2" Nylon Insert x MIP Comb Elbow	15
I11026	3/4" Nylon Insert x MIP Comb Elbow	20
I11027	1" Nylon Insert x MIP Comb Elbow	20
I11028	1 3/4" Nylon Insert x MIP Comb Elbow	10
Q01005	5-unit Tilt Bin Display	6

Poly Insert Assortment

Display Part No. Q01027

• Get 10 Multistore Bins FREE!

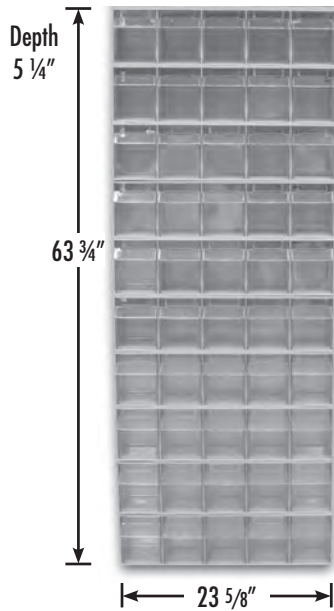

PART NO.	DESCRIPTION	QTY
I10001	1/2" Poly Insert x MIP Adapter	20
I10002	3/4" Poly Insert x MIP Adapter	25
I10003	1" Poly Insert x MIP Adapter	25
I10004	1 1/4" Poly Insert x MIP Adapter	15
I10005	1 1/2" Poly Insert x MIP Adapter	15
I10006	2" Poly Insert x MIP Adapter	10
I10007	1/2" Poly Insert x FIP Adapter	20
I10008	3/4" Poly Insert x FIP Adapter	20
I10009	1" Poly Insert x FIP Adapter	15
I10010	1 1/4" Poly Insert x FIP Adapter	10
I10011	1 1/2" Poly Insert Coupling	20
I10012	3/4" Poly Insert Coupling	25
I10013	1" Poly Insert Coupling	25
I10014	1 1/4" Poly Insert Coupling	15
I10015	1 1/2" Poly Insert Coupling	15
I10016	2" Poly Insert Coupling	10
I10017	3/4" x 1/2" Poly Insert Red Coupling	20
I10018	1" x 1/2" Poly Insert Red Coupling	10
I10019	1" x 3/4" Poly Insert Red Coupling	20
I10020	1 1/4" x 1" Poly Insert Red Coupling	20
I10021	1 1/2" x 1 1/4" Poly Insert Red Coupling	10
I10022	2" x 1 1/2" Poly Insert Red Coupling	5
I10023	1/2" Poly Insert Elbow	20
I10024	3/4" Poly Insert Elbow	25
I10025	1" Poly Insert Elbow	25
I10026	1 1/4" Poly Insert Elbow	15
I10027	1 1/2" Poly Insert Elbow	15
I10028	2" Poly Insert Elbow	10
I10029	1/2" Poly Insert Tee	20
I10030	3/4" Poly Insert Tee	25
I10031	1" Poly Insert Tee	25
I10032	1 1/4" Poly Insert Tee	15
I10033	1 1/2" Poly Insert Tee	15
I10034	2" Poly Insert Tee	10
I10035	1/2" Poly Insert x MIP Comb Elbow	20
I10036	3/4" Poly Insert x MIP Comb Elbow	20
I10037	1" Poly Insert x MIP Comb Elbow	15
I10038	1 1/4" Poly Insert x MIP Comb Elbow	10
I10039	1 1/2" Poly Insert x MIP Comb Elbow	10
I10040	3/4" MIP x 1/2" Poly Insert Adapter	20
I10041	1" MIP x 3/4" Poly Insert Adapter	15
I10042	1 1/4" MIP x 1" Poly Insert Adapter	10
I10043	3/4" x 3/4" 1/2" Poly Insert Red Tee	10
I10044	3/4" x 1/2" 1/2" Poly Insert Red Tee	10
I10045	1" x 1" x 1/2" Poly Insert Red Tee	10
I10046	1" x 1" x 3/4" Poly Insert Red Tee	10
I10047	1" x 3/4" x 3/4" Poly Insert Red Tee	10
I10048	1 1/2" x 1 1/2" x 1" Poly Insert Red Tee	10
I10049	2" x 2" x 1" Poly Insert Red Tee	5
Q01005	5-unit Tilt Bin Display	10

Drain & Flange Assortment (Bulk)

Display Part No. DFD100



*Gondola Not Included



C4743P



C53342



C85000



C87100



D40005



D40140



D50001

PART NO.	DESCRIPTION	QTY
C40420	4" x 2" CI No Caulk Closet Flange	1
C4743P	4" x 3" PVC Two Finger Flange	1
C51340	3" x 4" PVC Flange Less Knockout	3
C53340	3" x 4" PVC Flange w/ Metal Ring, Less KO	2
C53342	3" x 4" PVC Adjustable Flange w/ Plastic Swivel Ring, Less KO	3
C54402	3" x 4" PVC Offset Adjustable Flange w/ Plastic Swivel Ring	1
C85000	Metal Closet Flange	2
C87100	Gapper Flange	2
C88001	Closet Flange Extender	2
D40003	4 1/4" PB Snap-in Strainer for No Caulk Drain	1
D40005	4 1/4" SS Snap-in Strainer for No Caulk Drain	2
D40101	2" No Caulk Shower Drain with SS Strainer	2
D40140	2" No Caulk Brass Shower Stall Drain	1
D40600	2" x 3" Area Drain	2
D40601	3" x 4" Area Drain	2
D41001	2" Shower Drain with Receptor Base	2
D41009	2" PVC Drop-In Shower Drain w/ PB Strainer	1
D42006H	6" x 6" PVC Bell Trap with Hinged Lid	2
D50001	2" x 3" PVC Shower/Floor Drain w/ SS Strainer	2
D54100	3" x 4" PVC General Purpose Drain w/ SS Strainer	2
D59001	2" SS Push-in Strainer	2
D59002	3" SS Push-in Strainer	2
D59003	4" SS Push-in Strainer	2
S26004	3" x 2" PVC Saddle Tee Kit	2
S26005	4" x 2" PVC Saddle Tee Kit	2

Plumbing Specialties Display

Display Part No. Q01018

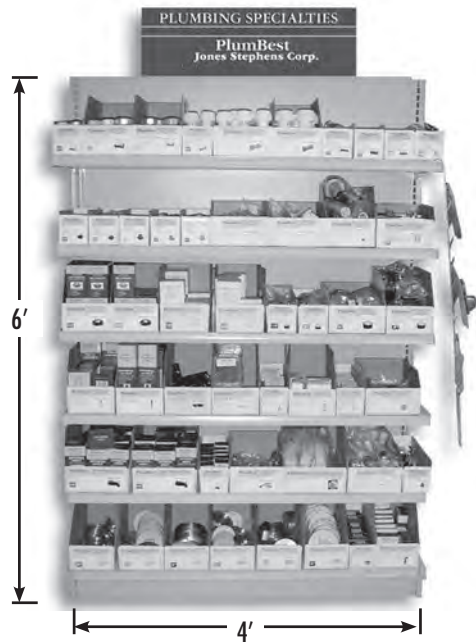

PART NO.	DESCRIPTION	QTY
C11050	1/2" IPS Galvanized Compression Coupling	10
C11075	3/4" IPS Galvanized Compression Coupling	10
C11100	1" IPS Galvanized Compression Coupling	10
C12050	1/2" IPS PVC Compression Coupling	12
C12075	3/4" IPS PVC Compression Coupling	10
C12100	1" IPS PVC Compression Coupling	10
C15050	1/2" CTS (3/8" IPS) Bronze Compression Coupling	10
C15075	3/4" CTS (1/2" IPS) Bronze Compression Coupling	10
D06753	3/4" MIP x 3" Dielectric Nipple	20
R60050	1/2" IPS / 3/4" CTS SS Repair Clamp	8
D06050	1/2" FIP x 1/2" SWEAT (5/8" OD) Dielectric Union	15
D06075	3/4" FIP x 3/4" SWEAT (7/8" OD) Dielectric Union	15
C27134	1" x 3/4" Urinal Spud	15
C27125	1 1/4" Closet Spud	12
C27150	1 1/2" Closet Spud	10
C02011	1/4" x 2 1/4" BP Closet Bolts/Round Washer	50 pair
T01001	Fit-All CP Tank Trip Lever with 9" Brass Arm	20
C05070	Douglas Plastic Flush Valve with SS Chain	6
R60075	3/4" x 6" SS Repair Clamp	8
E01050	1/2" CTS (5/8" OD) CP Low Pattern Escutcheon	200
E01075	3/4" CTS (7/8" OD) CP Low Pattern Escutcheon	200
F01050	1/2" CTS 5/8" OD F&C Plate - Light Gauge	100
F01075	3/4" CTS - 7/8" OD F&C Plate - Light Gauge	100
T31001	1 1/2" Economy Test Plug	16
T31002	2" Economy Test Plug	12
T31003	3" Economy Test Plug	12
T31004	4" Economy Test Plug	10
P35001	CP Brass Pop-Up	6
D70100	CP Commercial Grid Lav Drain	6
D10001	Dishwasher Connection with 2 Worm Gear Clamps	20
A33002	#10 x 1 1/4" Anchor Kit	6
J66300	300 PSI Water Test Gauge	6
G64030	30 lb. Gas Test Gauge Assembly	6
G60030	30 PSI 2" Pressure Gauge	10
C90600	6" SS Cleanout Cover	25
D01001	1/2" FIP CP Diverter Spout (nose)	8
D01004	1/2" CTS CP Diverter Spout (slip)	8
S01004	CP 1 5/8" Deluxe Die Cast Shower Head	10
S01044	1/2" x 6" CP Shower Arm and SS Flange	10
S92025	1/4" x 25' Icemaker Kit Poly Tubing	8
A10001	Air Gap	10
B10201	1 3/4" OD Cock Hole Cover	25
P51300	3" Countersunk Southern Code Brass Plug	15
P51350	3 1/2" Countersunk Southern Code Brass Plug	15
P51400	4" Countersunk Southern Code Brass Plug	15
P50300	3" Raised Head Southern Code Brass Plug	15
P50350	3 1/2" Raised Head Southern Code Brass Plug	15
P50400	4" Raised Head Southern Code Brass Plug	15
B02050	SS Junior Duo Basket Strainer	6
K52001	Kitchen Faucet Spray Head Only	10
C04004	Carded Blue Vinyl Flapper	12
C87100	Gapper Repair Flange	12
Q01018	4' Gondola with Five Shelves	1



PVC Plastic Specialties

Display Part No. Q01017

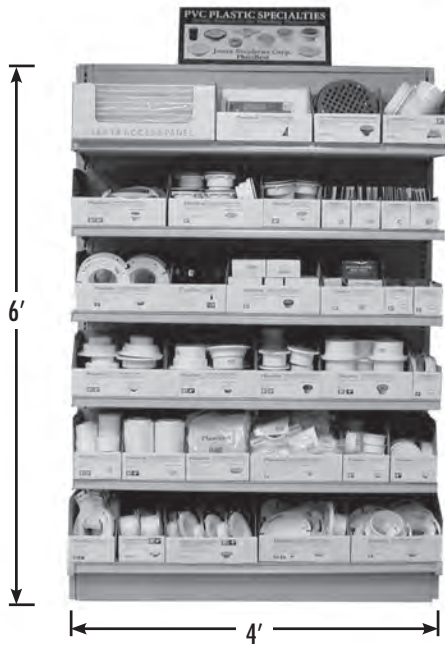

A04006



D41001



C4743P



H21050



C88001



C51340

PART NO.	DESCRIPTION	QTY
A05014	14" x 14" Snap-Ease Access Panel	10
A04006	6" x 9" Access Panel	10
D49827	8 1/2" Heavy Duty Traffic Floor Drain w/ Sediment Bucket	2
B04300	3" Backwater Valve	2
D50001	2" x 3" PVC Shower Drain w/ SS Strainer	8
D41001	2" PVC Shower Drain with SS Strainer & Receptor Base	15
D41600	2" PVC Offset Shower Stall Drain with SS Strainer	5
D41102	Polished Brass Replacement Strainer	5
C60810	4 1/4" SS Stamped Coverall Replacement Strainer	5
D40003	4 1/4" PB Snap-in Replacement Strainer	5
C60809	4 1/4" SS Stamped Coverall Replacement Strainer	5
C4743P	3" x 3" PVC Plastic Two Finger Flange	6
P21150	Provent	20
D40101	2" PVC NC Shower Drain with SS Strainer	15
D40140	2" PVC NC Shower Drain with SS Strainer - Brass Body	12
P48002	2" Socket Ring	20
P48003	3" Socket Ring	15
P48004	4" Socket Ring	10
D40600	2" x 3" PVC General Purpose Area Drain	6
D40601	3" x 4" PVC General Purpose Area Drain	6
D54001	2" x 3" PVC Drain with SS Strainer	12
D54100	3" x 4" PVC Drain with SS Strainer	10
C61023	2" x 3" Fit Flush Cleanout with 2" IPS plug - 2 3/8" OD	10
C61034	3" x 4" Fit Flush Cleanout with 3" IPS plug - 3 1/2" OD	10
H21050	50' Plastic Hanger Tape	10
F10002	2" Adjustable Urinal Flange Kit Socket Fit	10
C60007	3" PVC Internal Pipe Cleanout Fitting	10
C60008	4" Internal Pipe Cleanout Fitting	10
C88001	1/2" Closet Flange Extender	10
C57034	3" x 4" PVC Closet Flange with SS Ring and KO	4
C50340	3" x 4" PVC Closet Flange with KO	8
C51340	3" x 4" PVC Closet Flange w/o KO	8
C57134	3" x 4" PVC Closet Flange with SS Ring w/o KO	8
Q01017	4' Gondola with Five Shelves	1
-	Zip Strip for Hanging Carded Items	1

"Code Blue" Light Commercial Cast Iron

Display Part No. Q01031



Drain Spuds						
FITS SLOT #	PART NO.	IPS SIZE	SPUD MATERIAL	STRAINER SIZE / MATERIAL	STRAINER DIAMETER	QTY
4R	D60986	3 1/2"	Metal	4" NB	Round	6
2A	D60990	3 1/2"	Metal	5" CP	Round	6
3B	D60991	3 1/2"	Metal	5" PB	Round	6
4B	D60996	3 1/2"	Metal	5" NB	Round	6
5KK	C37810	3 1/2"	Metal	5" NB	Round	6

No Hub Drain Bodies						
FITS SLOT #	PART NO.	IPS SIZE	PAN	SPUD	HEIGHT	QTY
X37	D67200	2"	7"	3 1/2"	3 3/8"	6
X6	D65102	2"	7"	3 1/2"	2 1/2"	6

Cess Pool Drain						
FITS SLOT #	PART NO.	SIZE	STRAINER SIZE / MATERIAL	SPUD	HEIGHT	QTY
X18	D76703	3"	7" CI	Round	4 1/16"	4

No Caulk Drain Bodies						
FITS SLOT #	PART NO.	SIZE	PAN	SPUD	HEIGHT	QTY
X1	D65002	2"	7"	3 1/2"	2 1/2"	6

Gasket Connection Base					
FITS SLOT #	PART NO.	S.V. BASE x SPUD	HEIGHT	QTY	
10K	D62350	4" x 3 1/2" IPS	5 1/2"	6	

Accessories			
FITS SLOT #	PART NO.	DESCRIPTION	QTY
-	D65103	3" NH drain base with clamp ring	6

Recommended Items For Residential Display

Display Part No. Q01002

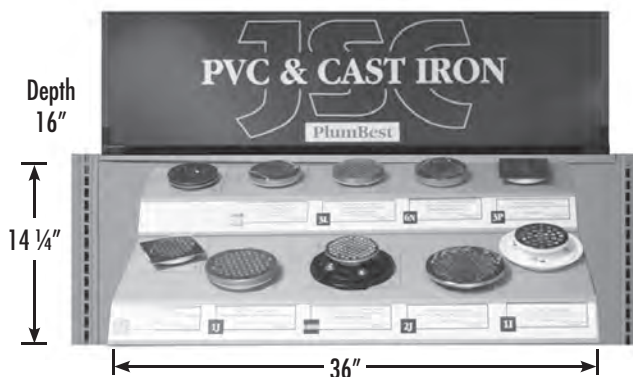

FITS SLOT #	PART NO.	IPS SIZE	SPUD MATERIAL	STRAINER/COVER SIZE / MATERIAL	STRAINER DIAMETER	QTY
2H	D60981	2"	Metal	4" CP	Round	6
3L	D60982	2"	Metal	4" PB	Round	6
2K	D50989	2"	Plastic	4" CP	Square	6
3P	D50990	2"	Plastic	4" PB	Square	6
2J	D60970	2"	Metal	6" CP	Round	6
1D	D40140	2"	Brass	SS	Round	12
10HH	D60103	2"	Cast Iron	4" SS	Round	6
1I	D50001	2" x 3"	Plastic	Bolt down 4" SS	Round	6
6N	D54022	2" x 3"	Plastic	4" CP with ring	Round	6
1J	D54112	3" x 4"	Plastic	4" PB with ring	Round	6
-	D40003	-	-	PB repl. strainer	Round	6
-	D40005	-	-	SS repl. strainer	Round	6
-	D40009	-	-	White Plastic repl. strainer	Round	6

Recommended Items For PVC Display

Display Part No. Q01000



FITS SLOT #	PART NO.	SIZE	SPUD MATERIAL	STRAINER SIZE / MATERIAL	STRAINER DIAMETER	QTY
1M	D56211		Plastic	5" SS	Round	6
2AA	D56216		Plastic	5" CP	Round	6
3S	D56212		Plastic	5" PB	Round	6
4N	D54214		Plastic	5" NB	Round	6
5FF	D59945		Plastic	5" NB	Round	6
4B	D60996		Metal	5" NB	Round	6

FITS SLOT #	PART NO.	CONNECTION SIZE	BASE MATERIAL	SPUD SIZE	PRIMER TAP	QTY
7	D52003	4"	Hub Fit	3 1/2"	-	6
8	D49804	3" x 4"	HD	3 1/2"	with 1/2" plug	10
9C	D52451	3" x 4"	Pipe Fit	3 1/2"	with 1/2" plug	12
10B	D52452	4"	Over Pipe Fit	3 1/2"	with 1/2" plug	6

Accessories

FITS SLOT #	PART NO.	DESCRIPTION	QTY
-	D49801	2" x 3" HD drain base w/ 3 1/2" spud size and primer tap	6
-	C60822	5" PB ring	6
-	C60823	5" NB ring	6
-	C60819	5" CP ring	6

Floweazy Drain Opener

Display Part No. S95994

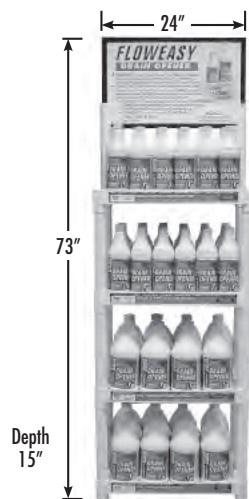

S95703 Quart



S95704 Half Gallon

PART NO.	DESCRIPTION	QTY
S95703	Floweazy Drain Opener (Quart)	84 + 12 FREE
S95704	Floweazy Drain Opener (1/2 Gallon)	24
S95900	4 Shelf White Plastic Display Rack w/Header	1

Floweazy Drain Opener

Display Part No. S95995

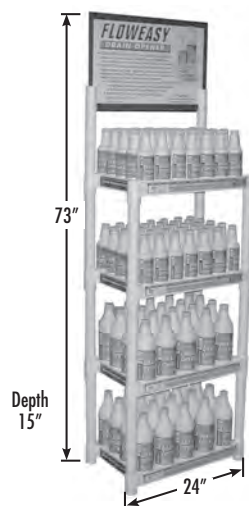

PART NO.	DESCRIPTION	QTY
S95701	Floweazy Drain Opener (Pint)	96
S95703	Floweazy Drain Opener (Quart)	48
S95900	4 Shelf White Plastic Display Rack w/Header	1

Floweazy Drain Opener

Display Part No. S95920



PART NO.	DESCRIPTION	QTY
S95701	Floweazy Drain Opener (Pint)	48 + 6 FREE
S95703	Floweazy Drain Opener (Quart)	24
S95704	Floweazy Drain Opener (1/2 Gallon)	12
S95900	White Plastic Display Rack w/Header	1

Floweazy Drain Opener (36 qt)

Display Part No. S95968



PART NO.	DESCRIPTION	QTY
S95703	Floweazy Drain Opener (Quart)	36
S95900	White Plastic Display Rack w/Header	1

Floweazy Drain Opener

Display Part No. S95999

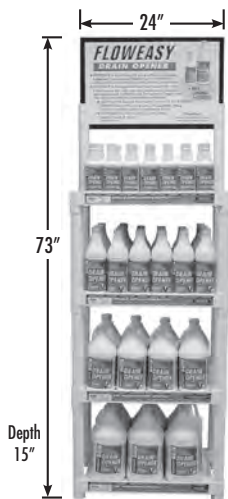

PART NO.	DESCRIPTION	QTY
S95701	Floweazy Drain Opener (Pint)	36
S95703	Floweazy Drain Opener (Quart)	24
S95704	Floweazy Drain Opener (1/2 Gallon)	12
S95705	Floweazy Drain Opener (Gallon)	8
S95900	4 Shelf White Plastic Display Rack w/Header	1

Coil Cleaner

Display Part No. Q01COIL



PART NO.	DESCRIPTION	QTY
S95721	A.C. Coil Cleaner (Quart/RTU)	24
S95722	Condenser Coil Cleaner (Gallon/Concentrate)	8
S95725	Condenser Coil Cleaner (Gallon/RTU)	8
S95900	White Plastic Display Rack w/Header	1

Wypall® Waterless Handwipes

Display Part No. B05008



PART NO.	DESCRIPTION	QTY
B05007	50-count Dispenser Tub	30

Floweazy Drain Opener & Wypall® Waterless Handwipes

Display Part No. S95921

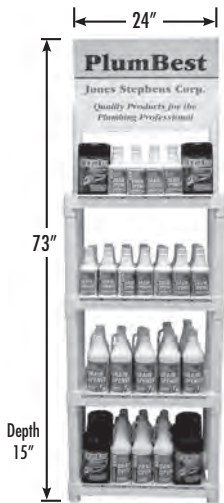

PART NO.	DESCRIPTION	QTY
S95701	Floweazy Drain Opener (Pint)	48 + 6 FREE
S95703	Floweazy Drain Opener (Quart)	36
B05007	Wypall® Tub (50-ct)	24 + 1 FREE
S95900	4 Shelf White Plastic Display Rack w/Header	1

Heating & Cooling Maintenance Assort.

Display Part No. S95967



PART NO.	DESCRIPTION	QTY
S95721	AC (Inside) Coil Cleaner Ready-to-Use	12
S95722	AC (Outside) Coil Cleaner Concentrate	8
S95725	AC (Outside) Coil Cleaner Ready-to-Use	8
S95732	PlumBest Electrical Lubricant	12
S95734	Clear-A-Line Condensate Line Treatment	12
S95736	Spritz Gas Leak Detector	12
S95738	Pan-Gel Condensation Pan Tablet	12
S95900	4 Shelf White Plastic Display Rack w/Header	1

B		Stainless Steel Connectors	4
Braided Plumbing Connectors Assortment	5	Assortment	5
Brass Assortment, Complete	6	Extended Assortment	4
Brass Flare Tube Fittings Assortment	8	Straps	
Brass Hose Barb	12	Cam	4
Assortment	12	Utility Tie-Down	3
Display Assortment	13	T	
Bronze & Yellow Brass Pipe Fittings	14	Tool Board	2
C		Tool Center	1
Cam Straps	4	U	
Cast Iron, "Code Blue" Light Commercial	20	Utility Tie-Down Strap	3
"Code Blue" Light Commercial Cast Iron	20	W	
Coil Cleaner	23	Work Gloves	4
Complete Brass Assortment	6	Wypall Waterless Handwipes	24
Compression Fittings Assortment	9	Wypall Waterless Handwipes & Floweasy Drain Opener	24
Connectors		Y	
Braided Plumbing, Assortment	5	Yellow Brass & Bronze Pipe Fittings	14
Stainless Steel, Assortment	5		
Stainless Steel, Extended Assortment	4		
Cooling & Heating Maintenance Assort	24		
Cutting Board	1		
D			
Drain & Flange Assortment (Bulk)	17		
F			
Fittings Assortment	8		
Brass Flare Tube	8		
Compression	9		
Garden Hose	11		
Garden Hose/Pipe	11		
Mini Compression	10		
Flange & Drain Assortment (Bulk)	17		
Flare Fittings Assortment	7		
Floweasy Drain Opener	22		
Floweasy Drain Opener & Wypall Waterless Handwipes	24		
G			
Garden Hose Fitting Assortment	11		
Garden Hose/Pipe Fittings Assortment	11		
Gloves, Work	4		
H			
Heating & Cooling Maintenance Assort	24		
L			
Light Commercial Cast Iron, "Code Blue"	20		
M			
Mini Compression Fittings Assortment	10		
N			
Nylon Insert Assortment	15		
P			
Pipe Fittings	14		
Yellow Brass & Bronze	14		
Plumbing Specialties Display	18		
Poly Insert Assortment	16		
PVC Display, Recommended Items For	21		
PVC Plastic Specialties	19		
R			
Recommended Items For			
PVC Display	21		
Residential Display	20		
Residential Display, Recommended Items For	20		
S			
Socket Saver	2		

PART NO.	DESCRIPTION	PG #
B05008	Wypall® Waterless Handwipes	24
BNC100	Braided Plumbing Connectors Assortment	5
DFD100	Drain & Flange Assortment (Bulk)	17
G50200	Work Gloves	4
G50204	Work Gloves	4
G50208	Work Gloves	4
Q01000	Recommended Items for PVC Display	21
Q01002	Recommended Items for Residential Display	20
Q01011	Complete Brass Assortment	6
Q01012	Compression Fittings Assortment	9
Q01013	Flare Fittings Assortment	7
Q01013R	Brass Flare Tube Fittings Assortment	8
Q01014	Garden Hose Fitting Assortment	11
Q01014R	Garden Hose/Pipe Fittings Assortment	11
Q01015	Yellow Brass & Bronze Pipe Ftgs.	14-15
Q01016	Brass Hose Barb Assortment	12
Q01017	PVC Plastic Specialties	19
Q01018	Plumbing Specialties Display	18
Q01024R	Brass Hose Barb Display Assortment	13
Q01027	Poly Insert Assortment	16
Q01028	Nylon Insert Assortment	15
Q01030R	Mini Compression Fittings Assortment	10
Q01031	"Code Blue" Light Commercial Cast Iron	20
Q01COIL	Coil Cleaner	23
RTB100	PlumBest Tool Board	2
S04303	Stainless Steel Connectors Assortment	5
S20001	Utility Tie-Down Strap	3
S20999	Cam Straps	4
S95920	Floweasy Drain Opener	22
S95921	Floweasy Drain Opener & Wypall® Waterless Handwipes	24
S95967	Heating & Cooling Maintenance Assortment	24
S95968	Floweasy Drain Opener (36 qt)	23
S95994	Floweasy Drain Opener	22
S95995	Floweasy Drain Opener	22
S95999	Floweasy Drain Opener	23
SSC100	Stainless Steel Connectors Extended Assortment	4
TB1100	PlumBest Tool Center	1
TB1200	PlumBest Cutting Board	1
TB1300	PlumBest Socket Saver	2

PART NO.	DESCRIPTION	PG #
TB1600	PlumBest Tool Board	2
TB1700	Complete Tool Center	3



SECTION T - TUBULAR

VOLUME V



Quality
Products *for*
the Plumbing
Professional

Chrome Plated 1-6

Rough Brass..... 7

PVC Plastic 8-10

ABS Plastic 11-13

Bath Wastes..... 14

Lav Drains & Pop Ups..... 14-15

Waste Connectors 17

Basket Strainers..... 18-19

Escutcheons & Trap Covers..... 20

Product Index..... 21

Part Number Index..... 22-24

Chrome Plated Brass P-Traps



- Heavy zinc nuts
- Shallow escutcheon
- Less cleanout

PART NO.	SIZE	GAUGE	CTN QTY
P38001	1-1/4"	22	30
P38002	1-1/4"	20	30
P38003	1-1/4"	17	30
P38004	1-1/2"	22	30
P38005	1-1/2"	20	30
P38006	1-1/2"	17	30

Chrome Plated Brass P-Traps



- Brass nuts
- Shallow escutcheon
- Less cleanout

PART NO.	SIZE	GAUGE	CTN QTY
P38091	1-1/4"	22	30
P38007	1-1/4"	20	30
P38138	1-1/4" x 1-1/2"	17	30
P38092	1-1/4"	17	30
P38093	1-1/2"	22	30
P38008	1-1/2"	20	30
P38094	1-1/2"	17	30

Chrome Plated Brass P-Traps



- Brass nuts
- Box escutcheon
- Less cleanout

PART NO.	SIZE	GAUGE	CTN QTY
P38003B	1-1/4"	17	30
P38005B	1-1/2"	20	30
P38006B	1-1/2"	17	30

Chrome Plated Brass P-Traps



- Heavy zinc nuts
- With cleanout
- Bell escutcheon

PART NO.	SIZE	GAUGE	CTN QTY
P38002B	1-1/4"	20	30

Boston Style P-Trap



- Brass nuts
- With cleanout
- Box escutcheon

PART NO.	SIZE	GAUGE	CTN QTY
P38142	1-1/4" x 1-1/2"	17	30

Chrome Plated Brass P-Traps



- Zinc nuts
- Shallow escutcheon
- With cleanout

PART NO.	SIZE	GAUGE	CTN QTY
P38009	1-1/4"	20	30
P38009B (box esc.)	1-1/4"	20	30
P38011	1-1/2"	20	30

Chrome Plated Brass P-Traps



- Brass nuts
- Shallow escutcheon
- With cleanout

PART NO.	SIZE	GAUGE	CTN QTY
P38010	1-1/4"	17	30
P38012	1-1/2"	17	30

Chrome Plated Brass P-Traps



- Brass nuts
- Box escutcheon
- With cleanout

PART NO.	SIZE	GAUGE	CTN QTY
P38010B	1-1/4"	17	30
P38012B	1-1/2"	17	30

Chrome Plated Brass P-Traps



- Brass nuts
- With cleanout
- Semi- cast commercial
- Shallow escutcheon

PART NO.	SIZE	GAUGE	CTN QTY
J37124	1-1/4"	17	30
J37150	1-1/2"	17	30

Sink Trap w/Sweat Connection



- Brass nuts
- Box escutcheon
- With cleanout

PART NO.	SIZE	GAUGE	CTN QTY
P38140	1-1/2"	17	30

Sink Trap w/ABS Adapter



- Brass nuts
- Box escutcheon
- With cleanout

PART NO.	SIZE	GAUGE	CTN QTY
P38141	1-1/2"	17	40

Chrome Plated Brass S-Traps



- Zinc nuts
- Shallow escutcheon
- Less cleanout

PART NO.	SIZE	GAUGE	CTN QTY
P38013	1-1/4"	22	15
P38014	1-1/2"	22	15

Chrome Plated Brass S-Traps



- Brass nuts
- Box escutcheon
- Less cleanout

PART NO.	SIZE	GAUGE	CTN QTY
P38095	1-1/4"	20	15
P38096	1-1/2"	20	15
P38137	1-1/4"	17	15
P38097	1-1/2"	17	15

Chrome Plated Brass J-Bend



- Heavy zinc nuts
- Slip Joint
- Less cleanout

PART NO.	SIZE	GAUGE	CTN QTY
P38015	1-1/4"	22	36
P38016	1-1/4"	20	36
P38017	1-1/4"	17	36
P38018	1-1/2"	22	36
P38019	1-1/2"	20	36
P38020	1-1/2"	17	36

Chrome Plated Brass J-Bend w/Cleanout



- Brass nuts
- Slip joint
- With cleanout

PART NO.	SIZE	GAUGE	CTN QTY
P38021	1-1/4"	17	36
P38022	1-1/2"	17	36

Chrome Plated Brass J-Bend w/Cleanout



- Heavy zinc nuts
- Slip joint
- Less cleanout

PART NO.	SIZE	GAUGE	CTN QTY
P38113	1-1/4"	20	60
P38114	1-1/2"	20	60

Chrome Plated Brass J-Bend



- Captured brass nuts
- Washer joint
- Less cleanout

PART NO.	SIZE	GAUGE	CTN QTY
P38107	1-1/4"	22	60
P38108	1-1/4"	20	60
P38109	1-1/4"	17	60
P38110	1-1/2"	22	60
P38111	1-1/2"	20	60
P38112	1-1/2"	17	60

Chrome Plated Brass L.A. Pattern Sink Trap



- P38099 and P38100 with cast brass elbows
- Brass nuts
- Less cleanout

PART NO.	SIZE	GAUGE	CTN QTY
P38098	1-1/2"	22	60
P38099	1-1/2"	20	60
P38100	1-1/2"	17	60

Chrome Plated Brass Repair Traps



- Heavy zinc nuts
- Less cleanout

PART NO.	SIZE	GAUGE	CTN QTY
P38101	1-1/4"	22	60
P38102	1-1/4"	20	60
P38103	1-1/2"	22	60
P38104	1-1/2"	20	60

Chrome Plated Brass Repair Traps



- Brass nuts
- Less cleanout

PART NO.	SIZE	GAUGE	CTN QTY
P38105	1-1/4"	17	60
P38106	1-1/2"	17	60

Milwaukee Style Trap



- Brass nuts
- 10" Arm
- Cast elbow
- With cleanout

PART NO.	SIZE	GAUGE	CTN QTY
P38129	1-1/2"	17	30

Sink Trap with PVC Adapter



- Box escutcheon
- PVC adapter
- Brass nuts
- With cleanout

PART NO.	SIZE	GAUGE	CTN QTY
P38130	1-1/2"	17	40

Chrome Brass P-Trap



- Bell escutcheon
- Brass nuts
- Less cleanout

PART NO.	SIZE	GAUGE	CTN QTY
P38150	1-1/4"	17	30

Brass Slip Joint End Outlet Tee Only



- Zinc nuts
- 4" Tailpiece
- No baffle

PART NO.	SIZE	GAUGE	CTN QTY
P38023	1-1/2"	22	50
P38024	1-1/2"	20	50

Brass Direct Connection End Outlet Waste



- Zinc nuts
- 4" Tailpiece
- No baffle

PART NO.	SIZE	GAUGE	CTN QTY
P38025	1-1/2" x 16"	22	20
P38026	1-1/2" x 16"	20	20

Brass Slip Joint End Outlet Waste



- Zinc nuts
- 4" Tailpiece
- No baffle

PART NO.	SIZE	GAUGE	CTN QTY
P38027	1-1/2" x 16"	22	20
P38028	1-1/2" x 16"	20	20

Brass Slip Joint Center Outlet Tee



- Zinc nuts
- 4" Tailpiece
- No baffle

PART NO.	SIZE	GAUGE	CTN QTY
P38029	1-1/2"	20	50

Brass Slip Joint Center Outlet Waste



- Zinc nuts
- 4" Tailpiece
- No baffle

PART NO.	SIZE	GAUGE	CTN QTY
P38030	1-1/2" x 16"	22	20
P38031	1-1/2" x 16"	20	20

Brass Direct Connection Center Outlet Waste



- Zinc nuts
- 4" Tailpiece
- No baffle

PART NO.	SIZE	GAUGE	CTN QTY
P38032	1-1/2" x 16"	22	20
P38033	1-1/2" x 16"	20	20

Brass Slip Joint Waste Arm



- Zinc nuts
- Bagged

PART NO.	SIZE	GAUGE	CTN QTY
P38034	1-1/4" x 6"	22	100
P38035	1-1/4" x 8"	22	50
P38036	1-1/4" x 12"	22	50
P38037	1-1/4" x 16"	22	50
P38038	1-1/2" x 8"	22	50
P38039	1-1/2" x 12"	22	50
P38040	1-1/2" x 16"	22	50
P38238	1-1/2" x 7"	17	50

Chrome Plated Brass Wall Bend



- Bagged

PART NO.	SIZE	GAUGE	CTN QTY
P38041	1-1/4" x 7"	22	100
P38042	1-1/4" x 7"	20	100
P38115	1-1/4" x 7-1/2"	17	100
P38043	1-1/2" x 7-1/2"	22	100
P38044	1-1/2" x 7-1/2"	20	100
P38116	1-1/2" x 7-1/2"	17	100

CP Brass Direct Connection Waste Arm



- Bagged

PART NO.	SIZE	GAUGE	CTN QTY
P38045	1-1/2" x 7"	22	100
P38117	1-1/2" x 15"	22	50
P38217	1-1/2" x 15"	17	100

Brass Slip Joint Double Offset



- Zinc nuts
- Bagged

PART NO.	SIZE	GAUGE	CTN QTY
P38046	1-1/4" x 12"	22	50
P38047	1-1/2" x 12"	22	50

Brass Sink Tailpiece



- Bagged

PART NO.	SIZE	GAUGE	CTN QTY
P38048	1-1/4" x 6"	22	100
P38049	1-1/4" x 8"	22	100
P38050	1-1/4" x 12"	22	100
P38051	1-1/4" x 6"	17	100
P38052	1-1/4" x 8"	17	100
P38053	1-1/4" x 12"	17	50
P38054	1-1/2" x 4"	22	100
P38055	1-1/2" x 6"	22	100
P38056	1-1/2" x 8"	22	100
P38057	1-1/2" x 12"	22	50
P38058	1-1/2" x 6"	17	100
P38059	1-1/2" x 8"	17	100
P38060	1-1/2" x 12"	17	50

Brass Double Flange Tailpiece



- Bagged

PART NO.	SIZE	GAUGE	CTN QTY
P38061	1-1/2" x 16"	22	50

Brass Direct Connect Dishwasher Tailpiece



- Zinc nut
- Bagged

PART NO.	SIZE	GAUGE	CTN QTY
P38063	1-1/2" x 6" w/3/4" branch	22	100
P38064	1-1/2" x 8" w/3/4" branch	22	50
P38163	1-1/2" x 6" w/1/2" branch	22	50
P38148	1-1/2" x 8" w/1/2" branch	22	50

Threaded Connection Dishwasher Tailpiece



PART NO.	SIZE	GAUGE	CTN QTY
P38166	1-1/2" x 6" w/1/2" branch	22	50

Slip Joint Tailpiece



- Zinc nut
- Bagged

PART NO.	SIZE	GAUGE	CTN QTY
P38164	1-1/2" x 8" w/3/4" branch	22	50
P38143	1-1/2" x 8" w/1/2" branch	22	50

Brass Double Slip Joint Extension Tube



- Zinc nuts
- Bagged

PART NO.	SIZE	GAUGE	CTN QTY
P38062	1-1/2" x 16"	22	50
P38162	1-1/4" x 16"	22	50

Chrome Plated Brass Slip Joint Extension Tube



- Zinc nut
- Bagged

PART NO.	SIZE	GAUGE	CTN QTY
P38065	1-1/4" x 6"	22	100
P38066	1-1/4" x 8"	22	100
P38067	1-1/4" x 12"	22	50
P38121	1-1/4" x 6"	20	100
P38122	1-1/4" x 8"	20	100
P38068	1-1/4" x 12"	20	50
P38118	1-1/4" x 6"	17	100
P38119	1-1/4" x 8"	17	100
P38120	1-1/4" x 12"	17	50
P38069	1-1/2" x 6"	22	100
P38070	1-1/2" x 8"	22	100
P38071	1-1/2" x 12"	22	50
P38123	1-1/2" x 6"	20	100
P38124	1-1/2" x 8"	20	100
P38125	1-1/2" x 12"	20	50
P38126	1-1/2" x 6"	17	100
P38127	1-1/2" x 8"	17	100
P38128	1-1/2" x 12"	17	50

Chrome Plated Closet Flush Elbow w/Nuts



- Zinc nuts
- Bagged

PART NO.	SIZE	GAUGE	CTN QTY
P38257	2" x 5" x 7"	20	25

Chrome Plated Disposer Kit



- Zinc nuts

PART NO.	SIZE	GAUGE	CTN QTY
P38165	1-1/2" x 13"	17	100

Brass Solder Extension Tube



PART NO.	SIZE	GAUGE	CTN QTY
P38072	1-1/4" x 6"	22	100
P38073	1-1/4" x 8"	22	100
P38074	1-1/4" x 12"	22	100
P38131	1-1/4" x 6"	20	100
P38132	1-1/4" x 8"	20	100
P38133	1-1/4" x 12"	20	100
P38075	1-1/4" x 6"	22	100
P38076	1-1/2" x 8"	22	100
P38077	1-1/2" x 12"	22	100
P38134	1-1/2" x 6"	20	100
P38135	1-1/2" x 8"	20	100
P38136	1-1/2" x 12"	20	100

Brass Threaded Extension Tube



• Bagged

PART NO.	SIZE	GAUGE	CTN QTY
P38078	1-1/4" x 6"	20	100
P38079	1-1/4" x 8"	20	100
P38080	1-1/4" x 12"	20	50
P38081	1-1/2" x 6"	20	100
P38082	1-1/2" x 8"	20	100
P38083	1-1/2" x 12"	20	50
P38084	1-1/4" x 6"	17	100
P38085	1-1/4" x 8"	17	100
P38086	1-1/4" x 12"	17	50
P38087	1-1/2" x 6"	17	100
P38088	1-1/2" x 8"	17	100
P38089	1-1/2" x 12"	17	50

Brass Waste Arm



• Zinc nut
• Boxed

PART NO.	SIZE	GAUGE	CTN QTY
P38139	1-1/2" x 36"	17	30

Slip Joint Tee



• Zinc nuts
• Chrome plated satin finish cast brass

PART NO.	DESCRIPTION	CTN QTY
C74105	1-1/2" x 1-1/2" x 1-1/2"	120

Double Slip Fittings



• Zinc nuts
• Chrome plated brass
• 22 gauge

PART NO.	SIZE	DESCRIPTION	CTN QTY
T74001	1-1/4"	Coupling	100
T74002	1-1/2"	Coupling	100
T74003	1-1/4"	90° Ell	100
T74004	1-1/2"	90° Ell	100
T74005	1-1/4"	45° Ell	100
T74006	1-1/2"	45° Ell	100

Rough Brass P-Trap



- Less cleanout
- Deep flange
- Brass Nuts

PART NO.	SIZE	GAUGE	CTN QTY
P38406	1-1/2"	17	30

Slip Joint Extension Tube



- Brass nut

PART NO.	SIZE	GAUGE	CTN QTY
P38420	1-1/4" x 12"	17	50
P38428	1-1/2" x 12"	17	50

Rough Brass Direct Connection Waste Arm



PART NO.	SIZE	GAUGE	CTN QTY
P38444	1-1/2" x 7"	17	100
P38447	1-1/2" x 15"	17	50

Double Threaded Extension Tube



PART NO.	SIZE	GAUGE	CTN QTY
P38486	1-1/4" x 12"	17	50
P38489	1-1/2" x 12"	17	50

Rough Brass Flanged Tailpiece



PART NO.	SIZE	GAUGE	CTN QTY
P38454	1-1/2" x 4"	17	100
P38458	1-1/2" x 6"	17	100
P38459	1-1/2" x 8"	17	100
P38460	1-1/2" x 12"	17	50

Rough Brass Slip Joint Tailpiece w/ 1/2" Sweat Branch



- Brass nut

PART NO.	SIZE	GAUGE	CTN QTY
P38443	1-1/2" x 8"	17	50

PVC P-Trap



PART NO.	SIZE	CTN QTY
P37001	1-1/4"	100
P37002	1-1/2"	50

PVC P-Trap w/Marvel; PVC P-Trap w/Solvent Weld Marvel



• Master trap

PART NO.	SIZE	CTN QTY
P37003	1-1/2" slip joint	50
P37032	1-1/2" solvent weld	50

PVC Slip Joint Center Outlet Waste



• Baffle tee

PART NO.	SIZE	CTN QTY
P37004	1-1/2"	40

PVC Direct Connection Center Outlet Waste



• Baffle tee

PART NO.	SIZE	CTN QTY
P37005	1-1/2"	40

PVC Center Outlet Tee Only



- Baffle
- Tailpiece included
- May be used as slipjoint or direct connect

PART NO.	SIZE	CTN QTY
P37006	1-1/2"	100

PVC Slip Joint End Outlet Waste



• Baffle

PART NO.	SIZE	CTN QTY
P37007	1-1/2" x 16"	40
P37034	1-1/2" x 16" Adjustable arm	40

PVC Slip Joint End Outlet Waste



- 1/2" branch
- Adjustable arm

PART NO.	SIZE	CTN QTY
P37042	1-1/2"	40

PVC Direct Connection End Outlet Waste



• Baffle tee

PART NO.	SIZE	CTN QTY
P37008	1-1/2"	40
P37036	1-1/2" telescoping	50

PVC Slip Joint End Outlet Tee Only w/Baffle



• Baffle

PART NO.	SIZE	CTN QTY
P37009	1-1/2"	100

PVC Slip Joint S-Trap



PART NO.	SIZE	CTN QTY
P37010	1-1/4"	60
P37011	1-1/2"	60

PVC Slip Joint Dishwasher Tailpiece



PART NO.	SIZE	CTN QTY
P37012	1-1/2" x 8" x 1/2"	25
P37030	1-1/2" x 8" x 3/4"	25

PVC Direct Connection Dishwasher Tailpiece



• Slip joint or direct connect

PART NO.	SIZE	CTN QTY
P37013	1-1/2" x 8" x 1/2"	25
P37031	1-1/2" x 8" x 3/4"	25

Universal End Outlet Waste w/Dishwasher Connection



- 1-1/2" tubular; 16" maximum adjustment
- Baffle tee
- Slip joint or direct connect

PART NO.	SIZE	CTN QTY
P37040	1/2" branch	60
P37041	3/4" branch	60

PVC Slip Joint Repair Trap



PART NO.	SIZE	CTN QTY
P37014	1-1/2"	80

PVC Slip Joint J-Bend



PART NO.	SIZE	CTN QTY
P37015	1-1/2"	60

PVC Slip Joint Waste Arm



PART NO.	SIZE	CTN QTY
P37016	1-1/2" x 16"	100

PVC Direct Connection Waste Arm



PART NO.	SIZE	CTN QTY
P37017	1-1/2" x 16"	100

PVC Slip Joint Extension Tube



PART NO.	SIZE	CTN QTY
P37018	1-1/2" x 16"	50
P37118	1-1/4" x 16"	50

PVC Double Flange Extension



PART NO.	SIZE	CTN QTY
P37019	1-1/2" x 16"	100
P37037	1-1/4" x 16"	100

PVC Slip Joint Extension Tube



PART NO.	SIZE	CTN QTY
P37020	1-1/4" x 6"	100
P37021	1-1/2" x 8"	100
P37022	1-1/2" x 12"	100

PVC Solvent Extension Tube



PART NO.	SIZE	CTN QTY
P37023	1-1/4" x 8"	100
P37024	1-1/2" x 6"	100
P37025	1-1/2" x 12"	100

PVC Flanged Tailpiece



PART NO.	SIZE	CTN QTY
P37026	1-1/2" x 6"	200
P37027	1-1/2" x 8"	200
P37028	1-1/2" x 12"	200
P37029	1-1/2" x 16"	100
P37038	1-1/4" x 12"	200

1-1/2" PVC Direct Connection Disposer Kit w/13" Arm



- Poly washers and wing nuts
- Disposer washer
- Baffle tee
- 6" Tailpiece

PART NO.	SIZE	CTN QTY
P37033	1-1/2" x 16"	50

1-1/2" PVC Direct Connection Disposer Kit w/Adjustable Arm



- Telescoping arm adjusts up to 16"
- Poly washers and wing nuts
- Disposer washer
- Baffle tee
- 6" tailpiece

PART NO.	SIZE	CTN QTY
P37035	1-1/2" x 16"	40

PVC Slip Joint Tee



PART NO.	SIZE	CTN QTY
P37400	1-1/2" with 1-1/4" washer	120

PVC Double Slip Fittings



PART NO.	SIZE	DESCRIPTION	CTN QTY
P37200	1-1/2"	Coupling	100
P37445	1-1/2"	45° Ell	100
P37490	1-1/2"	90° Ell	100

Chrome Plated PVC P-Trap



- Complete with nuts, washers, and escutcheon
- P36103 includes reducing washer

PART NO.	SIZE	CTN QTY
P36102	1-1/4"	1
P36103	1-1/2"	1

Polished Brass PVC P-Traps



- Slip joint
- Box escutcheon

PART NO.	SIZE	CTN QTY
P36100	1-1/4"	1
P36101	1-1/2"	1

ABS P-Trap



PART NO.	SIZE	CTN QTY
P39001	1-1/4"	100
P39002	1-1/2"	50

ABS P-Trap w/Adapter



PART NO.	SIZE	CTN QTY
P39003	1-1/2" slip joint	50
P39032	1-1/2" solvent weld	50

ABS Slip-Joint Center Outlet



PART NO.	SIZE	CTN QTY
P39004	1-1/2"	40

ABS Direct Connection Center Outlet Waste



PART NO.	SIZE	CTN QTY
P39005	1-1/2"	40

ABS Slip-Joint Center Outlet



PART NO.	SIZE	CTN QTY
P39006	1-1/2"	100

ABS Slip-Joint End Outlet Waste



PART NO.	SIZE	CTN QTY
P39007	1-1/2" x 16"	40
P39034	1-1/2" x 16" adjustable	40

ABS Direct Connection End Outlet Waste



PART NO.	SIZE	CTN QTY
P39008	1-1/2"	40

ABS Slip Joint End Outlet Tee Only



PART NO.	SIZE	CTN QTY
P39009	1-1/2"	100

ABS S-Trap



PART NO.	SIZE	CTN QTY
P39010	1-1/4"	60
P39011	1-1/2"	60

ABS Slip Joint Dishwasher Tailpiece



PART NO.	SIZE	CTN QTY
P39012	1-1/2" x 8" x 1/2"	25
P39030	1-1/2" x 8" x 3/4"	25

ABS Direct Connection Dishwasher Tailpiece



PART NO.	SIZE	CTN QTY
P39013	1-1/2" x 8" x 1/2"	25
P39031	1-1/2" x 8" x 3/4"	25

ABS Repair Trap



PART NO.	SIZE	CTN QTY
P39014	1-1/2"	80

ABS Slip Joint J-Bend



PART NO.	SIZE	CTN QTY
P39015	1-1/2"	60

ABS Slip Joint Waste Arm



PART NO.	SIZE	CTN QTY
P39016	1-1/2" x 16"	100

ABS Direct Connection Waste Arm



PART NO.	SIZE	CTN QTY
P39017	1-1/2" x 16"	100

ABS Slip Joint Extension Tube



PART NO.	SIZE	CTN QTY
P39018	1-1/2" x 16"	50

ABS Double Flange Extension



PART NO.	SIZE	CTN QTY
P39019	1-1/2" x 16"	100

ABS Slip Joint Extension Tube



PART NO.	SIZE	CTN QTY
P39020	1-1/4" x 6"	100
P39021	1-1/2" x 8"	100
P39022	1-1/2" x 12"	100

1-1/2" ABS Direct Connection Disposer Kit



- Poly washer and wing nuts
- Disposer washer
- 6" Tailpiece

PART NO.	SIZE	CTN QTY
P39033	1-1/2" x 16"	50

1-1/2" ABS Direct Connection Disposer Kit w/Adjustable Arm



- Baffle tee
- 6" Tailpiece
- Disposer washer
- Poly washers and wing nuts
- Telescoping arm adjusts up to 16"

PART NO.	SIZE	CTN QTY
P39035	1-1/2" x 16"	40

ABS Universal End Outlet Waste w/Dishwasher Connection



- 1-1/2" tubular; 16" maximum adjustment
- Slip joint or direct connection
- Baffle tee

PART NO.	SIZE	CTN QTY
P39040	1/2" branch	60
P39041	3/4" branch	60

ABS Solvent Extension Tube

PART NO.	SIZE	CTN QTY
P39023	1-1/4" x 8"	100
P39024	1-1/2" x 6"	100
P39025	1-1/2" x 12"	100

ABS Flanged Tailpiece

PART NO.	SIZE	CTN QTY
P39026	1-1/2" x 6"	200
P39027	1-1/2" x 8"	200
P39028	1-1/2" x 12"	200
P39029	1-1/2" x 16"	100

Chrome Plated ABS P-Trap

- Slip joint connection
- Box pattern escutcheon

PART NO.	SIZE	CTN QTY
P36104	1-1/4"	1
P36105	1-1/2"	1

PVC & ABS Tubular Bath Waste Kits

- Heavy walled PVC and ABS tubular
- Available in polished chrome and pvd protected polished brass and satin nickel
- 2-hole face plates with wrap-around gaskets and tapped holes
- 1-1/2" IPS threaded drain shoe
- Overflow elbow designed to accommodate B07-202 test kit
- Wing nuts and poly washers
- Come packaged in individual box
- UPC listed

1-1/2" Lift And Turn Bath Waste Tubular Kit



PART NO.	FINISH	FACE PLATE	MATERIAL	CTN	QTY
P37500	CP	2-hole	PVC	20	
P39500	CP	2-hole	ABS	20	
P37501	PB	2-hole	PVC	20	
P39501	PB	2-hole	ABS	20	
P37502	SN	2-hole	PVC	20	
P39502	SN	2-hole	ABS	20	

1-1/2" Brass Friction Lift Bath Waste Tubular Kit



PART NO.	FINISH	FACE PLATE	MATERIAL	CTN	QTY
P37503	CP	2-hole	PVC	20	
P39503	CP	2-hole	ABS	20	
P37504	PB	2-hole	PVC	20	
P39504	PB	2-hole	ABS	20	
P37505	SN	2-hole	PVC	20	
P39505	SN	2-hole	ABS	20	

1-1/2" Brass Toe Touch Bath Waste Tubular Kit



PART NO.	FINISH	FACE PLATE	MATERIAL	CTN	QTY
P37506	CP	2-hole	PVC	20	
P39506	CP	2-hole	ABS	20	
P37507	PB	2-hole	PVC	20	
P39507	PB	2-hole	ABS	20	
P37508	SN	2-hole	PVC	20	
P39508	SN	2-hole	ABS	20	

1-1/2" Trip Lever Bath Waste Tubular Kit



PART NO.	FINISH	FACE PLATE	MATERIAL	CTN	QTY
P37509	CP	2-hole	PVC	20	
P39509	CP	2-hole	ABS	20	
P37510	PB	2-hole	PVC	20	
P39510	PB	2-hole	ABS	20	
P37511	SN	2-hole	PVC	20	
P39511	SN	2-hole	ABS	20	

PVC & ABS Tubular Cable Drive Bath Waste 1/2 Kits

- Available in polished chrome and pvd protected polished brass and satin nickel
- 1-1/2" IPS threaded drain shoe
- UPC listed

1-1/2"- 27" Cable Drive



PART NO.	FINISH	MATERIAL	CTN	QTY
P37512	CP	PVC	20	
P39512	CP	ABS	20	
P37513	PB	PVC	20	
P39513	PB	ABS	20	
P37514	SN	PVC	20	
P39514	SN	ABS	20	

1-1/2"- 35" Cable Drive



PART NO.	FINISH	MATERIAL	CTN	QTY
P37515	CP	PVC	20	
P39515	CP	ABS	20	
P37516	PB	PVC	20	
P39516	PB	ABS	20	
P37517	SN	PVC	20	
P39517	SN	ABS	20	

1-1/2"- 45" Cable Drive



PART NO.	FINISH	MATERIAL	CTN	QTY
P37518	CP	PVC	20	
P39518	CP	ABS	20	
P37519	PB	PVC	20	
P39519	PB	ABS	20	
P37520	SN	PVC	20	
P39520	SN	ABS	20	

Commercial Lav Drain



- Polished chrome plated brass
- 17 Gauge 1-1/4" tailpiece; 6" long
- Mack washer and brass locknut

PART NO.	SIZE	CTN QTY
D70100	1-1/4"	25

Polished Brass Pop-Up Assembly



- PVD durable finish
- Tool free locknut and ballrod nut
- All metal construction
- 1-1/4" Tubular
- Boxed

PART NO.	DESCRIPTION	CTN QTY
P35002	PB pop-up assembly	10

Handicap Style Lav Drain



- Polished chrome plated brass
- Twin 90° construction
- 17 Gauge 1-1/4" tailpiece; cast brass elbows
- Mack washer and brass locknut

PART NO.	SIZE	CTN QTY
D70101	1-1/4"	1

ABS Pop Up Assembly



- Carded

PART NO.	DESCRIPTION	CTN QTY
P35004	Grey plastic	1

Commercial Handicap Drain w/Elbow



- Polished chrome plated brass; cast brass elbow
- Complete with gaskets and brass locknuts
- 1-1/4" Female thread

PART NO.	SIZE	CTN QTY
D70102	1-1/4"	1

Chrome Plated ABS Pop Up Assembly



- Carded

PART NO.	DESCRIPTION	CTN QTY
P35005	Chrome plated plastic	1

Chrome Plated Brass Pop-Up Assembly



- All metal construction
- Tool free locknut and ballrod nut
- Boxed

PART NO.	DESCRIPTION	CTN QTY
P35001	CP pop-up assembly	25

Brass P.O. Plug Drain



- With chain and stopper

PART NO.	SIZE	CTN QTY
D70103	1-1/4"	1

Trap Primer Tailpiece



- 17 Gauge tubular chrome plated steel
- Sturdy one-piece construction eliminates leaks and cross-threading

PART NO.	SIZE	CTN QTY
T74010	1-1/4" x 8" threaded top	1
T74011	1-1/2" x 8" direct connection	1

Plastic Slip Joint Nut



- White
- CARTON QUANTITIES ONLY

PART NO.	SIZE	CTN QTY
T83150	1-1/2" with wings	100
T85125	1-1/4" x 1-1/4"	100
T85150	1-1/2" x 1-1/2"	100

Plastic Slip Nut



- Replace fractured or stripped slip nuts without tubular disassembly
- Supplied with washer

PART NO.	SIZE	CTN QTY
T82125	1-1/4" Split nut	100
T82150	1-1/2" Split nut	100

Die Cast Zinc Slip Joint Nut



- Chrome plated
- CARTON QUANTITIES ONLY

PART NO.	IPS x SLIP TUBE	CTN QTY
T77125	1-1/4" x 1-1/4"	25
T77138	1-1/2" x 1-3/8"	25
T77150	1-1/2" x 1-1/2"	25
T77151	1-1/2" x 1-1/4"	25
T77152	2" x 1-1/2"	25
T77200	2" x 2"	25

Chrome Plated Brass Slip Joint Nut



- Chrome plated
- CARTON QUANTITIES ONLY

PART NO.	IPS x SLIP TUBE	CTN QTY
T78125	1-1/4" x 1-1/4"	25
T78150	1-1/2" x 1-1/2"	25
T78151	1-1/2" x 1-1/4"	25
T78152	2" x 1-1/2"	25
T78200	2" x 2"	25

Rough Brass Slip Joint Nut



- Heavy cast brass
- CARTON QUANTITIES ONLY

PART NO.	IPS x SLIP TUBE	CTN QTY
T84125	1-1/4" x 1-1/4"	25
T84150	1-1/2" x 1-1/2"	25
T84151	1-1/2" x 1-1/4"	25
T84200	2" x 2"	25

Die Cast Slip Joint Nut & Washer



- Chrome plated nut packed with square cut rubber washer
- CARTON QUANTITIES ONLY

PART NO.	SIZE	CTN QTY
T77014	1-1/4" x 1-1/4"	25
T77012	1-1/2" x 1-1/2"	25
T77013	1-1/2" x 1-1/4"	25
T77020	2" x 2"	25

Brass Slip Joint Nut & Washer



- Chrome plated nut packed with square cut rubber washer
- CARTON QUANTITIES ONLY

PART NO.	SIZE	CTN QTY
T78014	1-1/4" x 1-1/4"	25
T78012	1-1/2" x 1-1/2"	25
T78013	1-1/2" x 1-1/4"	25
T78020	2" x 2"	25

Square Cut Rubber Slip Joint Washer



• CARTON QUANTITIES ONLY

PART NO.	NUT x TUBE	CTN QTY
T79125	1-1/4" x 1-1/4"	100
T79150	1-1/2" x 1-1/2"	100
T79151	1-1/2" x 1-1/4"	100
T79200	2" x 2"	100
T79201	2" x 1-1/2"	100
T79152	1-1/2" x 1-1/4" cloth inserted	100

Poly Beveled Slip Joint Washer



• CARTON QUANTITIES ONLY

PART NO.	NUT x TUBE	CTN QTY
T80125	1-1/4" x 1-1/4"	100
T80150	1-1/2" x 1-1/2"	100
T80151	1-1/2" x 1-1/4"	100
T80200	2" x 2"	100

Flanged Poly Tailpiece Washer



• CARTON QUANTITIES ONLY

PART NO.	NUT x TUBE	CTN QTY
T81150	1-1/2" x 1-1/2"	100
T79152	1-1/2" x 1-1/4" cloth inserted	100

Marvel Rings



• Use on closet/urinal stub out adapter

PART NO.	FSWT x MIP	CTN QTY
B55004	1-1/4" SJ x 1-1/4" SWT	5
B55005	1-1/2" SJ x 1-1/2" SWT	5
B55006	2" SJ x 2" SWT	5
B55007	1-1/2" SJ x 1-1/4" SWT	5

PVC Marvel Adapter



• Thread x Hub

PART NO.	SIZE	CTN QTY
P37000	1-1/2" PVC	100
P39000	1-1/2" ABS	100

Tray Plug



- Stainless steel body with die cast locknut
- Fits 1-1/2" bar sink
- Complete with washers and stopper

PART NO.	DESCRIPTION	CTN QTY
B02051	Tray Plug	1

FIP x SLIP Waste Connector



- Brass body ferrule and nut; OD is copper tubular dimension
- MIP units are combination female sweat

PART NO.	FIP x OD	CTN QTY
T75125	1-1/4" x 1-1/4"	10
T75150	1-1/2" x 1-1/2"	10
T75151	1-1/2" x 1-1/4"	10

MIP x SLIP Waste Connector



- Brass body ferrule and nut; OD is copper tubular dimension
- MIP units are combination female sweat

PART NO.	MIP x OD	CTN QTY
T76125	1-1/4" x 1-1/4"	10
T76150	1-1/2" x 1-1/2"	10
T76151	1-1/2" x 1-1/4"	10

Flexible Trap Drain Connector



PART NO.	DESCRIPTION	CTN QTY
T06001	Connects 1-1/4"- 1-1/2" tubular to 1-1/4"- 1-1/2" tubular	20
T06002	Connects 1" DWV or 1-1/2" CTS to 1-1/4"- 1-1/2" tubular	20
T06003	Connects 1-1/2" DWV or CTS to 1-1/4"- 1-1/2" tubular	20
T06004	Connects 2" DWV to 1-1/4"- 1-1/2" tubular	20

Duo Basket Strainer



- 4-1/2" diameter to fit 3-1/2" drilling
- All stainless steel with zinc locknut
- Basket with rolled edge

PART NO.	DESCRIPTION	CTN QTY
S14001	SS Duo Basket Strainer	20

Snap Lock Basket Strainer



- 4-1/2" diameter to fit 3-1/2" drilling
- All stainless steel with zinc locknut
- Ball bearing basket with rolled edge (less tailpiece)

PART NO.	DESCRIPTION	CTN QTY
S14005	Snap lock basket strainer	20

Flat Top Grid Strainer



- 4-1/2" diameter to fit 3-1/2" drilling
- All stainless steel with zinc locknut (less tailpiece)

PART NO.	DESCRIPTION	CTN QTY
S14002	Flat top grid strainer	20

Shallow Cup Duo Basket Strainer



- 4-1/2" diameter to fit 3-1/2" drilling
- All stainless steel with zinc locknut
- Basket with rolled edge (less tailpiece)

PART NO.	DESCRIPTION	CTN QTY
S14006	Shallow cup duo strainer	1

Twist & Lock Basket Strainer



- 4-1/2" diameter to fit 3-1/2" drilling
- Screw-in basket (less tailpiece)

PART NO.	DESCRIPTION	CTN QTY
S14003	Twist & lock basket strainer	20
S14103	Replacement basket	1

Stainless Steel Duo Basket Strainer



- Stainless steel body and basket
- Neoprene stopper
- Spring style snap-in basket

PART NO.	DESCRIPTION	CTN QTY
S14606	SS duo basket strainer	50

Stainless Steel Duo Post Style Basket Strainer



- Stainless steel body and basket
- Polished inner cup
- Compare to JB250SS
- CP zinc post and slip nut
- Heavy duty rubber gasket and zinc locknut

PART NO.	DESCRIPTION	CTN QTY
S14251	SS Duo post style basket strainer	50
S14251T	SS Duo w/4" tailpiece	50

CP Brass Duo Strainer



- Beveled stopper w/o-ring seal
- Brass slip joint nut and lock nut
- Compare to Kohler K8801

PART NO.	DESCRIPTION	CTN QTY
S14007	CP brass duo strainer	20

Deep Cup Basket Strainer



- 4-1/2" diameter to fit 3-1/2" drilling
- All stainless steel with zinc locknut
- Basket with rolled edge (less tailpiece)

PART NO.	DESCRIPTION	CTN QTY
S14004	Deep cup basket strainer	20

Chrome Plated Brass Duo Basket Strainer



- Chrome plated brass body with stainless steel basket
- Heavy duty construction
- Neoprene stopper

PART NO.	DESCRIPTION	CTN QTY
S14250	CP brass duo basket strainer	50

Quick Fit Stainless Steel Basket Strainer



- Minimizes installation time
- Triangle frame mounts to underside
- Fits virtually all sinks
- Durable stainless construction with brass nut
- For replacement basket use B03015

PART NO.	DESCRIPTION	CTN QTY
S14008	SS basket strainer	1

Stainless Steel Deep Cup Basket Strainer



- Stainless steel body and basket
- Neoprene stopper
- Spring style snap-in basket

PART NO.	DESCRIPTION	CTN QTY
S14014	SS cup basket strainer	50
S14014T	Deep cup strainer w/tailpiece	50

Junior Duo Basket Strainer



- Stainless Steel body and basket with die cast locknut; 1-1/2" threads
- Complete with washers
- Fits 1-3/4" bar sink

PART NO.	DESCRIPTION	CTN QTY
B02050	Junior duo strainer	1
B02049	Replacement basket	1

Flat Duplex Strainer



- Stainless steel body and strainer with die cast locknut
- Complete with washers
- Fits 1-1/2" bar sink

PART NO.	DESCRIPTION	CTN QTY
B02052	Flat duplex strainer	1

Deep Junior Duo Basket Strainer



- For 2" and 2-1/2" deep outlets and bar sinks

PART NO.	DESCRIPTION	CTN QTY
B02102	2" Deep basket strainer	1
B02103	Replacement basket	1

Economy Replacement Basket Strainer



- ABS post
- Stainless steel basket

PART NO.	DESCRIPTION	CTN QTY
B03015	Replacement basket strainer	1

Fit-All Basket Strainer



- Stainless steel

PART NO.	DESCRIPTION	CTN QTY
B03010	Fit-all strainer	1

Snap N Lock Stainless Steel Basket Strainer



- Brass slip joint and lock nuts

PART NO.	DESCRIPTION	CTN QTY
S14010	Snap N Lock Stainless Steel Basket Strainer	1

Low Pattern-Tubular Sure Grip Escutcheons



- Chrome plated steel
- Carton quantities only

PART NO.	SIZE	FLANGE OD	CTN QTY
E03125	1-1/4" Tubular	2-7/8"	25
E03150	1-1/2" Tubular	2-7/8"	25
E03200	2" Tubular	3-1/2"	25

Box Pattern-Tubular Sure Grip Escutcheons



- Chrome plated steel
- Carton quantities only

PART NO.	SIZE	FLANGE OD	CTN QTY
E04125	1-1/4" Tubular	3"	5
E04150	1-1/2" Tubular	3"	5
E04200	2" Tubular	3"	5

Trap Covers



S04503



S04504



S04505



S04506



S04507



S04508

- Meets all specs of ADA Mandate
- Protects against scrapes & burns
- Provides excellent impact protection
- Fits 1-1/4" & 1-1/2" tubular & cast brass pipe
- Also fits plastic pipe & NY/LA cast brass trap
- S04507 thru S04510 meets ASTM E84-01

PART NO.	PLUMBEREX PART NO.	DESCRIPTION	CTN QTY
S04500	X4333	Trap & 2 stops	1
S04501	X4222	Trap & stop cover	1
S04502	X4444	Trap, 2 stops & 1 offset	1
S04503	X4111	Trap cover	1
S04504	X4112	Stop cover	1
S04505	X4114	Offset drain cover	1
S04506	X4116	Continuous waste cover	1
S04507	307	Velcro p-trap cover	1
S04508	327	Velcro angle stop valve & supply cover	1
S04509	396	Velcro p-trap & 2 valve & supply cover	1
S04510	427	Velcro p-trap & 2 valve & supply cover	1

B	
Basket Strainer.....	20, 21
Bath Waste 1/2 Kits	16
Bath Waste Kits	16
C	
Center Outlet.....	13
Center Outlet Tee.....	5
Center Outlet Waste.....	6, 13
Closet Flush Elbow.....	7
D	
Dishwasher Tailpiece	13, 14
Disposer Kit.....	7, 14
Disposer Kit w/1 3" Arm.....	12
Disposer Kit w/Adjustable Arm.....	12, 14
Double Flange Extension.....	14
Double Offset.....	6
Double Slip Fittings.....	8, 12
E	
End Outlet Tee Only.....	5, 13
End Outlet Waste.....	5, 13
Escutcheons.....	22
Extension Tube.....	7, 8, 9, 12, 14
F	
Flanged Tailpiece.....	9, 12, 15
Flexible Trap Drain Connector.....	19
G	
Grid Strainer.....	20
J	
J-Bend.....	4, 14
J-Bend w/Cleanout.....	4
M	
Marvel Adapter.....	19
Marvel Rings.....	19
Milwaukee Style Trap.....	5
P	
P-Trap.....	5, 9, 12, 13, 15
P-Trap w/Adapter.....	13
Rough Brass P-Trap.....	9
P-Traps.....	3
R	
Repair Trap.....	14
Repair Traps.....	5
S	
Sink Trap.....	4, 5
L.A. Pattern Sink Trap.....	4
Sink Trap w/ABS Adapter.....	4
Sink Trap w/Sweat Connection.....	4
Slip Joint Nut.....	18
Slip Joint Nut & Washer.....	18
Slip Nut.....	18
Solvent Extension Tube.....	15
S-Trap.....	13
S-Traps.....	4
T	
Tailpiece.....	6
Brass Direct Connect Dishwasher Tailpiece.....	6
Brass Double Flange Tailpiece.....	6
Brass Sink Tailpiece.....	6
Slip Joint Tailpiece.....	7
Slip Joint Tailpiece w/1/2" Sweat Branch.....	9
Threaded Connection Dishwasher Tailpiece.....	7
Trap Primer Tailpiece.....	18
Tee.....	8, 12
Trap Covers.....	22
Tray Plug.....	19
W	
Wall Bend.....	6
Washer.....	19
Beveled Slip Joint Washer.....	19
Flanged Poly Tailpiece Washer.....	19
Rubber Slip Joint Washer.....	19
Waste Arm.....	6, 8, 9, 14
Waste Connector.....	19
Waste w/Dishwasher Connection.....	14

PART NO.	PG #
B02049	19
B02050	19
B02051	17
B02052	19
B02102	19
B02103	19
B03010	19
B03015	19
B55004	17
B55005	17
B55006	17
B55007	17
C74105	6
D70100	15
D70101	15
D70102	15
D70103	15
E03125	20
E03150	20
E03200	20
E04125	20
E04150	20
E04200	20
J37124	1
J37150	1
P35001	15
P35002	15
P35004	15
P35005	15
P36100	10
P36101	10
P36102	10
P36103	10
P36104	13
P36105	13
P37000	17
P37001	8
P37002	8
P37003	8
P37004	8

PART NO.	PG #
P37005	8
P37006	8
P37007	8
P37008	8
P37009	8
P37010	9
P37011	9
P37012	9
P37013	9
P37014	9
P37015	9
P37016	9
P37017	9
P37018	9
P37019	9
P37020	10
P37021	10
P37022	10
P37023	10
P37024	10
P37025	10
P37026	10
P37027	10
P37028	10
P37029	10
P37030	9
P37031	9
P37032	8
P37033	10
P37034	8
P37035	10
P37036	8
P37037	9
P37038	10
P37040	9
P37041	9
P37042	8
P37118	9
P37200	10
P37400	10

PART NO.	PG #
P37445	10
P37490	10
P37500	14
P37501	14
P37502	14
P37503	14
P37504	14
P37505	14
P37506	14
P37507	14
P37508	14
P37509	14
P37510	14
P37511	14
P37512	14
P37513	14
P37514	14
P37515	14
P37516	14
P37517	14
P37518	14
P37519	14
P37520	14
P38001	1
P38002	1
P38002B	1
P38003	1
P38003B	1
P38004	1
P38005	1
P38005B	1
P38006	1
P38006B	1
P38007	1
P38008	1
P38009	1
P38009B (box esc.)	1
P38010	1
P38010B	1

PART NO.	PG #
P38011	1
P38012	1
P38012B	1
P38013	2
P38014	2
P38015	2
P38016	2
P38017	2
P38018	2
P38019	2
P38020	2
P38021	2
P38022	2
P38023	3
P38024	3
P38025	3
P38026	3
P38027	3
P38028	3
P38029	3
P38030	3
P38031	3
P38032	4
P38033	4
P38034	4
P38035	4
P38036	4
P38037	4
P38038	4
P38039	4
P38040	4
P38041	4
P38042	4
P38043	4
P38044	4
P38045	4
P38046	4
P38047	4
P38048	4
P38049	4

PART NO.	PG #	PART NO.	PG #	PART NO.	PG #	PART NO.	PG #
P38050	4	P38091	1	P38131	6	P39005	11
P38051	4	P38092	1	P38132	6	P39006	11
P38052	4	P38093	1	P38133	6	P39007	11
P38053	4	P38094	1	P38134	6	P39008	11
P38054	4	P38095	2	P38135	6	P39009	11
P38055	4	P38096	2	P38136	6	P39010	11
P38056	4	P38097	2	P38137	2	P39011	11
P38057	4	P38098	2	P38138	1	P39012	11
P38058	4	P38099	2	P38139	6	P39013	12
P38059	4	P38100	2	P38140	2	P39014	12
P38060	4	P38101	3	P38141	2	P39015	12
P38061	4	P38102	3	P38142	1	P39016	12
P38062	5	P38103	3	P38143	5	P39017	12
P38063	4	P38104	3	P38148	4	P39018	12
P38064	4	P38105	3	P38150	3	P39019	12
P38065	5	P38106	3	P38162	5	P39020	12
P38066	5	P38107	2	P38163	4	P39021	12
P38067	5	P38108	2	P38164	5	P39022	12
P38068	5	P38109	2	P38165	5	P39023	13
P38069	5	P38110	2	P38166	5	P39024	13
P38070	5	P38111	2	P38217	4	P39025	13
P38071	5	P38112	2	P38238	4	P39026	13
P38072	6	P38113	2	P38257	5	P39027	13
P38073	6	P38114	2	P38406	7	P39028	13
P38074	6	P38115	4	P38420	7	P39029	13
P38075	6	P38116	4	P38428	7	P39030	11
P38076	6	P38117	4	P38443	7	P39031	12
P38077	6	P38118	5	P38444	7	P39032	11
P38078	6	P38119	5	P38447	7	P39033	12
P38079	6	P38120	5	P38454	7	P39034	11
P38080	6	P38121	5	P38458	7	P39035	12
P38081	6	P38122	5	P38459	7	P39040	12
P38082	6	P38123	5	P38460	7	P39041	12
P38083	6	P38124	5	P38486	7	P39500	14
P38084	6	P38125	5	P38489	7	P39501	14
P38085	6	P38126	5	P39000	17	P39502	14
P38086	6	P38127	5	P39001	11	P39503	14
P38087	6	P38128	5	P39002	11	P39504	14
P38088	6	P38129	3	P39003	11	P39505	14
P38089	6	P38130	3	P39004	11	P39506	14

PART NO.	PG #
P39507	14
P39508	14
P39509	14
P39510	14
P39511	14
P39512	14
P39513	14
P39514	14
P39515	14
P39516	14
P39517	14
P39518	14
P39519	14
P39520	14
S04500	20
S04501	20
S04502	20
S04503	20
S04504	20
S04505	20
S04506	20
S04507	20
S04508	20
S04509	20
S04510	20
S14001	18
S14002	18
S14003	18
S14004	18
S14005	18
S14006	18
S14007	18
S14008	19
S14010	19
S14014	19
S14014T	19
S14103	18
S14250	18
S14251	18
S14251T	18

PART NO.	PG #
S14606	18
T06001	17
T06002	17
T06003	17
T06004	17
T74001	6
T74002	6
T74003	6
T74004	6
T74005	6
T74006	6
T74010	16
T74011	16
T75125	17
T75150	17
T75151	17
T76125	17
T76150	17
T76151	17
T77012	16
T77013	16
T77014	16
T77020	16
T77125	16
T77138	16
T77150	16
T77151	16
T77152	16
T77200	16
T78012	16
T78013	16
T78014	16
T78020	16
T78125	16
T78150	16
T78151	16
T78152	16
T78200	16
T79125	17
T79150	17

PART NO.	PG #
T79151	17
T79152	17
T79200	17
T79201	17
T80125	17
T80150	17
T80151	17
T80200	17
T81150	17
T82125	16
T82150	16
T83150	16
T84125	16
T84150	16
T84151	16
T84200	16
T85125	16
T85150	16



PVC DWV FITTINGS

VOLUME V



Quality
Products *for*
the Plumbing
Professional

Coupling

H x H



• Used to join straight lengths of pipe

PVC#	SIZE	MASTER CTN.
PFC114	1-1/4"	100
PFC115	1-1/2"	100
PFC120	2"	100
PFC130	3"	60
PFC140	4"	25
PFC160	6"	15

Repair Coupling

H x H



• Furnished without center stop so that stationary lengths of pipe can be spliced together

PVC#	SIZE	MASTER CTN.
PFC116	1-1/2"	25
PFC122	2"	25
PFC133	3"	10
PFC144	4"	5

Reducer Coupling

H x H



• Used to reduce or increase pipe sizes

PVC#	SIZE	MASTER CTN.
PFC121	2" x 1-1/2"	25
PFC131	3" x 1-1/2"	25
PFC132	3" x 2"	20
PFC142	4" x 2"	10
PFC143	4" x 3"	20

Flush Bushing

Spg x H



• Inserts into fitting hub to reduce to smaller pipe sizes

PVC#	SIZE	MASTER CTN.
PFB211	1-1/2" x 1-1/4"	50
PFB221	2" x 1-1/2"	100
PFB224	2" x 1-1/4"	70
PFB231	3" x 1-1/2"	20
PFB232	3" x 2"	30
PFB242	4" x 2"	30
PFB243	4" x 3"	30
PFB264	6" x 4"	10

Male Adapter

H x MPT



• Adapts to standard female pipe threads
• Teflon thread tape is recommended for threaded joints

PVC#	SIZE	MASTER CTN.
PMA414	1-1/4"	50
PMA415	1-1/2"	50
PMA420	2"	50
PMA430	3"	25
PMA440	4"	25

Female Adapter

H x FPT



• Adapts to standard male pipe threads
• Teflon thread tape is recommended for threaded joints

PVC#	SIZE	MASTER CTN.
PFA314	1-1/4"	100
PFA315	1-1/2"	100
PFA311	1-1/2" x 1-1/4"	100
PFA320	2"	100
PFA330	3"	30
PFA340	4"	10
PFA360	6"	10

Fitting C.O. Adapter, w/Plug

Spg x FPT



- Solvent welds into fitting hub to provide access to piping
- Teflon thread tape is recommended for threaded joints

PVC#	SIZE	MASTER CTN.
PFA615	1-1/2"	50
PFA620	2"	50
PFA630	3"	25
PFA640	4"	10

45 Deg Street Elbow

Spg x Hub



- Used to change direction from a fitting hub to a pipe
- Sometimes called a "St. 1/8 bend"

PVC#	SIZE	MASTER CTN.
PSL715S	1-1/2" short turn	100
PSL716S	1-1/2" long turn	100
PSL720	2"	50
PSL730	3"	20
PSL740	4"	10
PSL760	6"	3

60 Deg Elbow

H x H



- Used to change direction in piping
- Sometimes called a "OK bend"

PVC#	SIZE	MASTER CTN.
PFL915	1-1/2"	40
PFL920	2"	25
PFL930	3"	20
PFL940	4"	10

90 Deg Vent Elbow

H x H



- Used to change direction in the "dry" portion of vent piping where water flow is not a consideration

PVC#	SIZE	MASTER CTN.
PFL715	1-1/2"	20
PFL720	2"	30
PFL730	3"	10

90 Deg Elbow

H x H



- Used to change direction in piping
- Sometimes called a "1/4 bend"

PVC#	SIZE	MASTER CTN.
PFL814	1-1/4"	100
PFL815	1-1/2"	100
PFL820	2"	50
PFL830	3"	25
PFL840	4"	10
PFL860	6"	5
PFL821	2" x 1-1/2"	20
PFL834	4" x 3"	20

90 Deg Elbow w/Side Inlet

H x H x Spg/H



- Used to connect a branch line or vent at a change of direction in a larger vertical or horizontal pipe
- The inlet is constructed to accept a 2" fitting over its outside diameter or a 1-1/2" pipe into its inside diameter

PVC#	SIZE	MASTER CTN.
PFL131	3" x 2" Spg or 1-1/2" Hub	20

90 Deg Street Elbow

Spg x H



- Used to change direction in piping
- Sometimes called a "street 1/4 bend"

PVC#	SIZE	MASTER CTN.
PSL916	1-1/2"	100
PSL926	2"	50
PSL936	3"	20
PSL946	4"	10

90 Deg Long Sweep Elbow

H x H



- Used to change direction in piping
- Sometimes called a "long turn 1/4 bend"

PVC#	SIZE	MASTER CTN.
PFL815L	1-1/2"	50
PFL820L	2"	25
PFL830L	3"	10
PFL840L	4"	5

90 Deg Lowheel Inlet Elbow

H x H x Spg/H or H x H x H



- Used to connect a branch line or vent at a change of direction in a larger vertical or horizontal pipe
- The inlet is constructed to accept a 2" fitting over its outside diameter or a 1-1/2" pipe into its inside diameter

PVC#	SIZE	MASTER CTN.
PFL031	3" x 2" Spg or 1-1/2" Hub	25
PFL032	3" x 2" Hub	25

22 1/2 Deg Elbow

H x H



- Used to change direction in piping
- Sometimes called a "1/16 bend"

PVC#	SIZE	MASTER CTN.
PFL515	1-1/2"	50
PFL520	2"	25
PFL530	3"	20
PFL540	4"	15
PFL560	6"	3

Fitting C.O. Adapter

Spg x FPT



- Solvent welds into fitting hub and adapts to male threaded plug
- This fitting is a component part of "Fitting Cleanout w/ Threaded Plug"

PVC#	SIZE	MASTER CTN.
PFA614	1-1/2"	50
PFA619	2"	50
PFA629	3"	25
PFA639	4"	10
PFA659	6"	10

22 1/2 Deg Street Elbow

H x Spgt



- Used to change direction in piping
- Sometimes called a "St. 1/16 bend"

PVC#	SIZE	MASTER CTN.
PSL815	1-1/2"	50
PSL820	2"	25
PSL830	3"	20
PSL840	4"	10

Caps

Hub



- Used for permanently or temporarily capping pipe

PVC#	SIZE	MASTER CTN.
PHC151	1-1/2"	10
PHC152	2"	5
PHC153	3"	10
PHC154	4"	5

45 Deg Elbow

H x H



- Used to change direction in piping
- Sometimes cled a "1/8 bend"

PVC#	SIZE	MASTER CTN.
PFL614	1-1/4"	100
PFL615	1-1/2"	100
PFL620	2"	50
PFL630	3"	20
PFL640	4"	10
PFL660	6"	3
PFL615S	1-1/2" short turn	100
PFL620S	2" short turn	100

Double 90 Deg Elbow

H x H x H



- Ideal for “back to back” sink or lavatory installations

PVC#	SIZE	MASTER CTN.
PDL716	1-1/2"	20
PDL736	3"	10
PDL722	2" x 1-1/2" x 1-1/2"	25

Wye

H x H x H



- Used when connecting a branch line into a horizontal drain pipe
- Also used in conjunction with a “twist-lok” plug to provide a cleanout in a drain pipe

PVC#	SIZE	MASTER CTN.
PFY014	1-1/4"	35
PFY015	1-1/2"	50
PFY020	2"	25
PFY030	3"	25
PFY040	4"	5
PFY060	6"	4
PFY021	2" x 1-1/2"	25
PFY023	2" x 1-1/2" x 1-1/2"	25
PFY031	3" x 1-1/2"	15
PFY032	3" x 2"	25
PFY041	4" x 4" x 1-1/2"	10
PFY042	4" x 2"	10
PFY043	4" x 3"	10
PFY064	6" x 4"	5

Double Wye

All Hub



- Used to bring two branch lines into a horizontal drain pipe

PVC#	SIZE	MASTER CTN.
PDY415	1-1/2"	40
PDY420	2"	20
PDY430	3"	15
PDY440	4"	5
PDY442	4" x 4" x 2" x 2"	5
PDY443	4" x 4" x 3" x 3"	5

Double Fixture Tee

H x H x H x H



PVC#	SIZE	MASTER CTN.
PDT621	2" x 1-1/2" x 1-1/2" x 1-1/2"	20

Vent Tee

H x H x H



- Used primarily in seepage bed piping grids in conjunction with perforated pipe
- Used where flow characteristics are not a primary consideration

PVC#	SIZE	MASTER CTN.
PVT415	1-1/2"	10
PVT420	2"	10
PVT430	3"	10
PVT440	4"	10

Long Turn Tee Wye

H x H x H



- Used in some plumbing code areas to connect a branch line into a vertical drain pipe instead of a conventional tee fitting
- Also used to connect horizontal branch pipe approaching a horizontal drain pipe on the perpendicular

PVC#	SIZE	MASTER CTN.
PFY515L	1-1/2"	20
PFY520L	2"	10
PFY530L	3"	10
PFY540L	4"	5
PFY521	2" x 1-1/2"	20
PFY531	3" x 1-1/2"	10
PFY532	3" x 2"	10
PFY542	4" x 2"	10
PFY543	4" x 3"	5

Cleanout Test Tee

H x H x FPT



- Used in conjunction with a threaded plug to provide a cleanout opening
- Teflon thread tape is recommended for joints

PVC#	SIZE	MASTER CTN.
PCT416	1-1/2"	20
PCT421	2"	20
PCT431	3"	10
PCT441	4"	10

w/Cleanout Plug

- Used at the base of a vertical drain pipe to provide a cleanout opening flush with the finished wall

PVC#	SIZE	MASTER CTN.
PCT315	1-1/2"	10
PCT320	2"	10
PCT330	3"	10
PCT340	4"	5

Sanitary Tee

H x H x H



- Used when connecting a branch line into a vertical drain pipe

PVC#	SIZE	MASTER CTN.
PST114	1-1/4"	25
PST115	1-1/2"	100
PST120	2"	35
PST130	3"	30
PST140	4"	5
PST160	6"	6
PST121	2" x 1-1/2"	50
PST122	2" x 1-1/2" x 2"	25
PST123	2" x 1-1/2" x 1-1/2"	25
PST131	3" x 1-1/2"	20
PST132	3" x 2"	10
PST141	4" x 1-1/2"	10
PST142	4" x 2"	10
PST143	4" x 3"	10
PST164	6" x 4"	6

Sanitary Tee Street

Spg x H x H



PVC#	SIZE	MASTER CTN.
PSS140	4"	10

Sanitray Tee w/Right Side Inlet

H x H x H x H



- This fitting provides for the connection of 2" vent or branch waste piping to a vertical pipe

PVC#	SIZE	MASTER CTN.
PST232	3" x 3" x 3" x 2"	10

Sanitray Tee w/Left Side Inlet

H x H x H x H



- This fitting provides for the connection of 2" vent or branch waste piping to a vertical pipe

PVC#	SIZE	MASTER CTN.
PSL132	3" x 3" x 3" x 2"	10

Sanitray Tee w/Right & Left Side Inlet

H x H x Spg/H x Spg/H



Sanitray Tee w/Right & Left Side Inlet

- Provides for the connection of 1-1/2" or 2" vent or branch waste piping to a vertical pipe as well as receiving the discharge of a water closet
- the inlets are constructed to accept a 2" fitting hub over their outside diameter or a 1-1/2" pipe into their inside diameter

PVC#	SIZE	MASTER CTN.
PSL031	3" x 3" x 3" x 1-1/2" / 2" x 1-1/2" / 2"	10

Sanitray Tee w/Right & Left Side Inlet

- Provides for the connection of 2" vent or branch waste piping to a vertical pipe as well as receive the discharge of a water closet

PVC#	SIZE	MASTER CTN.
PSL042	4" x 4" x 4" x 2" x 2"	5

Double Sanitary Tee

H x H x H x H



• Used to bring two branch lines into a vertical drain pipe

PVC#	SIZE	MASTER CTN.
PDT515	1-1/2"	25
PDT520	2"	20
PDT530	3"	20
PDT540	4"	4
PDT521	2" x 2" x 1-1/2" x 1-1/2"	15
PDT531	3" x 3" x 1-1/2" x 1-1/2"	20
PDT532	3" x 3" x 2" x 2"	10
PDT542	4" x 4" x 2" x 2"	5
PDT543	4" x 4" x 3" x 3"	5

Two-Way Cleanout Tee

H x H x H



• Used with a vertical pipe stack, this fitting provides for above ground level access to piping

PVC#	SIZE	MASTER CTN.
PTC633	3"	10
PTC644	4"	5

P-Trap LA Pattern w/Union

SJ x H



• Used to prevent the passage of sewer gas from the plumbing system into house through the plumbing fixture drain, when local code doesn't permit the use of slip coupled traps

PVC#	SIZE	MASTER CTN.
PPT715	1-1/2"	20

P-Trap w/Union

H x H



• Used to prevent the passage of sewer gas from the plumbing system into house through the plumbing fixture drain

PVC#	SIZE	MASTER CTN.
PPT315	1-1/2"	20
PPT320	2"	25

P-Trap w/Solvent Weld Joint

H x H



• Used to prevent the passage of sewer gas from the plumbing system into house through the plumbing fixture drain

PVC#	SIZE	MASTER CTN.
PPT515	1-1/2"	25
PPT520	2"	20
PPT530	3"	10
PPT540	4"	4

P-Trap w/Cleanout & Solvent Weld Joint

H x H



• Used to prevent the passage of sewer gas from the plumbing system into house through the plumbing fixture drain

PVC#	SIZE	MASTER CTN.
PPT415	1-1/2"	10
PPT420	2"	10

P-Trap U-Bend

H x H



• Bottom part of trap furnished without cleanout

PVC#	SIZE	MASTER CTN.
PPT015	1-1/2"	20
PPT020	2"	20
PPT030	3"	15
PPT040	4"	10

P-Trap Ell

Spg x H Short Sweep



• Used to change direction in the "dry" portion of vent piping where water flow is not a consideration

PVC#	SIZE	MASTER CTN.
PPT915S	1-1/2"	100
PPT920S	2"	20

Swivel Drum Trap

H x H



- PVC version of the old style bathtub “drum trap”
- Largely replaced today by the conventional 1-1/2” P-trap

PVC#	SIZE	MASTER CTN.
PDT715	3” x 6” x 1-1/2”	15

Female Trap Adapter w/Self Sealing Nut

H x SJT



- Utilized to adapt PVC pipe to tubular traps at wall or floor
- Utilizes special washer which seals to either 1-1/2” or 1-1/4” tubular products, reducing the number of SKU’s needed in inventory
- This fitting solvent welds over a 1-1/2” DWV pipe
- Sometimes referred to as a “marvel”

PVC#	SIZE	MASTER CTN.
PTA215	1-1/2”	100
PTA221	1-1/2” x 1-1/2” or 1-1/4”	100
PTA223	1-1/2” x 1-1/2”	100

Male Trap Adapter less Washer & Nuts

Spg x MPT



- Adapts fitting hub to standard female pipe threads
- Teflon thread tape is recommended for threaded joints

PVC#	SIZE	MASTER CTN.
PTA415	1-1/2”	100
PTA420	2”	100

Male Trap Adapter w/Washer & Nuts

Spg x SJT



- Adapts PVC fitting hub to tubular traps in a wall or floor
- Utilizes special washer which seals to either 1-1/2” or 1-1/4” tubular products, reducing the number of SKU’s needed in inventory
- This fitting solvent welds into a 1-1/2” DWV fitting hub
- Sometimes called a “marvel”

PVC#	SIZE	MASTER CTN.
PTA315	1-1/2”	50
PTA311	1-1/2” x 1-1/2” or 1-1/4”	75
PTA211	1-1/2” x 1-1/2”	50

Reducing Closet Bend

Spg x Hub



- Used to change direction in piping and size of pipe directly into fitting hub
- Usually a closet flange directly under a toilet
- Works well in tight space applications on second floors

PVC#	SIZE	MASTER CTN.
PCB934	4” x 3”	20

Expansion Joint

H x H



- To provide for expansion in straight vertical pipe runs exceeding 35 feet in length

PVC#	SIZE	MASTER CTN.
PEJ520	2”	15
PEJ530	3”	10
PEJ540	4”	10

Cast Iron No Hub Adapter

Spg x H



- Adapts no hub elastomer coupling to DWV spigot
- Provides a proper method of adapting from no-hub cast iron pipe utilizing the standard no-hub clamp ring

PVC#	SIZE	MASTER CTN.
PNH120	2”	100
PNH130	3”	20
PNH140	4”	10

Cast Iron Hub Adapter

Spg x H



- Adapts cast iron hub to DWV Spigot
- Can be joined to cast iron with Genova plastic lead or hot molten lead

PVC#	SIZE	MASTER CTN.
PHA520	2”	25
PHA521	2” x 1-1/2”	20
PHA530	3”	20
PHA540	4”	10
PHA543	4” x 3”	20

Cast Iron Spigot Adapter

H x H



- Adapts cast iron spigot to DWV spigot
- This fitting adapts Sch. 40 pipe to 4" cast iron spigot

PVC#	SIZE	MASTER CTN.
PSA730	3"	10
PSA740	4"	10

Adapter Coupling

Sewer H x DWV H



- Adapts sewer & drain spigot to DWV spigot

PVC#	SIZE	MASTER CTN.
PAC543	4" x 3"	20

Adaper Bushing

DWV Spg x Sewer H



- Adapts DWV hub to sewer & drain spigot

PVC#	SIZE	MASTER CTN.
PAB75340	4"	25

Adapter Bushing

Sewer Spg x DWV H



- Adapts sewer & drain hub to DWV spigot

PVC#	SIZE	MASTER CTN.
PAB243	4" x 3"	20

A

Adapter Bushing 8

Adapter 1, 3, 7

 Female Adapter 1

 Fitting C.O. Adapter, w/Plug 2

 Male Adapter 1

 No Hub Adapter 7

 Spigot Adapter 8

Adapter Coupling 8

C

Caps 3

Cleanout Tee 6

Closet Bend 7

Coupling 1

E

Elbow 2, 3

Expansion Joint 7

F

Flush Bushing 1

L

Long Sweep Elbow 2

P

P-Trap 6

R

Reducer Coupling 1

Repair Coupling 1

S

Sanitary Tee 5

Sanitray Tee 5

Swivel Drum Trap 7

T

Tee 4, 5

Trap Adapter 7

V

Vent Elbow 2

W

Wye 4

PART NO.	PG #
PAB243	8
PAB75340	8
PAC543	8
PCB934	7
PCT315	5
PCT320	5
PCT330	5
PCT340	5
PCT416	5
PCT421	5
PCT431	5
PCT441	5
PDL716	4
PDL722	4
PDL736	4
PDT515	6
PDT520	6
PDT521	6
PDT530	6
PDT531	6
PDT532	6
PDT540	6
PDT542	6
PDT543	6
PDT621	4
PDT715	7
PDY415	4
PDY420	4
PDY430	4
PDY440	4
PDY442	4
PDY443	4
PEJ520	7
PEJ530	7
PEJ540	7
PFA311	1
PFA314	1
PFA315	1
PFA320	1
PFA330	1

PART NO.	PG #
PFA340	1
PFA360	1
PFA614	3
PFA615	2
PFA619	3
PFA620	2
PFA629	3
PFA630	2
PFA639	3
PFA640	2
PFA659	3
PFB211	1
PFB221	1
PFB224	1
PFB231	1
PFB232	1
PFB242	1
PFB243	1
PFB264	1
PFC114	1
PFC115	1
PFC116	1
PFC120	1
PFC121	1
PFC122	1
PFC130	1
PFC131	1
PFC132	1
PFC133	1
PFC140	1
PFC142	1
PFC143	1
PFC144	1
PFC160	1
PFL031	3
PFL032	3
PFL131	2
PFL515	3
PFL520	3
PFL530	3

PART NO.	PG #
PFL540	3
PFL560	3
PFL614	3
PFL615	3
PFL615S	3
PFL620	3
PFL620S	3
PFL630	3
PFL640	3
PFL660	3
PFL715	2
PFL720	2
PFL730	2
PFL814	2
PFL815	2
PFL815L	2
PFL820	2
PFL820L	2
PFL821	2
PFL830	2
PFL830L	2
PFL834	2
PFL840	2
PFL840L	2
PFL860	2
PFL915	2
PFL920	2
PFL930	2
PFL940	2
PFY014	4
PFY015	4
PFY020	4
PFY021	4
PFY023	4
PFY030	4
PFY031	4
PFY032	4
PFY040	4
PFY041	4
PFY042	4

PART NO.	PG #
PFY043	4
PFY060	4
PFY064	4
PFY515L	4
PFY520L	4
PFY521	4
PFY530L	4
PFY531	4
PFY532	4
PFY540L	4
PFY542	4
PFY543	4
PHA520	7
PHA521	7
PHA530	7
PHA540	7
PHA543	7
PHC151	3
PHC152	3
PHC153	3
PHC154	3
PMA414	1
PMA415	1
PMA420	1
PMA430	1
PMA440	1
PNH120	7
PNH130	7
PNH140	7
PPT015	6
PPT020	6
PPT030	6
PPT040	6
PPT315	6
PPT320	6
PPT415	6
PPT420	6
PPT515	6
PPT520	6
PPT530	6

PART NO.	PG #
PPT540	6
PPT715	6
PPT915S	6
PPT920S	6
PSA730	8
PSA740	8
PSL031	5
PSL042	5
PSL132	5
PSL715S	2
PSL716S	2
PSL720	2
PSL730	2
PSL740	2
PSL760	2
PSL815	3
PSL820	3
PSL830	3
PSL840	3
PSL916	2
PSL926	2
PSL936	2
PSL946	2
PSS140	5
PST114	5
PST115	5
PST120	5
PST121	5
PST122	5
PST123	5
PST130	5
PST131	5
PST132	5
PST140	5
PST141	5
PST142	5
PST143	5
PST160	5
PST164	5
PST232	5

PART NO.	PG #
PTA211	7
PTA215	7
PTA221	7
PTA223	7
PTA311	7
PTA315	7
PTA415	7
PTA420	7
PTC633	6
PTC644	6
PVT415	4
PVT420	4
PVT430	4
PVT440	4



BLACK & GALVANIZED MALLEABLES & PIPE NIPPLES

VOLUME V

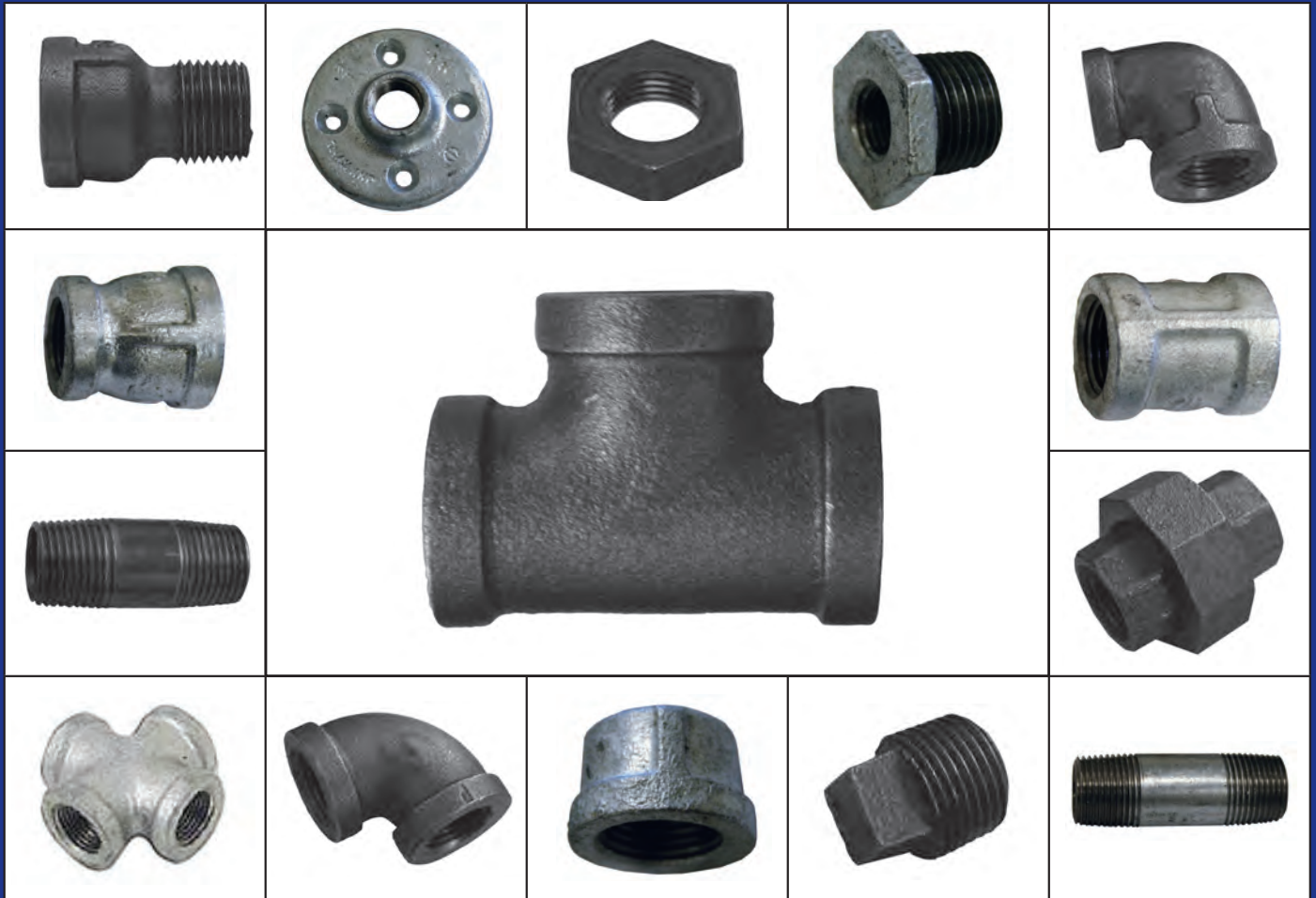

Quality
Products *for*
the Plumbing
Professional

Black & Galvanized Malleable Fittings 1-6

Black & Galvanized Pipe Nipples 7-9

Black & Galvanized Readycut Pipe 10

Black & Galvanized Merchant Couplings 11

Product Index..... 12

Part Number Index..... 13-18

Hexagon Bushings

M x F, Concentric



BLACK PRT #	GALV. PRT #	SIZE	CTN QTY	MSTR QTY
B144-0007	G144-0007	1/4" x 1/8"	120	1,440
B144-0032	G144-0032	3/8" x 1/4"	75	900
B144-0033	G144-0033	3/8" x 1/8"	75	900
B144-0058	G144-0058	1/2" x 3/8"	100	1,200
B144-0059	G144-0059	1/2" x 1/4"	100	1,200
B144-0060	G144-0060	1/2" x 1/8"	100	1,200
B144-0107	G144-0107	3/4" x 1/2"	50	600
B144-0108	G144-0108	3/4" x 3/8"	50	600
B144-0109	G144-0109	3/4" x 1/4"	50	600
B144-0110	G144-0110	3/4" x 1/8"	50	600
B144-0159	G144-0159	1" x 3/4"	50	400
B144-0160	G144-0160	1" x 1/2"	50	400
B144-0161	G144-0161	1" x 3/8"	50	400
B144-0162	G144-0162	1" x 1/4"	50	400
B144-0222	G144-0222	1-1/4" x 1"	30	240
B144-0223	G144-0223	1-1/4" x 3/4"	30	240
B144-0224	G144-0224	1-1/4" x 1/2"	30	240
B144-0225	G144-0225	1-1/4" x 3/8"	30	240
B144-0226	G144-0226	1-1/4" x 1/4"	30	240
B144-0303	G144-0303	1-1/2" x 1-1/4"	25	150
B144-0304	G144-0304	1-1/2" x 1"	25	150
B144-0305	G144-0305	1-1/2" x 3/4"	25	150
B144-0306	G144-0306	1-1/2" x 1/2"	25	150
B144-0307	G144-0307	1-1/2" x 3/8"	25	150
B144-0308	G144-0308	1-1/2" x 1/4"	25	150
B144-0398	G144-0398	2" x 1-1/2"	20	120
B144-0399	G144-0399	2" x 1-1/4"	20	120
B144-0400	G144-0400	2" x 1"	20	120
B144-0401	G144-0401	2" x 3/4"	20	120
B144-0402	G144-0402	2" x 1/2"	20	120
B144-0403	G144-0403	2" x 3/8"	20	120
B144-0531	G144-0531	2-1/2" x 2"	15	60
B144-0532	G144-0532	2-1/2" x 1-1/2"	15	60
B144-0533	G144-0533	2-1/2" x 1-1/4"	15	60
B144-0534	G144-0534	2-1/2" x 1"	15	60
B144-0535	G144-0535	2-1/2" x 3/4"	15	60
B144-0536	G144-0536	2-1/2" x 1/2"	15	60
B144-0662	G144-0662	3" x 2-1/2"	12	48
B144-0663	G144-0663	3" x 2"	12	48
B144-0664	G144-0664	3" x 1-1/2"	12	48
B144-0665	G144-0665	3" x 1-1/4"	12	48
B144-0666	G144-0666	3" x 1"	12	48
B144-0667	G144-0667	3" x 3/4"	12	48
B144-0668	G144-0668	3" x 1/2"	12	48
B144-0790	G144-0790	3-1/2" x 3"	8	32
B144-0870	G144-0870	4" x 3"	5	20
B144-0871	G144-0871	4" x 2-1/2"	5	20
B144-0872	G144-0872	4" x 2"	5	20

Hexagon Bushings continued

BLACK PRT #	GALV. PRT #	SIZE	CTN QTY	MSTR QTY
B144-0873	G144-0873	4" x 1-1/2"	5	20
B144-0874	G144-0874	4" x 1-1/4"	5	20
B144-0875	G144-0875	4" x 1"	5	20
B144-0876	G144-0876	4" x 3/4"	5	20
B144-1109	G144-1109	6" x 4"	4	8
B144-1111	G144-1111	6" x 3"	4	8

Cap



BLACK PRT #	GALV. PRT #	SIZE	CTN QTY	MSTR QTY
B155-0001	G155-0001	1/8"	120	1,440
B155-0002	G155-0002	1/4"	80	960
B155-0025	G155-0025	3/8"	60	720
B155-0050	G155-0050	1/2"	75	900
B155-0100	G155-0100	3/4"	40	480
B155-0150	G155-0150	1"	35	280
B155-0215	G155-0215	1-1/4"	25	200
B155-0295	G155-0295	1-1/2"	25	150
B155-0390	G155-0390	2"	18	108
B155-0520	G155-0520	2-1/2"	14	56
B155-0650	G155-0650	3"	12	36
B155-0860	G155-0860	4"	7	21
B155-0975	G155-0975	5"	8	16
B155-1100	G155-1100	6"	4	8

Extension Piece

M x F



BLACK PRT #	GALV. PRT #	SIZE	CTN QTY	MSTR QTY
B335-0050	G335-0050	1/2"	75	75
B335-0100	G335-0100	3/4"	40	320
B335-0150	G335-0150	1"	30	180
B335-0215	G335-0215	1-1/4"	30	120
B335-0295	G335-0295	1-1/2"	20	80
B335-0390	G335-0390	2"	15	60

Coupling, Banded

F x F



BLACK PRT #	GALV. PRT #	SIZE	CTN QTY	MSTR QTY
B165-0001	G165-0001	1/8"	70	840
B165-0002	G165-0002	1/4"	40	480
B165-0025	G165-0025	3/8"	50	600
B165-0050	G165-0050	1/2"	60	480
B165-0100	G165-0100	3/4"	50	300
B165-0150	G165-0150	1"	25	150
B165-0215	G165-0215	1-1/4"	32	128
B165-0295	G165-0295	1-1/2"	18	72
B165-0390	G165-0390	2"	12	48
B165-0520	G165-0520	2-1/2"	4	32
B165-0650	G165-0650	3"	12	24
B165-0860	G165-0860	4"	3	6
B165-1100	G165-1100	6"	3	6

Reducing Coupling, Banded

F x F, Concentric



BLACK PRT #	GALV. PRT #	SIZE	CTN QTY	MSTR QTY
B165-0007	G165-0007	1/4" x 1/8"	50	600
B165-0032	G165-0032	3/8" x 1/4"	30	360
B165-0033	G165-0033	3/8" x 1/8"	35	420
B165-0058	G165-0058	1/2" x 3/8"	40	480
B165-0059	G165-0059	1/2" x 1/4"	50	600
B165-0060	G165-0060	1/2" x 1/8"	50	600
B165-0107	G165-0107	3/4" x 1/2"	60	360
B165-0108	G165-0108	3/4" x 3/8"	30	360
B165-0109	G165-0109	3/4" x 1/4"	30	360
B165-0110	G165-0110	3/4" x 1/8"	35	0
B165-0159	G165-0159	1" x 3/4"	25	200
B165-0160	G165-0160	1" x 1/2"	40	240
B165-0161	G165-0161	1" x 3/8"	40	240
B165-0162	G165-0162	1" x 1/4"	45	220
B165-0222	G165-0222	1-1/4" x 1"	20	120
B165-0223	G165-0223	1-1/4" x 3/4"	25	150
B165-0224	G165-0224	1-1/4" x 1/2"	25	150
B165-0225	G165-0225	1-1/4" x 3/8"	25	150
B165-0303	G165-0303	1-1/2" x 1-1/4"	24	96
B165-0304	G165-0304	1-1/2" x 1"	25	100
B165-0305	G165-0305	1-1/2" x 3/4"	30	120
B165-0306	G165-0306	1-1/2" x 1/2"	20	120
B165-0307	G165-0307	1-1/2" x 3/8"	30	120
B165-0398	G165-0398	2" x 1-1/2"	12	72
B165-0399	G165-0399	2" x 1-1/4"	14	84
B165-0400	G165-0400	2" x 1"	14	84
B165-0401	G165-0401	2" x 3/4"	14	84
B165-0402	G165-0402	2" x 1/2"	14	84
B165-0531	G165-0531	2-1/2" x 2"	10	40
B165-0532	G165-0532	2-1/2" x 1-1/2"	10	40
B165-0533	G165-0533	2-1/2" x 1-1/4"	10	40
B165-0534	G165-0534	2-1/2" x 1"	10	40
B165-0535	G165-0535	2-1/2" x 3/4"	10	40
—	G165-0536	2-1/2" x 1/2"	10	40
B165-0662	G165-0662	3" x 2-1/2"	12	24
B165-0663	G165-0663	3" x 2"	8	32
B165-0664	G165-0664	3" x 1-1/2"	8	32
B165-0665	G165-0665	3" x 1-1/4"	8	32
B165-0666	G165-0666	3" x 1"	8	32
B165-0667	G165-0667	3" x 3/4"	8	32
B165-0668	G165-0668	3" x 1/2"	8	32
B165-0870	G165-0870	4" x 3"	6	18
B165-0871	G165-0871	4" x 2-1/2"	6	18
B165-0872	G165-0872	4" x 2"	6	18
B165-0873	G165-0873	4" x 1-1/2"	6	18
B165-0874	G165-0874	4" x 1-1/4"	6	18
B165-0875	G165-0875	4" x 1"	6	18
B165-1109	G165-1109	6" x 4"	4	8
B165-1111	G165-1111	6" x 3"	6	18

Cross, Banded

F x F x F x F



BLACK PRT #	GALV. PRT #	SIZE	CTN QTY	MSTR QTY
B195-0001	G195-0001	1/8"	30	360
B195-0002	G195-0002	1/4"	80	480
B195-0025	G195-0025	3/8"	50	300
B195-0050	G195-0050	1/2"	45	180
B195-0100	G195-0100	3/4"	30	120
B195-0150	G195-0150	1"	20	60
B195-0215	G195-0215	1-1/4"	20	40
B195-0295	G195-0295	1-1/2"	18	36
B195-0390	G195-0390	2"	10	20
B195-0520	G195-0520	2-1/2"	4	12
B195-0650	G195-0650	3"	4	8
B195-0860	G195-0860	4"	2	4

90 Deg Reducing Elbow, Banded

F x F



BLACK PRT #	GALV. PRT #	SIZE	CTN QTY	MSTR QTY
B235-0007	G235-0007	1/4" x 1/8"	—	—
B235-0032	G235-0032	3/8" x 1/4"	60	720
B235-0058	G235-0058	1/2" x 3/8"	50	400
B235-0059	G235-0059	1/2" x 1/4"	40	480
B235-0060	G235-0060	1/2" x 1/8"	40	480
B235-0107	G235-0107	3/4" x 1/2"	40	240
B235-0108	G235-0108	3/4" x 3/8"	50	300
B235-0109	G235-0109	3/4" x 1/4"	40	320
B235-0159	G235-0159	1" x 3/4"	25	150
B235-0160	G235-0160	1" x 1/2"	30	180
B235-0161	G235-0161	1" x 3/8"	35	210
B235-0222	G235-0222	1-1/4" x 1"	20	80
B235-0223	G235-0223	1-1/4" x 3/4"	30	120
B235-0224	G235-0224	1-1/4" x 1/2"	35	140
B235-0303	G235-0303	1-1/2" x 1-1/4"	15	60
B235-0304	G235-0304	1-1/2" x 1"	20	80
B235-0305	G235-0305	1-1/2" x 3/4"	15	90
B235-0306	G235-0306	1-1/2" x 1/2"	25	100
B235-0398	G235-0398	2" x 1-1/2"	10	40
B235-0399	G235-0399	2" x 1-1/4"	10	40
B235-0400	G235-0400	2" x 1"	14	56
B235-0401	G235-0401	2" x 3/4"	15	60
B235-0402	G235-0402	2" x 1/2"	15	60
B235-0531	G235-0531	2-1/2" x 2"	12	24
B235-0532	G235-0532	2-1/2" x 1-1/2"	6	24
B235-0533	G235-0533	2-1/2" x 1-1/4"	6	24
B235-0534	G235-0534	2-1/2" x 1"	8	32
B235-0535	G235-0535	2-1/2" x 3/4"	10	40
B235-0536	G235-0536	2-1/2" x 1/2"	10	40
B235-0662	G235-0662	3" x 2-1/2"	4	16
B235-0663	G235-0663	3" x 2"	6	18
B235-0664	G235-0664	3" x 1-1/2"	5	20
B235-0870	G235-0870	4" x 3"	1	9
B235-0871	G235-0871	4" x 2-1/2"	4	8
B235-0872	G235-0872	4" x 2"	4	12

90 Deg Elbow, Banded

F x F



BLACK PRT #	GALV. PRT #	SIZE	CTN QTY	MSTR QTY
B235-0001	G235-0001	1/8"	50	600
B235-0002	G235-0002	1/4"	35	420
B235-0025	G235-0025	3/8"	45	540
B235-0050	G235-0050	1/2"	50	400
B235-0100	G235-0100	3/4"	35	210
B235-0150	G235-0150	1"	20	120
B235-0215	G235-0215	1-1/4"	20	80
B235-0295	G235-0295	1-1/2"	20	60
B235-0390	G235-0390	2"	8	32
B235-0520	G235-0520	2-1/2"	8	18
B235-0650	G235-0650	3"	7	14
B235-0860	G235-0860	4"	2	6
B235-0975	G235-0975	5"	2	4
B235-1100	G235-1100	6"	1	2

Side Outlet 90 Ell, Banded

F x F x F



BLACK PRT #	GALV. PRT #	SIZE	CTN QTY	MSTR QTY
B247-0215	—	1-1/4"	50	600

90 Street Ell, Banded

M x F



BLACK PRT #	GALV. PRT #	SIZE	CTN QTY	MSTR QTY
B254-0001	G254-0001	1/8"	60	720
B254-0002	G254-0002	1/4"	35	420
B254-0025	G254-0025	3/8"	40	480
B254-0050	G254-0050	1/2"	60	360
B254-0100	G254-0100	3/4"	35	210
B254-0150	G254-0150	1"	30	120
B254-0215	G254-0215	1-1/4"	25	75
B254-0295	G254-0295	1-1/2"	18	54
B254-0390	G254-0390	2"	10	30
B254-0520	G254-0520	2-1/2"	9	18
B254-0650	G254-0650	3"	—	14
B254-0860	G254-0860	4"	—	6

45 Deg Ell, Banded

F x F



BLACK PRT #	GALV. PRT #	SIZE	CTN QTY	MSTR QTY
B290-0001	G290-0001	1/8"	50	600
B290-0002	G290-0002	1/4"	30	360
B290-0025	G290-0025	3/8"	50	600
B290-0050	G290-0050	1/2"	50	400
B290-0100	G290-0100	3/4"	40	240
B290-0150	G290-0150	1"	20	120
B290-0215	G290-0215	1-1/4"	20	80
B290-0295	G290-0295	1-1/2"	15	60
B290-0390	G290-0390	2"	12	36
B290-0520	G290-0520	2-1/2"	—	27
B290-0650	G290-0650	3"	—	20
B290-0860	G290-0860	4"	—	6
B290-0975	G290-0975	5"	—	—
B290-1100	G290-1100	6"	—	—

45 Street Ell, Banded

M x F



BLACK PRT #	GALV. PRT #	SIZE	CTN QTY	MSTR QTY
B295-0001	G295-0001	1/8"	70	840
B295-0002	G295-0002	1/4"	40	480
B295-0025	G295-0025	3/8"	50	600
B295-0050	G295-0050	1/2"	75	450
B295-0100	G295-0100	3/4"	40	240
B295-0150	G295-0150	1"	25	150
B295-0215	G295-0215	1-1/4"	20	80
B295-0295	G295-0295	1-1/2"	20	60
B295-0390	G295-0390	2"	12	36
B295-0520	G295-0520	2-1/2"	—	25
B295-0650	G295-0650	3"	—	18
B295-0860	G295-0860	4"	—	7

Floor Flange



BLACK PRT #	GALV. PRT #	SIZE	CTN QTY	MSTR QTY
B355-0001	G355-0001	1/8"	—	—
B355-0002	G355-0002	1/4"	10	60
B355-0025	G355-0025	3/8"	25	150
B355-0050	G355-0050	1/2"	25	200
B355-0100	G355-0100	3/4"	20	160
B355-0150	G355-0150	1"	20	120
B355-0215	G355-0215	1-1/4"	15	90
B355-0295	G355-0295	1-1/2"	12	72
B355-0390	G355-0390	2"	8	48

Locknut/Backnut



BLACK PRT #	GALV. PRT #	SIZE	CTN QTY	MSTR QTY
B375-0001	G375-0001	1/8"	250	3,000
B375-0002	G375-0002	1/4"	125	1,500
B375-0025	G375-0025	3/8"	125	1,500
B375-0050	G375-0050	1/2"	100	1,200
B375-0100	G375-0100	3/4"	60	720
B375-0150	G375-0150	1"	60	480
B375-0215	G375-0215	1-1/4"	60	360
B375-0295	G375-0295	1-1/2"	45	270
B375-0390	G375-0390	2"	25	150
B375-0520	G375-0520	2-1/2"	14	84

Square Head Plug

M



BLACK PRT #	GALV. PRT #	SIZE	CTN QTY	MSTR QTY
B396-0001	G396-0001	1/8"	300	3,600
B396-0002	G396-0002	1/4"	150	1,800
B396-0025	G396-0025	3/8"	100	1,200
B396-0050	G396-0050	1/2"	50	600
B396-0100	G396-0100	3/4"	30	360
B396-0150	G396-0150	1"	20	240
B396-0215	G396-0215	1-1/4"	40	240
B396-0295	G396-0295	1-1/2"	30	180
B396-0390	G396-0390	2"	20	120
B396-0520	G396-0520	2-1/2"	8	64
B396-0650	G396-0650	3"	8	48
B396-0860	G396-0860	4"	8	16
B396-1100	G396-1100	6"	5	10

Tee, Banded

F x F x F



BLACK PRT #	GALV. PRT #	SIZE	CTN QTY	MSTR QTY
B460-0001	G460-0001	1/8"	80	960
B460-0002	G460-0002	1/4"	50	600
B460-0025	G460-0025	3/8"	45	360
B460-0050	G460-0050	1/2"	40	240
B460-0100	G460-0100	3/4"	35	140
B460-0150	G460-0150	1"	20	80
B460-0215	G460-0215	1-1/4"	14	56
B460-0295	G460-0295	1-1/2"	15	45
B460-0390	G460-0390	2"	10	30
B460-0520	G460-0520	2-1/2"	8	16
B460-0650	G460-0650	3"	6	12
B460-0860	G460-0860	4"	2	6
B460-0975	G460-0975	5"	2	2
B460-1100	G460-1100	6"	2	2

Reducing Tee, Banded

F x F x F



BLACK PRT #	GALV. PRT #	SIZE	CTN QTY	MSTR QTY
B460-0007	G460-0007	1/4" x 1/8"	25	300
B460-0032	G460-0032	3/8" x 1/4"	60	480
B460-0033	G460-0033	3/8" x 1/8"	60	480
B460-0056	G460-0056	1/2" x 1"	40	160
B460-0057	G460-0057	1/2" x 3/4"	30	180
B460-0058	G460-0058	1/2" x 3/8"	45	270
B460-0059	G460-0059	1/2" x 1/4"	50	300
B460-0060	G460-0060	1/2" x 1/8"	60	360
B460-0105	G460-0105	3/4" x 1-1/4"	25	100
B460-0106	G460-0106	3/4" x 1"	20	120
B460-0107	G460-0107	3/4" x 1/2"	45	180
B460-0108	G460-0108	3/4" x 3/8"	45	180
B460-0109	G460-0109	3/4" x 1/4"	50	200
B460-0116	G460-0116	3/4" x 1/2" x 1"	35	140
B460-0117	G460-0117	3/4" x 1/2" x 3/4"	40	160
B460-0118	G460-0118	3/4" x 1/2" x 1/2"	30	180
B460-0156	—	1" x 2"	12	48
B460-0157	G460-0157	1" x 1-1/2"	15	60
B460-0158	G460-0158	1" x 1-1/4"	15	60
B460-0159	G460-0159	1" x 3/4"	25	100
B460-0160	G460-0160	1" x 1/2"	30	120
B460-0161	G460-0161	1" x 3/8"	20	120
B460-0162	G460-0162	1" x 1/4"	25	150
B460-0169	G460-0169	1" x 3/4" x 1"	15	90
B460-0170	G460-0170	1" x 3/4" x 3/4"	25	100
B460-0171	G460-0171	1" x 3/4" x 1/2"	25	100
B460-0180	G460-0180	1" x 1/2" x 1"	15	90
B460-0181	G460-0181	1" x 1/2" x 3/4"	30	120
B460-0182	G460-0182	1" x 1/2" x 1/2"	20	120

Reducing Tee, Banded (continued)

BLACK PRT #	GALV. PRT #	SIZE	CTN QTY	MSTR QTY
B460-0220	G460-0215	1-1/4" x 2	10	40
B460-0221	G460-0221	1-1/4" x 1-1/2"	14	56
B460-0222	G460-0222	1-1/4" x 1	16	64
B460-0223	G460-0223	1-1/4" x 3/4"	18	72
B460-0224	G460-0224	1-1/4" x 1/2"	20	80
B460-0225	G460-0225	1-1/4" x 3/8"	20	80
B460-0233	G460-0233	1-1/4" x 1" x 1-1/2"	1	1
B460-0234	G460-0234	1-1/4" x 1" x 1-1/4"	15	60
B460-0235	G460-0235	1-1/4" x 1" x 1	18	72
B460-0236	G460-0236	1-1/4" x 1" x 3/4"	18	72
B460-0237	G460-0237	1-1/4" x 1" x 1/2"	18	72
B460-0245	G460-0245	1-1/4" x 3/4" x 1-1/4"	15	60
B460-0246	G460-0246	1-1/4" x 3/4" x 1	20	80
B460-0247	G460-0247	1-1/4" x 3/4" x 3/4"	20	80
B460-0248	G460-0248	1-1/4" x 3/4" x 1/2"	25	100
B460-0256	G460-0256	1-1/4" x 1/2" x 1-1/4"	15	60
B460-0257	G460-0257	1-1/4" x 1/2" x 1	20	80
B460-0258	G460-0258	1-1/4" x 1/2" x 3/4"	25	100
B460-0259	G460-0259	1-1/4" x 1/2" x 1/2"	25	100
B460-0302	G460-0302	1-1/2" x 2	030	32
B460-0303	G460-0303	1-1/2" x 1-1/4"	15	45
B460-0304	G460-0304	1-1/2" x 1	13	52
B460-0305	G460-0305	1-1/2" x 3/4"	10	60
B460-0306	G460-0306	1-1/2" x 1/2"	18	72
B460-0307	G460-0307	1-1/2" x 3/8"	18	72
B460-0315	G460-0315	1-1/2" x 1-1/4" x 1-1/2"	10	40
B460-0316	G460-0316	1-1/2" x 1-1/4" x 1-1/4"	12	48
B460-0317	G460-0317	1-1/2" x 1-1/4" x 1	14	56
B460-0318	G460-0318	1-1/2" x 1-1/4" x 3/4"	16	64
B460-0319	G460-0319	1-1/2" x 1-1/4" x 1/2"	16	64
B460-0328	G460-0328	1-1/2" x 1" x 1-1/2"	14	56
B460-0329	G460-0329	1-1/2" x 1" x 1-1/4"	14	56
B460-0330	G460-0330	1-1/2" x 1" x 1	15	60
B460-0331	G460-0331	1-1/2" x 1" x 3/4"	15	60
B460-0332	G460-0332	1-1/2" x 1" x 1/2"	18	72
B460-0339	G460-0339	1-1/2" x 3/4" x 1-1/2"	12	48
B460-0340	G460-0340	1-1/2" x 3/4" x 1-1/4"	15	60
B460-0342	G460-0342	1-1/2" x 3/4" x 3/4"	18	72
B460-0343	G460-0343	1-1/2" x 3/4" x 1/2"	20	80
B460-0350	G460-0350	1-1/2" x 1/2" x 1-1/2"	12	48
B460-0351	G460-0351	1-1/2" x 1/2" x 1-1/4"	15	60

Reducing Tee, Banded (continued)

BLACK PRT #	GALV. PRT #	SIZE	CTN QTY	MSTR QTY
B460-0352	G460-0352	1-1/2" x 1/2" x 1	18	72
B460-0353	G460-0353	1-1/2" x 1/2" x 3/4"	1	1
B460-0354	G460-0354	1-1/2" x 1/2" x 1/2"	1	1
B460-0397	G460-0397	2" x 2-1/2"	8	16
B460-0398	G460-0398	2" x 1-1/2"	16	32
B460-0399	G460-0399	2" x 1-1/4"	8	32
B460-0400	G460-0400	2" x 1	12	36
B460-0401	G460-0401	2" x 3/4"	10	40
B460-0402	G460-0402	2" x 1/2"	10	40
B460-0403	G460-0403	2" x 3/8"	10	40
B460-0413	G460-0413	2" x 1-1/2" x 2	10	30
B460-0414	G460-0414	2" x 1-1/2" x 1-1/2"	8	32
B460-0415	G460-0415	2" x 1-1/2" x 1-1/4"	8	32
B460-0416	G460-0416	2" x 1-1/2" x 1	10	40
B460-0417	G460-0417	2" x 1-1/2" x 3/4"	10	40
B460-0418	G460-0418	2" x 1-1/2" x 1/2"	10	40
B460-0429	G460-0429	2" x 1-1/4" x 2	13	26
B460-0430	G460-0430	2" x 1-1/4" x 1-1/2"	8	32
B460-0431	G460-0431	2" x 1-1/4" x 1-1/4"	12	36
B460-0432	G460-0432	2" x 1-1/4" x 1	10	40
B460-0444	G460-0444	2" x 1" x 2	8	32
B460-0447	G460-0447	2" x 1" x 1	12	48
B460-0457	G460-0457	2" x 3/4" x 2	8	32
B460-0461	G460-0461	2" x 3/4" x 3/4"	12	48
B460-0470	G460-0470	2" x 1/2" x 2	8	32
B460-0531	G460-0531	2-1/2" x 2"	4	16
B460-0532	G460-0532	2-1/2" x 1-1/2"	5	15
B460-0533	G460-0533	2-1/2" x 1-1/4"	10	20
B460-0534	G460-0534	2-1/2" x 1"	12	24
B460-0535	G460-0535	2-1/2" x 3/4"	12	24
B460-0536	G460-0536	2-1/2" x 1/2"	12	24
B460-0548	G460-0548	2-1/2" x 2" x 2-1/2"	1	16
B460-0549	G460-0549	2-1/2" x 2" x 2"	1	1
B460-0662	G460-0662	3" x 2-1/2"	6	12
B460-0663	G460-0663	3" x 2"	4	12
B460-0664	G460-0664	3" x 1-1/2"	4	12
B460-0665	G460-0665	3" x 1-1/4"	4	12
B460-0666	G460-0666	3" x 1"	5	15
B460-0667	G460-0667	3" x 3/4"	6	18
B460-0668	G460-0668	3" x 1/2"	6	18
B460-0870	G460-0870	4" x 3	2	6
B460-0871	G460-0871	4" x 2-1/2"	2	6
B460-0872	G460-0872	4" x 2"	2	8
B460-0873	G460-0873	4" x 1-1/2"	2	8
B460-0874	G460-0874	4" x 1-1/4"	2	8
B460-0875	G460-0875	4" x 1"	2	8

Street Tee, Banded

F x M x F



BLACK PRT #	GALV. PRT #	SIZE	CTN QTY	MSTR QTY
B486-0050	G486-0050	1/2"	40	240
B486-0100	G486-0100	3/4"	25	150
B486-0150	G486-0150	1"	20	80
B486-0215	G486-0215	1-1/4"	15	60
B486-0295	G486-0295	1-1/2"	12	36
B486-0390	G486-0390	2"	8	24

Union, Brass to Iron Seat



BLACK PRT #	GALV. PRT #	SIZE	CTN QTY	MSTR QTY
B657-0001	G657-0001	1/8"	30	360
B657-0002	G657-0002	1/4"	20	240
B657-0025	G657-0025	3/8"	20	240
B657-0050	G657-0050	1/2"	50	200
B657-0100	G657-0100	3/4"	35	140
B657-0150	G657-0150	1"	20	80
B657-0215	G657-0215	1-1/4"	15	60
B657-0295	G657-0295	1-1/2"	10	40
B657-0390	G657-0390	2"	6	24
B657-0520	G657-0520	2-1/2"	4	16
B657-0650	G657-0650	3"	7	14
B657-0860	G657-0860	4"	7	7

Pipe Nipples



BLACK	GALVANIZED	SIZE	CTN QTY	MSTR QTY
30100	50100	1/8" X Close	25	600
30110	50110	1/8" X 10"	25	150
30111	50111	1/8" X 11"	25	150
30112	50112	1/8" X 12"	25	150
30115	50115	1/8" X 1-1/2"	25	600
30120	50120	1/8" X 2"	25	600
30125	50125	1/8" X 2-1/2"	25	600
30130	50130	1/8" X 3"	25	600
30135	50135	1/8" X 3-1/2"	25	600
30140	50140	1/8" X 4"	25	600
30145	50145	1/8" X 4-1/2"	25	400
30150	50150	1/8" X 5"	25	400
30155	50155	1/8" X 5-1/2"	25	400
30160	50160	1/8" X 6"	25	400
30170	50170	1/8" X 7"	25	200
30180	50180	1/8" X 8"	25	200
30190	50190	1/8" X 9"	25	200
30200	50200	1/4" X Close	25	600
30210	50210	1/4" X 10"	25	150
30211	50211	1/4" X 11"	25	150
30212	50212	1/4" X 12"	25	150
30215	50215	1/4" X 1-1/2"	25	600
30220	50220	1/4" X 2"	25	600
30225	50225	1/4" X 2-1/2"	25	600
30230	50230	1/4" X 3"	25	600
30235	50235	1/4" X 3-1/2"	25	400
30240	50240	1/4" X 4"	25	400
30245	50245	1/4" X 4-1/2"	25	400
30250	50250	1/4" X 5"	25	300
30255	50255	1/4" X 5-1/2"	25	300
30260	50260	1/4" X 6"	25	300
30270	50270	1/4" X 7"	25	200
30280	50280	1/4" X 8"	25	200
30290	50290	1/4" X 9"	25	200
30300	50300	3/8" X Close	25	600
30310	50310	3/8" X 10"	25	100
30311	50311	3/8" X 11"	25	100
30312	50312	3/8" X 12"	25	100
30314	—	3/8" X 14"	5	10
30315	50315	3/8" X 1-1/2"	25	600
30320	50320	3/8" X 2"	25	600
30325	50325	3/8" X 2-1/2"	25	400
30330	50330	3/8" X 3"	25	400
30335	50335	3/8" X 3-1/2"	25	400
30340	50340	3/8" X 4"	25	300
30345	50345	3/8" X 4-1/2"	25	300
30350	50350	3/8" X 5"	25	300
30355	50355	3/8" X 5-1/2"	25	200
30360	50360	3/8" X 6"	25	200
30370	50370	3/8" X 7"	25	200

BLACK	GALVANIZED	SIZE	CTN QTY	MSTR QTY
30380	50380	3/8" X 8"	25	150
30390	50390	3/8" X 9"	25	150
30500	50500	1/2" X Close	25	600
30510	50510	1/2" X 10"	25	75
30511	50511	1/2" X 11"	25	75
30512	50512	1/2" X 12"	25	75
30515	50515	1/2" X 1-1/2"	25	600
30520	50520	1/2" X 2"	25	600
30525	50525	1/2" X 2-1/2"	25	400
30530	50530	1/2" X 3"	25	400
30535	50535	1/2" X 3-1/2"	25	300
30540	50540	1/2" X 4"	25	300
30545	50545	1/2" X 4-1/2"	25	200
30550	50550	1/2" X 5"	25	200
30555	50555	1/2" X 5-1/2"	25	200
30560	50560	1/2" X 6"	25	200
30570	50570	1/2" X 7"	25	100
30575	—	1/2" X 7-1/2"	25	100
30580	50580	1/2" X 8"	25	100
30590	50590	1/2" X 9"	25	100
30700	50700	3/4" X Close	25	400
30710	50710	3/4" X 10"	25	50
30711	50711	3/4" X 11"	25	50
30712	50712	3/4" X 12"	25	50
30715	50715	3/4" X 1-1/2"	25	400
30720	50720	3/4" X 2"	25	300
30725	50725	3/4" X 2-1/2"	25	300
30730	50730	3/4" X 3"	25	200
30735	50735	3/4" X 3-1/2"	25	200
30740	50740	3/4" X 4"	25	150
30745	50745	3/4" X 4-1/2"	25	150
30750	50750	3/4" X 5"	25	100
30755	50755	3/4" X 5-1/2"	25	100
30760	50760	3/4" X 6"	25	100
30765	—	3/4" X 6-1/2"	25	75
30770	50770	3/4" X 7"	25	75
30775	50775	3/4" X 7-1/2"	25	75
30780	50780	3/4" X 8"	25	75
30790	50790	3/4" X 9"	25	75
31000	51000	1" X Close	25	300
31010	51010	1" X 10"	25	50
31011	51011	1" X 11"	25	50
31012	51012	1" X 12"	25	50
31014	51014	1" X 14"	5	10
31020	51020	1" X 2"	25	200
31025	51025	1" X 2-1/2"	25	200
31030	51030	1" X 3"	25	150
31035	51035	1" X 3-1/2"	25	150
31040	51040	1" X 4"	25	100
31045	51045	1" X 4-1/2"	25	100
31050	51050	1" X 5"	25	100
31055	51055	1" X 5-1/2"	25	75
31060	51060	1" X 6"	25	75
31065	—	1" X 6-1/2"	25	50
31070	51070	1" X 7"	25	50
31075	—	1" X 7-1/2"	25	50
31080	51080	1" X 8"	25	50

BLACK	GALVANIZED	SIZE	CTN QTY	MSTR QTY
31085	—	1" X 8-1/2"	25	50
31090	51090	1" X 9"	25	50
31095	—	1" X 9-1/2"	25	50
31200	51200	1-1/4" X Close	25	150
31210	51210	1-1/4" X 10"	20	40
31211	51211	1-1/4" X 11"	20	40
31212	51212	1-1/4" X 12"	10	30
31213	—	1-1/4" X 13"	3	6
31214	—	1-1/4" X 14"	3	6
—	51215	1-1/4" X 1-1/2"	25	150
31220	51220	1-1/4" X 2"	25	150
31225	51225	1-1/4" X 2-1/2"	25	150
31230	51230	1-1/4" X 3"	25	100
31235	51235	1-1/4" X 3-1/2"	25	100
31240	51240	1-1/4" X 4"	25	100
31245	51245	1-1/4" X 4-1/2"	25	75
31250	51250	1-1/4" X 5"	25	75
31255	51255	1-1/4" X 5-1/2"	25	75
31260	51260	1-1/4" X 6"	25	50
31265	—	1-1/4" X 6-1/2"	25	50
31270	51270	1-1/4" X 7"	25	50
31280	51280	1-1/4" X 8"	25	50
31285	—	1-1/4" X 8-1/2"	25	30
31290	51290	1-1/4" X 9"	25	50
31295	—	1-1/4" X 9-1/2"	20	40
31500	51500	1-1/2" X Close	25	100
31510	51510	1-1/2" X 10"	30	30
31511	51511	1-1/2" X 11"	20	20
31512	51512	1-1/2" X 12"	20	20
31514	—	1-1/2" X 14"	3	6
31520	51520	1-1/2" X 2"	25	75
31525	51525	1-1/2" X 2-1/2"	25	75
31530	51530	1-1/2" X 3"	25	50
31535	51535	1-1/2" X 3-1/2"	25	50
31540	51540	1-1/2" X 4"	25	50
31545	51545	1-1/2" X 4-1/2"	25	50
31550	51550	1-1/2" X 5"	25	50
31555	51555	1-1/2" X 5-1/2"	25	50
31560	51560	1-1/2" X 6"	25	50
31570	51570	1-1/2" X 7"	20	40
31580	51580	1-1/2" X 8"	20	40
31590	51590	1-1/2" X 9"	10	30
32000	52000	2" X Close	25	75
32010	52010	2" X 10"	15	15
32011	52011	2" X 11"	15	15
32012	52012	2" X 12"	15	15
32013	—	2" X 13"	3	6
32025	52025	2" X 2-1/2"	25	50
32030	52030	2" X 3"	25	50
32035	52035	2" X 3-1/2"	25	50
32040	52040	2" X 4"	25	25
32045	52045	2" X 4-1/2"	25	25
32050	52050	2" X 5"	25	25
32055	52055	2" X 5-1/2"	25	25
32060	52060	2" X 6"	25	25
32065	—	2" X 6-1/2"	20	20
32070	52070	2" X 7"	20	20

BLACK	GALVANIZED	SIZE	CTN QTY	MSTR QTY
32075	—	2" X 7-1/2"	20	20
32080	52080	2" X 8"	20	20
32090	52090	2" X 9"	20	20
32500	52500	2-1/2" X Close	20	40
32510	52510	2-1/2" X 10"	10	10
32511	52511	2-1/2" X 11"	10	10
32512	52512	2-1/2" X 12"	10	10
32514	—	2-1/2" X 14"	3	6
32530	52530	2-1/2" X 3"	20	40
32535	52535	2-1/2" X 3-1/2"	30	30
32540	52540	2-1/2" X 4"	30	30
32545	52545	2-1/2" X 4-1/2"	30	30
32550	52550	2-1/2" X 5"	20	20
32555	52555	2-1/2" X 5-1/2"	20	20
32560	52560	2-1/2" X 6"	20	20
32565	—	2-1/2" X 6-1/2"	20	20
32570	52570	2-1/2" X 7"	20	20
32580	52580	2-1/2" X 8"	10	10
32590	52590	2-1/2" X 9"	10	10
33000	53000	3" X Close	30	30
33010	53010	3" X 10"	5	5
33011	53011	3" X 11"	5	5
33012	53012	3" X 12"	5	5
33030	53030	3" X 3"	20	20
33035	53035	3" X 3-1/2"	15	15
33040	53040	3" X 4"	15	15
33045	53045	3" X 4-1/2"	15	15
33050	53050	3" X 5"	15	15
33055	53055	3" X 5-1/2"	15	15
33060	53060	3" X 6"	10	10
33070	53070	3" X 7"	7	7
33080	53080	3" X 8"	7	7
33090	53090	3" X 9"	7	7
33500	—	3-1/2" X Close	20	20
33540	—	3-1/2" X 4"	10	10
33550	53550	3-1/2" X 5"	8	8
33555	—	3-1/2" X 5-1/2"	8	8
33580	—	3-1/2" X 8"	6	6
34000	54000	4" X Close	20	20
34010	54010	4" X 10"	4	4
34011	54011	4" X 11"	4	4
34012	54012	4" X 12"	4	4
34014	—	4" X 14"	2	2
34035	54035	4" X 3-1/2"	10	10
34040	54040	4" X 4"	10	10
34045	54045	4" X 4-1/2"	8	8
34050	54050	4" X 5"	8	8
34055	54055	4" X 5-1/2"	8	8
34060	54060	4" X 6"	8	8
34070	54070	4" X 7"	4	4
34080	54080	4" X 8"	4	4
34090	54090	4" X 9"	4	4
35000	—	5" X Close	1	5
35045	—	5" X 4-1/2"	1	5
35050	—	5" X 5"	1	5
35055	—	5" X 5-1/2"	1	5
35060	—	5" X 6"	1	5

BLACK	GALVANIZED	SIZE	CTN QTY	MSTR QTY
35070	—	5" X 7"	1	5
35080	—	5" X 8"	1	5
36000	56000	6" X Close	1	5
36010	56010	6" X 10"	1	3
36011	56011	6" X 11"	1	3
36012	56012	6" X 12"	3	3
36040	56040	6" X 4"	1	5
36045	56045	6" X 4-1/2"	1	5
36050	56050	6" X 5"	1	5
36055	56055	6" X 5-1/2"	1	5
36060	56060	6" X 6"	1	5
36070	56070	6" X 7"	1	4
36080	56080	6" X 8"	1	4
36090	56090	6" X 9"	1	4
31210TOE	—	1-1/4" X 10"	20	40
31212TOE	—	1-1/4" X 12"	10	30
31215TOE	—	1-1/4" X 15"	1	1
31510TOE	—	1-1/2" X 10"	1	1

XHY Pipe Nipple				
BLACK	GALVANIZED	SIZE	CTN QTY	
40200	—	1/4" X Close	1	
40300	—	3/8" X Close	1	
40500	—	1/2" X Close	1	
40700	—	3/4" X Close	1	
41000	—	1" X Close	1	
41200	—	1-1/4" X Close	1	
41500	—	1-1/2" X Close	1	
42000	—	2" X Close	1	

Installation Kit				
BLACK	GALVANIZED	SIZE	CTN QTY	MSTR QTY
BI05	GI05	1/2"	1	1
BI07	GI07	3/4"	1	1
BI10	GI10	1"	1	1
BI12	GI12	1-1/4"	1	1
BI15	GI15	1-1/2"	1	1
BI20	GI20	2"	1	1

Ever Ready Kit				
BLACK	GALVANIZED	SIZE	CTN QTY	MSTR QTY
ERB05	ERG05	1/2"	1	1
ERB07	ERG07	3/4"	1	1

C-Assort				
BLACK	GALVANIZED	SIZE	CTN QTY	MSTR QTY
CB05	CG05	1/2"	1	1
CB07	CG07	3/4"	1	1
CB10	CG10	1"	1	1
CB12	CG12	1-1/4"	1	1
CB15	—	1-1/2"	1	1

A-Assort				
BLACK	GALVANIZED	SIZE	CTN QTY	MSTR QTY
AB05	AG05	1/2"	1	1
AB07	AG07	3/4"	1	1
AB10	AG10	1"	1	1

6-Pack Assort				
BLACK	GALVANIZED	SIZE	CTN QTY	MSTR QTY
605B	605G	1/2"	1	1
607B	607G	3/4"	1	1
610B	610G	1"	1	1

Readycut Pipe



BLACK	GALVANIZED	SIZE	CTN QTY	MSTR QTY
—	301 G0118	1/8" X 18"	5	10
—	301 G0124	1/8" X 24"	5	10
—	301 G0130	1/8" X 30"	5	10
—	301 G0136	1/8" X 36"	5	10
—	301 G0148	1/8" X 48"	5	10
—	301 G0160	1/8" X 60"	5	10
—	301 G0172	1/8" X 72"	5	10
300 B0218	301 G0218	1/4" X 18"	5	10
300 B0224	301 G0224	1/4" X 24"	5	10
300 B0230	301 G0230	1/4" X 30"	5	10
300 B0236	301 G0236	1/4" X 36"	5	10
300 B0248	301 G0248	1/4" X 48"	5	10
300 B0260	301 G0260	1/4" X 60"	5	10
300 B0272	301 G0272	1/4" X 72"	5	10
300 B0318	301 G0318	3/8" X 18"	5	10
300 B0324	301 G0324	3/8" X 24"	5	10
300 B0330	301 G0330	3/8" X 30"	5	10
300 B0336	301 G0336	3/8" X 36"	5	10
300 B0348	301 G0348	3/8" X 48"	5	10
300 B0360	301 G0360	3/8" X 60"	5	10
300 B0372	301 G0372	3/8" X 72"	5	10
300 B0518	301 G0518	1/2" X 18"	5	10
300 B0524	301 G0524	1/2" X 24"	5	10
300 B0530	301 G0530	1/2" X 30"	5	10
300 B0536	301 G0536	1/2" X 36"	5	10
300 B0542	301 G0542	1/2" X 42"	5	10
300 B0548	301 G0548	1/2" X 48"	5	10
300 B0554	301 G0554	1/2" X 54"	5	10
300 B0560	301 G0560	1/2" X 60"	5	10
300 B0572	301 G0572	1/2" X 72"	5	10
300 B0718	301 G0718	3/4" X 18"	5	10
300 B0724	301 G0724	3/4" X 24"	5	10
300 B0730	301 G0730	3/4" X 30"	5	10
300 B0736	301 G0736	3/4" X 36"	5	10
300 B0742	301 G0742	3/4" X 42"	5	10
300 B0748	301 G0748	3/4" X 48"	5	10
300 B0754	301 G0754	3/4" X 54"	5	10
300 B0760	301 G0760	3/4" X 60"	5	10
300 B0772	301 G0772	3/4" X 72"	5	10
300 B1018	301 G1018	1" X 18"	5	10
300 B1024	301 G1024	1" X 24"	5	10
300 B1030	301 G1030	1" X 30"	5	10
300 B1036	301 G1036	1" X 36"	5	10
300 B1042	301 G1042	1" X 42"	5	10
300 B1048	301 G1048	1" X 48"	5	10
300 B1054	301 G1054	1" X 54"	5	10
300 B1060	301 G1060	1" X 60"	3	6
300 B1066	—	1" X 66"	3	6
300 B1072	301 G1072	1" X 72"	3	6
300 B1218	301 G1218	1-1/4" X 18"	3	6
—	301 G1220	1-1/4" X 20"	3	6

BLACK	GALVANIZED	SIZE	CTN QTY	MSTR QTY
300 B1224	301 G1224	1-1/4" X 24"	3	6
300 B1230	301 G1230	1-1/4" X 30"	3	6
300 B1236	301 G1236	1-1/4" X 36"	3	6
300 B1242	301 G1242	1-1/4" X 42"	3	6
300 B1248	301 G1248	1-1/4" X 48"	3	6
300 B1254	301 G1254	1-1/4" X 54"	3	6
300 B1260	301 G1260	1-1/4" X 60"	3	6
300 B1272	301 G1272	1-1/4" X 72"	3	6
300 B1518	301 G1518	1-1/2" X 18"	3	6
300 B1524	301 G1524	1-1/2" X 24"	3	6
300 B1530	301 G1530	1-1/2" X 30"	3	6
300 B1536	301 G1536	1-1/2" X 36"	3	6
300 B1542	301 G1542	1-1/2" X 42"	3	6
300 B1548	301 G1548	1-1/2" X 48"	3	6
300 B1554	301 G1554	1-1/2" X 54"	3	6
300 B1560	301 G1560	1-1/2" X 60"	3	6
300 B1572	301 G1572	1-1/2" X 72"	3	6
300 B2018	301 G2018	2" X 18"	3	6
300 B2024	301 G2024	2" X 24"	3	6
300 B2030	301 G2030	2" X 30"	3	6
300 B2036	301 G2036	2" X 36"	3	6
300 B2042	301 G2042	2" X 42"	3	6
300 B2048	301 G2048	2" X 48"	3	6
300 B2054	301 G2054	2" X 54"	3	6
300 B2060	301 G2060	2" X 60"	3	6
300 B2072	301 G2072	2" X 72"	3	6
32518	52518	2-1/2" X 18"	3	6
32520	—	2-1/2" X 20"	3	6
32524	52524	2-1/2" X 24"	3	6
300 B2530	—	2-1/2" X 30"	3	6
300 B2560	—	2-1/2" X 60"	3	6
33018	301 G3018	3" X 18"	2	4
300 B3024	301 G3024	3" X 24"	2	4
300 B3036	—	3" X 36"	2	4
300 B4018	301 G4018	4" X 18"	2	2
34024	54024	4" X 24"	2	2
—	301 G4048	4" X 48"	2	2
300 B4060	—	4" X 60"	2	2

Standard Merchant Couplings

BLACK PART NO.	GALV. PART NO.	SIZE	CTN QTY
M301	M101	1/8"	100
M302	M102	1/4"	100
M303	M103	3/8"	100
M305	M105	1/2"	100
M307	M107	3/4"	50
M310	M110	1"	30
M312	M112	1-1/4"	25
M315	M115	1-1/2"	25
M320	M120	2"	20
M325	M125	2-1/2"	10
M330	M130	3"	10
M340	M140	4"	10

Standard Merchant Half Couplings

BLACK PART NO.	GALV. PART NO.	SIZE	CTN QTY
H305	H105	1/2"	8
H307	H107	3/4"	12
H310	H110	1"	18
H312	H112	1-1/4"	23
H315	H115	1-1/2"	32
H320	H120	2"	47

45 Deg Ell, Banded.....	4
45 Street Ell, Banded.....	4
90 Deg Elbow, Banded.....	3
90 Deg Reducing Elbow, Banded.....	3
90 Street Ell, Banded.....	3
C	
Cap.....	1
Coupling, Banded.....	2
Cross, Banded.....	2
E	
Extension Piece.....	1
F	
Floor Flange.....	4
H	
Hexagon Bushings.....	1
L	
Locknut/Backnut.....	4
M	
Merchant Couplings.....	11
P	
Pipe Nipple Black.....	7, 8, 9, 11
R	
Readycut Pipe Black.....	10
Reducing Coupling, Banded.....	2
Reducing Tee, Banded.....	5, 6
S	
Side Outlet 90 Ell, Banded.....	3
Square Head Plug.....	4
Street Tee, Banded.....	6
T	
Tee, Banded.....	5
U	
Union, Brass to Iron Seat.....	6

PART NO.	PG #	PART NO.	PG #	PART NO.	PG #	PART NO.	PG #
30100	7	30570	7	31510	8	33080	8
30110	7	30575	7	31511	8	33090	8
30111	7	30580	7	31512	8	33500	8
30112	7	30590	7	31514	8	33540	8
30115	7	30700	7	31520	8	33550	8
30120	7	30710	7	31525	8	33555	8
30125	7	30711	7	31530	8	33580	8
30130	7	30712	7	31535	8	34000	8
30135	7	30715	7	31540	8	34010	8
30140	7	30720	7	31545	8	34011	8
30145	7	30725	7	31550	8	34012	8
30150	7	30730	7	31555	8	34014	8
30155	7	30735	7	31560	8	34024	10
30160	7	30740	7	31570	8	34035	8
30170	7	30745	7	31580	8	34040	8
30180	7	30750	7	31590	8	34045	8
30190	7	30755	7	32000	8	34050	8
30200	7	30760	7	32010	8	34055	8
30210	7	30765	7	32011	8	34060	8
30211	7	30770	7	32012	8	34070	8
30212	7	30775	7	32013	8	34080	8
30215	7	30780	7	32025	8	34090	8
30220	7	30790	7	32030	8	35000	8
30225	7	31000	7	32035	8	35045	8
30230	7	31010	7	32040	8	35050	8
30235	7	31011	7	32045	8	35055	8
30240	7	31012	7	32050	8	35060	8
30245	7	31014	7	32055	8	35070	9
30250	7	31020	7	32060	8	35080	9
30255	7	31025	7	32065	8	36000	9
30260	7	31030	7	32070	8	36010	9
30270	7	31035	7	32075	8	36011	9
30280	7	31040	7	32080	8	36012	9
30290	7	31045	7	32090	8	36040	9
30300	7	31050	7	32500	8	36045	9
30310	7	31055	7	32510	8	36050	9
30311	7	31060	7	32511	8	36055	9
30312	7	31065	7	32512	8	36060	9
30314	7	31070	7	32514	8	36070	9
30315	7	31075	7	32518	10	36080	9
30320	7	31080	7	32520	10	36090	9
30325	7	31085	8	32524	10	40200	9
30330	7	31090	8	32530	8	40300	9
30335	7	31095	8	32535	8	40500	9
30340	7	31200	8	32540	8	40700	9
30345	7	31210	8	32545	8	41000	9
30350	7	31211	8	32550	8	41200	9
30355	7	31212	8	32555	8	41500	9
30360	7	31213	8	32560	8	42000	9
30370	7	31214	8	32565	8	50100	7
30380	7	31220	8	32570	8	50110	7
30390	7	31225	8	32580	8	50111	7
30500	7	31230	8	32590	8	50112	7
30510	7	31235	8	33000	8	50115	7
30511	7	31240	8	33010	8	50120	7
30512	7	31245	8	33011	8	50125	7
30515	7	31250	8	33012	8	50130	7
30520	7	31255	8	33018	10	50135	7
30525	7	31260	8	33030	8	50140	7
30530	7	31265	8	33035	8	50145	7
30535	7	31270	8	33040	8	50150	7
30540	7	31280	8	33045	8	50155	7
30545	7	31285	8	33050	8	50160	7
30550	7	31290	8	33055	8	50170	7
30555	7	31295	8	33060	8	50180	7
30560	7	31500	8	33070	8	50190	7

PART NO.	PG #
50200	7
50210	7
50211	7
50212	7
50215	7
50220	7
50225	7
50230	7
50235	7
50240	7
50245	7
50250	7
50255	7
50260	7
50270	7
50280	7
50290	7
50300	7
50310	7
50311	7
50312	7
50315	7
50320	7
50325	7
50330	7
50335	7
50340	7
50345	7
50350	7
50355	7
50360	7
50370	7
50380	7
50390	7
50500	7
50510	7
50511	7
50512	7
50515	7
50520	7
50525	7
50530	7
50535	7
50540	7
50545	7
50550	7
50555	7
50560	7
50570	7
50580	7
50590	7
50700	7
50710	7
50711	7
50712	7
50715	7
50720	7
50725	7
50730	7
50735	7
50740	7
50745	7
50750	7
50755	7
50760	7
50770	7

PART NO.	PG #
50775	7
50780	7
50790	7
51000	7
51010	7
51011	7
51012	7
51014	7
51020	7
51025	7
51030	7
51035	7
51040	7
51045	7
51050	7
51055	7
51060	7
51070	7
51080	7
51090	9
51200	9
51210	9
51211	9
51212	9
51215	9
51220	9
51225	9
51230	9
51235	9
51240	9
51245	9
51250	9
51255	9
51260	9
51270	9
51280	9
51290	9
51500	9
51510	9
51511	9
51512	9
51520	9
51525	9
51530	9
51535	9
51540	9
51545	9
51550	9
51555	9
51560	9
51570	9
51580	9
51590	9
52000	9
52010	9
52011	9
52012	9
52025	9
52030	9
52035	9
52040	9
52045	9
52050	9
52055	9
52060	9
52070	9

PART NO.	PG #
52080	9
52090	9
52500	9
52510	9
52511	9
52512	9
52518	10
52524	10
52530	9
52535	9
52540	9
52545	9
52550	9
52555	9
52560	9
52570	9
52580	9
52590	9
53000	9
53010	9
53011	9
53012	9
53030	9
53035	9
53040	9
53045	9
53050	9
53055	9
53060	9
53070	9
53080	9
53090	9
53550	9
54000	9
54010	9
54011	9
54012	9
54024	10
54035	9
54040	9
54045	9
54050	9
54055	9
54060	9
54070	9
54080	9
54090	9
56000	9
56010	9
56011	9
56012	9
56040	9
56045	9
56050	9
56055	9
56060	9
56070	9
56080	9
56090	9
300 B0218	10
300 B0224	10
300 B0230	10
300 B0236	10
300 B0248	10
300 B0260	10
300 B0272	10

PART NO.	PG #
300 B0318	10
300 B0324	10
300 B0330	10
300 B0336	10
300 B0348	10
300 B0360	10
300 B0372	10
300 B0518	10
300 B0524	10
300 B0530	10
300 B0536	10
300 B0542	10
300 B0548	10
300 B0554	10
300 B0560	10
300 B0572	10
300 B0718	10
300 B0724	10
300 B0730	10
300 B0736	10
300 B0742	10
300 B0748	10
300 B0754	10
300 B0760	10
300 B0772	10
300 B1018	10
300 B1024	10
300 B1030	10
300 B1036	10
300 B1042	10
300 B1048	10
300 B1054	10
300 B1060	10
300 B1066	10
300 B1072	10
300 B1218	10
300 B1224	10
300 B1230	10
300 B1236	10
300 B1242	10
300 B1248	10
300 B1254	10
300 B1260	10
300 B1272	10
300 B1518	10
300 B1524	10
300 B1530	10
300 B1536	10
300 B1542	10
300 B1548	10
300 B1554	10
300 B1560	10
300 B1572	10
300 B2018	10
300 B2024	10
300 B2030	10
300 B2036	10
300 B2042	10
300 B2048	10
300 B2054	10
300 B2060	10
300 B2072	10
300 B2530	10
300 B2560	10
300 B3024	10
300 B3036	10

PART NO.	PG #	PART NO.	PG #	PART NO.	PG #	PART NO.	PG #
300 B4018	10	301 G1554	10	B144-0534	1	B165-0398	2
300 B4060	10	301 G1560	10	B144-0535	1	B165-0399	2
301 G0118	10	301 G1572	10	B144-0536	1	B165-0400	2
301 G0124	10	301 G2018	10	B144-0662	1	B165-0401	2
301 G0130	10	301 G2024	10	B144-0663	1	B165-0402	2
301 G0136	10	301 G2030	10	B144-0664	1	B165-0520	2
301 G0148	10	301 G2036	10	B144-0665	1	B165-0531	2
301 G0160	10	301 G2042	10	B144-0666	1	B165-0532	2
301 G0172	10	301 G2048	10	B144-0667	1	B165-0533	2
301 G0218	10	301 G2054	10	B144-0668	1	B165-0534	2
301 G0224	10	301 G2060	10	B144-0790	1	B165-0535	2
301 G0230	10	301 G2072	10	B144-0870	1	B165-0650	2
301 G0236	10	301 G3018	10	B144-0871	1	B165-0662	2
301 G0248	10	301 G3024	10	B144-0872	1	B165-0663	2
301 G0260	10	301 G4018	10	B144-0873	1	B165-0664	2
301 G0272	10	301 G4048	10	B144-0874	1	B165-0665	2
301 G0318	10	31210TOE	9	B144-0875	1	B165-0666	2
301 G0324	10	31212TOE	9	B144-0876	1	B165-0667	2
301 G0330	10	31215TOE	9	B144-1109	1	B165-0668	2
301 G0336	10	31510TOE	9	B144-1111	1	B165-0860	2
301 G0348	10	605B	9	B155-0001	1	B165-0870	2
301 G0360	10	605G	9	B155-0002	1	B165-0871	2
301 G0372	10	607B	9	B155-0025	1	B165-0872	2
301 G0518	10	607G	9	B155-0050	1	B165-0873	2
301 G0524	10	610B	9	B155-0100	1	B165-0874	2
301 G0530	10	610G	9	B155-0150	1	B165-0875	2
301 G0536	10	AB05	9	B155-0215	1	B165-1100	2
301 G0542	10	AB07	9	B155-0295	1	B165-1109	2
301 G0548	10	AB10	9	B155-0390	1	B165-1111	2
301 G0554	10	AG05	9	B155-0520	1	B195-0001	2
301 G0560	10	AG07	9	B155-0650	1	B195-0002	2
301 G0572	10	AG10	9	B155-0860	1	B195-0025	2
301 G0718	10	B144-0007	1	B155-0975	1	B195-0050	2
301 G0724	10	B144-0032	1	B155-1100	1	B195-0100	2
301 G0730	10	B144-0033	1	B165-0001	2	B195-0150	2
301 G0736	10	B144-0058	1	B165-0002	2	B195-0215	2
301 G0742	10	B144-0059	1	B165-0007	2	B195-0295	2
301 G0748	10	B144-0060	1	B165-0025	2	B195-0390	2
301 G0754	10	B144-0107	1	B165-0032	2	B195-0520	2
301 G0760	10	B144-0108	1	B165-0033	2	B195-0650	2
301 G0772	10	B144-0109	1	B165-0050	2	B195-0860	2
301 G1018	10	B144-0110	1	B165-0058	2	B235-0001	3
301 G1024	10	B144-0159	1	B165-0059	2	B235-0002	3
301 G1030	10	B144-0160	1	B165-0060	2	B235-0007	3
301 G1036	10	B144-0161	1	B165-0100	2	B235-0025	3
301 G1042	10	B144-0162	1	B165-0107	2	B235-0032	3
301 G1048	10	B144-0222	1	B165-0108	2	B235-0050	3
301 G1054	10	B144-0223	1	B165-0109	2	B235-0058	3
301 G1060	10	B144-0224	1	B165-0110	2	B235-0059	3
301 G1072	10	B144-0225	1	B165-0150	2	B235-0060	3
301 G1218	10	B144-0226	1	B165-0159	2	B235-0100	3
301 G1220	10	B144-0303	1	B165-0160	2	B235-0107	3
301 G1224	10	B144-0304	1	B165-0161	2	B235-0108	3
301 G1230	10	B144-0305	1	B165-0162	2	B235-0109	3
301 G1236	10	B144-0306	1	B165-0215	2	B235-0150	3
301 G1242	10	B144-0307	1	B165-0222	2	B235-0159	3
301 G1248	10	B144-0308	1	B165-0223	2	B235-0160	3
301 G1254	10	B144-0398	1	B165-0224	2	B235-0161	3
301 G1260	10	B144-0399	1	B165-0225	2	B235-0215	3
301 G1272	10	B144-0400	1	B165-0295	2	B235-0222	3
301 G1518	10	B144-0401	1	B165-0303	2	B235-0223	3
301 G1524	10	B144-0402	1	B165-0304	2	B235-0224	3
301 G1530	10	B144-0403	1	B165-0305	2	B235-0295	3
301 G1536	10	B144-0531	1	B165-0306	2	B235-0303	3
301 G1542	10	B144-0532	1	B165-0307	2	B235-0304	3
301 G1548	10	B144-0533	1	B165-0390	2	B235-0305	3

PART NO.	PG #
B235-0306	3
B235-0390	3
B235-0398	3
B235-0399	3
B235-0400	3
B235-0401	3
B235-0402	3
B235-0520	3
B235-0531	3
B235-0532	3
B235-0533	3
B235-0534	3
B235-0535	3
B235-0536	3
B235-0650	3
B235-0662	3
B235-0663	3
B235-0664	3
B235-0860	3
B235-0870	3
B235-0871	3
B235-0872	3
B235-0975	3
B235-1100	3
B247-0215	3
B254-0001	3
B254-0002	3
B254-0025	3
B254-0050	3
B254-0100	3
B254-0150	3
B254-0215	3
B254-0295	3
B254-0390	3
B254-0520	3
B254-0650	3
B254-0860	3
B290-0001	4
B290-0002	4
B290-0025	4
B290-0050	4
B290-0100	4
B290-0150	4
B290-0215	4
B290-0295	4
B290-0390	4
B290-0520	4
B290-0650	4
B290-0860	4
B290-0975	4
B290-1100	4
B295-0001	4
B295-0002	4
B295-0025	4
B295-0050	4
B295-0100	4
B295-0150	4
B295-0215	4
B295-0295	4
B295-0390	4
B295-0520	4
B295-0650	4
B295-0860	4
B335-0050	1
B335-0100	1
B335-0150	1

PART NO.	PG #
B335-0215	1
B335-0295	1
B335-0390	1
B355-0001	4
B355-0002	4
B355-0025	4
B355-0050	4
B355-0100	4
B355-0150	4
B355-0215	4
B355-0295	4
B355-0390	4
B375-0001	4
B375-0002	4
B375-0025	4
B375-0050	4
B375-0100	4
B375-0150	4
B375-0215	4
B375-0295	4
B375-0390	4
B375-0520	4
B396-0001	4
B396-0002	4
B396-0025	4
B396-0050	4
B396-0100	4
B396-0150	4
B396-0215	4
B396-0295	4
B396-0390	4
B396-0520	4
B396-0650	4
B396-0860	4
B396-1100	4
B460-0001	5
B460-0002	5
B460-0007	5
B460-0025	5
B460-0032	5
B460-0033	5
B460-0050	5
B460-0056	5
B460-0057	5
B460-0058	5
B460-0059	5
B460-0060	5
B460-0100	5
B460-0105	5
B460-0106	5
B460-0107	5
B460-0108	5
B460-0109	5
B460-0116	5
B460-0117	5
B460-0118	5
B460-0150	5
B460-0156	5
B460-0157	5
B460-0158	5
B460-0159	5
B460-0160	5
B460-0161	5
B460-0162	5
B460-0169	5
B460-0170	5

PART NO.	PG #
B460-0171	5
B460-0180	5
B460-0181	5
B460-0182	5
B460-0215	5
B460-0220	5
B460-0221	5
B460-0222	5
B460-0223	5
B460-0224	5
B460-0225	5
B460-0233	5
B460-0234	5
B460-0235	5
B460-0236	5
B460-0237	5
B460-0245	5
B460-0246	5
B460-0247	5
B460-0248	5
B460-0256	5
B460-0257	5
B460-0258	5
B460-0259	5
B460-0295	5
B460-0302	5
B460-0303	5
B460-0304	5
B460-0305	5
B460-0306	5
B460-0307	5
B460-0315	5
B460-0316	5
B460-0317	5
B460-0318	5
B460-0319	5
B460-0328	5
B460-0329	5
B460-0330	5
B460-0331	5
B460-0332	5
B460-0339	5
B460-0340	5
B460-0342	5
B460-0343	5
B460-0350	5
B460-0351	5
B460-0352	6
B460-0353	6
B460-0354	6
B460-0390	5
B460-0397	6
B460-0398	6
B460-0399	6
B460-0400	6
B460-0401	6
B460-0402	6
B460-0403	6
B460-0413	6
B460-0414	6
B460-0415	6
B460-0416	6
B460-0417	6
B460-0418	6
B460-0429	6
B460-0430	6

PART NO.	PG #
B460-0431	6
B460-0432	6
B460-0444	6
B460-0447	6
B460-0457	6
B460-0461	6
B460-0470	6
B460-0520	5
B460-0531	6
B460-0532	6
B460-0533	6
B460-0534	6
B460-0535	6
B460-0536	6
B460-0548	6
B460-0549	6
B460-0650	5
B460-0662	6
B460-0663	6
B460-0664	6
B460-0665	6
B460-0666	6
B460-0667	6
B460-0668	6
B460-0860	5
B460-0870	6
B460-0871	6
B460-0872	6
B460-0873	6
B460-0874	6
B460-0875	6
B460-0975	5
B460-1100	5
B486-0050	6
B486-0100	6
B486-0150	6
B486-0215	6
B486-0295	6
B486-0390	6
B657-0001	6
B657-0002	6
B657-0025	6
B657-0050	6
B657-0100	6
B657-0150	6
B657-0215	6
B657-0295	6
B657-0390	6
B657-0520	6
B657-0650	6
B657-0860	6
BI05	9
BI07	9
BI10	9
BI12	9
BI15	9
BI20	9
CB05	9
CB07	9
CB10	9
CB12	9
CB15	9
CG05	9
CG07	9
CG10	9
CG12	9

PART NO.	PG #	PART NO.	PG #	PART NO.	PG #	PART NO.	PG #
ERB05	9	G155-0390	1	G165-1109	2	G254-0050	3
ERB07	9	G155-0520	1	G165-1111	2	G254-0100	3
ERG05	9	G155-0650	1	G195-0001	2	G254-0150	3
ERG07	9	G155-0860	1	G195-0002	2	G254-0215	3
G144-0007	1	G155-0975	1	G195-0025	2	G254-0295	3
G144-0032	1	G155-1100	1	G195-0050	2	G254-0390	3
G144-0033	1	G165-0001	2	G195-0100	2	G254-0520	3
G144-0058	1	G165-0002	2	G195-0150	2	G254-0650	3
G144-0059	1	G165-0007	2	G195-0215	2	G254-0860	3
G144-0060	1	G165-0025	2	G195-0295	2	G290-0001	4
G144-0107	1	G165-0032	2	G195-0390	2	G290-0002	4
G144-0108	1	G165-0033	2	G195-0520	2	G290-0025	4
G144-0109	1	G165-0050	2	G195-0650	2	G290-0050	4
G144-0110	1	G165-0058	2	G195-0860	2	G290-0100	4
G144-0159	1	G165-0059	2	G235-0001	3	G290-0150	4
G144-0160	1	G165-0060	2	G235-0002	3	G290-0215	4
G144-0161	1	G165-0100	2	G235-0007	3	G290-0295	4
G144-0162	1	G165-0107	2	G235-0025	3	G290-0390	4
G144-0222	1	G165-0108	2	G235-0032	3	G290-0520	4
G144-0223	1	G165-0109	2	G235-0050	3	G290-0650	4
G144-0224	1	G165-0110	2	G235-0058	3	G290-0860	4
G144-0225	1	G165-0150	2	G235-0059	3	G290-0975	4
G144-0226	1	G165-0159	2	G235-0060	3	G290-1100	4
G144-0303	1	G165-0160	2	G235-0100	3	G295-0001	4
G144-0304	1	G165-0161	2	G235-0107	3	G295-0002	4
G144-0305	1	G165-0162	2	G235-0108	3	G295-0025	4
G144-0306	1	G165-0215	2	G235-0109	3	G295-0050	4
G144-0307	1	G165-0222	2	G235-0150	3	G295-0100	4
G144-0308	1	G165-0223	2	G235-0159	3	G295-0150	4
G144-0398	1	G165-0224	2	G235-0160	3	G295-0215	4
G144-0399	1	G165-0225	2	G235-0161	3	G295-0295	4
G144-0400	1	G165-0295	2	G235-0215	3	G295-0390	4
G144-0401	1	G165-0303	2	G235-0222	3	G295-0520	4
G144-0402	1	G165-0304	2	G235-0223	3	G295-0650	4
G144-0403	1	G165-0305	2	G235-0224	3	G295-0860	4
G144-0531	1	G165-0306	2	G235-0295	3	G335-0050	1
G144-0532	1	G165-0307	2	G235-0303	3	G335-0100	1
G144-0533	1	G165-0390	2	G235-0304	3	G335-0150	1
G144-0534	1	G165-0398	2	G235-0305	3	G335-0215	1
G144-0535	1	G165-0399	2	G235-0306	3	G335-0295	1
G144-0536	1	G165-0400	2	G235-0390	3	G335-0390	1
G144-0662	1	G165-0401	2	G235-0398	3	G355-0001	4
G144-0663	1	G165-0402	2	G235-0399	3	G355-0002	4
G144-0664	1	G165-0520	2	G235-0400	3	G355-0025	4
G144-0665	1	G165-0531	2	G235-0401	3	G355-0050	4
G144-0666	1	G165-0532	2	G235-0402	3	G355-0100	4
G144-0667	1	G165-0533	2	G235-0520	3	G355-0150	4
G144-0668	1	G165-0534	2	G235-0531	3	G355-0215	4
G144-0790	1	G165-0535	2	G235-0532	3	G355-0295	4
G144-0870	1	G165-0536	2	G235-0533	3	G355-0390	4
G144-0871	1	G165-0650	2	G235-0534	3	G375-0001	4
G144-0872	1	G165-0662	2	G235-0535	3	G375-0002	4
G144-0873	1	G165-0663	2	G235-0536	3	G375-0025	4
G144-0874	1	G165-0664	2	G235-0650	3	G375-0050	4
G144-0875	1	G165-0665	2	G235-0662	3	G375-0100	4
G144-0876	1	G165-0666	2	G235-0663	3	G375-0150	4
G144-1109	1	G165-0667	2	G235-0664	3	G375-0215	4
G144-1111	1	G165-0668	2	G235-0860	3	G375-0295	4
G155-0001	1	G165-0860	2	G235-0870	3	G375-0390	4
G155-0002	1	G165-0870	2	G235-0871	3	G375-0520	4
G155-0025	1	G165-0871	2	G235-0872	3	G396-0001	4
G155-0050	1	G165-0872	2	G235-0975	3	G396-0002	4
G155-0100	1	G165-0873	2	G235-1100	3	G396-0025	4
G155-0150	1	G165-0874	2	G254-0001	3	G396-0050	4
G155-0215	1	G165-0875	2	G254-0002	3	G396-0100	4
G155-0295	1	G165-1100	2	G254-0025	3	G396-0150	4

PART NO.	PG #
G396-0215	4
G396-0295	4
G396-0390	4
G396-0520	4
G396-0650	4
G396-0860	4
G396-1100	4
G460-0001	5
G460-0002	5
G460-0007	5
G460-0025	5
G460-0032	5
G460-0033	5
G460-0050	5
G460-0056	5
G460-0057	5
G460-0058	5
G460-0059	5
G460-0060	5
G460-0100	5
G460-0105	5
G460-0106	5
G460-0107	5
G460-0108	5
G460-0109	5
G460-0116	5
G460-0117	5
G460-0118	5
G460-0150	5
G460-0157	5
G460-0158	5
G460-0159	5
G460-0160	5
G460-0161	5
G460-0162	5
G460-0169	5
G460-0170	5
G460-0171	5
G460-0180	5
G460-0181	5
G460-0182	5
G460-0215	5
G460-0221	5
G460-0222	5
G460-0223	5
G460-0224	5
G460-0225	5
G460-0233	5
G460-0234	5
G460-0235	5
G460-0236	5
G460-0237	5
G460-0245	5
G460-0246	5
G460-0247	5
G460-0248	5
G460-0256	5
G460-0257	5
G460-0258	5
G460-0259	5
G460-0295	5
G460-0302	5
G460-0303	5
G460-0304	5
G460-0305	5
G460-0306	5

PART NO.	PG #
G460-0307	5
G460-0315	5
G460-0316	5
G460-0317	5
G460-0318	5
G460-0319	5
G460-0328	5
G460-0329	5
G460-0330	5
G460-0331	5
G460-0332	5
G460-0339	5
G460-0340	5
G460-0342	5
G460-0343	5
G460-0350	5
G460-0351	5
G460-0352	6
G460-0353	6
G460-0354	6
G460-0390	5
G460-0397	6
G460-0398	6
G460-0399	6
G460-0400	6
G460-0401	6
G460-0402	6
G460-0403	6
G460-0413	6
G460-0414	6
G460-0415	6
G460-0416	6
G460-0417	6
G460-0418	6
G460-0429	6
G460-0430	6
G460-0431	6
G460-0432	6
G460-0444	6
G460-0447	6
G460-0457	6
G460-0470	6
G460-0520	5
G460-0531	6
G460-0532	6
G460-0533	6
G460-0534	6
G460-0535	6
G460-0536	6
G460-0548	6
G460-0549	6
G460-0650	5
G460-0662	6
G460-0663	6
G460-0664	6
G460-0665	6
G460-0666	6
G460-0667	6
G460-0668	6
G460-0860	5
G460-0870	6
G460-0871	6
G460-0872	6
G460-0873	6
G460-0874	6

PART NO.	PG #
G460-0875	6
G460-0975	5
G460-1100	5
G486-0050	6
G486-0100	6
G486-0150	6
G486-0215	6
G486-0295	6
G486-0390	6
G657-0001	6
G657-0002	6
G657-0025	6
G657-0050	6
G657-0100	6
G657-0150	6
G657-0215	6
G657-0295	6
G657-0390	6
G657-0520	6
G657-0650	6
G657-0860	6
GI05	9
GI07	9
GI10	9
GI12	9
GI15	9
GI20	9
H105	11
H107	11
H110	11
H112	11
H115	11
H120	11
H305	11
H307	11
H310	11
H312	11
H315	11
H320	11
M101	11
M102	11
M103	11
M105	11
M107	11
M110	11
M112	11
M115	11
M120	11
M125	11
M130	11
M140	11
M301	11
M302	11
M303	11
M305	11
M307	11
M310	11
M312	11
M315	11
M320	11
M325	11

PART NO.	PG #
M330	11
M340	11



COPPER FITTINGS

VOLUME V



Quality
Products *for*
the Plumbing
Professional

Wrot/ACR Solder Fittings 1-8

Forged Brass/Cast Brass Pressure Fittings..... 9-12

Wrot DWV Solder Fittings..... 13-14

Cast DWV Solder Fittings..... 15-18

Cast Brass Flanges 19

Product Index..... 20

Part Number Index..... 21-26

Male Adapter

C x M



JSC #	LTC #	SIZE	CTN QTY	MSTR QTY
C75311	K151010001	1/8"	25	3000
C75312	K151010002	1/4"	25	1600
C75313	K151010025	3/8"	25	1000
C75314	K151010050	1/2"	25	600
C75315	K151010100	3/4"	25	250
C75316	K151010150	1"	10	150
C75317	K151010215	1 1/4"	110	110
C75318	K151010295	1 1/2"	65	65
C75319	K151010390	2"	38	38
C75320	K151010520	2 1/2"	48	48
C75321	K151010650	3"	36	36
C75322	K151010860	4"	12	12
C75323	K151010024	1/8" x 1/4"	25	2000
C75324	K151010007	1/4" x 1/8"	25	2000
C75325	K151010006	1/4" x 3/8"	25	750
C75326	K151010005	1/4" x 1/2"	25	600
C75327	K151010032	3/8" x 1/4"	25	750
C75328	K151010031	3/8" x 1/2"	25	500
C75329	K151010059	1/2" x 1/4"	25	1000
C75330	K151010058	1/2" x 3/8"	25	800
C75331	K151010057	1/2" x 3/4"	25	250
C75332	K151010056	1/2" x 1"	10	150
C75333	K151010093	5/8" x 1/2"	25	250
C75334	K151010092	5/8" x 3/4"	25	250
C75335	K151010107	3/4" x 1/2"	25	250
C75336	K151010106	3/4" x 1"	10	150
C75337	K151010160	1" x 1/2"	10	180
C75338	K151010159	1" x 3/4"	10	150
C75339	K151010158	1" x 1 1/4"	85	85
C75340	K151010157	1" x 1 1/2"	65	65
C75341	K151010223	1 1/4" x 3/4"	130	130
C75342	K151010222	1 1/4" x 1"	120	120
C75343	K151010221	1 1/4" x 1 1/2"	90	90
C75345	K151010304	1 1/2" x 1"	120	120
C75346	K151010303	1 1/2" x 1 1/4"	60	60
C75347	K151010302	1 1/2" x 2"	50	50
C75348	K151010399	2" x 1 1/4"	48	48
C75349	K151010398	2" x 1 1/2"	48	48
C75350	K151010531	2 1/2" x 2"	36	36

Female Adapter

C x F



JSC #	LTC #	SIZE	CTN QTY	MSTR QTY
C75111	K151050001	1/8"	25	1500
C75112	K151050002	1/4"	25	1000
C75113	K151050025	3/8"	25	800
C75114	K151050050	1/2"	25	450
C75115	K151050100	3/4"	25	200
C75116	K151050150	1"	10	140
C75117	K151050215	1 1/4"	80	80
C75118	K151050295	1 1/2"	60	60
C75119	K151050390	2"	36	36
C75120	K151050520	2 1/2"	48	48
C75121	K151050650	3"	28	28
C75122	K151050024	1/8" x 1/4"	25	1000
C75123	K151050006	1/4" x 3/8"	25	900
C75124	K151050032	3/8" x 1/4"	25	750
C75125	K151050031	3/8" x 1/2"	25	500
C75126	K151050060	1/2" x 1/8"	25	500
C75127	K151050059	1/2" x 1/4"	50	500
C75128	K151050058	1/2" x 3/8"	25	800
C75129	K151050057	1/2" x 3/4"	25	300
C75130	K151050056	1/2" x 1"	10	160
C75131	K151050093	5/8" x 1/2"	25	300
C75132	K151050092	5/8" x 3/4"	25	250
C75133	K151050107	3/4" x 1/2"	25	300
C75134	K151050106	3/4" x 1"	10	140
C75135	K151050160	1" x 1/2"	10	150
C75136	K151050159	1" x 3/4"	10	150
C75137	K151050158	1" x 1 1/4"	85	85
C75138	K151050223	1 1/4" x 3/4"	120	120
C75139	K151050222	1 1/4" x 1"	120	120
C75140	K151050221	1 1/4" x 1 1/2"	65	65
C75141	K151050303	1 1/2" x 1 1/4"	70	70
C75142	K151050302	1 1/2" x 2"	60	60
C75494	K151050398	2" x 1 1/2"	40	40

Fitting Male Adapter

Ftg x M



JSC #	LTC #	SIZE	CTN QTY	MSTR QTY
C75351	K151140002	1/4"	25	1000
C75352	K151140025	3/8"	25	800
C75353	K151140050	1/2"	25	500
C75354	K151140057	1/2" x 3/4"	25	250
C75355	K151140100	3/4"	25	250
C75356	K151140150	1"	10	130
C75357	K151140215	1 1/4"	80	80
C75358	K151140295	1 1/2"	50	50
C75359	K151140390	2"	38	38

Fitting Female Adapter

Ftg x F



JSC #	LTC #	SIZE	CTN QTY	MSTR QTY
C75392	K151150002	1/4"	25	1500
C75393	K151150025	3/8"	25	800
C75394	K151150050	1/2"	25	500
C75395	K151150100	3/4"	25	250
C75396	K151150150	1"	10	140
C75397	K151150215	1 1/4"	85	85
C75398	K151150295	1 1/2"	80	80
C75399	K151150390	2"	40	40
C75400	K151150058	1/2" x 3/8"	25	700
C75401	K151150057	1/2" x 3/4"	25	300

Flush Bushing

Ftg x F

JSC #	LTC #	SIZE	CTN QTY	MSTR QTY
C75375	K151420060	1/2" x 1/8"	25	1500

Coupling (Socket) w/Rolled Tube Stop

C x C



JSC #	LTC #	SIZE	CTN QTY	MSTR QTY
C75000	K151650001	1/8"	25	3000
C75001	K151650002	1/4"	25	2000
C75566	K151650015	5/16" OD	25	3000
C75002	K151650025	3/8"	25	1200
C75003	K151650050	1/2"	25	800
C75004	K151650090	5/8"	25	400
C75005	K151650100	3/4"	25	300
C75567	K151651520	7/8"	25	300
C75006	K151650150	1"	10	150
C75007	K151650215	1 1/4"	100	100
C75008	K151650295	1 1/2"	60	60
C75009	K151650390	2"	40	40
C75010	K151650520	2 1/2"	50	50
C75011	K151650650	3"	30	30
C75012	K151650780	3 1/2"	18	18
C75013	K151650860	4"	12	12
C75476	K151650975	5"	6	6
C75477	K151651100	6"	3	3
C75478	K151651225	8"	1	1

Reducing Coupling

C x C



JSC #	LTC #	SIZE	CTN QTY	MSTR QTY
C75069	K151650007	1/4" x 1/8"	25	2000
C75516	K151650008	1/4" OD x 3/16" OD	25	2000
C75070	K151650033	3/8" x 1/8"	25	800
C75071	K151650032	3/8" x 1/4"	25	800
C75072	K151650060	1/2" x 1/8"	25	800
C75073	K151650059	1/2" x 1/4"	25	800
C75074	K151650058	1/2" x 3/8"	25	800
C75075	K151650095	5/8" x 1/4"	25	500
C75076	K151650094	5/8" x 3/8"	25	500
C75077	K151650093	5/8" x 1/2"	25	500
C75078	K151650109	3/4" x 1/4"	25	400
C75079	K151650108	3/4" x 3/8"	25	400
C75080	K151650107	3/4" x 1/2"	25	350
C75081	K151650149	3/4" x 5/8"	25	350
C75517	K151650161	1" x 3/8"	10	200
C75082	K151650160	1" x 1/2"	10	200
C75083	K151651498	1" x 5/8"	10	180
C75084	K151650159	1" x 3/4"	10	160
C75085	K151650224	1 1/4" x 1/2"	100	100
C75086	K151650223	1 1/4" x 3/4"	100	100
C75087	K151650222	1 1/4" x 1"	100	100
C75088	K151650306	1 1/2" x 1/2"	100	100
C75089	K151650305	1 1/2" x 3/4"	100	100
C75090	K151650304	1 1/2" x 1"	100	100
C75091	K151650303	1 1/2" x 1 1/4"	100	100
C75092	K151650402	2" x 1/2"	50	50
C75093	K151650401	2" x 3/4"	50	50
C75094	K151650400	2" x 1"	50	50
C75095	K151650399	2" x 1 1/4"	50	50
C75096	K151650398	2" x 1 1/2"	50	50
C75097	K151650534	2 1/2" x 1"	30	30
C75098	K151650533	2 1/2" x 1 1/4"	30	30
C75099	K151650532	2 1/2" x 1 1/2"	30	30
C75100	K151650531	2 1/2" x 2"	30	30
C75101	K151650664	3" x 1 1/2"	20	20
C75102	K151650663	3" x 2"	20	20
C75103	K151650662	3" x 2 1/2"	15	15
C75518	K151650790	3 1/2" x 3"	25	25
C75104	K151650874	4" x 1 1/4"	20	20
C75105	K151650873	4" x 1 1/2"	20	20
C75106	K151650872	4" x 2"	18	18
C75107	K151650871	4" x 2 1/2"	18	18
C75108	K151650870	4" x 3"	18	18
C75109	K151651111	6" x 3"	4	4
C75110	K151651109	6" x 4"	4	4

Coupling (Socket) w/Dimple Tube Stop

C x C



JSC #	LTC #	SIZE	CTN QTY	MSTR QTY
C75550	K151700001	1/8"	25	3000
C75551	K151700002	1/4"	25	2000
C75552	K151700015	5/16" OD	25	1500
C75553	K151700025	3/8"	25	1200
C75554	K151700050	1/2"	25	800
C75555	K151700090	5/8"	25	400
C75556	K151700100	3/4"	25	300
C75557	K151700150	1"	10	150
C75558	K151700215	1 1/4"	100	100
C75559	K151700295	1 1/2"	60	60
C75580	K151700390	2"	40	40
C75581	K151700520	2 1/2"	50	50
C75582	K151700650	3"	30	30
C75583	K151700780	3 1/2"	25	25
C75564	K151700860	4"	12	12
C75565	K151700975	5"	6	6
C75586	K151701100	6"	4	4
C75587	K151701225	8"	2	2

Coupling (Socket) Less Tube Stop

C x C



JSC #	LTC #	SIZE	CTN QTY	MSTR QTY
C75412	K151720001	1/8"	25	3000
C75413	K151720002	1/4"	25	2000
C75414	K151720025	3/8"	25	1200
C75415	K151720050	1/2"	25	800
C75519	K151720090	5/8"	25	400
C75416	K151720100	3/4"	25	300
C75417	K151720150	1"	10	150
C75418	K151720215	1 1/4"	100	100
C75419	K151720295	1 1/2"	60	60
C75420	K151720390	2"	40	40
C75421	K151720520	2 1/2"	50	50
C75422	K151720650	3"	30	30
C75423	K151720860	4"	12	12
C75424	K151720975	5"	6	6

Crossover Coupling

C x C



JSC #	LTC #	SIZE	CTN QTY	MSTR QTY
C75548	K151670050	1/2"	10	180

Cap



JSC #	LTC #	SIZE	CTN QTY	MSTR QTY
C75055	K151540001	1/8"	25	3300
C75056	K151540002	1/4"	25	3000
C75057	K151540025	3/8"	25	2500
C75058	K151540050	1/2"	25	1400
C75059	K151540090	5/8"	25	850
C75060	K151540100	3/4"	25	500
C75061	K151540150	1"	10	300
C75062	K151540215	1 1/4"	200	200
C75063	K151540295	1 1/2"	140	140
C75064	K151540390	2"	60	60
C75065	K151540520	2 1/2"	30	30
C75066	K151540650	3"	20	20
C75067	K151540860	4"	25	25
C75068	K151541100	6"	5	5

90° Short Turn Ell

C x C



JSC #	LTC #	SIZE	CTN QTY	MSTR QTY
C75014	K152350001	1/8"	25	3000
C75015	K152350002	1/4"	25	1200
C75016	K152350025	3/8"	25	1000
C75030	K152350032	3/8" x 1/4"	25	800
C75017	K152350050	1/2"	100	800
C75031	K152350059	1/2" x 1/4"	25	500
C75032	K152350058	1/2" x 3/8"	25	500
C75018	K152350090	5/8"	25	300
C75520	K152350093	5/8" x 1/2"	25	300
C75019	K152350100	3/4"	25	250
C75033	K152350107	3/4" x 1/2"	25	200
C75521	K152351520	7/8"	25	200
C75020	K152350150	1"	10	100
C75034	K152350160	1" x 1/2"	10	80
C75035	K152350159	1" x 3/4"	10	80
C75021	K152350215	1 1/4"	50	50
C75522	K152350223	1 1/4" x 3/4"	50	50
C75036	K152350222	1 1/4" x 1"	50	50
C75022	K152350295	1 1/2"	35	35
C75037	K152350303	1 1/2" x 1 1/4"	35	35
C75023	K152350390	2"	17	17
C75038	K152350398	2" x 1 1/2"	17	17
C75024	K152350520	2 1/2"	20	20
C75025	K152350650	3"	13	13
C75523	K152350780	3 1/2"	25	25
C75026	K152350860	4"	6	6
C75027	K152350975	5"	2	2
C75028	K152351100	6"	1	1
C75029	K152351225	8"	1	1

90° Intermediate Turn Ell

C x C

JSC #	LTC #	SIZE	CTN QTY	MSTR QTY
C75530	K152380025	3/8"	25	750
C75531	K152380090	5/8"	25	200
C75532	K152380100	3/4"	25	200
C75533	K152380150	1"	20	100

90° Long Turn Ell

C x C



JSC #	LTC #	SIZE	CTN QTY	MSTR QTY
C75481	K152420001	1/8"	25	2000
C75482	K152420002	1/4"	25	1200
C75540	K152420015	5/16" OD	25	1600
C75483	K152420025	3/8"	25	750
C75484	K152420050	1/2"	25	350
C75485	K152420090	5/8"	25	200
C75541	K152420093	5/8" x 1/2"	25	200
C75486	K152420100	3/4"	10	120
C75542	K152420149	3/4" x 5/8"	25	125
C75487	K152420150	1"	10	60
C75493	K152420159	1" x 3/4"	10	100
C75488	K152420215	1 1/4"	35	35
C75489	K152420295	1 1/2"	25	25
C75543	K152420304	1 1/2" x 1"	25	25
C75490	K152420390	2"	12	12
C75491	K152420520	2 1/2"	16	16
C75492	K152420650	3"	8	8
C75544	K152420860	4"	6	6

90° Short Turn Street Ell

Ftg x C



JSC #	LTC #	SIZE	CTN QTY	MSTR QTY
C75377	K152540002	1/4"	25	1200
C75378	K152540025	3/8"	25	1000
C75379	K152540050	1/2"	25	500
C75380	K152540090	5/8"	25	300
C75381	K152540100	3/4"	25	200
C75382	K152540150	1"	10	100
C75383	K152540215	1 1/4"	50	50
C75384	K152540295	1 1/2"	35	35
C75385	K152540390	2"	17	17
C75386	K152540520	2 1/2"	20	20
C75387	K152540650	3"	13	13
C75388	K152540860	4"	6	6

90° Short Turn Street Ell

Ftg x Ftg

JSC #	LTC #	SIZE	CTN QTY	MSTR QTY
C75534	K152670025	3/8"	25	750
C75535	K152670050	1/2"	25	500
C75536	K152670100	3/4"	25	250
C75537	K152670215	1 1/4"	35	35

90° Long Turn Street Ell

Ftg x C



JSC #	LTC #	SIZE	CTN QTY	MSTR QTY
C75402	K152720001	1/8"	25	2000
C75403	K152720002	1/4"	25	1200
C75404	K152720025	3/8"	25	750
C75405	K152720050	1/2"	25	350
C75406	K152720090	5/8"	25	200
C75407	K152720100	3/4"	10	120
C75408	K152720150	1"	10	60
C75409	K152720215	1 1/4"	35	35
C75410	K152720295	1 1/2"	25	25
C75411	K152720390	2"	12	12
C75479	K152720520	2 1/2"	16	16
C75546	K152720860	4"	6	6

45° Ell

C x C



JSC #	LTC #	SIZE	CTN QTY	MSTR QTY
C75039	K152900001	1/8"	25	2000
C75040	K152900002	1/4"	25	2000
C75041	K152900025	3/8"	25	800
C75042	K152900050	1/2"	25	500
C75043	K152900090	5/8"	25	300
C75044	K152900100	3/4"	25	200
C75045	K152900150	1"	10	100
C75046	K152900215	1 1/4"	60	60
C75047	K152900295	1 1/2"	40	40
C75048	K152900390	2"	18	18
C75049	K152900520	2 1/2"	20	20
C75050	K152900650	3"	15	15
C75051	K152900860	4"	6	6
C75052	K152900975	5"	4	4
C75053	K152901100	6"	2	2
C75054	K152901225	8"	1	1

45° Street Ell

Ftg x C



JSC #	LTC #	SIZE	CTN QTY	MSTR QTY
C75463	K152950002	1/4"	25	2000
C75464	K152950025	3/8"	25	800
C75465	K152950050	1/2"	25	500
C75466	K152950090	5/8"	25	300
C75467	K152950100	3/4"	25	200
C75468	K152950150	1"	10	100
C75469	K152950215	1 1/4"	60	60
C75470	K152950295	1 1/2"	40	40
C75471	K152950390	2"	18	18
C75472	K152950520	2 1/2"	20	20
C75473	K152950650	3"	15	15
C75474	K152950860	4"	6	6
C75475	K152951100	6"	2	2

Fitting Plug



JSC #	LTC #	SIZE	CTN QTY	MSTR QTY
C75525	K153960050	1/2"	25	1400
C75527	K153960150	1"	10	300

Suction Line P-Trap

C x C



LTC #	SIZE	CTN QTY	MSTR QTY
K155330050	1/2"	5	60
K155330090	5/8"	5	60
K155330100	3/4"	5	40
K155330150	1"	3	15
K155330215	1 1/4"	2	10
K155330295	1 1/2"	2	6
K155330390	2"	1	4

Flush Bushing

Ftg x C



JSC #	LTC #	SIZE	CTN QTY	MSTR QTY
C75360	K151400007	1/4" x 1/8"	25	3300
C75361	K151400032	3/8" x 1/4"	25	2500
C75363	K151400058	1/2" x 3/8"	25	1500
C75362	K151400059	1/2" x 1/4"	25	1500
C75365	K151400109	3/4" x 1/4"	25	700
C75568	K151400108	3/4" x 3/8"	25	700
C75366	K151400107	3/4" x 1/2"	25	700
C75367	K151400149	3/4" x 5/8"	25	500
C75368	K151400160	1" x 1/2"	10	320
C75369	K151401498	1" x 5/8"	10	300
C75370	K151400159	1" x 3/4"	10	400
C75371	K151400223	1 1/4" x 3/4"	200	200
C75372	K151400222	1 1/4" x 1"	200	200
C75373	K151400303	1 1/2" x 1 1/4"	140	140
C75374	K151400398	2" x 1 1/2"	60	60

Fitting Reducer

Ftg x C



JSC #	LTC #	SIZE	CTN QTY	MSTR QTY
C75425	K154100007	1/4" x 1/8"	25	3300
C75426	K154100033	3/8" x 1/8"	25	1200
C75427	K154100032	3/8" x 1/4"	25	1200
C75428	K154100059	1/2" x 1/4"	25	1000
C75429	K154100058	1/2" x 3/8"	25	1000
C75430	K154100094	5/8" x 3/8"	25	500
C75431	K154100093	5/8" x 1/2"	25	500
C75560	K154100095	5/8" x 1/4"	25	500
C75432	K154100109	3/4" x 1/4"	25	400
C75433	K154100108	3/4" x 3/8"	25	400
C75434	K154100107	3/4" x 1/2"	25	400
C75435	K154100149	3/4" x 5/8"	25	400
C75436	K154100161	1" x 3/8"	10	200
C75437	K154100160	1" x 1/2"	10	200
C75438	K154101498	1" x 5/8"	10	200
C75439	K154100159	1" x 3/4"	10	160
C75440	K154100224	1 1/4" x 1/2"	100	100
C75441	K154100223	1 1/4" x 3/4"	100	100
C75442	K154100222	1 1/4" x 1"	100	100
C75443	K154100306	1 1/2" x 1/2"	100	100
C75444	K154100305	1 1/2" x 3/4"	100	100
C75445	K154100304	1 1/2" x 1"	100	100
C75446	K154100303	1 1/2" x 1 1/4"	100	100
C75447	K154100402	2" x 1/2"	50	50
C75448	K154100401	2" x 3/4"	50	50
C75449	K154100400	2" x 1"	50	50
C75450	K154100399	2" x 1 1/4"	50	50
C75451	K154100398	2" x 1 1/2"	50	50
C75452	K154100534	2 1/2" x 1"	30	30
C75453	K154100533	2 1/2" x 1 1/4"	30	30
C75454	K154100532	2 1/2" x 1 1/2"	30	30
C75455	K154100531	2 1/2" x 2"	30	30
C75456	K154100665	3" x 1 1/4"	20	20
C75457	K154100664	3" x 1 1/2"	20	20
C75458	K154100663	3" x 2"	20	20
C75459	K154100662	3" x 2 1/2"	15	15
C75561	K154100874	4" x 1 1/4"	20	20
C75460	K154100872	4" x 2"	18	18
C75461	K154100871	4" x 2 1/2"	18	18
C75462	K154100870	4" x 3"	18	18
C75562	K154100869	4" x 3 1/2"	15	15
C75563	K154100983	5" x 4"	1	1

Union

C x C



JSC #	LTC #	SIZE	CTN QTY	MSTR QTY
C75500	K156570002	1/4"	25	500
C75501	K156570025	3/8"	25	400
C75502	K156570050	1/2"	25	200
C75510	K126570090	5/8"	25	200
C75503	K156570100	3/4"	25	100
C75504	K156570150	1"	10	70
C75505	K126570215	1 1/4"	50	50
C75506	K126570295	1 1/2"	30	30
C75507	K126570390	2"	18	18
C75508	K126570520	2 1/2"	8	8
C75509	K126570650	3"	6	6

U-Type Strap



LTC #	SIZE	CTN QTY	MSTR QTY
K159470001	1/8"	25	2000
K159470002	1/4"	100	1000
K159470025	3/8"	25	1300
K159470050	1/2"	25	1000
K159470090	5/8"	25	500
K159470100	3/4"	25	600
K159470150	1"	10	350
K159470215	1 1/4"	-	350
K159470295	1 1/2"	-	300
K159470390	2"	-	300

Tee

C x C x C



JSC #	LTC #	SIZE	CTN QTY	MSTR QTY
C75143	K154600001	1/8"	25	2000
C75159	K154600024	1/8" x 1/8" x 1/4"	25	2000
C75144	K154600002	1/4"	25	1300
C75162	K154600007	1/4" x 1/4" x 1/8"	25	1300
C75163	K154600006	1/4" x 1/4" x 3/8"	25	1300
C75164	K154600005	1/4" x 1/4" x 1/2"	50	500
C75160	K154600013	1/4" x 1/8" x 1/8"	25	1500
C75161	K154600012	1/4" x 1/8" x 1/4"	25	1300
C75145	K154600025	3/8"	25	600
C75165	K154600046	3/8" x 1/8" x 3/8"	25	600
C75166	K154600041	3/8" x 1/4" x 1/4"	25	500
C75167	K154600033	3/8" x 3/8" x 1/8"	25	600
C75168	K154600032	3/8" x 3/8" x 1/4"	25	600
C75169	K154600031	3/8" x 3/8" x 1/2"	25	350
C75146	K154600050	1/2"	50	500
C75170	K154600075	1/2" x 1/4" x 1/2"	25	400
C75171	K154600068	1/2" x 3/8" x 1/4"	25	400
C75172	K154600067	1/2" x 3/8" x 3/8"	25	400
C75173	K154600066	1/2" x 3/8" x 1/2"	25	350
C75174	K154600060	1/2" x 1/2" x 1/8"	25	400
C75175	K154600059	1/2" x 1/2" x 1/4"	25	400
C75176	K154600058	1/2" x 1/2" x 3/8"	25	400
C75570	K154600087	1/2" x 1/2" x 5/8"	10	180
C75177	K154600057	1/2" x 1/2" x 3/4"	10	180
C75178	K154600056	1/2" x 1/2" x 1"	10	70
C75147	K154600090	5/8"	25	200
C75179	K154600098	5/8" x 1/2" x 1/2"	25	200
C75571	K154600095	5/8" x 5/8" x 1/4"	25	200
C75181	K154600092	5/8" x 5/8" x 3/4"	25	200
C75148	K154600100	3/4"	20	160
C75572	K154600127	3/4" x 3/8" x 1/2"	10	170
C75182	K154600118	3/4" x 1/2" x 1/2"	10	180
C75183	K154600117	3/4" x 1/2" x 3/4"	10	120
C75184	K154600109	3/4" x 3/4" x 1/4"	10	170
C75185	K154600108	3/4" x 3/4" x 3/8"	10	170
C75186	K154600107	3/4" x 3/4" x 1/2"	10	170
C75187	K154600149	3/4" x 3/4" x 5/8"	10	150
C75188	K154600106	3/4" x 3/4" x 1"	10	80
C75149	K154600150	1"	10	60
C75195	K154600161	1" x 1" x 3/8"	10	100
C75196	K154600160	1" x 1" x 1/2"	10	100
C75198	K154600159	1" x 1" x 3/4"	10	60
C75199	K154600158	1" x 1" x 1 1/4"	35	35
C75200	K154600157	1" x 1" x 1 1/2"	25	25
C75192	K154600171	1" x 3/4" x 1/2"	10	90
C75193	K154600170	1" x 3/4" x 3/4"	10	60
C75194	K154600169	1" x 3/4" x 1"	10	60
C75189	K154600182	1" x 1/2" x 1/2"	10	100
C75190	K154600181	1" x 1/2" x 3/4"	10	80
C75191	K154600180	1" x 1/2" x 1"	10	60

JSC #	LTC #	SIZE	CTN QTY	MSTR QTY
C75197	K154601498	1" x 1" x 5/8"	10	70
C75150	K154600215	1 1/4"	35	35
C75201	K154600257	1 1/4" x 1/2" x 1/2"	75	75
C75202	K154600256	1 1/4" x 1/2" x 1 1/4"	35	35
C75203	K154600248	1 1/4" x 3/4" x 1/2"	50	50
C75204	K154600247	1 1/4" x 3/4" x 3/4"	50	50
C75205	K154600246	1 1/4" x 3/4" x 1"	45	45
C75206	K154600245	1 1/4" x 3/4" x 1 1/4"	35	35
C75207	K154600237	1 1/4" x 1" x 1/2"	60	60
C75208	K154600236	1 1/4" x 1" x 3/4"	50	50
C75209	K154600235	1 1/4" x 1" x 1"	50	50
C75210	K154600234	1 1/4" x 1" x 1 1/4"	30	30
C75211	K154600224	1 1/4" x 1 1/4" x 1/2"	50	50
C75212	K154600223	1 1/4" x 1 1/4" x 3/4"	50	50
C75213	K154600222	1 1/4" x 1 1/4" x 1"	40	40
C75214	K154600221	1 1/4" x 1 1/4" x 1 1/2"	20	20
C75215	K154600220	1 1/4" x 1 1/4" x 2"	10	10
C75151	K154600295	1 1/2"	20	20
C75233	K154600306	1 1/2" x 1 1/2" x 1/2"	40	40
C75234	K154600305	1 1/2" x 1 1/2" x 3/4"	35	35
C75235	K154600304	1 1/2" x 1 1/2" x 1"	35	35
C75236	K154600303	1 1/2" x 1 1/2" x 1 1/4"	25	25
C75237	K154600302	1 1/2" x 1 1/2" x 2"	10	10
C75228	K154600319	1 1/2" x 1 1/4" x 1/2"	40	40
C75229	K154600318	1 1/2" x 1 1/4" x 3/4"	40	40
C75230	K154600317	1 1/2" x 1 1/4" x 1"	30	30
C75231	K154600316	1 1/2" x 1 1/4" x 1 1/4"	30	30
C75232	K154600315	1 1/2" x 1 1/4" x 1 1/2"	20	20
C75223	K154600332	1 1/2" x 1" x 1/2"	40	40
C75225	K154600331	1 1/2" x 1" x 3/4"	40	40
C75224	K154600330	1 1/2" x 1" x 1"	35	35
C75226	K154600329	1 1/2" x 1" x 1 1/4"	30	30
C75227	K154600328	1 1/2" x 1" x 1 1/2"	20	20
C75218	K154600343	1 1/2" x 3/4" x 1/2"	40	40
C75219	K154600342	1 1/2" x 3/4" x 3/4"	30	30
C75220	K154600341	1 1/2" x 3/4" x 1"	40	40
C75221	K154600340	1 1/2" x 3/4" x 1 1/4"	30	30
C75222	K154600339	1 1/2" x 3/4" x 1 1/2"	20	20
C75216	K154600352	1 1/2" x 1/2" x 1"	40	40
C75217	K154600350	1 1/2" x 1/2" x 1 1/2"	20	20
C75152	K154600390	2"	10	10
C75254	K154600402	2" x 2" x 1/2"	20	20
C75255	K154600401	2" x 2" x 3/4"	20	20
C75256	K154600400	2" x 2" x 1"	18	18
C75257	K154600399	2" x 2" x 1 1/4"	15	15
C75258	K154600398	2" x 2" x 1 1/2"	10	10
C75259	K154600397	2" x 2" x 2 1/2"	15	15
C75248	K154600418	2" x 1 1/2" x 1/2"	20	20
C75249	K154600417	2" x 1 1/2" x 3/4"	20	20
C75250	K154600416	2" x 1 1/2" x 1"	20	20
C75251	K154600415	2" x 1 1/2" x 1 1/4"	10	10
C75252	K154600414	2" x 1 1/2" x 1 1/2"	10	10
C75253	K154600413	2" x 1 1/2" x 2"	10	10
C75243	K154600433	2" x 1 1/4" x 3/4"	20	20
C75244	K154600432	2" x 1 1/4" x 1"	20	20
C75245	K154600431	2" x 1 1/4" x 1 1/4"	15	15
C75246	K154600430	2" x 1 1/4" x 1 1/2"	15	15

JSC #	LTC #	SIZE	CTN QTY	MSTR QTY
C75247	K154600429	2" x 1 1/4" x 2"	10	10
C75240	K154600447	2" x 1" x 1"	20	20
C75241	K154600445	2" x 1" x 1 1/2"	15	15
C75242	K154600444	2" x 1" x 2"	15	15
C75238	K154600470	2" x 1/2" x 2"	15	15
C75239	K154600457	2" x 3/4" x 2"	10	10
C75153	K154600520	2 1/2"	15	15
C75260	K154600608	2 1/2" x 3/4" x 2 1/2"	15	15
C75261	K154600595	2 1/2" x 1" x 2 1/2"	15	15
C75262	K154600583	2 1/2" x 1 1/4" x 1 1/4"	20	20
C75263	K154600580	2 1/2" x 1 1/4" x 2 1/2"	15	15
C75573	K154600566	2 1/2" x 1 1/2" x 1 1/2"	15	15
C75574	K154600565	2 1/2" x 1 1/2" x 2"	15	15
C75264	K154600564	2 1/2" x 1 1/2" x 2 1/2"	15	15
C75265	K154600554	2 1/2" x 2" x 1/2"	20	20
C75266	K154600553	2 1/2" x 2" x 3/4"	20	20
C75267	K154600552	2 1/2" x 2" x 1"	20	20
C75268	K154600551	2 1/2" x 2" x 1 1/4"	20	20
C75269	K154600550	2 1/2" x 2" x 1 1/2"	20	20
C75270	K154600549	2 1/2" x 2" x 2"	15	15
C75271	K154600548	2 1/2" x 2" x 2 1/2"	15	15
C75272	K154600536	2 1/2" x 2 1/2" x 1/2"	25	25
C75273	K154600535	2 1/2" x 2 1/2" x 3/4"	25	25
C75274	K154600534	2 1/2" x 2 1/2" x 1"	25	25
C75275	K154600533	2 1/2" x 2 1/2" x 1 1/4"	20	20
C75276	K154600532	2 1/2" x 2 1/2" x 1 1/2"	20	20
C75277	K154600531	2 1/2" x 2 1/2" x 2"	15	15
C75154	K154600650	3"	10	10
C75575	K154600746	3" x 3/4" x 3"	10	10
C75281	K154600708	3" x 1 1/2" x 3"	10	10
C75282	K154600696	3" x 2" x 1 1/2"	10	10
C75283	K154600695	3" x 2" x 2"	15	15
C75285	K154600694	3" x 2" x 2 1/2"	10	10
C75286	K154600693	3" x 2" x 3"	10	10
C75287	K154600683	3" x 2 1/2" x 3/4"	15	15
C75576	K154600682	3" x 2 1/2" x 1"	15	15
C75288	K154600680	3" x 2 1/2" x 1 1/2"	15	15
C75289	K154600679	3" x 2 1/2" x 2"	15	15
C75290	K154600678	3" x 2 1/2" x 2 1/2"	10	10
C75291	K154600677	3" x 2 1/2" x 3"	10	10
C75292	K154600668	3" x 3" x 1/2"	10	10
C75293	K154600667	3" x 3" x 3/4"	20	20
C75294	K154600666	3" x 3" x 1"	20	20
C75295	K154600665	3" x 3" x 1 1/4"	15	15
C75296	K154600664	3" x 3" x 1 1/2"	15	15
C75297	K154600663	3" x 3" x 2"	13	13
C75298	K154600662	3" x 3" x 2 1/2"	10	10
C75155	K154600860	4"	5	5
C75299	K154600914	4" x 2" x 4"	4	4
C75300	K154600896	4" x 3" x 2 1/2"	4	4
C75301	K154600895	4" x 3" x 3"	5	5
C75302	K154600893	4" x 3" x 4"	5	5
C75303	K154600877	4" x 4" x 1/2"	5	5
C75304	K154600876	4" x 4" x 3/4"	8	8
C75305	K154600875	4" x 4" x 1"	8	8
C75306	K154600874	4" x 4" x 1 1/4"	8	8
C75307	K154600873	4" x 4" x 1 1/2"	8	8

JSC #	LTC #	SIZE	CTN QTY	MSTR QTY
C75308	K154600872	4" x 4" x 2"	6	6
C75309	K154600871	4" x 4" x 2 1/2"	5	5
C75310	K154600870	4" x 4" x 3"	5	5
C75156	K154600975	5"	2	2
C75157	K154601100	6"	1	1
C75577	K154601113	6" x 6" x 2"	2	2
C75578	K154601111	6" x 6" x 3"	1	1
C75579	K154601109	6" x 6" x 4"	2	2
C75158	K154601225	8"	1	1

Male Adapter

C x M

* Cast



LTC #	SIZE	CTN QTY	MSTR QTY
K101010050	1/2"	50	200
K101010057*	1/2" x 3/4"	25	250
K101010100	3/4"	25	150
K101010107*	3/4" x 1/2"	25	300
K101010105	3/4" x 1 1/4"	10	80
K101010150	1"	10	100
K101010215	1 1/4"	10	60
K101010295*	1 1/2"	10	50
K101010390*	2"	5	50
K101010520*	2 1/2"	-	20
K101010860*	4"	-	-

Hose Adapter

C x Hose Thd

* Cast



LTC #	SIZE	CTN QTY	MSTR QTY
K101020057*	1/2" x 3/4"	-	75

Female Adapter

C x F

* Cast



LTC #	SIZE	CTN QTY	MSTR QTY
K101050050	1/2"	50	400
K101050057*	1/2" x 3/4"	-	-
K101050100	3/4"	25	150
K101050105	3/4" x 1 1/4"	10	80
K101050106*	3/4" x 1"	-	150
K101050150	1"	10	100
K101050157*	1" x 1 1/2"	-	40
K101050215*	1 1/4"	10	100
K101050295	1 1/2"	10	100
K101050304*	1 1/2" x 1"	-	60
K101050390*	2"	-	24
K101050650*	3"	-	12

Fitting Female Adapter

Ftg x F

* Cast



LTC #	SIZE	CTN QTY	MSTR QTY
K101150059	1/2" x 1/4"	50	500
K101150107*	3/4" x 1/2"	-	-

Flush Bushing

Ftg x C

* Cast



LTC #	SIZE	CTN QTY	MSTR QTY
K101400663	3" x 2"	-	25

Drain Coupling w/Cap

* Cast



LTC #	SIZE	CTN QTY	MSTR QTY
K101750050*	1/2"	10	200
K101750100*	3/4"	25	200

Cross

C x C x C x C

* Cast



LTC #	SIZE	CTN QTY	MSTR QTY
K101950050	1/2"	45	180
K101950100	3/4"	10	100
K101950150*	1"	5	100
K101950215*	1 1/4"	5	50
K101950390*	2"	-	25

90° Ell

C x C

* Cast



LTC #	SIZE	CTN QTY	MSTR QTY
K102350223	1 1/4" x 3/4"	10	60

90° Ell w/Drain Cap

C x C

* Cast



LTC #	SIZE	CTN QTY	MSTR QTY
K102360050	1/2"	-	25

90° Drop Ell

C x C

* Cast



LTC #	SIZE	CTN QTY	MSTR QTY
K102400100	3/4"	10	80
K102400150*	1"	-	-

90° Hi-Ear Ell

C x C



LTC #	SIZE	CTN QTY	MSTR QTY
K142400050	1/2"	25	250
K142400100	3/4"	10	100

90° Ell

C x M



LTC #	SIZE	CTN QTY	MSTR QTY
K102550025	3/8"	50	400
K102550050	1/2"	50	200
K102550057	1/2" x 3/4"	25	200
K102550058	1/2" x 3/8"	50	250
K102550100	3/4"	25	150
K102550107	3/4" x 1/2"	10	100
K102550150	1"	10	80
K102550215	1 1/4"	10	50
K102550295	1 1/2"	5	40
K102550390	2"	-	20

90° Hi-Ear Ell

C x F



LTC #	SIZE	CTN QTY	MSTR QTY
K142590050	1/2"	25	150
K142590100	3/4"	25	100

90° Flanged Sink Ell

C x F



LTC #	SIZE	CTN QTY	MSTR QTY
K102600050	1/2"	25	100

90° Ell

C x F

* Cast



LTC #	SIZE	CTN QTY	MSTR QTY
K102570050	1/2"	50	250
K102570057	1/2" x 3/4"	25	150
K102570058	1/2" x 3/8"	25	250
K102570059*	1/2" x 1/4"	-	25
K102570100	3/4"	25	100
K102570107	3/4" x 1/2"	25	200
K102570150	1"	10	50
K102570160	1" x 1/2"	10	100
K102570215	1 1/4"	5	60
K102570295	1 1/2"	5	20
K102570390	2"	-	20

90° Drop Ell

C x F

* Cast



LTC #	SIZE	CTN QTY	MSTR QTY
K102590050	1/2"	25	200
K102590058	1/2" x 3/8"	25	200
K102590107	3/4" x 1/2"	25	100
K102590150*	1"	10	120

45° Ell

C x C

* Cast



LTC #	SIZE	CTN QTY	MSTR QTY
K102900860*	4"	-	5

Drop Tee

C x C x C



LTC #	SIZE	CTN QTY	MSTR QTY
K104670050	1/2"	25	250

Tee

C x C x F

* Cast



LTC #	SIZE	CTN QTY	MSTR QTY
K104800025	3/8"	50	500
K104800050	1/2"	25	200
K104800057	1/2" x 1/2" x 3/4"	25	200
K104800058	1/2" x 1/2" x 3/8"	25	200
K104800100	3/4"	10	100
K104800106	3/4" x 3/4" x 1"	25	50
K104800107	3/4" x 3/4" x 1/2"	25	100
K104800108	3/4" x 3/4" x 3/8"	-	-
K104800117	3/4" x 1/2" x 3/4"	25	100
K104800150	1"	5	60
K104800159	1" x 1" x 3/4"	10	80
K104800160	1" x 1" x 1/2"	10	100
K104800215*	1 1/4"	-	50
K104800222*	1 1/4" x 1 1/4" x 1"	-	25
K104800223	1 1/4" x 1 1/4" x 3/4"	10	50
K104800224	1 1/4" x 1 1/4" x 1/2"	10	50
K104800295	1 1/2"	-	25
K104800304	1 1/2" x 1 1/2" x 1"	5	40
K104800306	1 1/2" x 1 1/2" x 1/2"	5	40
K104800400	2" x 2" x 1"	-	25

Drop Tee

C x C x F



LTC #	SIZE	CTN QTY	MSTR QTY
K104820050	1/2"	25	150

Tee

C x F x C

* Cast



LTC #	SIZE	CTN QTY	MSTR QTY
K104920050	1/2"	25	300
K104920100	3/4"	10	100
K104920117	3/4" x 1/2" x 3/4"	25	100
K104920150*	1"	-	15
K104920169	1" x 3/4" x 1"	10	40
K104920180	1" x 1/2" x 1"	10	50

Baseboard Tee

C x F x C



LTC #	SIZE	CTN QTY	MSTR QTY
K104920081	1/2" x 1/8" x 1/2"	50	250
K104920143	3/4" x 1/8" x 3/4"	25	100
K104920206	1" x 1/8" x 1"	10	50
K104920283	1 1/4" x 1/8" x 1 1/4"	10	60

Tee

C x F x F

* Cast



LTC #	SIZE	CTN QTY	MSTR QTY
K104950050*	1/2"	-	30

Tee

F x F x C

* Cast



LTC #	SIZE	CTN QTY	MSTR QTY
K104980050	1/2"	25	100
K104980100*	3/4"	-	25
K104980118	3/4" x 1/2" x 1/2"	10	100
K104980107	3/4" x 3/4" x 1/2"	10	100

45° Wye

C x C x C

* Cast



LTC #	SIZE	CTN QTY	MSTR QTY
K108400100	3/4"	-	120
K108400295	1 1/2"	5	50
K108400390	2"	-	-

Union

C x M



LTC #	SIZE	CTN QTY	MSTR QTY
K126610025	3/8"	25	300
K126610050	1/2"	25	200
K126610100	3/4"	10	100
K126610150	1"	10	50
K126610215	1 1/4"	5	30
K126610295	1 1/2"	-	50
K126610390	2"	-	25

Union

C x F



LTC #	SIZE	CTN QTY	MSTR QTY
K126650050	1/2"	25	200
K126650100	3/4"	25	100
K126650150	1"	10	100
K126650215	1 1/4"	5	40
K126650295	1 1/2"	-	50
K126650390	2"	-	25

Male Adapter

C x M



LTC #	SIZE	CTN QTY	MSTR QTY
161010295	1 1/2"	10	100
161010390	2"	5	100

Female Adapter

C x F



LTC #	SIZE	CTN QTY	MSTR QTY
161050215	1 1/4"	-	150
161050295	1 1/2"	10	100
161050390	2"	10	100

Test Cap



LTC #	SIZE	CTN QTY	MSTR QTY
161570050	1/2"	-	-
161570100	3/4"	-	-
161570150	1"	-	400
161570215	1 1/4"	50	600
161570295	1 1/2"	50	600
161570390	2"	50	100
161570650	3"	25	200

Closet Flange Less Tube Stop



LTC #	SIZE	CTN QTY	MSTR QTY
163400860	4"	5	5

Tee

C x C x C



LTC #	SIZE	CTN QTY	MSTR QTY
164600390	2"	5	25
164600398	2" x 1 1/2"	5	50
164600665	3" x 1 1/4"	5	40

Coupling w/Stop

C x C



LTC #	SIZE	CTN QTY	MSTR QTY
161650215	1 1/4"	25	250
161650295	1 1/2"	25	250
161650303	1 1/2" x 1 1/4"	25	300
161650390	2"	-	250
161650398	2" x 1 1/2"	10	100
161650399	2" x 1 1/4"	10	100
161650650	3"	-	80
161650663	3" x 2"	5	100
161650664	3" x 1 1/2"	5	50
161650860	4"	-	36
161650872	4" x 2"	-	-

Coupling Less Stop

C x C



LTC #	SIZE	CTN QTY	MSTR QTY
161720215	1 1/4"	25	200
161720295	1 1/2"	25	200
161720390	2"	-	100
161720650	3"	-	-
161720860	4"	2	2

90° Ell

C x C



LTC #	SIZE	CTN QTY	MSTR QTY
162350215	1 1/4"	25	100
162350295	1 1/2"	10	100
162350390	2"	5	50

90° Long Turn Ell

C x C



LTC #	SIZE	CTN QTY	MSTR QTY
162420295	1 1/2"	-	-
162420390	2"	-	-

90° Street Ell

Ftg x C



LTC #	SIZE	CTN QTY	MSTR QTY
162540215	1 1/4"	-	200
162540295	1 1/2"	10	100
162540390	2"	50	50

45° Ell

C x C



LTC #	SIZE	CTN QTY	MSTR QTY
162900215	1 1/4"	25	200
162900295	1 1/2"	25	150
162900390	2"	5	5
162900650	3"	2	2

45° Street Ell

Ftg x C



LTC #	SIZE	CTN QTY	MSTR QTY
162950215	1 1/4"	10	10
162950295	1 1/2"	10	100
162950390	2"	5	50

Fitting Reducer

Ftg x C



LTC #	SIZE	CTN QTY	MSTR QTY
164100303	1 1/2" x 1 1/4"	25	250
164100398	2" x 1 1/2"	10	100
164100399	2" x 1 1/4"	-	-
164100663	3" x 2"	-	50
164100664	3" x 1 1/2"	5	50

Male Adapter

C x M



LTC #	SIZE	CTN QTY	MSTR QTY
K201010215	1 1/4"	10	300
K201010295	1 1/2"	10	100
K201010303	1 1/2" x 1 1/4"	75	75
K201010390	2"	60	60
K201010650	3"	-	20
K201010860	4"	-	20

Female Adapter

C x F



LTC #	SIZE	CTN QTY	MSTR QTY
K201050221	1 1/4" x 1 1/2"	-	5
K201050295	1 1/2"	10	150
K201050302	1 1/2" x 2"	-	5
K201050650	3"	-	25
K201050860	4"	-	20

Soil Pipe Adapter

C x Spigot



LTC #	SIZE	CTN QTY	MSTR QTY
K201100390	2"	50	50
K201100394	2" x 4"	-	25
K201100650	3"	-	5
K201100660	3" x 4"	-	20

Soil Pipe Adapter

C x No Hub



LTC #	SIZE	CTN QTY	MSTR QTY
K201120302	1 1/2" x 2"	-	50
K201120390	2"	50	50

Female Adapter

Ftg x F



LTC #	SIZE	CTN QTY	MSTR QTY
K201150295	1 1/2"	100	100
K201150390	2"	50	50

Trap Adapter

F x SJ



LTC #	SIZE	CTN QTY	MSTR QTY
K201200295	1 1/2"	-	10

Cap



LTC #	SIZE	CTN QTY	MSTR QTY
K201540295	1 1/2"	-	-

Fitting Cleanout

Ftg x Cleanout w/Plug



LTC #	SIZE	CTN QTY	MSTR QTY
K201610215	1 1/4"	120	120
K201610295	1 1/2"	-	100
K201610390	2"	60	60

Flush Fitting Cleanout

Ftg x Cleanout w/Plug



LTC #	SIZE	CTN QTY	MSTR QTY
K201620215	1 1/4"	-	25
K201620650	3"	25	25

Coupling

C x C



LTC #	SIZE	CTN QTY	MSTR QTY
K201650663	3" x 2"	-	-
K201650664	3" x 1 1/2"	-	-
K201650872	4" x 2"	-	25

90° Ell

C x C



LTC #	SIZE	CTN QTY	MSTR QTY
K202350303	1 1/2" x 1 1/4"	75	75
K202350398	2" x 1 1/2"	25	25
K202350650	3"	10	10
K202350663	3" x 2"	25	25
K202350860	4"	-	-

90° Street Ell

Ftg x C



LTC #	SIZE	CTN QTY	MSTR QTY
K202540215	1 1/4"	-	25
K202540390	2"	20	20
K202540650	3"	-	-
K202540860	4"	-	10

90° Ell

C x M



LTC #	SIZE	CTN QTY	MSTR QTY
K202550295	1 1/2"	50	50

90° Ell

C x F



LTC #	SIZE	CTN QTY	MSTR QTY
K202570295	1 1/2"	75	75
K202570390	2"	-	25

60° Ell

C x C



LTC #	SIZE	CTN QTY	MSTR QTY
K202850390	2"	80	80
K202850650	3"	20	20

45° Ell

C x C



LTC #	SIZE	CTN QTY	MSTR QTY
K202900860	4"	-	-

45° Ell

Ftg x C



LTC #	SIZE	CTN QTY	MSTR QTY
K202950650	3"	-	25

45° Ell

C x M



LTC #	SIZE	CTN QTY	MSTR QTY
K202960295	1 1/2"	-	-

22 1/2° Ell

C x C



LTC #	SIZE	CTN QTY	MSTR QTY
K203100215	1 1/4"	-	25
K203100295	1 1/2"	-	-
K203100390	2"	-	50
K203100860	4"	15	15

1 1/4° Ell

C x C



LTC #	SIZE	CTN QTY	MSTR QTY
K203150295	1 1/2"	-	10
K203150650	3"	20	20

Closet Flange Less Tube Stop



LTC #	SIZE	CTN QTY	MSTR QTY
K203400860	4"	-	5

Extended Bushing

Ftg x C



LTC #	SIZE	CTN QTY	MSTR QTY
K204100663	3" x 2"	-	-
K204100870	4" x 3"	40	40

Return Bend

C x C

LTC #	SIZE	CTN QTY	MSTR QTY
K204180295	1 1/2"	-	-

Tee

C x C x C



LTC #	SIZE	CTN QTY	MSTR QTY
K204600215	1 1/4"	50	50
K204600295	1 1/2"	60	60
K204600390	2"	25	25
K204600398	2" x 1 1/2"	40	40
K204600413	2" x 1 1/2" x 2"	-	-
K204600414	2" x 1 1/2" x 1 1/2"	50	50
K204600650	3"	15	15
K204600663	3" x 3" x 2"	10	10
K204600860	4"	-	5
K204600873	4" x 1 1/2"	-	10

Double Tee

C x C x C x C



LTC #	SIZE	CTN QTY	MSTR QTY
K204650295	1 1/2"	25	25
K204650390	2"	-	25
K204650398	2" x 1 1/2"	-	-
K204650695	3" x 2"	-	15

Tee

C x C x F



LTC #	SIZE	CTN QTY	MSTR QTY
K204800215	1 1/4"	50	50
K204800295	1 1/2"	60	60
K204800390	2"	-	25
K204800414	2" x 1 1/2" x 1 1/2"	20	20

Test Tee

C x C x Cleanout w/Plug



LTC #	SIZE	CTN QTY	MSTR QTY
K204850295	1 1/2"	-	50
K204850390	2"	-	25

Tee

C x F x C



LTC #	SIZE	CTN QTY	MSTR QTY
K204920295	1 1/2"	-	-

Utility Tee

C x C x C x C



LTC #	SIZE	CTN QTY	MSTR QTY
K204990390	2"	-	-

Double Long Turn T-Y

C x C x C x C



LTC #	SIZE	CTN QTY	MSTR QTY
K205220390	2"	-	25

Wye

C x C x C



LTC #	SIZE	CTN QTY	MSTR QTY
K208400215	1 1/4"	-	-
K208400295	1 1/2"	-	50
K208400303	1 1/2" x 1 1/4"	-	-
K208400390	2"	-	25
K208400398	2" x 1 1/2"	-	50
K208400399	2" x 1 1/4"	-	50
K208400413	2" x 1 1/2" x 2"	-	50
K208400650	3"	-	-
K208400664	3" x 3" x 1 1/2"	-	-
K208400665	3" x 3" x 1 1/4"	-	25

Double Wye

C x C x C x C



LTC #	SIZE	CTN QTY	MSTR QTY
K208450295	1 1/2"	-	50
K208450650	3"	-	10
K208450695	3" x 2"	-	-

Swivel Drum Trap

C x C x Cleanout w/Plug



LTC #	SIZE	CTN QTY	MSTR QTY
K245411541	1 1/2" x 3" x 6"	20	20

P-Traps

C x C



LTC #	SIZE	CTN QTY	MSTR QTY
K245500215	1 1/4"	-	-
K245500295	1 1/2"	-	-
K245500390	2"	20	20

P-Traps w/Cleanout

C x C x Cleanout w/Plug



LTC #	SIZE	CTN QTY	MSTR QTY
K245510215	1 1/4"	-	50
K245510295	1 1/2"	20	20
K245510390	2"	-	25

P-Trap

C x SJ



LTC #	SIZE	CTN QTY	MSTR QTY
K245540295	1 1/2"	-	25

P-Trap w/Union Joint LA Pattern

F x SJ



LTC #	SIZE	CTN QTY	MSTR QTY
K245560295	1 1/2"	-	-

P-Trap w/Union Joint & Cleanout

C x SJ x Cleanout w/Plug



LTC #	SIZE	CTN QTY	MSTR QTY
K245610295	1 1/2"	-	50

125# Companion Flange w/A.S.M.E. Drilling

Copper Sweat



LTC #	SIZE	CTN QTY	MSTR QTY
K113420100	3/4"	30	30
K113420150	1"	50	50
K113420215	1 1/4"	45	45
K113420295	1 1/2"	24	24
K113420390	2"	15	15
K113420520	2 1/2"	12	12
K113420650	3"	6	6
K113420860	4"	6	6
K113421100	6"	2	2

150# Companion Flange w/A.S.M.E. Drilling

Copper Sweat



LTC #	SIZE	CTN QTY	MSTR QTY
K113450150	1"	20	20
K113450215	1 1/4"	30	30
K113450295	1 1/2"	20	20
K113450390	2"	15	15
K113450520	2 1/2"	5	5
K113450650	3"	6	6
K113450860	4"	3	3
K113451100	6"	2	2
K113451225	8"	1	1

- IAPMO & NSF-61 CERTIFICATIONS
- MEETS STRICT ANSI SPECS
- MATERIAL SPECIFICATIONS TO ASTM B88
- CARTON QUANTITIES ONLY

NOMINAL (I.D.) PLUMBING SIZE	REFRIGERATION (O.D.) HVAC SIZE
1/8"	1/4"
1/4"	3/8"
3/8"	1/2"
5/8"	3/4"
3/4"	7/8"
1"	1 1/8"
1 1/4"	1 3/8"
1 1/2"	1 5/8"
2"	2 1/8"
2 1/2"	2 5/8"
3"	3 1/8"
4"	4 1/8"

A
Adapters
 Female 1, 9, 13, 15
 Fitting Female 2, 9
 Fitting Male 1
 Hose 9
 Male 1, 9, 13, 15
 Soil Pipe 15

C
Cap 3, 15
 Test 13
Closet Flange Less Tube Stop 13, 17
Companion Flanges, Cast Brass
 125# w/A.S.M.E. Drilling 19
 150# w/A.S.M.E. Drilling 19
Couplings 16
 Crossover 3
 Drain, with Cap 9
 Less Stop 13
 Reducing 2
 (Socket) Less Tube Stop 3
 (Socket) w/Dimple Tube Stop 3
 (Socket) w/Rolled Tube Stop 2
 With Stop 13
Cross 9

E
Ells
 11 1/4° 16
 22 1/2° 16
 45° 4, 11, 14, 16
 Street 5, 14
 60° 16
 90° 9, 10, 13, 16
 Drop 10
 Flanged Sink 10
 Hi-Ear 10
 Intermediate Turn 4
 Long Turn 4, 13
 Long Turn Street 4
 Short Turn 3
 Short Turn Street 4
 Street 14, 16
 with Drain Cap 10
Extended Bushing 17

F
Fitting Cleanout 15
Fitting Cleanout, Flush 15
Fitting Plug 5
Fitting Reducer 14
Flush Bushing 2, 9
Flush Fitting Cleanout 15

P
Plug, Fitting 5
P-Traps 18
 Suction Line 5
 With Cleanout 18
 With Union Joint & Cleanout 18
 With Union Joint LA Pattern 18

R
Return Bend 17

S
Swivel Drum Trap 18

T
Tees 7, 11, 13, 17
 Baseboard 11
 Double 17
 Double Long Turn T-Y 17
 Drop 11
 Test 17
 Utility 17

U
Union 6, 12
U-Type Strap 6

W
Wye 18
 45° 11
 Double 18

PART NO.	PG #
161010295	13
161010390	13
161050215	13
161050295	13
161050390	13
161570050	13
161570100	13
161570150	13
161570215	13
161570295	13
161570390	13
161570650	13
161650215	13
161650295	13
161650303	13
161650390	13
161650398	13
161650399	13
161650650	13
161650663	13
161650664	13
161650860	13
161650872	13
161720215	13
161720295	13
161720390	13
161720650	13
161720860	13
162350215	13
162350295	13
162350390	13
162420295	13
162420390	13
162540215	14
162540295	14
162540390	14
162900215	14
162900295	14
162900390	14
162900650	14
162950215	14
162950295	14
162950390	14
163400860	13
164100303	14
164100398	14
164100399	14
164100663	14
164100664	14
164600390	13
164600398	13
164600665	13
C75000	2
C75001	2
C75002	2
C75003	2
C75004	2
C75005	2
C75006	2
C75007	2

PART NO.	PG #
C75008	2
C75009	2
C75010	2
C75011	2
C75012	2
C75013	2
C75014	3
C75015	3
C75016	3
C75017	3
C75018	3
C75019	3
C75020	3
C75021	3
C75022	3
C75023	3
C75024	3
C75025	3
C75026	3
C75027	3
C75028	3
C75029	3
C75030	3
C75031	3
C75032	3
C75033	3
C75034	3
C75035	3
C75036	3
C75037	3
C75038	3
C75039	4
C75040	4
C75041	4
C75042	4
C75043	4
C75044	4
C75045	4
C75046	4
C75047	4
C75048	4
C75049	4
C75050	4
C75051	4
C75052	4
C75053	4
C75054	4
C75055	3
C75056	3
C75057	3
C75058	3
C75059	3
C75060	3
C75061	3
C75062	3
C75063	3
C75064	3
C75065	3
C75066	3
C75067	3

PART NO.	PG #
C75068	3
C75069	2
C75070	2
C75071	2
C75072	2
C75073	2
C75074	2
C75075	2
C75076	2
C75077	2
C75078	2
C75079	2
C75080	2
C75081	2
C75082	2
C75083	2
C75084	2
C75085	2
C75086	2
C75087	2
C75088	2
C75089	2
C75090	2
C75091	2
C75092	2
C75093	2
C75094	2
C75095	2
C75096	2
C75097	2
C75098	2
C75099	2
C75100	2
C75101	2
C75102	2
C75103	2
C75104	2
C75105	2
C75106	2
C75107	2
C75108	2
C75109	2
C75110	2
C75111	1
C75112	1
C75113	1
C75114	1
C75115	1
C75116	1
C75117	1
C75118	1
C75119	1
C75120	1
C75121	1
C75122	1
C75123	1
C75124	1
C75125	1
C75126	1
C75127	1

PART NO.	PG #
C75128	1
C75129	1
C75130	1
C75131	1
C75132	1
C75133	1
C75134	1
C75135	1
C75136	1
C75137	1
C75138	1
C75139	1
C75140	1
C75141	1
C75142	1
C75143	7
C75144	7
C75145	7
C75146	7
C75147	7
C75148	7
C75149	7
C75150	7
C75151	7
C75152	7
C75153	8
C75154	8
C75155	8
C75156	8
C75157	8
C75158	8
C75159	7
C75160	7
C75161	7
C75162	7
C75163	7
C75164	7
C75165	7
C75166	7
C75167	7
C75168	7
C75169	7
C75170	7
C75171	7
C75172	7
C75173	7
C75174	7
C75175	7
C75176	7
C75177	7
C75178	7
C75179	7
C75181	7
C75182	7
C75183	7
C75184	7
C75185	7
C75186	7
C75187	7
C75188	7

PART NO.	PG #
C75189	7
C75190	7
C75191	7
C75192	7
C75193	7
C75194	7
C75195	7
C75196	7
C75197	7
C75198	7
C75199	7
C75200	7
C75201	7
C75202	7
C75203	7
C75204	7
C75205	7
C75206	7
C75207	7
C75208	7
C75209	7
C75210	7
C75211	7
C75212	7
C75213	7
C75214	7
C75215	7
C75216	7
C75217	7
C75218	7
C75219	7
C75220	7
C75221	7
C75222	7
C75223	7
C75224	7
C75225	7
C75226	7
C75227	7
C75228	7
C75229	7
C75230	7
C75231	7
C75232	7
C75233	7
C75234	7
C75235	7
C75236	7
C75237	7
C75238	8
C75239	8
C75240	8
C75241	8
C75242	8
C75243	7
C75244	7
C75245	7
C75246	7
C75247	8
C75248	7

PART NO.	PG #
C75249	7
C75250	7
C75251	7
C75252	7
C75253	7
C75254	7
C75255	7
C75256	7
C75257	7
C75258	7
C75259	7
C75260	8
C75261	8
C75262	8
C75263	8
C75264	8
C75265	8
C75266	8
C75267	8
C75268	8
C75269	8
C75270	8
C75271	8
C75272	8
C75273	8
C75274	8
C75275	8
C75276	8
C75277	8
C75281	8
C75282	8
C75283	8
C75285	8
C75286	8
C75287	8
C75288	8
C75289	8
C75290	8
C75291	8
C75292	8
C75293	8
C75294	8
C75295	8
C75296	8
C75297	8
C75298	8
C75299	8
C75300	8
C75301	8
C75302	8
C75303	8
C75304	8
C75305	8
C75306	8
C75307	8
C75308	8
C75309	8
C75310	8
C75311	1
C75312	1

PART NO.	PG #
C75313	1
C75314	1
C75315	1
C75316	1
C75317	1
C75318	1
C75319	1
C75320	1
C75321	1
C75322	1
C75323	1
C75324	1
C75325	1
C75326	1
C75327	1
C75328	1
C75329	1
C75330	1
C75331	1
C75332	1
C75333	1
C75334	1
C75335	1
C75336	1
C75337	1
C75338	1
C75339	1
C75340	1
C75341	1
C75342	1
C75343	1
C75345	1
C75346	1
C75347	1
C75348	1
C75349	1
C75350	1
C75351	1
C75352	1
C75353	1
C75354	1
C75355	1
C75356	1
C75357	1
C75358	1
C75359	1
C75360	5
C75361	5
C75362	5
C75363	5
C75365	5
C75366	5
C75367	5
C75368	5
C75369	5
C75370	5
C75371	5
C75372	5
C75373	5
C75374	5

PART NO.	PG #
C75375	2
C75377	4
C75378	4
C75379	4
C75380	4
C75381	4
C75382	4
C75383	4
C75384	4
C75385	4
C75386	4
C75387	4
C75388	4
C75392	2
C75393	2
C75394	2
C75395	2
C75396	2
C75397	2
C75398	2
C75399	2
C75400	2
C75401	2
C75402	4
C75403	4
C75404	4
C75405	4
C75406	4
C75407	4
C75408	4
C75409	4
C75410	4
C75411	4
C75412	3
C75413	3
C75414	3
C75415	3
C75416	3
C75417	3
C75418	3
C75419	3
C75420	3
C75421	3
C75422	3
C75423	3
C75424	3
C75425	6
C75426	6
C75427	6
C75428	6
C75429	6
C75430	6
C75431	6
C75432	6
C75433	6
C75434	6
C75435	6
C75436	6
C75437	6
C75438	6

PART NO.	PG #
C75439	6
C75440	6
C75441	6
C75442	6
C75443	6
C75444	6
C75445	6
C75446	6
C75447	6
C75448	6
C75449	6
C75450	6
C75451	6
C75452	6
C75453	6
C75454	6
C75455	6
C75456	6
C75457	6
C75458	6
C75459	6
C75460	6
C75461	6
C75462	6
C75463	5
C75464	5
C75465	5
C75466	5
C75467	5
C75468	5
C75469	5
C75470	5
C75471	5
C75472	5
C75473	5
C75474	5
C75475	5
C75476	2
C75477	2
C75478	2
C75479	4
C75480	4
C75481	4
C75482	4
C75483	4
C75484	4
C75485	4
C75486	4
C75487	4
C75488	4
C75489	4
C75490	4
C75491	4
C75492	4
C75493	4
C75494	1
C75500	6
C75501	6
C75502	6
C75503	6

PART NO.	PG #
C75504	6
C75505	6
C75506	6
C75507	6
C75508	6
C75509	6
C75510	6
C75516	2
C75517	2
C75518	2
C75519	3
C75520	3
C75521	3
C75522	3
C75523	3
C75525	5
C75527	5
C75530	4
C75531	4
C75532	4
C75533	4
C75534	4
C75535	4
C75536	4
C75537	4
C75540	4
C75541	4
C75542	4
C75543	4
C75544	4
C75546	4
C75548	3
C75550	3
C75551	3
C75552	3
C75553	3
C75554	3
C75555	3
C75556	3
C75557	3
C75558	3
C75559	3
C75560	6
C75561	6
C75562	6
C75563	6
C75564	3
C75565	3
C75566	2
C75567	2
C75568	5
C75570	7
C75571	7
C75572	7
C75573	8
C75574	8
C75575	8
C75576	8
C75577	8
C75578	8

PART NO.	PG #
C75579	8
C75580	3
C75581	3
C75582	3
C75583	3
C75586	3
C75587	3
K101010050	9
K101010057	9
K101010100	9
K101010105	9
K101010107	9
K101010150	9
K101010215	9
K101010295	9
K101010390	9
K101010520	9
K101010860	9
K101020057	9
K101050050	9
K101050057	9
K101050100	9
K101050105	9
K101050106	9
K101050150	9
K101050157	9
K101050215	9
K101050295	9
K101050304	9
K101050390	9
K101050650	9
K101150059	9
K101150107	9
K101400663	9
K101750050	9
K101750100	9
K101950050	9
K101950100	9
K101950150	9
K101950215	9
K101950390	9
K102350223	9
K102360050	10
K102400100	10
K102400150	10
K102550025	10
K102550050	10
K102550057	10
K102550058	10
K102550100	10
K102550107	10
K102550150	10
K102550215	10
K102550295	10
K102550390	10
K102570050	10
K102570057	10
K102570058	10
K102570059	10
K102570100	10

PART NO.	PG #
K102570107	10
K102570150	10
K102570160	10
K102570215	10
K102570295	10
K102570390	10
K102590050	10
K102590058	10
K102590107	10
K102590150	10
K102600050	10
K102900860	11
K104670050	11
K104800025	11
K104800050	11
K104800057	11
K104800058	11
K104800100	11
K104800106	11
K104800107	11
K104800108	11
K104800117	11
K104800150	11
K104800159	11
K104800160	11
K104800215	11
K104800222	11
K104800223	11
K104800224	11
K104800295	11
K104800304	11
K104800306	11
K104800400	11
K104820050	11
K104920050	11
K104920081	11
K104920100	11
K104920117	11
K104920143	11
K104920150	11
K104920169	11
K104920180	11
K104920206	11
K104920283	11
K104950050	11
K104980050	11
K104980100	11
K104980107	11
K104980118	11
K108400100	11
K108400295	11
K108400390	11
K113420100	19
K113420150	19
K113420215	19
K113420295	19
K113420390	19
K113420520	19
K113420650	19
K113420860	19

PART NO.	PG #
K113421100	19
K113450150	19
K113450215	19
K113450295	19
K113450390	19
K113450520	19
K113450650	19
K113450860	19
K113451100	19
K113451225	19
K126570090	6
K126570215	6
K126570295	6
K126570390	6
K126570520	6
K126570650	6
K126610025	12
K126610050	12
K126610100	12
K126610150	12
K126610215	12
K126610295	12
K126610390	12
K126650050	12
K126650100	12
K126650150	12
K126650215	12
K126650295	12
K126650390	12
K142400050	10
K142400100	10
K142590050	10
K142590100	10
K151010001	1
K151010002	1
K151010005	1
K151010006	1
K151010007	1
K151010024	1
K151010025	1
K151010031	1
K151010032	1
K151010050	1
K151010056	1
K151010057	1
K151010058	1
K151010059	1
K151010092	1
K151010093	1
K151010100	1
K151010106	1
K151010107	1
K151010150	1
K151010157	1
K151010158	1
K151010159	1
K151010160	1
K151010215	1
K151010221	1
K151010222	1

PART NO.	PG #
K151010223	1
K151010295	1
K151010302	1
K151010303	1
K151010304	1
K151010390	1
K151010398	1
K151010399	1
K151010520	1
K151010531	1
K151010650	1
K151010860	1
K151050001	1
K151050002	1
K151050006	1
K151050024	1
K151050025	1
K151050031	1
K151050032	1
K151050050	1
K151050056	1
K151050057	1
K151050058	1
K151050059	1
K151050060	1
K151050092	1
K151050093	1
K151050100	1
K151050106	1
K151050107	1
K151050150	1
K151050158	1
K151050159	1
K151050160	1
K151050215	1
K151050221	1
K151050222	1
K151050223	1
K151050295	1
K151050302	1
K151050303	1
K151050390	1
K151050398	1
K151050520	1
K151050650	1
K151140002	1
K151140025	1
K151140050	1
K151140057	1
K151140100	1
K151140150	1
K151140215	1
K151140295	1
K151140390	1
K151150002	2
K151150025	2
K151150050	2
K151150057	2
K151150058	2
K151150100	2

PART NO.	PG #
K151150150	2
K151150215	2
K151150295	2
K151150390	2
K151400007	5
K151400032	5
K151400058	5
K151400059	5
K151400107	5
K151400108	5
K151400109	5
K151400149	5
K151400159	5
K151400160	5
K151400222	5
K151400223	5
K151400303	5
K151400398	5
K151401498	5
K151420060	2
K151540001	3
K151540002	3
K151540025	3
K151540050	3
K151540090	3
K151540100	3
K151540150	3
K151540215	3
K151540295	3
K151540390	3
K151540520	3
K151540650	3
K151540860	3
K151541100	3
K151650001	2
K151650002	2
K151650007	2
K151650008	2
K151650015	2
K151650025	2
K151650032	2
K151650033	2
K151650050	2
K151650058	2
K151650059	2
K151650060	2
K151650090	2
K151650093	2
K151650094	2
K151650095	2
K151650100	2
K151650107	2
K151650108	2
K151650109	2
K151650149	2
K151650150	2
K151650159	2
K151650160	2
K151650161	2
K151650215	2

PART NO.	PG #
K151650222	2
K151650223	2
K151650224	2
K151650295	2
K151650303	2
K151650304	2
K151650305	2
K151650306	2
K151650390	2
K151650398	2
K151650399	2
K151650400	2
K151650401	2
K151650402	2
K151650520	2
K151650531	2
K151650532	2
K151650533	2
K151650534	2
K151650650	2
K151650662	2
K151650663	2
K151650664	2
K151650780	2
K151650790	2
K151650860	2
K151650870	2
K151650871	2
K151650872	2
K151650873	2
K151650874	2
K151650975	2
K151651100	2
K151651109	2
K151651111	2
K151651225	2
K151651498	2
K151651520	2
K151670050	3
K151700001	3
K151700002	3
K151700015	3
K151700025	3
K151700050	3
K151700090	3
K151700100	3
K151700150	3
K151700215	3
K151700295	3
K151700390	3
K151700520	3
K151700650	3
K151700780	3
K151700860	3
K151700975	3
K151701100	3
K151701225	3
K151720001	3
K151720002	3
K151720025	3

PART NO.	PG #	PART NO.	PG #	PART NO.	PG #	PART NO.	PG #
K151720050	3	K152420650	4	K153960050	5	K154600057	7
K151720090	3	K152420860	4	K153960150	5	K154600058	7
K151720100	3	K152540002	4	K154100007	6	K154600059	7
K151720150	3	K152540025	4	K154100032	6	K154600060	7
K151720215	3	K152540050	4	K154100033	6	K154600066	7
K151720295	3	K152540090	4	K154100058	6	K154600067	7
K151720390	3	K152540100	4	K154100059	6	K154600068	7
K151720520	3	K152540150	4	K154100093	6	K154600075	7
K151720650	3	K152540215	4	K154100094	6	K154600087	7
K151720860	3	K152540295	4	K154100095	6	K154600090	7
K151720975	3	K152540390	4	K154100107	6	K154600092	7
K152350001	3	K152540520	4	K154100108	6	K154600095	7
K152350002	3	K152540650	4	K154100109	6	K154600098	7
K152350025	3	K152540860	4	K154100149	6	K154600100	7
K152350032	3	K152670025	4	K154100159	6	K154600106	7
K152350050	3	K152670050	4	K154100160	6	K154600107	7
K152350058	3	K152670100	4	K154100161	6	K154600108	7
K152350059	3	K152670215	4	K154100222	6	K154600109	7
K152350090	3	K152720001	4	K154100223	6	K154600117	7
K152350093	3	K152720002	4	K154100224	6	K154600118	7
K152350100	3	K152720025	4	K154100303	6	K154600127	7
K152350107	3	K152720050	4	K154100304	6	K154600149	7
K152350150	3	K152720090	4	K154100305	6	K154600150	7
K152350159	3	K152720100	4	K154100306	6	K154600157	7
K152350160	3	K152720150	4	K154100398	6	K154600158	7
K152350215	3	K152720215	4	K154100399	6	K154600159	7
K152350222	3	K152720295	4	K154100400	6	K154600160	7
K152350223	3	K152720390	4	K154100401	6	K154600161	7
K152350295	3	K152720520	4	K154100402	6	K154600169	7
K152350303	3	K152720650	4	K154100531	6	K154600170	7
K152350390	3	K152720860	4	K154100532	6	K154600171	7
K152350398	3	K152900001	4	K154100533	6	K154600180	7
K152350520	3	K152900002	4	K154100534	6	K154600181	7
K152350650	3	K152900025	4	K154100662	6	K154600182	7
K152350780	3	K152900050	4	K154100663	6	K154600215	7
K152350860	3	K152900090	4	K154100664	6	K154600220	7
K152350975	3	K152900100	4	K154100665	6	K154600221	7
K152351100	3	K152900150	4	K154100869	6	K154600222	7
K152351225	3	K152900215	4	K154100870	6	K154600223	7
K152351520	3	K152900295	4	K154100871	6	K154600224	7
K152380025	4	K152900390	4	K154100872	6	K154600234	7
K152380090	4	K152900520	4	K154100874	6	K154600235	7
K152380100	4	K152900650	4	K154100983	6	K154600236	7
K152380150	4	K152900860	4	K154101498	6	K154600237	7
K152420001	4	K152900975	4	K154600001	7	K154600245	7
K152420002	4	K152901100	4	K154600002	7	K154600246	7
K152420015	4	K152901225	4	K154600005	7	K154600247	7
K152420025	4	K152950002	5	K154600006	7	K154600248	7
K152420050	4	K152950025	5	K154600007	7	K154600256	7
K152420090	4	K152950050	5	K154600012	7	K154600257	7
K152420093	4	K152950090	5	K154600013	7	K154600295	7
K152420100	4	K152950100	5	K154600024	7	K154600302	7
K152420149	4	K152950150	5	K154600025	7	K154600303	7
K152420150	4	K152950215	5	K154600031	7	K154600304	7
K152420159	4	K152950295	5	K154600032	7	K154600305	7
K152420215	4	K152950390	5	K154600033	7	K154600306	7
K152420295	4	K152950520	5	K154600041	7	K154600315	7
K152420304	4	K152950650	5	K154600046	7	K154600316	7
K152420390	4	K152950860	5	K154600050	7	K154600317	7
K152420520	4	K152951100	5	K154600056	7	K154600318	7

PART NO.	PG #
K154600319	7
K154600328	7
K154600329	7
K154600330	7
K154600331	7
K154600332	7
K154600339	7
K154600340	7
K154600341	7
K154600342	7
K154600343	7
K154600350	7
K154600352	7
K154600390	7
K154600397	7
K154600398	7
K154600399	7
K154600400	7
K154600401	7
K154600402	7
K154600413	7
K154600414	7
K154600415	7
K154600416	7
K154600417	7
K154600418	7
K154600429	8
K154600430	7
K154600431	7
K154600432	7
K154600433	7
K154600444	8
K154600445	8
K154600447	8
K154600457	8
K154600470	8
K154600520	8
K154600531	8
K154600532	8
K154600533	8
K154600534	8
K154600535	8
K154600536	8
K154600548	8
K154600549	8
K154600550	8
K154600551	8
K154600552	8
K154600553	8
K154600554	8
K154600564	8
K154600565	8
K154600566	8
K154600580	8
K154600583	8
K154600595	8
K154600608	8
K154600650	8
K154600662	8
K154600663	8

PART NO.	PG #
K154600664	8
K154600665	8
K154600666	8
K154600667	8
K154600668	8
K154600677	8
K154600678	8
K154600679	8
K154600680	8
K154600682	8
K154600683	8
K154600693	8
K154600694	8
K154600695	8
K154600696	8
K154600708	8
K154600746	8
K154600860	8
K154600870	8
K154600871	8
K154600872	8
K154600873	8
K154600874	8
K154600875	8
K154600876	8
K154600877	8
K154600893	8
K154600895	8
K154600896	8
K154600914	8
K154600975	8
K154601100	8
K154601109	8
K154601111	8
K154601113	8
K154601225	8
K154601498	7
K155330050	5
K155330090	5
K155330100	5
K155330150	5
K155330215	5
K155330295	5
K155330390	5
K156570002	6
K156570025	6
K156570050	6
K156570100	6
K156570150	6
K159470001	6
K159470002	6
K159470025	6
K159470050	6
K159470090	6
K159470100	6
K159470150	6
K159470215	6
K159470295	6
K159470390	6
K201010215	15

PART NO.	PG #
K201010295	15
K201010303	15
K201010390	15
K201010650	15
K201010860	15
K201050221	15
K201050295	15
K201050302	15
K201050650	15
K201050860	15
K201100390	15
K201100394	15
K201100650	15
K201100660	15
K201120302	15
K201120390	15
K201150295	15
K201150390	15
K201200295	15
K201540295	15
K201610215	15
K201610295	15
K201610390	15
K201620215	15
K201620650	15
K201650663	16
K201650664	16
K201650872	16
K202350303	16
K202350398	16
K202350650	16
K202350663	16
K202350860	16
K202540215	16
K202540390	16
K202540650	16
K202540860	16
K202550295	16
K202570295	16
K202570390	16
K202850390	16
K202850650	16
K202900860	16
K202950650	16
K202960295	16
K203100215	16
K203100295	16
K203100390	16
K203100860	16
K203150295	17
K203150650	17
K203400860	17
K204100663	17
K204100870	17
K204180295	17
K204600215	17
K204600295	17
K204600390	17
K204600398	17
K204600413	17

PART NO.	PG #
K204600414	17
K204600650	17
K204600663	17
K204600860	17
K204600873	17
K204650295	17
K204650390	17
K204650398	17
K204650695	17
K204800215	17
K204800295	17
K204800390	17
K204800414	17
K204850295	17
K204850390	17
K204920295	17
K204990390	17
K205220390	18
K208400215	18
K208400295	18
K208400303	18
K208400390	18
K208400398	18
K208400399	18
K208400413	18
K208400650	18
K208400664	18
K208400665	18
K208450295	18
K208450650	18
K208450695	18
K245411541	18
K245500215	18
K245500295	18
K245500390	18
K245510215	18
K245510295	18
K245510390	18
K245540295	18
K245560295	18
K245610295	18