

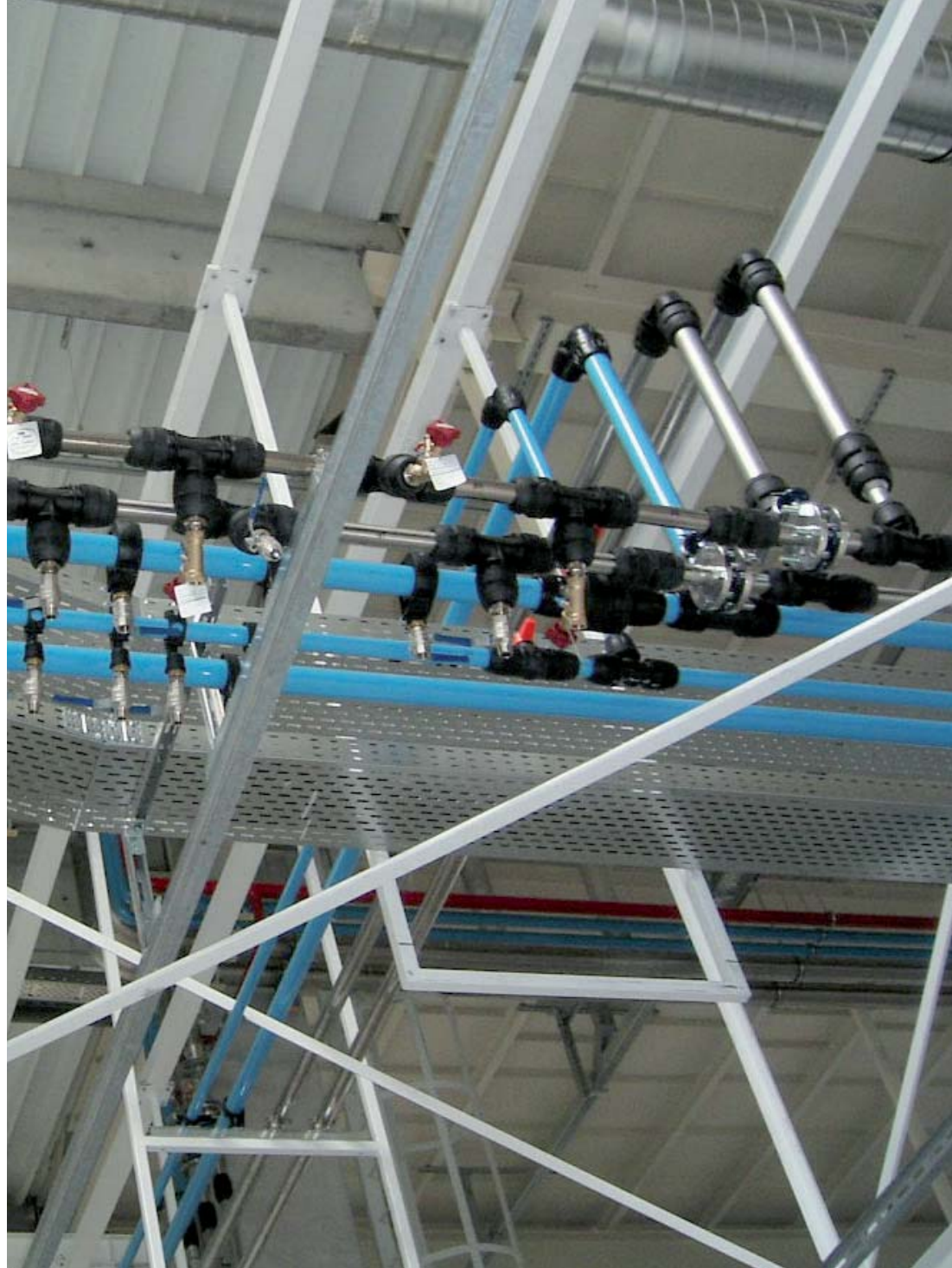

aerospace
climate control
electromechanical
filtration
fluid & gas handling
hydraulics
pneumatics
process control
sealing & shielding



Transair: Advanced Air Pipe Systems

Compressed Air, Vacuum, Inert Gas

1/2" - 6"



An Energy Efficient
Solution



ENGINEERING YOUR SUCCESS.

Parker Hannifin – the global leader and your partner



With annual sales exceeding \$12 billion, Parker Hannifin is the world's leading diversified manufacturer of motion and control technologies and systems, providing precision-engineered solutions for a wide variety of mobile, industrial and aerospace markets. Our products are vital to virtually everything that moves or requires control, including the manufacture and processing of raw materials, durable goods, infrastructure development and all forms of transport.

Within Parker's eight operating groups, the company's engineering expertise spans the core motion technologies – electromechanical, hydraulic and pneumatic – with a full complement of fluid handling, filtration, sealing and shielding, climate control, process control and aerospace technologies.

The leader in “dry technology” for the fluid power industry, Parker's Fluid Connectors Group is your single source for high-quality tube fittings, hose and hose fittings, thermoplastic tubing, brass fittings and valves, quick-disconnect couplings and assembly tools. The Fluid Connectors Group serves customers in a broad range of markets, including Aerial Lift, Agriculture, Bulk Chemical Handling, Construction Machinery,

Food & Beverage, Fuel & Gas Delivery, Industrial Machinery, Medical, Mining, Mobile, Oil & Gas and Transportation. Products are available for shipment 24 hours a day, supported by 49 manufacturing facilities throughout the world, a global distribution network and 25 company-owned stocking service centers. Our commitment to you is impeccable customer service. To meet your specific requirements, we offer a broad range of programs designed to reduce your overall operating costs, streamline manufacturing, improve productivity, manage inventory, enhance delivery and address safety and environmental issues. For value-added services that generate value-added solutions, team up with Parker!



Aluminum pipes



Connectors



Hose reels and accessories



Quick assembly brackets



Wall brackets



Ball valves and butterfly valves



Couplers



Flexible hoses

Parker Hannifin manufactures a robust piping system with superior operational efficiency perfectly suited for all industrial applications.

Transair is a fast, flexible and easy to modify aluminum pipe system for compressed air, vacuum and inert gas applications. Transair components are reusable and interchangeable, which enables immediate and easy layout modifications. Unlike the performance of steel or copper, which degrades over time due to corrosion, Transair provides clean air quality with optimum flow rate performance.

Transair also offers significant savings on installation, maintenance and operating costs when compared to traditional pipe. The quick connections eliminate the need to thread, solder or glue pipe. With Transair, labor accounts for only 20 percent of installation costs, but with steel or copper, labor accounts for 50 - 80 percent of the installation cost. Transair's aluminum pipe system significantly reduces plant energy costs by increasing efficiency, reducing pressure drops, and eliminating leaks.

Available in 1/2" to 6" pipe sizes, Transair features quick connect technology that secures connections with a simple push and provides a leak-free guarantee. The aluminum pipe is corrosion resistant, ensuring the longevity of equipment and avoiding frequent changes of filtration elements. Transair can also be integrated into existing copper and steel piping systems without compromising performance, making it perfect for upgrades or expansion projects.



Scan QR tag to see a Transair video

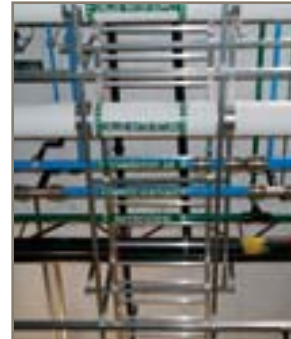
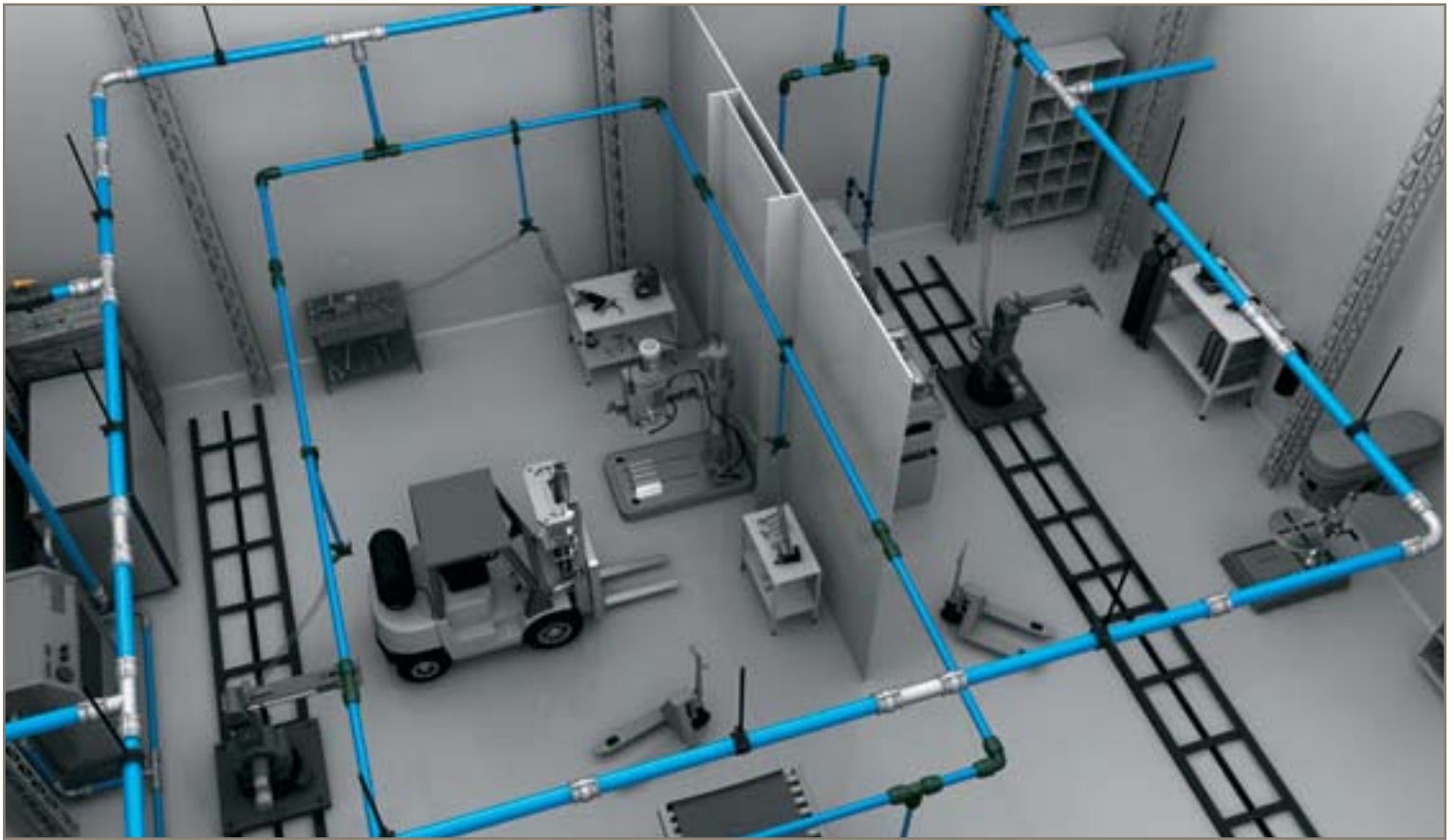

2012 Transair Catalog

Extra care is taken in the preparation of this literature, but Parker is not responsible for any inadvertent typographical errors or omissions. Information in this catalog is only accurate as of the date of publication. For more current information, please visit:

www.parkertransair.com

Questions about Transair

If you have questions about the products contained in this catalog, or their applications, please contact:

Fluid System Connectors Division
Phone: 480-830-7764
Fax: 480-325-3571
www.parkertransair.com

Offer of Sale

The items described in this document and other documents and descriptions provided by Parker Hannifin Corporation, its subsidiaries and its authorized distributors are hereby offered for sale at prices to be established by the seller. This offer and its acceptance are governed by the provision in the "Offer of Sale" detailed on page 90 of this catalog.

⚠ WARNING

FAILURE, IMPROPER SELECTION OR IMPROPER USE OF THE PRODUCTS AND/OR SYSTEMS DESCRIBED HEREIN OR RELATED ITEMS CAN CAUSE DEATH, PERSONAL INJURY AND PROPERTY DAMAGE.

This document and other information from Parker Hannifin Corporation, its subsidiaries and authorized distributors provide product and/or system options for further investigation by users having technical expertise. The user, through its own analysis and testing, is solely responsible for making the final selection of the system and components and assuring that all performance, endurance, maintenance, safety and warning requirements of the application are met. The user must analyze all aspects of the application, follow applicable industry standards, and follow the information concerning the product in the current product catalog and in any other materials provided from Parker or its subsidiaries or authorized distributors. To the extent that Parker or its subsidiaries or authorized distributors provide component or system options based upon data or specifications provided by the user, the user is responsible for determining that such data and specifications are suitable and sufficient for all applications and reasonably foreseeable uses of the components or systems.

> Contents



> Introduction

Competitive advantage	05
Technical specifications	06
Materials	07
Connection technology	08
Certifications and guarantees	09
Services and tools	10
Technical information	11

> Products catalog

Rigid aluminum pipe	15
Flexible hose	17
Pipe-to-pipe and threaded connectors	18
Simple reducing brackets	27
Quick assembly brackets	28
Pressurized system outlets	29
Wall brackets	30
Valves	32
Tools	34
Fixture accessories	38
Hose reels	40
Automatic couplers	41

> Installation guide

Installation instructions	45
Aluminum pipe	47
Pipe-to-pipe connectors	53
Quick assembly brackets	64
Flexible hose	70
Fixture accessories	75
Practical information	79
Transair in use	86

Part numbers index	88
Offer of sale	90

> Competitive advantage



A proven technology with impeccable benefits

Transair offers the advantages of being lightweight, strong and resistant to corrosion. And, Transair is an environmentally sustainable and responsible product that reduces the carbon footprint by 80 percent over steel piping installations. The materials used to produce Transair pipe and fittings are 100 percent recyclable and guaranteed silicone free.

Transair's quick connection technology also reduces energy consumption, improves operational efficiencies and minimizes installation and maintenance costs.

Clean air with optimal flow rate

The clean air quality and "full bore" design of Transair provides optimal machine and tool efficiency. Transair's aluminum pipe ensures a total absence of corrosion. The inner pipe surface consistently delivers clean compressed air. Transair prevents problems caused by rust, which affects steel systems.

Transair aluminum pipe ensures higher longevity of equipment and avoids frequent changes of filtration elements due to its consistent clean quality air from compressor outlets to machines.

The "full bore" design of Transair's components, the low friction coefficient of aluminum pipe, and the sealing characteristics of the system ensure optimal and constant flow throughout. Its innovative technology provides better performance in terms of improved flow and reduced pressure drop.

Significant energy savings

Compressed air represents one of the largest opportunities for immediate energy savings. Plant management is often surprised to hear that compressed air can represent 20 - 50 percent of a plant's electric bill. Using a specifically designed and efficient compressed air piping system can reduce your plant's energy bill by 30 - 60 percent within 24 months.

For instance, a large industrial plant recently redesigned its compressed air system with Transair, accounting for 35 percent savings in the plant's monthly energy bill, which paid for the system in 15 months. The plant continues to save by:

- Increased air system reliability
- Reduced maintenance cost and extended equipment life
- Reduced system downtime and increased production rates

Quick connect technology

Easy to install and modify, Transair is the most versatile compressed air piping system available. With Transair, labor accounts for only 20 percent of installation costs, but with steel or copper, labor accounts for 50 - 80 percent of the installation cost.

Transair's components are also reusable and interchangeable and enable manufacturing plant personnel to implement many layout changes within minutes, instead of hours. This ease of use minimizes downtime and increases plant productivity and efficiency.

The connection is simply pushed or bolted together, which enables disassembly when required unlike other connection technologies that are permanently crimped or welded.

<p style="text-align: center;">Suitable fluids</p> <ul style="list-style-type: none"> • compressed air (dry, wet, lubricated) • vacuum • inert gases <p>(Please consult us for other fluids)</p>	<p style="text-align: center;">Max. working pressure</p> <p>188 psi from -4°F to +140°F 232 psi from -4°F to +115°F (*Max. working pressure for 6" is 188 psi)</p>	<p style="text-align: center;">Temperature range</p> <p>Working: -4°F to +140°F Storage: -40°F to +176°F</p>
<p style="text-align: center;">Resistance to</p> <ul style="list-style-type: none"> • corrosion • aggressive environments • mechanical shocks • thermal variations • mineral compressor oils • synthetic compressor oils • compressor oil carry over • ultraviolet (UV) 		<p style="text-align: center;">Vacuum level</p> <p>98.7 % (29.6" Hg)</p>

Eco-friendly product design

Recent trends reveal that the interest in and demand for green building designs, materials, and products has greatly increased - and will only continue to do so in the coming years. Parker understands this growing focus on sustainable buildings, and as a result the material used to manufacture Transair pipe and fittings are 100 percent recyclable and meet the requirements set by the U.S. Green Building Council for Leadership in Energy and Environmental Design (LEED) certification credits.



Transair piping systems have been specifically designed to ensure a lower impact on the environment with a low carbon footprint when compared to traditional piping systems. In a life cycle analysis, from production of raw materials to end of product life, the use of a six inch Transair pipe system is five times less harmful to the environment than a traditional steel pipe system.

Ideal for aggressive environments

Dust and outdoor installations widely accelerate the deterioration of compressed air systems. To combat these elements, Transair has specifically powder coated the outside of the pipe to enhance mechanical, physical and chemical properties. Furthermore, aluminum is naturally resistant to corrosion, which ensures extended longevity of equipment and can help to avoid frequent changes of filter elements.

Transair's benefits include:

- Quick connection technology
- Modular and reusable
- No corrosion
- Full-bore design
- Lower installation costs
- Optimum flow rate
- Leak-free guarantee
- Immediate pressurization
- Lightweight



> Materials

	Ø 16.5 [1/2"] - Ø 25 [7/8"] - Ø 40 [1 1/2"]	Ø 63 [2 1/2"]		Ø 76 [3"] - Ø 100 [4"] - Ø 168 [6"]
1013A	powder coated alumium	powder coated alumium	TA16	powder coated alumium
1016A	powder coated alumium	powder coated alumium	ER01	zinc steel & rubber
1001E Air	hose & coating: black SBR reinforcement: synthetic braiding	hose & coating: black SBR reinforcement: synthetic braiding	EX01	stainless steel
1001E vacuum	hose & coating: black SBR/NBR reinforcement: spiral steel wire	hose & coating: black SBR/NBR reinforcement: spiral steel wire	EW05	seal: EPDM
4002 - 4012	polyamide with fiberglass	body: polyamide with fiberglass nut: treated aluminum	FP01	hose & connector: black SBR/NBR reinforcement: spiral steel wire
4088 - 4099	body: treated brass nut: engineering grade plastic	-	RA02 - RA04 - RA12	treated aluminum
Anti whip-lash strap	steel			
6602 - 6604	polyamide with fiberglass	treated aluminum	RA25 - RA31 - RA66	treated aluminum
6605	body: treated brass nut: polymer HR / NBR	body: treated brass nut: polymer HR / NBR	RP01	body & pushing ring: polyamide with fiberglass - seal: NBR
6606	polyamide with fiberglass	treated aluminum	RR01	clamp: treated steel (6" treated aluminum) cartridge: polyamide with fiberglass seal: NBR
6609	body: treated brass nut: polymer HR / NBR	body: treated brass nut: treated aluminum / NBR	RR21	treated brass
6611	treated brass	-	RR63	body: treated iron - seal: NBR
6612	polyamide with fiberglass	treated aluminum	RX02	stainless steel 304
6621	treated aluminum	-	RX04	stainless steel 304
6625	polyamide with fiberglass	treated aluminum	RX12	stainless steel 304
6636 - 6638 - 6640	body: treated brass nut: polymer HR / NBR	-	RX20	stainless steel 304
6642	treated brass	-	RX24	stainless steel 304
6651	body: treated brass nut: polyamide with fiberglass	-	RX25	stainless steel 304
6653	body: treated brass nut: polymer HR	-	RX30	stainless steel 304
6663	body: polyamide with fiberglass insert: brass	body: polyamide with fiberglass insert: brass	RX63	stainless steel 304
6662	polyamide with fiberglass	polymere HR	RX64	stainless steel 304
6666	body: treated brass nut: polyamide with fiberglass	treated aluminum	RX66	stainless steel 304
6675 - 6679 - 6689	body: treated brass nut: polymer HR / NBR	-	VR02	body: iron disc & shaft: stainless steel
6676	polyamide with fiberglass	body: treated aluminum nut: polymer HR	Bracket	zinc steel - rubber EPDM
6684	body: treated brass - nut: polyamide with fiberglass			
6688 - 6691	treated brass			
6694 - 6696	body: treated brass - nut: polymer HR - seal: NBR			
EA98	body: treated iron - ball valve: plated brass			
RA68 - RA69	polyamide with fiberglass			
Clip - Spacer	polyamide with fiberglass			
0169 Adaptor	brass			
Composite coupler	body: polymer HR / Zamac - sleeve: polymer HR - spring and ball bearings: stainless steel - seal: nitrile - probe: treated steel			
Hose reel	metal case - fixing: metal			
Blowgun	reinforced polyamide - treated aluminum - insert: brass			

> Connection technology

Transair's innovative technology enables rapid and easy assembly with quick connection of components to the aluminum pipe. This technology takes into account the specific requirements of each diameter and provides the user with an optimum safety coefficient and easy connection.

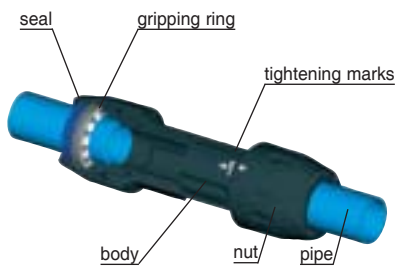

$\text{Ø } 16.5$ (1/2") - $\text{Ø } 25$ (7/8") - $\text{Ø } 40$ (1 1/2")

Pipe-to-pipe and male connectors in $\text{Ø } 16.5$, $\text{Ø } 25$ and $\text{Ø } 40$ can be immediately connected to Transair pipe - simply push the pipe into the connector up to the connection mark. The gripping ring of each fitting is then automatically secured and the connection is safe.

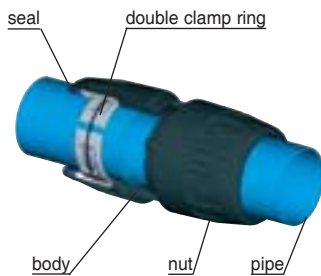

$\text{Ø } 63$ (2 1/2")

Pipe-to-pipe and male connectors in $\text{Ø } 63$ can be quickly connected to Transair aluminum pipe by means of a double clamp ring. This secures the connection between the nut and the pipe - tightening of the nuts secures the final assembly.

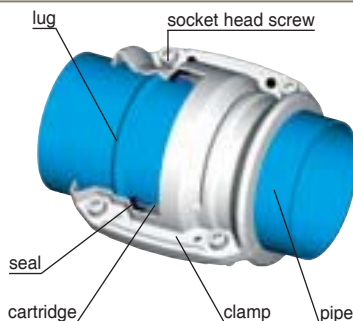

$\text{Ø } 76$ (3") - $\text{Ø } 100$ (4") - $\text{Ø } 168$ (6")

Pipe-to-pipe and male connectors in $\text{Ø } 76$, $\text{Ø } 100$ and $\text{Ø } 168$ can be quickly connected to Transair aluminum pipe. Position the pipes to be connected within a Transair cartridge and close/tighten a Transair clamp.



>Certifications and guarantees

	<p>ISO 9001 version 2000</p> <p>Parker Hannifin is certified ISO 9001 version 2000 and operates a Quality Management System in order to ensure the level of quality and service that is expected by its customers.</p>		<p>TÜV certification</p> <p>A product certified TÜV is a pledge of safety and quality. The Group TÜV thus certifies independent test results – in particular, the properties of the products and the standards whereby they were examined.</p>
	<p>ASME B31.1/B31.3 certification</p> <p>Transair meets the requirement of ASME B31.1 and B31.3 - which stipulates "the minimum requirements for the design, materials, fabrication, erection, test and inspection of power and auxiliary piping systems for industrial institutional plants" as "non boiler external piping".</p>		<p>Qualicoat certification</p> <p>Qualicoat certification is a guarantee of the quality of the lacquer finish applied to Transair aluminum pipe.</p>
	<p>ISO 8573 certification</p> <p>ISO 8573 is the international standard related to the quality of compressed air. Conformance to the ISO 8573 standard illustrates our commitment to providing clean dry air and the highest quality engineered piping systems.</p>		<p>10 Year guarantee</p> <p>Parker Hannifin Corporation warrants its Transair products to be free of defects in material and workmanship for a period of ten (10) years from the date of purchase of the products.</p>
	<p>Safety certifications</p> <p>All Transair components are non-flammable with no propagation of flame. Connectors and valves conform to UL94HB standard. Fixing clips conform to UL94V-2 standard. Flexible hoses conform to ISO 8030 / EN 12115 norm. The pipe powder coat finish is classified MO.</p>		<p>CE conformity</p> <p>Transair connectors manufactured by Parker Hannifin should be considered as piping components, which are designed according to sound working practice and therefore conforms to European standard 97/23 CEE - §3.3 (equipment under pressure).</p>

Electrical conductivity: In areas of potential risk, grounding of metallic components are obligatory. A Transair system can be used in such environments by undertaking the appropriate precautions. For more information, please consult us.

>Services and tools

Services

Transair's technical team is at your disposal to study and help design your air system. In particular, we can assist you with:

- Information on Transair products and services
- Quotation and drawing services
- Guidance and training on how to assemble the system
- Advice on "best practices" in order to reduce your consumption of energy
- Ongoing assistance and follow-up
- On-site advisory presence at construction and installation locations

Our customer service representatives will coordinate a quick response for the following:

- Product availability
- Order processing and follow-up
- Delivery time-phasing and modification
- Technical information / specification sheets



Online tools

Transair Flow Calculator

Defines the recommended diameter for your project, estimates your pressure drops and gives the maximum flow rate by diameter

Transair Energy Savings Calculator

Evaluates the energy cost of your system and return on investment of a Transair solution

Transair Value Calculator

Illustrates the typical savings achieved by installing Transair in place of traditional steel or copper pipe systems

CAD Drawings

View or download Transair CAD drawings in 2D or 3D online

> Technical

Sizing: Select the Transair diameter for your application based on required flow against pressure drop. Estimated values for: a closed loop system, a pressure of 115 psi with 5% pressure drop.

Flow Rate			Length (ft)										Compressor (hp)	
Nm ³ /h	NI/min	cfm	165	330	430	990	1700	2500	3300	4300	4300	6600		
10	167	6	16.5	16.5	16.5	16.5	25	25	25	25	25	25	1	
30	500	18	16.5	25	25	25	25	40	40	40	40	40		
50	833	29	25	25	25	40	40	40	40	40	40	40		10 - 40
70	1167	41	25	25	25	40	40	40	40	40	40	40		
100	1667	59	25	40	40	40	40	40	40	40	63	63	63	
150	2500	88	40	40	40	40	40	40	63	63	63	63	63	
250	4167	147	40	40	40	63	63	63	63	63	63	63	76	
350	5833	206	40	40	63	63	63	63	63	63	76	76	76	40 - 100
500	8300	294	40	63	63	63	63	76	76	76	100	100	100	
750	12500	441	63	63	63	76	76	100	100	100	100	100	100	
1000	16667	589	63	63	76	76	100	100	100	100	100	100	168	100 - 425
1250	20833	736	63	76	76	100	100	100	100	168	168	168	168	
1500	25000	883	63	76	76	100	100	100	168	168	168	168	168	
1750	29167	1030	76	76	100	100	100	168	168	168	168	168	168	
2000	33333	1177	76	76	100	100	168	168	168	168	168	168	168	
2500	41667	1471	76	100	100	100	168	168	168	168	168	168	168	
3000	50000	1766	100	100	100	168	168	168	168	168	168	168	168	
3500	58333	2060	100	100	100	168	168	168	168	168	168	168	168	
4000	66667	2354	100	100	168	168	168	168	168	168	168*	168*	168*	
4500	75000	2649	100	100	168	168	168	168	168	168*	168*	168*	168*	
5000	83333	2943	100	168	168	168	168	168	168	168*	168*	168*	168*	>425
5500	91667	3237	100	168	168	168	168	168	168*	168*	168*	168*	168*	
6000	100000	3531	100	168	168	168	168	168*	168*	168*	168*	168*	168*	
6500	108333	3826	168	168	168	168	168	168*	168*	168*	168*	168*	168*	
7000	116667	4120	168	168	168	168	168	168*	168*	168*	168*	168*	168*	

*Pressure drop >5%



Example

- Main system length (ring main): 990 ft
- Compressor power: 40 hp
- Required flow rate: 147 cfm
- Working pressure: 115 psi

Result: The most suitable Transair diameter is: Ø 63.

Flow rates and pressure drop: Measurements provided by the official French testing body CETIM - Centre Technique des Industries Mecaniques. Charts are based on a 100' straight Transair line.

Maximum flow rate with 5% pressure drop (To convert to cfm, use a coefficient of 0.588.)

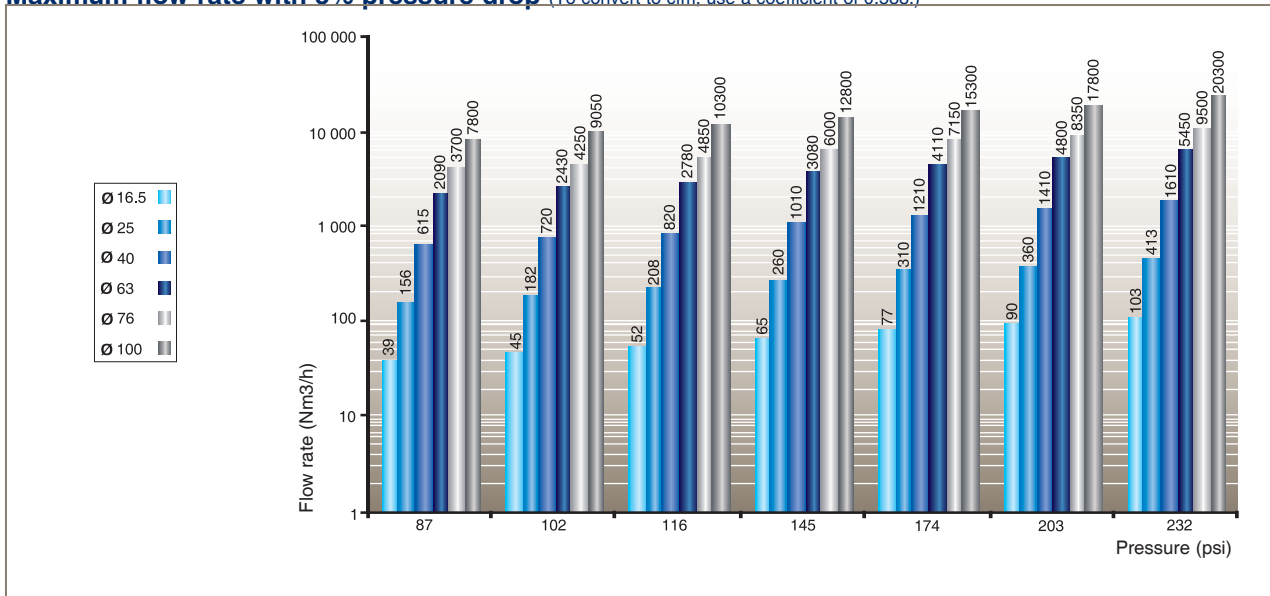

Maximum flow rate with 1.45 psi pressure drop. (To convert to cfm, use a coefficient of 0.588.)

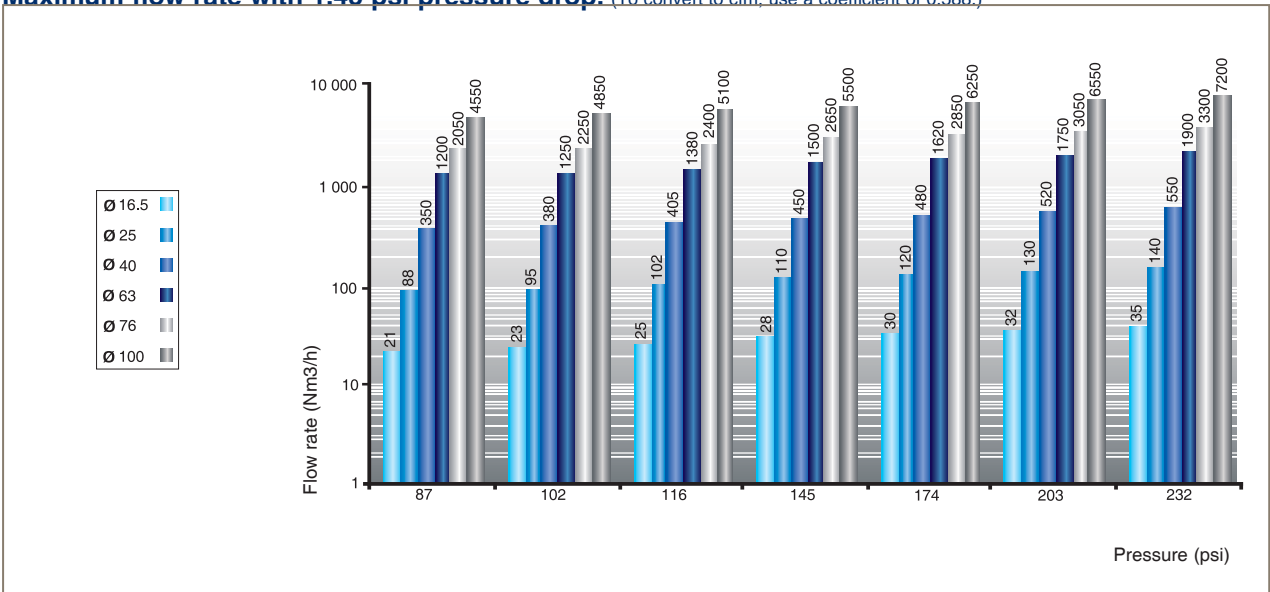

> Notes



A series of horizontal dotted lines for taking notes.

> Products catalog



	<u>Rigid aluminum pipe</u>	15
	<u>Flexible hose</u>	17
	<u>Pipe-to-pipe and threaded connectors</u>	18
	<u>Simple reducing brackets</u>	27
	<u>Quick assembly brackets</u>	28
	<u>Pressurized system outlets</u>	29
	<u>Wall brackets</u>	30
	<u>Ball valves and butterfly valves</u>	32
	<u>Tools</u>	34
	<u>Fixture accessories</u>	38
	<u>Hose reels</u>	40
	<u>Automatic couplers</u>	41

> Rigid aluminum pipe

- > Clean air
- > Optimum flow rate performance
- > Lightweight
- > QUALICOAT certified surface finish
- > Three colors: blue (RAL 5012/BS1710), grey (RAL 7001), and green (RAL 6029) (other colors: please consult us)
- > Suitable fluids: compressed air, vacuum, nitrogen, argon (other fluids: please consult us)

- > Max. working pressure:
 - 188 psi from -4°F to +140°F
 - 232 psi from -4°F to +115°F
 (please consult us for higher temperature requirements)
- > Vacuum: 98.7% (29.6" Hg)
- > Working temperature: -4°F to +140°F
- > Extruded pipe (conforms to EN 755.2, EN 755.8 and EN 573.3 standards)

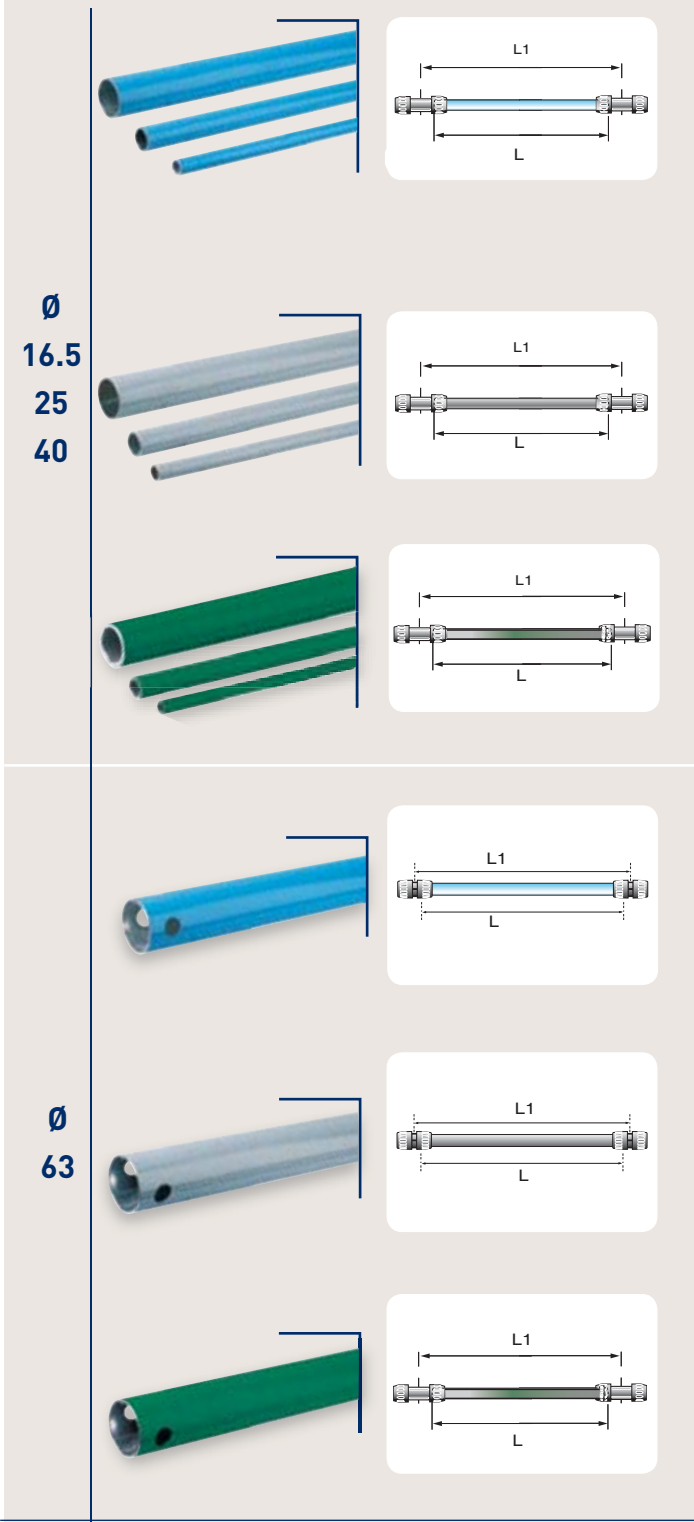

Blue pipe

Transair	ØOD (mm)	ØOD (in)	L1 (ft)	L (ft)
1013A17 04 00	16.5	1/2	10	9' 9 1/4"
1004A17 04	16.5	1/2	15	14' 9 1/2"
1013A25 04 00	25	7/8	10	9' 9 1/4"
1016A25 04 00	25	7/8	20	19' 9 3/4"
1013A40 04 00	40	1 1/2	10	9' 7 1/2"
1016A40 04 00	40	1 1/2	20	19' 7 1/2"

Grey pipe

Transair	ØOD (mm)	ØOD (in)	L1 (ft)	L (ft)
1013A17 06 00	16.5	1/2	10	9' 9 1/4"
1016A25 06 00	25	7/8	20	19' 9 3/4"
1016A40 06 00	40	1 1/2	20	19' 7 1/2"

Green pipe

Transair	ØOD (mm)	ØOD (in)	L1 (ft)	L (ft)
1004A17 02	16.5	1/2	15	14' 9 1/2"
1016A25 02 00	25	7/8	20	19' 9 3/4"
1016A40 02 00	40	1 1/2	20	19' 7 1/2"

Blue pipe

Transair	ØOD (mm)	ØOD (in)	L1 (ft)	L (ft)
1013A63 04	63	2 1/2	10	9' 7 1/2"
1016A63 04	63	2 1/2	20	19' 7 1/8"

Grey pipe

Transair	ØOD (mm)	ØOD (in)	L1 (ft)	L (ft)
1016A63 06	63	2 1/2	20	19' 7 1/8"

Green pipe

Transair	ØOD (mm)	ØOD (in)	L1 (ft)	L (ft)
1016A63 02	63	2 1/2	20	19' 7 1/8"

Ø
76
100

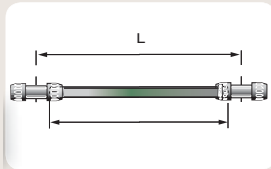
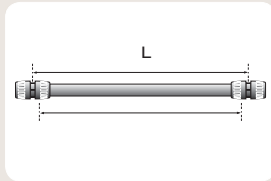
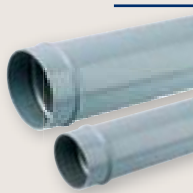
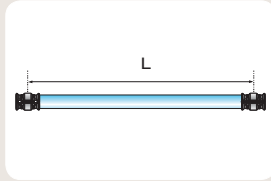

Ø
168

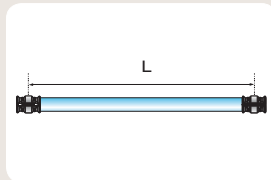

Blue pipe

Transair	ØOD (mm)	ØOD (in)	L (ft)
TA16 L1 04	76.3	3	20
TA16 L3 04	101.8	4	20

Grey pipe

Transair	ØOD (mm)	ØOD (in)	L (ft)
TA16 L1 06	76.3	3	20
TA16 L3 06	101.8	4	20

Green pipe

Transair	ØOD (mm)	ØOD (in)	L (ft)
TA16 L1 02	76.3	3	20
TA16 L3 02	101.8	4	20

Blue pipe

Transair	ØOD (mm)	ØOD (in)	L (ft)
TA16 L8 04	168.3	6	20

Pipe sizes:	16.5 mm (1/2")
	25 mm (7/8")
	40 mm (1 1/2")
	63 mm (2 1/2")
	76.3 mm (3")
	101.8 mm (4")
	168.3 mm (6")

> Flexible hose

- > Compressor outlets (absorption of vibration)
- > To bypass obstacles and join different levels
- > Expansion loops
- > Max. working pressure for flexible hose used for compressed air:
 - 188 psi from -4°F to +140°F
 - 232 psi from -4°F to +115°F (please consult us for higher temperature requirements)

- > Max. working pressure for flexible hose used for vacuum: 145 psi
- > Vacuum: 98.7% (29.6" Hg)
- > Working temperature: -4°F to +140°F
- > Resistant to mineral and synthetic compressor oils
- > Fire resistant (conforms to ISO 8030 standard for compressed air flexible hose and to EN 12.115 standard for vacuum flexible hose)

Ø
25
40

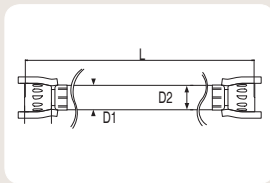
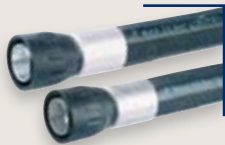

Flexible hose for compressed air systems

Transair	OD (mm)	OD (in)	L (ft)	Min. bend radius (in)	For use with Transair pipe diameter
1001E25 00 01	38	7/8	1' 4"	4	25
1001E25 00 03	38	7/8	5'	4	25
1001E25 00 04	38	7/8	6' 7"	4	25
1001E40 00 02	54	1 1/2	3' 3"	16	40
1001E40 00 04	54	1 1/2	6' 7"	16	40
1001E40 00 05	54	1 1/2	9' 10"	16	40

Flexible hose for vacuum systems

Transair	OD (mm)	OD (in)	L (ft)	Min. bend radius (in)	For use with Transair pipe diameter
1001E25V00 01	36	7/8	1'4"	3	25
1001E25V00 03	36	7/8	5'	3	25
1001E25V00 04	36	7/8	6'7"	3	25
1001E40V00 07	52	1 1/2	3'3"	6 1/2	40
1001E40V00 04	52	1 1/2	6'7"	6 1/2	40
1001E40V00 05	52	1 1/2	9'10"	6 1/2	40

Ø
63

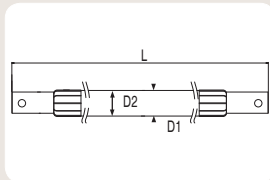
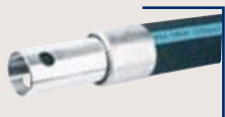

Flexible hose for compressed air systems

Transair	OD (mm)	OD (in)	L (ft)	Min. bend radius (in)	For use with Transair pipe diameter
1001E63 00 08	79	2 1/2	4'7"	12	63
1001E63 00 05	79	2 1/2	9'10"	25	63
1001E63 00 06	79	2 1/2	13'1"	25	63

Flexible hose for vacuum systems

Transair	OD (mm)	OD (in)	L (ft)	Min. bend radius (in)	For use with Transair pipe diameter
1001E63V00 05	76	2 1/2	9'10"	10	63
1001E63V00 06	76	2 1/2	13'1"	10	63

Ø
76
100

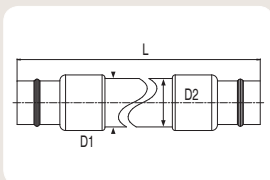

Flexible hose for compressed air and vacuum systems

Transair	OD (mm)	OD (in)	L (ft)	Min. bend radius (in)	For use with Transair pipe diameter
FP01 L1 01	91	3	4'11"	14	76
FP01 L1 02	91	3	6'6"	14	76
FP01 L3 02	116	4	6'6"	20	101
FP01 L3 03	116	4	9'10"	20	101

Use two connectors RR01 to connect flexible hoses FP01 to Transair pipe.

Anti whip-lash strap

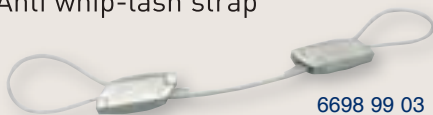

6698 99 03

Prevents whip-lash should Transair flexible hose be disconnected while under pressure. Conforms to ISO 4414 safety standard.

> Pipe-to-pipe and threaded connectors

The range of Transair pipe-to-pipe and stud connectors provides versatility of design and helps to overcome constraints often encountered with the structure of industrial buildings.

- > Quick connection
- > Full bore design*

- > Interchangeable and reusable
- > Non-flammable materials (UL94-HB standard)

*Consistent inner diameter for both pipe and connectors.



Pipe-to-pipe connector

Transair	ØD	ØG	L	Z
6606 17 00	16.5	34.0	120.5	33.0
6606 25 00	25	44.5	151.5	48.0
6606 40 00	40	67.0	205.0	57.0

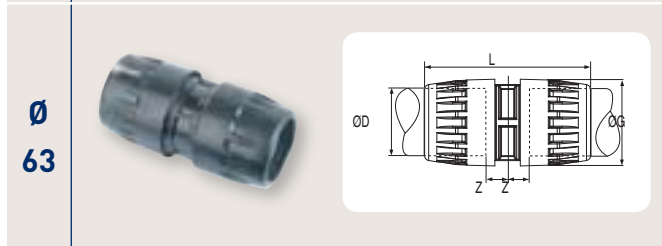

Transair	ØD	ØG	L	Z
6606 63 00	63	91.0	171.5	25.0

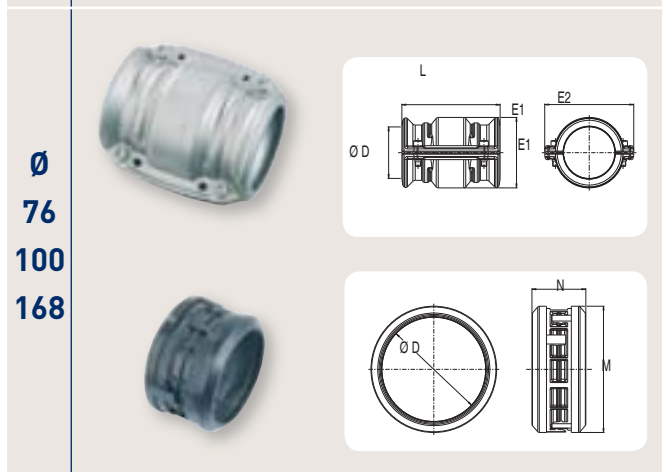

Pipe-to-pipe connector (clamp and cartridge)

Transair	ØD	L	E1	E2
RR01 L1 00	76	146	104	132
RR01 L3 00	100	146	128	157
RR01 L8 00	168	139	212	230

Cartridge (spare part)

Transair	ØD	M	N
RP00 L1 00	76	88.7	51.4
RP00 L3 00	100	123	52.7

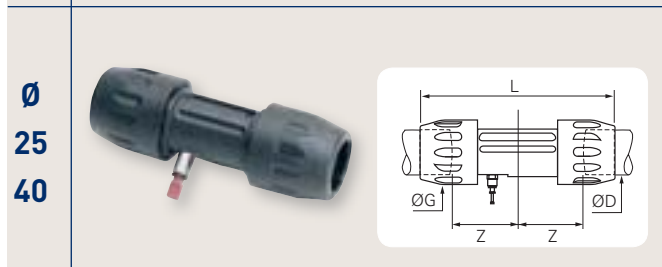

Pipe-to-pipe connector with vent

Transair	ØD	ØG	L	Z
6676 25 00	25	44.5	151.5	48.0
6676 40 00	40	67.0	205.0	57.0

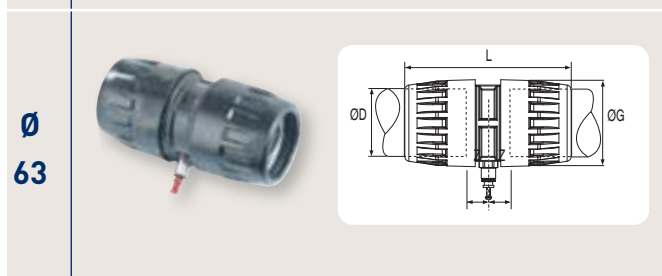

Transair	ØD	ØG	L	Z
6676 63 00	63	91.0	171.5	25.0

Model supplied with 1/4" threaded fitting and Ø 8 mm push-in connection, complete with blanking plug.

> Pipe-to-pipe and threaded connectors

Ø
16.5
25
40

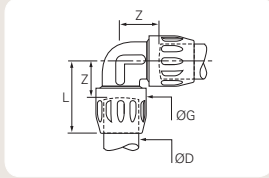

90° elbow

Transair	ØD	ØG	L	Z
6602 17 00	16.5	34.0	58.0	31.0
6602 25 00	25	44.5	68.0	40.0
6602 40 00	40	67.0	107.0	62.0

Ø
63

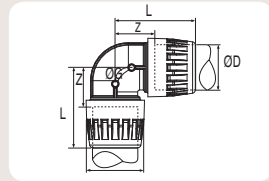

Transair	ØD	ØG	L	Z
6602 63 00	63	91.0	122.0	61.0

Ø
76
100

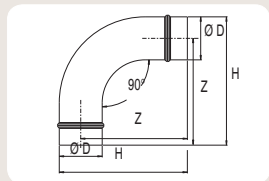

Transair	ØD	H	Z
RX02 L1 00	76	227	189
RX02 L3 00	100	278	221

Use two connectors (RR01) to connect 90° elbow (RX02) to Transair pipe.

Ø
168

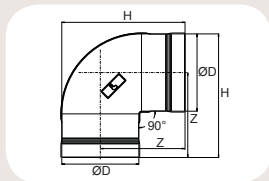

Transair	ØD	H	Z
RA02 L8 00	168	269.2	185

Use two connectors (RR01) to connect 90° elbow (RA02) to Transair pipe.

Ø
16.5
to
63

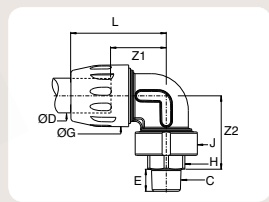

Male threaded 90° elbow, NPT

Transair	ØOD (mm)	C	E	H	ØG	ØJ	L	Z1	Z2
6609 17 14	16.5	1/4"	9.5	17	34	34	58	31	41.2
6609 17 22	16.5	1/2"	15	23	34	34	58	31	46.5
6609 25 22	25	1/2"	15	27	44.5	45.5	69.5	40.5	53
6609 25 28	25	3/4"	15	27	44.5	45.5	69.5	40.5	53
6609 25 35	25	1"	16	36	44.5	45.5	69.5	40.5	55
6609 40 35	40	1"	16	41	67	68.5	107	62	75
6609 40 43	40	1 1/4"	21.5	50	67	68.5	107	62	81
6609 40 50	40	1 1/2"	24.5	50	67	68.5	107	62	81
6609 40 44	40	2"	23	60	67	68.5	107	62	81
6609 63 41	63	2 1/2"	27	80	91	91	124	61	106
6609 63 46	63	3"	30	95	91	91	124	61	83



45° elbow

Transair	ØD	ØG	L	Z
6612 25 00	25	44.5	57.0	29.0
6612 40 00	40	67.0	90.0	45.0



Transair	ØD	ØG	L	Z
6612 63 00	63	91.0	100.0	61.0

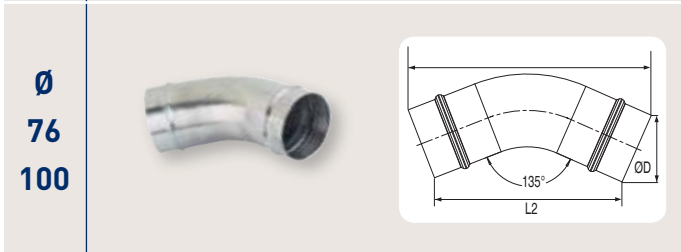

Transair	ØD	L1	L2
RX12 L1 00	76	235.5	151.4
RX12 L3 00	100	271.4	184.3

Use two connectors (RR01) to connect 45° elbow (RX12) to Transair pipe.



Transair	ØD	L1	Z
RA12 L8 00	168	310.5	1

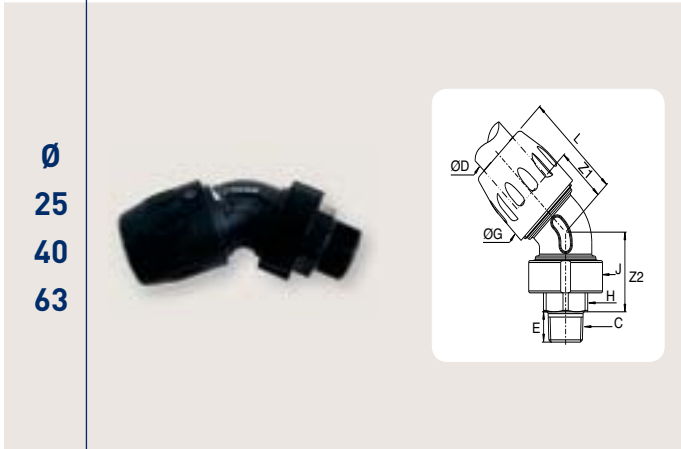

Male threaded 45° elbow, NPT

Transair	ØOD (mm)	C	E	H	ØG	ØJ	L	Z1	Z2
6619 25 22	25	1/2"	15	27	44.5	45.5	61.5	32.5	42
6619 25 28	25	3/4"	15	27	44.5	45.5	61.5	32.5	42
6619 25 35	25	1"	16	36	44.5	45.5	61.5	32.5	44
6619 40 35	40	1"	16	41	67	68.5	94	45	58.5
6619 40 43	40	1 1/4"	21.5	50	67	68.5	94	45	64
6619 40 50	40	1 1/2"	24.5	50	67	68.5	94	45	64
6619 40 44	40	2"	23	60	67	68.5	94	45	61
6619 63 40	63	2"	20	70	91	91.0	107	51	78

> Pipe-to-pipe and threaded connectors

Ø
16.5
25
40

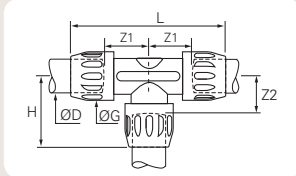

Equal tee

Transair	ØD	G	H	L	Z1	Z2
6604 17 00	16.5	34.0	58.0	120.5	34.0	31.0
6604 25 00	25	44.5	67.5	151.5	48.0	40.0
6604 40 00	40	67.0	102.5	205.0	57.0	57.0

Ø
63

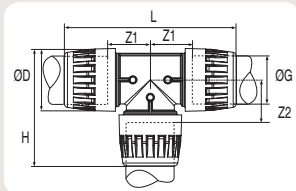

Transair	ØD	G	H	L	Z1	Z2
6604 63 00	63	91.0	122.0	245.0	61.0	61.0

Ø
76
100
168

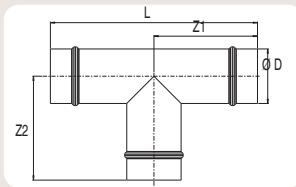

Transair	ØD	L	Z1	Z2
RX04 L1 00	76	290	145	145
RX04 L3 00	100	310	155	135
RA04 L8 00	168	360	180	185

Use three connectors (RR01) to connect equal tees (RX04 and RA04) to Transair pipe.

Ø
63

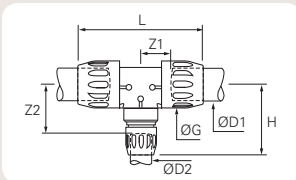

Reducing tee

Transair	ØD1	ØD2	ØG	H	L	Z1	Z2
6604 63 40	63	40	91.0	161.0	245.0	61.0	116.0

Ø
76
100

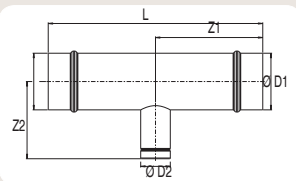

Transair	ØD1	ØD2	L	Z1	Z2
RX24 L1 40	76	40	290	145	104
RX24 L1 63	76	63	290	145	163
RX24 L3 40	100	40	310	155	116.5
RX24 L3 63	100	63	310	155	175.8
RX04 L3 L1	100	76	310	155	135

Use two connectors (RR01) to connect reducing tees (RX24) to Transair pipes Ø 76 and Ø 100 and to connect pipe-to-pipe connectors (6606) to Transair pipes Ø 40 and Ø 63.

Ø
168

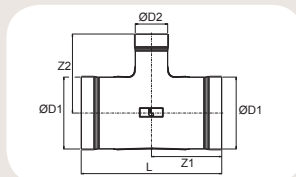

Transair	ØD1	ØD2	L	Z1	Z2
RA04 L8 L3	168	100	330	165	185
RA04 L8 L1	168	76	330	165	185
RA04 L8 63	168	63	330	165	220

Use two connectors (RR01) to connect reducing tees (RA04) to Transair pipes Ø 168, Ø 100 and Ø 76 and to connect pipe-to-pipe connectors (6606) to Transair pipe Ø 63.

Ø
76
100

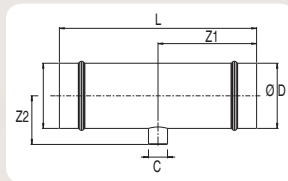

Threaded tee

Transair	ØD	C (in)	L	Z1	Z2
RX20 L1N04	76	1/2	290	145	63
RX20 L3N04	100	1/2	310	155	75.8

Use two connectors (RR01) to connect threaded tees (RX20) to Transair pipe.

Ø
16.5
25
40

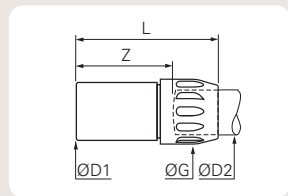

Plug-in reducer

Transair	ØD1	ØD2	ØG	Z	L
6666 17 25	25	16.5	34.0	50.0	77.0
6666 25 40	40	25	44.5	71.0	99.0

Ø
63

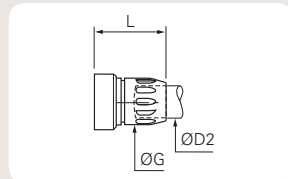

Transair	ØD1	ØD2	ØG	L
6666 40 63	63	40	67.0	112.5

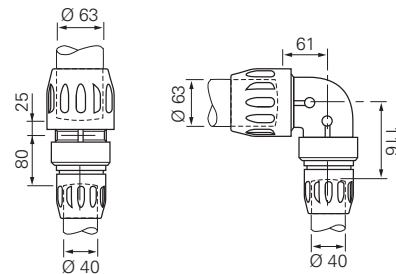

Ø
76
100

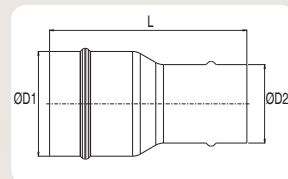
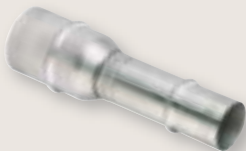

Transair	ØD1	ØD2	L
RX64 L1 63	76	63	230
RX64 L3 63	100	63	250
RX66 L3 L1	100	76	192.5

Use one connector (RR01) to connect plug-in reducers (RX64) to Transair pipes Ø 76 or Ø 100 and one connector (6606) to connect to Transair pipe Ø 63.

Ø
168

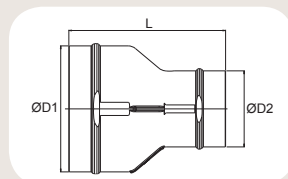

Transair	ØD1	ØD2	L
RA66 L8 L3	168	100	210
RA66 L8 L1	168	76	210

Use one connector (RR01) to connect plug-in reducers (RA66) to Transair pipe.

> Pipe-to-pipe and threaded connectors

Ø
16.5
25
40

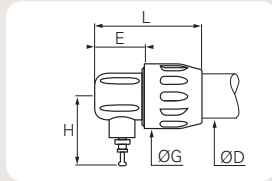

Vented end cap

Transair	ØD	E	ØG	H	L
6625 17 00	16.5	25.5	34.0	45.5	62.5
6625 25 00	25	33.0	44.5	47.0	75.0
6625 40 00	40	34.5	67.0	55.0	98.5

16.5mm: supplied with LF3000 6mm plus. Model Ø 25, Ø 40 and Ø 63: supplied with LF3000 5/16" (8mm) plug.

Ø
63

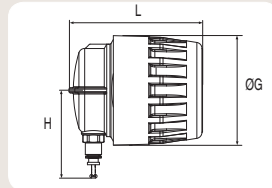

Transair	ØD	E	ØG	H	L
6625 63 00	63	31.0	91.0	74.0	111

16.5mm: supplied with LF3000 6mm plug. Model Ø 25, Ø 40 and Ø 63: supplied with LF3000 5/16" (8mm) plug.

Ø
76
100

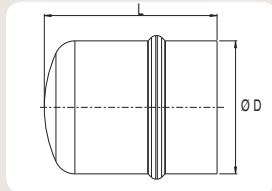

End cap

Transair	ØD	L
RX25 L1 00	76	99.6
RX25 L3 00	100	107.4

Use one connector (RR01) to connect end caps (RX25) to Transair pipe.

Ø
168

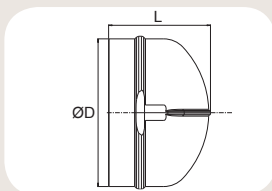

Transair	ØD	L
RA25 L8 00	168	117

Use one connector (RR01) to connect end caps (RA25) to Transair pipe.

Ø
16.5
25
40

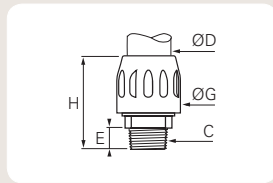

Male threaded connector, NPT thread

Transair	ØD	C	E	ØG	H
6605 17 14	16.5	1/4"	9.5	34.0	62.5
6605 17 22	16.5	1/2"	15.0	34.0	68.0
6605 25 22	25	1/2"	15.0	44.5	70.5
6605 25 28	25	3/4"	15.0	44.5	71.5
6605 25 35	25	1"	16.0	44.5	71.5
6605 40 35	40	1"	16.0	67.0	111.5
6605 40 43	40	1 1/4"	21.5	67.0	111.5
6605 40 50	40	1 1/2"	24.5	67.0	114.5
6605 40 44	40	2"	23.0	67.0	111.5

Ø
63

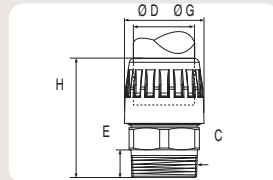

Transair	ØD	C	E	ØG	H
6605 63 44	63	2"	20.0	91.0	118.5
6605 63 41	63	2 1/2"	25.0	91.0	130.5
6605 63 46	63	3"	27	91.0	140.0

Ø
25
40

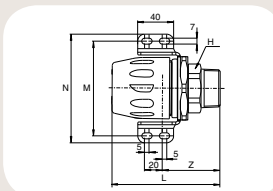

Male threaded connector with fixing plate

Transair	ØD	C	H	L	M	N	Z
6615 25 22	25	1/2"	27	76	66.5	82	44
6615 25 28	25	3/4"	27	77	66.5	82	44
6615 25 35	25	1"	36	77	66.5	82	53
6615 40 43	40	1 1/4"	50	121	84	105	75
6615 40 50	40	1 1/2"	50	121	84	105	75

> Pipe-to-pipe and threaded connectors

Ø
16.5
to
63

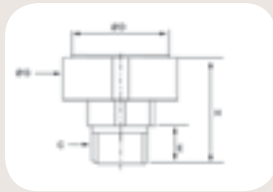

Male stud nut

Transair	ØD	C	E	ØG	H
6611 17 22	16.5	1/2"	9.5	34.0	62.5
6611 25 22	25	1/2"	15.0	34.0	68.0
6611 25 28	25	3/4"	15.0	44.5	70.5
6611 25 35	25	1"	15.0	44.5	70.5
6611 40 35	40	1"	15.0	44.5	71.5
6611 40 43	40	1 1/4"	16.0	44.5	71.5
6611 40 50	40	1 1/2"	16.0	67.0	111.5
6611 40 44	40	2"	21.5	67.0	111.5
6611 63 44	63	2"	23.0	67.0	111.5
6611 63 41	63	2 1/2"	24.5	67.0	114.5

Ø
16.5
25
40

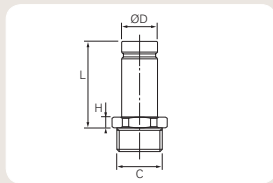

Male adaptor, NPT thread

Transair	ØD (mm)	C (in)	L	H
6621 17 22	16.5	1/2"	42.2	5.0
6621 25 22	25	1/2"	49.0	7.0
6621 25 28	25	3/4"	49.0	7.0
6621 25 35	25	1"	49.0	7.0
6621 40 43	40	1 1/4"	73.7	8.0
6621 40 50	40	1 1/2"	75.7	10.0

Ø
76

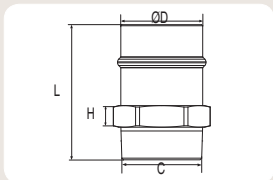

Transair	ØD (mm)	C (in)	L	H
RR21 L1N20	76	2 1/2"	125	20
RR21 L1N24	76	3"	125	20

Use one connector (RR01) to connect male adaptors (RR21) to Transair pipe.

Ø
25
40

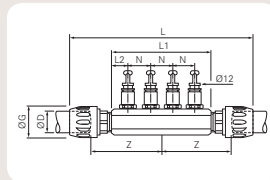

4 port manifold

Transair	ØD	G	L	L1	L2	N	Z
6651 25 12 04	25	44.5	271.0	151.0	23.0	35.0	107.0
6651 40 12 04	40	67.0	400.0	204.0	27.0	50.0	150.0

Supplied with four Ø12 mm plugs.

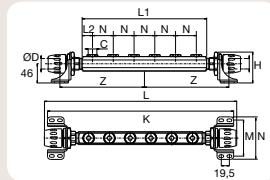

6 port manifold

Transair	ØD	C	L	L1	L2	K	N	Z	H	M
6653 25 22 06	25	1/2"	463	300	25	448	50	204	74	86.5
6653 40 22 06	40	1/2"	526	310	25	469	50	217	83	104.5

Supplied with 1/2" NPT ports.

Ø
76
100
168

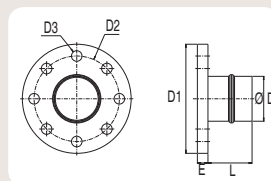

Flange

Transair	ØD	DN	D1	D2	D3	E	L
RX30 L1 00	76	65	185	145	18	10	75
RX31 L1 00	76	80	200	160	18	10	75
RX30 L3 00	100	100	220	180	18	10	75
RX31 L3 00	100	100	228.5	190.5	19	12.7	75
RX31 L8 00	168	150	279	240	22	25	100

RX30 dimensions conform to EN 1092-1 standard and the RX31 dimensions conform to ANSI B16.5 standard.

Flange gasket

Transair	ØD	For use with flange reference
EW05 L1 00	76	RX30/RX31 L1 00
EW05 L3 00	100	RX30/RX31 L3 00
EW05 L8 00	168	RA31 L8 00



Flange bolt kit

Transair	C	L
EW06 00 01	5/8"	60
EW06 00 05	M20	80

Contains eight bolts and eight nuts.



> Simple reducing brackets

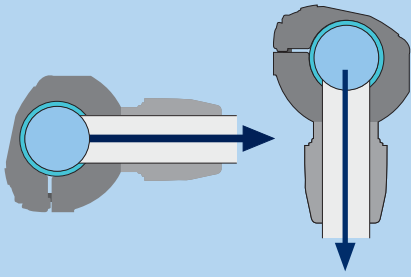

For rigid drops with horizontal take off or for all types of air supply with rigid pipe or flexible hose on an installation which incorporates an efficient air dryer.

- > Optimum flow
- > Compact
- > Well adapted for most original equipment manufacturer (OEM) applications and for use with neutral gases
- > Quick installation without any cutting of pipe

Ø
25
40

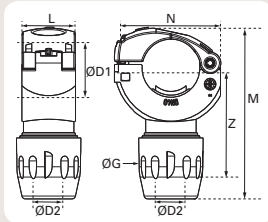

Simple reducing bracket

Transair	ØD1	ØD2	M	G	L	N	Z
RA69 25 17	25	16.5	92	34	37	52	47.5
RA69 40 25	40	25	117	44.5	37	74	61

To drill Transair pipe, use drilling tools 6698 02 01 and 6698 02 02.

Ø
76
100

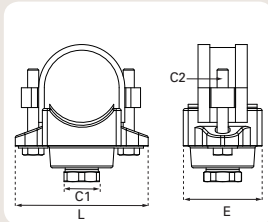

Transair	ØD	C1	C2	E	L
RR63 L1N08	76	1"	M12	50	137
RR63 L3N08	100	1"	M12	80	137

Nitrile Seals. Supplied with Ø 25 - 1" adaptor (6621 25 35). To drill Transair pipe, use drilling tool EW09.

Ø
168

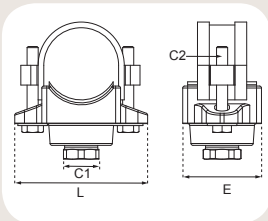

Transair	ØD	C1	C2	E	L
RR63 L8N12	168	1 1/2"	16	90	235
RR63 L8N16	168	2"	16	103	235

For RR63 L8N12 use EW09 0051 drill bit. For RR63 L8N16 use EW09 0064 drill bit.

Ø
25
40

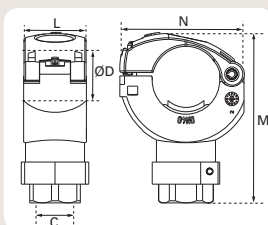

Simple bracket with thread (NPT)

Transair	ØD	C	L	N	M
RA68 25N04	25	1/2"	37	52	86
RA68 40N04	40	1/2"	37	74	100

Supplied with brass plug. To drill Transair pipe, use drilling tools 6698 02 01 and 6698 02 02.

> Quick assembly brackets

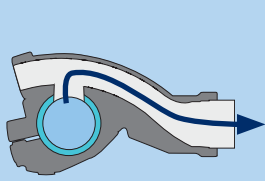

New generation quick assembly brackets are recommended for vertical or horizontal take-offs, using either rigid pipe or flexible hose.

- > Integral water retention device
- > Very high flow
- > Quick installation without any cutting of pipe

Ø
25
40

Quick assembly bracket

Transair	ØD1	ØD2	M	ØG	L	N	Z
6662 25 17	25	16.5	139.5	34	36	63.5	82
6662 25 00	25	25	134	44.5	36	63.5	74
6662 40 17	40	16.5	154	34	37.5	76.5	89
6662 40 25	40	25	149.5	44.5	37.5	76.5	82

To drill Transair pipe, use drilling tools 6698 02 01 and 6698 02 02.

Ø
63

Transair	ØD1	ØD2	M	G	L	N	Z
6662 63 25	63	25	166.5	44.5	50	108.5	75

To drill Transair pipe, use drilling tool 6698 02 02.

Ø
25
40

Quick assembly mini-bracket with female thread, NPT

Transair	ØD1	C	M	L	N
6663 25 22	25	1/2"	117.5	36	63.5
6663 40 22	40	1/2"	132	37.5	76.5

Supplied with brass plug. To drill Transair pipe, use drilling tools 6698 02 01 and 6698 02 02.

Ø
63

Transair	ØD1	C	M	L	N
6663 63 22	63	1/2"	138.9	50	98.5
6663 63 28	63	3/4"	138.9	50	98.5

Supplied with brass plug. To drill Transair pipe, use drilling tool 6698 02 01.

Ø
25
40
63

Quick assembly bracket with pre-assembled ball valve, NPT

Transair	ØD1	C	L	L1	L2	M	N
6668 25 22	25	1/2"	256	32	155	40	23
6668 40 22	40	1/2"	270	39	162	45	31
6668 63 22	63	1/2"	275	63	142	60	48
6668 63 28	63	3/4"	297	63	146	60	48

> Pressurized system outlets

> Ideal for fast assembly of new pressurized outlets, without venting the compressed air system.

> The drilling tool can be used with most standard drills.

We recommend, however, that the pipe system is vented prior to the addition of an outlet. Thanks to the lateral dismantling capability of Transair pipe and the use of quick assembly brackets, this operation can be completed very quickly (less than seven min. for a new outlet) and guarantees the interior cleanliness of the system.

Ø
25
40



Pressurized system bracket

Transair	ØD
EA98 06 01	25
EA98 06 02	40

Bracket with ball valve (1/2" NPT thread)

Ø
63



Transair	ØD
EA98 06 03	63

Bracket with ball valve (1/2" NPT thread)

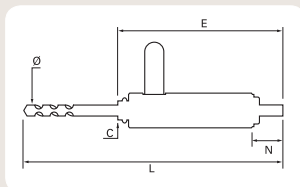

Pressurized system drilling tool

Transair	C	ØD	L	E	N
EA98 06 00	1/2"	13	330.0	154.0	30.5

> Wall brackets

- > 1, 2 or 3 ports
- > For wall or machine mounting
- > Supplied with brass plugs
- > Drain outlet 1/4"

- > Working pressure:
 - 188 psi from -4°F to +140°F
 - 232 psi from -4°F to +115°F (please consult us for higher temperature requirements)
- > Non-flammable (conforms to UL94-HB standard)
- > Vacuum: 98.7% (29.6" Hg)
- > Working temperature: -4°F to +140°F

Ø
16.5
25

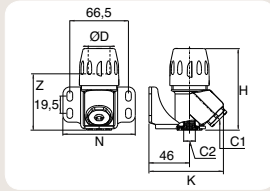

1 port 45° wall bracket, NPT

Transair	ØD	C1	C2	H	Z	K	N
6640 17 22	16.5	1/2"	1/4"	89.5	63.5	84.5	82
6640 25 22	25	1/2"	1/4"	92.5	63.5	84.5	82

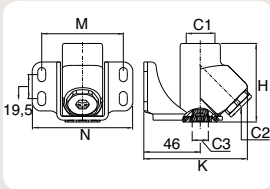

1 port 45° threaded wall bracket, NPT

Transair	C1	C2	C3	H	K	M	N
6642 22 22	1/2"	1/2"	1/4"	64	84.5	66.5	82

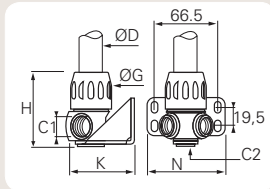

2 port wall bracket

Transair	ØD	C1	C2	G	H	K	N
6684 17 22	16.5	1/2"	1/4"	34	65	74.5	82
6684 25 22	25	1/2"	1/4"	44.5	81	74.5	82

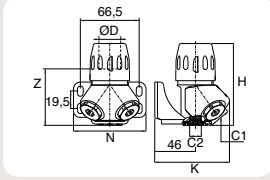

2 port 45° wall bracket, NPT

Transair	ØD	C1	C2	H	Z	K	N
6689 17 22	16.5	1/2"	1/4"	89.5	63.5	84.5	82
6689 25 22	25	1/2"	1/4"	92.5	63.5	84.5	82

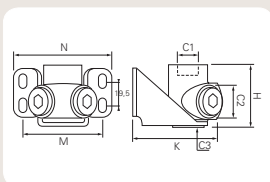

2 port threaded wall bracket

Transair	C1	C2	C3	H	K	M	N
6688 22 22	1/2"	1/2"	1/4"	48	72.5	66.5	82

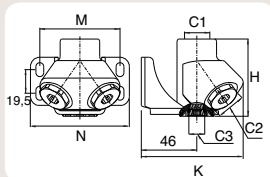

2 port 45° threaded wall bracket, NPT

Transair	C1	C2	C3	H	K	M	N
6691 22 22	1/2"	1/2"	1/4"	64	84.5	66.5	82

> Wall brackets

Ø
25

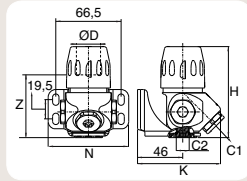

3 port wall bracket, NPT

Transair	ØD	C1	C2	H	Z	K	N
6696 25 22	25	1/2"	1/4"	92.5	63.5	84.5	82

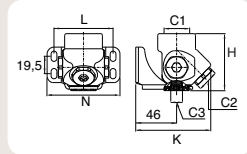

3 port threaded wall bracket, NPT

Transair	C1	C2	C3	H	K	M	N
6636 28 22	3/4"	1/2"	1/4"	64	84.5	66.5	82

Ø
16.5
25

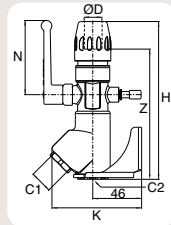

1 port 45° wall bracket with ball valve, NPT

Transair	ØD	C1	C2	H	Z	K	N
6679 17 22	16.5	1/2"	1/4"	148.5	123	84.5	69.5
6679 25 22	25	1/2"	1/4"	173	142	84.5	108.5

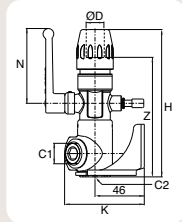

2 port 90° wall bracket with ball valve, NPT

Transair	ØD	C1	C2	H	Z	K	N
6675 17 22	16.5	1/2"	1/4"	137	111.5	74.5	69.5
6675 25 22	25	1/2"	1/4"	163	132	74.5	108.5

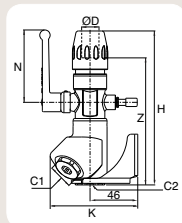

2 port 45° wall bracket with ball valve, NPT

Transair	ØD	C1	C2	H	Z	K	N
6694 17 22	16.5	1/2"	1/4"	148.5	123	84.5	69.5
6694 25 22	25	1/2"	1/4"	173	142	84.5	108.5

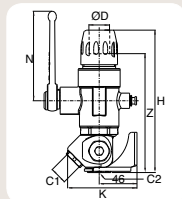







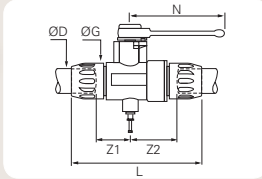

3 port wall bracket with ball valve, NPT

Transair	ØD	C1	C2	H	Z	K	N
6638 25 22	25	1/2"	1/4"	173	142	84.5	108.5

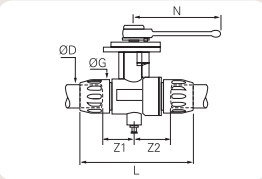
> Ball valves

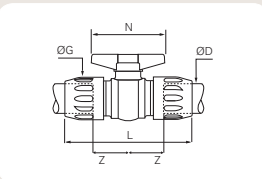
Transair ball valves and butterfly valves placed regularly throughout the system at key locations, such as compressor outlets and upstream of pneumatic tools, allow ease of system isolation and pipe reconfiguration / maintenance.

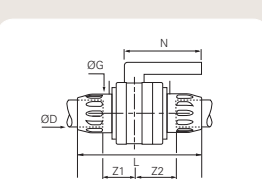
- > Quick connection
- > Available in lockable version (only in 16.5mm and 25mm)
- > Manual or piloted operation (only in 25mm and 40mm)

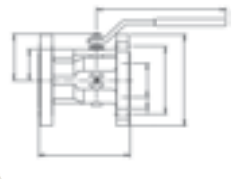
<p>Ø 16.5 25</p>			<p>Double female, vented</p> <table border="1"> <thead> <tr> <th>Transair</th> <th>ØD</th> <th>G</th> <th>L</th> <th>N</th> <th>Z1</th> <th>Z2</th> </tr> </thead> <tbody> <tr> <td>4089 17 00</td> <td>16.5</td> <td>34.0</td> <td>120.0</td> <td>69.5</td> <td>29.0</td> <td>42.0</td> </tr> <tr> <td>4088 25 14</td> <td>25</td> <td>44.5</td> <td>152.0</td> <td>108.5</td> <td>40.0</td> <td>55.0</td> </tr> </tbody> </table> <p>Model 4089 17 00: supplied with Ø6 mm plug. Model 4088 25 14: supplied with Ø8 mm plug.</p>	Transair	ØD	G	L	N	Z1	Z2	4089 17 00	16.5	34.0	120.0	69.5	29.0	42.0	4088 25 14	25	44.5	152.0	108.5	40.0	55.0			
	Transair	ØD	G	L	N	Z1	Z2																				
4089 17 00	16.5	34.0	120.0	69.5	29.0	42.0																					
4088 25 14	25	44.5	152.0	108.5	40.0	55.0																					
		<p>Lockable valve, vented</p> <table border="1"> <thead> <tr> <th>Transair</th> <th>ØD</th> <th>G</th> <th>L</th> <th>N</th> <th>Z1</th> <th>Z2</th> </tr> </thead> <tbody> <tr> <td>4099 17 00</td> <td>16.5</td> <td>34.0</td> <td>121.0</td> <td>69.0</td> <td>29.0</td> <td>42.0</td> </tr> <tr> <td>4099 25 00</td> <td>25</td> <td>44.5</td> <td>151.7</td> <td>108.3</td> <td>40.0</td> <td>55.0</td> </tr> </tbody> </table> <p>Model 4099 17 00: supplied with Ø 6 mm plug. Model 4099 25 00: supplied with Ø 8 mm plug.</p>	Transair	ØD	G	L	N	Z1	Z2	4099 17 00	16.5	34.0	121.0	69.0	29.0	42.0	4099 25 00	25	44.5	151.7	108.3	40.0	55.0				
Transair	ØD	G	L	N	Z1	Z2																					
4099 17 00	16.5	34.0	121.0	69.0	29.0	42.0																					
4099 25 00	25	44.5	151.7	108.3	40.0	55.0																					
<p>Ø 40</p>			<p>Double female valve</p> <table border="1"> <thead> <tr> <th>Transair</th> <th>ØD</th> <th>G</th> <th>L</th> <th>N</th> <th>Z</th> </tr> </thead> <tbody> <tr> <td>4002 40 00</td> <td>40</td> <td>67.0</td> <td>205.0</td> <td>122.0</td> <td>57.0</td> </tr> </tbody> </table>	Transair	ØD	G	L	N	Z	4002 40 00	40	67.0	205.0	122.0	57.0												
Transair	ØD	G	L	N	Z																						
4002 40 00	40	67.0	205.0	122.0	57.0																						
<p>Ø 63</p>			<table border="1"> <thead> <tr> <th>Transair</th> <th>ØD</th> <th>G</th> <th>L</th> <th>N</th> <th>Z1</th> <th>Z2</th> </tr> </thead> <tbody> <tr> <td>4002 63 00</td> <td>63</td> <td>91.0</td> <td>278.0</td> <td>185.0</td> <td>84.0</td> <td>98.0</td> </tr> <tr> <td>4012 63 00*</td> <td>63</td> <td>91.0</td> <td>278.0</td> <td>185.0</td> <td>84.0</td> <td>98.0</td> </tr> </tbody> </table> <p>*lockable</p>	Transair	ØD	G	L	N	Z1	Z2	4002 63 00	63	91.0	278.0	185.0	84.0	98.0	4012 63 00*	63	91.0	278.0	185.0	84.0	98.0			
Transair	ØD	G	L	N	Z1	Z2																					
4002 63 00	63	91.0	278.0	185.0	84.0	98.0																					
4012 63 00*	63	91.0	278.0	185.0	84.0	98.0																					
<p>Ø 76 100</p>			<p>Ball Valve</p> <table border="1"> <thead> <tr> <th>Transair</th> <th>ØD</th> <th>A</th> <th>B</th> <th>D</th> <th>L</th> <th>K</th> <th>R</th> </tr> </thead> <tbody> <tr> <td>VR01 L1 00</td> <td>76</td> <td>102</td> <td>75</td> <td>185</td> <td>170</td> <td>145</td> <td>320</td> </tr> <tr> <td>VR01 L3 00</td> <td>100</td> <td>136</td> <td>104</td> <td>220</td> <td>190</td> <td>180</td> <td>380</td> </tr> </tbody> </table> <p>Nitrile seal. Supplied with fixing bolts.</p>	Transair	ØD	A	B	D	L	K	R	VR01 L1 00	76	102	75	185	170	145	320	VR01 L3 00	100	136	104	220	190	180	380
Transair	ØD	A	B	D	L	K	R																				
VR01 L1 00	76	102	75	185	170	145	320																				
VR01 L3 00	100	136	104	220	190	180	380																				

> Valves

- > Max. working pressure:
 - 188 psi from -4°F to +140°F
 - 232 psi from -4°F to +115°F
 (please consult us for higher temperature requirements)
- > Vacuum: 98.7% (29.6" Hg)
- > Working temperature: -4°F to +140°F

Ø
76
100

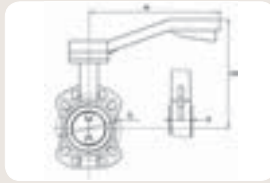

Butterfly valve

Transair	ØD (in)	DN	G	M	N	E
VR02 L1 00	3	80	145	300	250	50
VR02 L3 00	4	100	180	270	210	56

Seal cast in one piece (do not use any flange gasket for mounting with a flange). Model has CE marking. Supplied with fixing bolts. Lockable version. Nitrile seal.

Ø
168

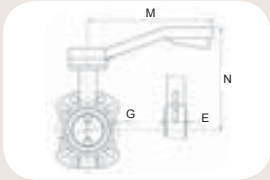

Transair	ØD (in)	DN	G	M	N	E
VR02 L8 00	6	150	240	300	290	56

Model has CE marking. Supplied with eight M20 bolts kit (bolt length: 140mm) Nitrile seal.

Ø
40

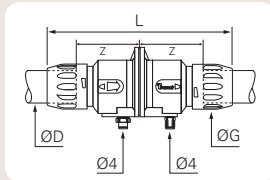

Remote control shut-off valve

Transair	ØD	G	L	Z
4230 00 40	40	67	261	85.0

Min. working pressure: 58 psi • Max. working pressure: 235 psi
The Transair remote control shut-off valve is supplied with a plugged vent hole. This allows venting of the downstream network, after closing the valve.

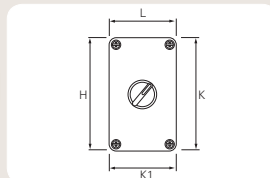
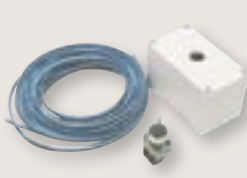



Pilot kit

Transair	H	K	K1	L
4299 03 01	145	106	70	82





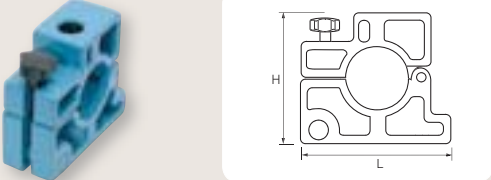

This pilot kit includes: pneumatic ON/OFF switch (maximum 235 psi operating pressure), twin 4 mm OD polyurethane tube (length 10 m) and plastic box.

> Tools

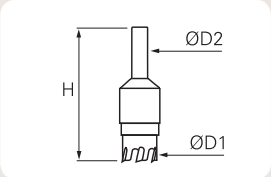
- > Practical tools for the installation and extension of Transair air pipe systems.
- > Presented in a carrying case or available as separate parts.

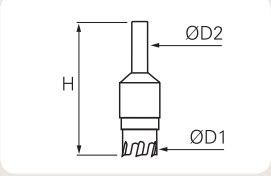
<p>Ø 16.5 to 63</p>		<p>Tool case</p> <table border="1"> <thead> <tr> <th>Transair</th> <th>H</th> <th>L</th> <th>I</th> </tr> </thead> <tbody> <tr> <td>6698 00 03</td> <td>315</td> <td>290</td> <td>105</td> </tr> </tbody> </table> <p>This tool case simplifies the use and transportation of tools. It contains all the tools necessary for completing an installation:</p> <ul style="list-style-type: none"> - Drilling jigs 6698 01 01 and 6698 01 02 - Drilling tools 6698 02 01 and 6698 02 02 - Cutter for rigid pipe 6698 03 01 - Chamfer tool 6698 04 01 - Deburring tool 6698 04 02 - Set of tightening spanners 6698 05 03 - Marking tool 6698 04 03 	Transair	H	L	I	6698 00 03	315	290	105								
Transair	H	L	I															
6698 00 03	315	290	105															
<p>Ø 16.5 to 168</p>		<p>Pipe cutter</p> <table border="1"> <thead> <tr> <th>Transair</th> <th>L</th> <th>H</th> <th>Used for Transair pipe</th> </tr> </thead> <tbody> <tr> <td>6698 03 01</td> <td>230</td> <td>98</td> <td>Ø 16.5 - 25 - 40 - 63</td> </tr> <tr> <td>EW08 00 01</td> <td>360</td> <td>155</td> <td>Ø 63 - 76 - 100</td> </tr> <tr> <td>EW08 00 03</td> <td>600</td> <td>300</td> <td>Ø 100 - 168</td> </tr> </tbody> </table>	Transair	L	H	Used for Transair pipe	6698 03 01	230	98	Ø 16.5 - 25 - 40 - 63	EW08 00 01	360	155	Ø 63 - 76 - 100	EW08 00 03	600	300	Ø 100 - 168
Transair	L	H	Used for Transair pipe															
6698 03 01	230	98	Ø 16.5 - 25 - 40 - 63															
EW08 00 01	360	155	Ø 63 - 76 - 100															
EW08 00 03	600	300	Ø 100 - 168															
<p>Ø 25 to 40</p>		<p>Drilling jig for rigid aluminum pipe</p> <table border="1"> <thead> <tr> <th>Transair</th> <th>H</th> <th>L</th> </tr> </thead> <tbody> <tr> <td>6698 01 01</td> <td>120</td> <td>80</td> </tr> </tbody> </table> <p>After drilling, deburr and clean the pipe.</p>	Transair	H	L	6698 01 01	120	80										
Transair	H	L																
6698 01 01	120	80																
<p>Ø 63</p>		<p>Drilling jig for rigid aluminum pipe</p> <table border="1"> <thead> <tr> <th>Transair</th> <th>H</th> <th>L</th> </tr> </thead> <tbody> <tr> <td>6698 01 02</td> <td>134</td> <td>155</td> </tr> </tbody> </table> <p>After drilling, deburr and clean the pipe.</p>	Transair	H	L	6698 01 02	134	155										
Transair	H	L																
6698 01 02	134	155																

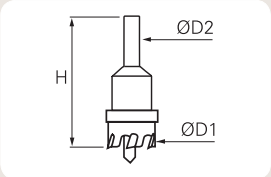
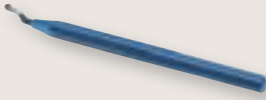
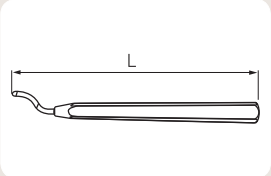
> Tools

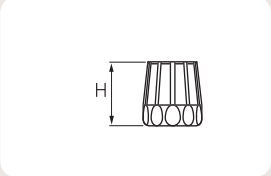
<p>Ø 25</p>		
<p>Ø 40 63</p>		
<p>Ø 40 to 168</p>		
<p>Ø 16.5 to 168</p>		
<p>Ø 16.5 25 40</p>		

Drilling tool for aluminum pipe

Transair	ØD1	ØD2	H	For Transair pipe
6698 02 02	16	12	71	Ø 25mm

Drilling tool 6698 02 02 is required to install Ø 25 Transair brackets.
Can be used with all types of drills.

Transair	ØD1	ØD2	H	For Transair pipe
6698 02 01	22	12	71	Ø 40 - 63mm

Drilling tool 6698 02 01 is required to install Ø 40 and Ø 63 Transair brackets. It is also used to create the two holes needed for double-clamp ring connectors when cutting to length Ø 63 Transair pipe.

Transair	ØD1	ØD2	H	For Transair pipe
EW09 00 22	22	12	71	Ø 40 - 63mm
EW09 00 30	30	12	71	Ø 76 - 100mm
EW09 00 51	51	12	110	Ø 168mm
EW09 00 64	64	12	110	Ø 168mm

Drilling tool EW09 is required to install Transair simple reducing brackets.
After drilling, it is important to deburr and clean the pipe.

Deburring tool for aluminum pipe

Transair	L
6698 04 02	140

Chamfer tool for aluminum pipe

Transair	H
6698 04 01	64

For 16.5, 25 and 40mm.

Ø
16.5
25
40

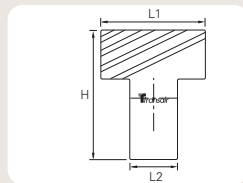

Marking tool for aluminum pipe

Transair	H	L1	L2
6698 04 03	88	73	33

The marking tool is used as a guide for marking cut lengths on Transair pipe. These marks indicate the insertion limits of the pipe into each fitting in order to ensure a good airtight connection and secure grip.

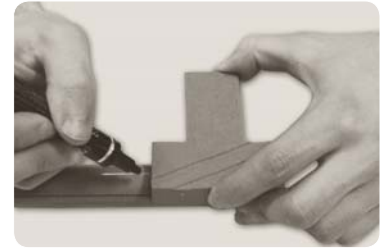

Ø
63



Spanner wrenches for Ø 63mm fittings

Transair
6698 05 03

Includes two tightening spanners.

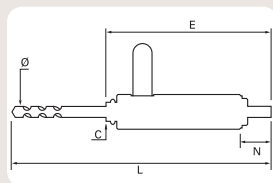

Pressurised system drilling tool

Transair	C	ØD	L	E	N
EA98 06 00	1/2"	13	330.0	154.0	30.5

> Tools



Portable tool kit

Transair	V
EW01 00 02	14

This case contains: one portable tool, one 14V battery and battery charger.

Ø
76
100
168

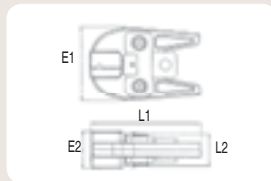

Jaws for portable tool

Transair	ØD	E1	E2	L1	L2
EW02 L1 00	76	103	52	154	46
EW02 L3 00	100	103	71	154	46
EW02 L8 00	168	103	71	154	46







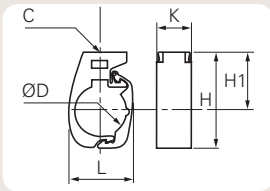

14V battery for portable tool

Transair	V
EW03 00 01	14

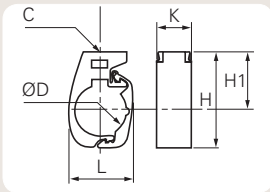
> Fixture accessories

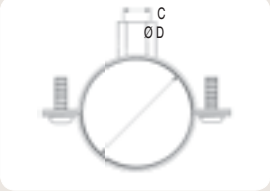
- > Easy adaptation for all pipework configurations
- > For suspension of pipes, from walls, partitions, beams, cable trays, Canalis electrical installations, etc, vertically or horizontally
- > Perfectly suited for use with Transair systems
- > Non-flammable (conforms to UL94V-2 standard)

<p>Ø 16.5 25 40</p>		
<p>Ø 63</p>		
<p>Ø 76 100 168</p>		
<p>Ø 76 100</p>		

Fixing clip for rigid pipe

Transair	ØD	C	H1	H	K	L
6697 17 01	16.5	1/4"	46	61	30	32.5
6697 25 01	25	1/4"	46	65.5	30	38.5
6697 40 01	40	1/4"	46	74.5	30	50

Transair fixing clips are designed to bear a maximum weight of 44lbs.

However, to ensure good stability of the system, we recommend the use of at least two clips per pipe i.e.:

- maximum 5 ft space between clips for 10 ft lengths of pipe
- maximum 10 ft space between clips for 20 ft lengths of pipe

Use only this clip for fixing Transair rigid pipe, all other type of pipe clips are to be avoided. Fix the clip to a rigid support (U-channel, cable tray) to allow for expansion while retaining the pipe.

Transair	ØD	C	H1	H	K	L
6697 63 01	63	3/8"	90	127.5	30	73.5

Transair fixing clips are designed to bear a maximum weight of 44lbs.

However, to ensure good stability of the system, we recommend the use of at least two clips per pipe i.e.:

- maximum 5 ft space between clips for 10 ft lengths of pipe
- maximum 10 ft space between clips for 20 ft lengths of pipe

Use only this clip for fixing Transair rigid pipe, all other type of pipe clips are to be avoided. Fix the clip to a rigid support (U-channel, cable tray) to allow for expansion while retaining the pipe.

Transair	ØD	C
ER01 L1 00	76	3/8"
ER01 L3 00	100	3/8"
ER01 L8 00	168	3/8"

Transair fixing clips are designed to bear a maximum weight of 44lbs.

However, to ensure good stability of the system, we recommend the use of at least two clips per pipe i.e.:

- maximum 5 ft space between clips for 10 ft lengths of pipe
- maximum 10 ft space between clips for 20 ft lengths of pipe

Use only this clip for fixing Transair rigid pipe, all other type of pipe clips are to be avoided. Fix the clip to a rigid support (U-channel, cable tray) to allow for expansion while retaining the pipe.

Transair	ØD	C
EX01 L1 00	76	3/8"
EX01 L3 00	100	3/8"

Transair fixing clips are designed to bear a maximum weight of 44lbs.

However, to ensure good stability of the system, we recommend the use of at least two clips per pipe i.e.:

- maximum 5 ft space between clips for 10 ft lengths of pipe
- maximum 10 ft space between clips for 20 ft lengths of pipe

Use only this clip for fixing Transair rigid pipe, all other type of pipe clips are to be avoided. Fix the clip to a rigid support (U-channel, cable tray) to allow for expansion while retaining the pipe.

> Fixture accessories

Ø
16.5
to
63

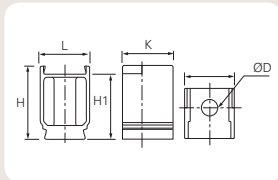

Spacer

Transair	ØD	H	H1	K	L
6697 00 03	11	49.5	44	34	33

This spacer, in association with a Transair pipe clip, allows consistent alignment of pipes when different diameters of pipe are run concurrently in the same line.

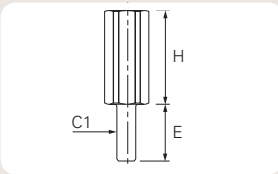

Threaded rod adaptor

Transair	C1	E	H
0169 00 05 00	1/4"	16	30

The use of this adaptor facilitates the suspension of Transair 16.5, 25 or 40mm with 3/8" threaded rod.

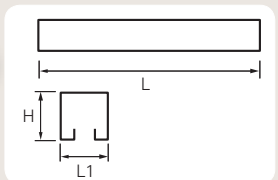
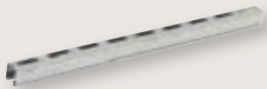

U-channel

Transair	H	L(ft)	L1
6699 01 01	25	6'6"	25

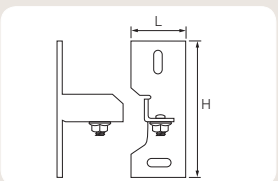
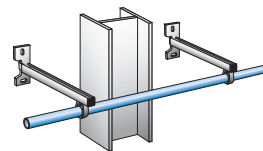

U-channel fixing bracket

Transair	H	L
6699 01 02	106	40

This set includes:

- 1 bracket
- 1 fixing bolt & nut
- 1 nut
- 1 rail profile end cap

> Hose reels

Hose reels

- > Optimize productivity and the safety of your work area
- > Prevent hose damage occurring on the workshop floor
- > Maximum working pressure, dependant on the model:
 - 6698 11 11: 250 psi
 - 6698 11 12: 250 psi
- > Working temperature: -4°F to +14°F

25 ft

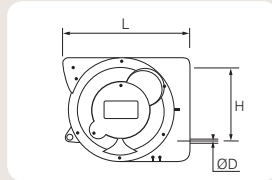

Light series hose reel

Transair	Hose i.d. (in)	Max. Pressure (psi)	H	L
6698 11 11	3/8	250	251	300

Hose clutch with free return
Outlet connection 1/4 male - 3/8" inlet

50 ft

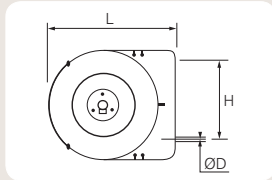

Light series hose reel

Transair	Hose i.d. (in)	Max. Pressure (psi)	H	L
6698 11 12	3/8	250	251	390







Hose clutch with free return
Outlet connection 1/4 male - 3/8" inlet



> Composite automatic safety couplers

- > For quick and repetitive connection and disconnection
- > 100% safety – ISO 4414 and European EN 983 compliant
- > Very high flow, extremely low pressure loss
- > Lightweight and robust
- > Improved hand grip
- > Fast vent time

- > Male thread with integral seal
- > Suitable fluids: compressed air, argon, nitrogen (please consult us for other fluids)
- > Max. working pressure: 232 psi
- > Working temperature: from -4°F to +140°F

		Male NPT		Female NPT		Coupler with hosetail
ISO B 1/4" Safety		Transair C CP05 U1N02 1/4" CP05 U1N03 3/8" CP05 U1N04 1/2"		Transair C CP15 U1N02 1/4" CP15 U1N03 3/8" CP15 U1N04 1/2"		Transair ØD (mm) CP21 U1 06 6 CP21 U1 08 8 CP21 U1 10 10
		Male NPT		Female NPT		Coupler with hosetail
		Transair C CP05 U2N02 1/4" CP05 U2N03 3/8" CP05 U2N04 1/2"		Transair C CP15 U2N02 1/4" CP15 U2N03 3/8" CP15 U2N04 1/2"		Transair ØD (mm) CP21 U2 08 8 CP21 U2 10 10 CP21 U2 13 13
ARO 1/4" Safety		Male NPT		Female NPT		Coupler with hosetail
		Transair C CP05 A1N02 1/4" CP05 A1N03 3/8" CP05 A1N04 1/2"		Transair C CP15 A1N02 1/4" CP15 A1N03 3/8" CP15 A1N04 1/2"		Transair ØD (mm) CP21 A1 06 6 CP21 A1 08 8 CP21 A1 10 10

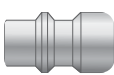

ISO B 1/4"
 ISO 6150 B
 AFNOR NF 49-053
 US.MIL.C4109
 CEJN 310
 RECTUS 23-24

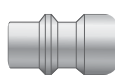

ISO B 3/8"
 ISO 6150 B
 AFNOR NF 49-053
 US.MIL.C4109
 CEJN 430
 RECTUS 30

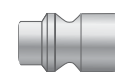

ARO 1/4"
 ARO 210
 CEJN 300
 ORION 44510
 PARKER 50
 RECTUS 14-22

Flow curve – pressure loss

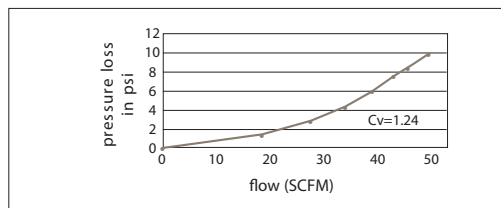

Transair composite automatic couplers comply with worldwide ISO 4414 and European EN 983 safety standards. Disconnection is by a double twist of the sleeve.

1st rotation in direction of the arrow: pressure rapidly vented out, plug side.



2nd rotation in direction of the arrow: safe disconnection of body and plug.

ISO B	Male plug NPT	Female plug NPT	Plug with hosetail																				
1/4"	<p>Male plug NPT</p> <table border="1"> <tr> <th>Transair</th> <th>C</th> </tr> <tr> <td>9084 23 14</td> <td>1/4"</td> </tr> <tr> <td>9084 23 18</td> <td>3/8"</td> </tr> </table>	Transair	C	9084 23 14	1/4"	9084 23 18	3/8"	<p>Female plug NPT</p> <table border="1"> <tr> <th>Transair</th> <th>C</th> </tr> <tr> <td>9083 23 14</td> <td>1/4"</td> </tr> <tr> <td>9083 23 18</td> <td>3/8"</td> </tr> </table>	Transair	C	9083 23 14	1/4"	9083 23 18	3/8"	<p>Plug with hosetail</p> <table border="1"> <tr> <th>Transair</th> <th>ØD (mm)</th> </tr> <tr> <td>9085 23 56</td> <td>6</td> </tr> <tr> <td>9085 23 08</td> <td>8</td> </tr> <tr> <td>9085 23 60</td> <td>10</td> </tr> </table>	Transair	ØD (mm)	9085 23 56	6	9085 23 08	8	9085 23 60	10
Transair	C																						
9084 23 14	1/4"																						
9084 23 18	3/8"																						
Transair	C																						
9083 23 14	1/4"																						
9083 23 18	3/8"																						
Transair	ØD (mm)																						
9085 23 56	6																						
9085 23 08	8																						
9085 23 60	10																						
3/8"	<p>Male plug NPT</p> <table border="1"> <tr> <th>Transair</th> <th>C</th> </tr> <tr> <td>9084 30 14</td> <td>1/4"</td> </tr> <tr> <td>9084 30 18</td> <td>3/8"</td> </tr> </table>	Transair	C	9084 30 14	1/4"	9084 30 18	3/8"	<p>Female plug NPT</p> <table border="1"> <tr> <th>Transair</th> <th>C</th> </tr> <tr> <td>9083 30 14</td> <td>1/4"</td> </tr> <tr> <td>9083 30 18</td> <td>3/8"</td> </tr> </table>	Transair	C	9083 30 14	1/4"	9083 30 18	3/8"	<p>Plug with hosetail</p> <table border="1"> <tr> <th>Transair</th> <th>ØD (mm)</th> </tr> <tr> <td>9085 30 08</td> <td>8</td> </tr> <tr> <td>9085 30 60</td> <td>10</td> </tr> <tr> <td>9085 30 62</td> <td>13</td> </tr> </table>	Transair	ØD (mm)	9085 30 08	8	9085 30 60	10	9085 30 62	13
Transair	C																						
9084 30 14	1/4"																						
9084 30 18	3/8"																						
Transair	C																						
9083 30 14	1/4"																						
9083 30 18	3/8"																						
Transair	ØD (mm)																						
9085 30 08	8																						
9085 30 60	10																						
9085 30 62	13																						
ARO 1/4"	<p>Male plug NPT</p> <table border="1"> <tr> <th>Transair</th> <th>C</th> </tr> <tr> <td>9084 22 14</td> <td>1/4"</td> </tr> <tr> <td>9084 22 18</td> <td>3/8"</td> </tr> </table>	Transair	C	9084 22 14	1/4"	9084 22 18	3/8"	<p>Female plug NPT</p> <table border="1"> <tr> <th>Transair</th> <th>C</th> </tr> <tr> <td>9083 22 14</td> <td>1/4"</td> </tr> <tr> <td>9083 22 18</td> <td>3/8"</td> </tr> </table>	Transair	C	9083 22 14	1/4"	9083 22 18	3/8"									
Transair	C																						
9084 22 14	1/4"																						
9084 22 18	3/8"																						
Transair	C																						
9083 22 14	1/4"																						
9083 22 18	3/8"																						

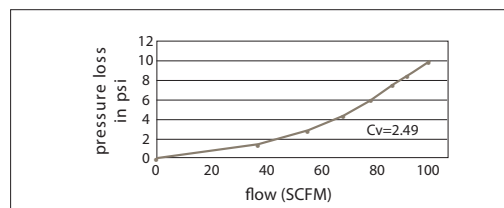

> Notes



A series of horizontal dotted lines for taking notes, spanning the width of the page below the image.

> Installation guide



Essential instructions		
Installation instructions		45
Sound engineering practice for the optimization of an air pipe system		46
Aluminum pipe		
General		44
Aluminum pipe section		49
Pipe-to-pipe connectors		
General		53
Connection / disconnection		55
Practical examples		58
Do's / don'ts		62
Quick assembly brackets		
General		64
Installing a quick assembly bracket		65
Practical examples		68
Flexible hose		
General		70
System connection		71
Do's / don'ts		74
Fixture accessories		
Attachments		72
Supporting a Transair system		77
Practical information		
Z dimensions		79
Expansion / contraction		80
Conversion charts		84
Transair in use		86
Index		88
Offer of sale		90

> Installation

> Installation instructions

> General

Prior to the installation of a Transair compressed air distribution system, the installer should ensure that the installation area complies with any regulations applicable to areas exposed to explosive hazards (in particular the effect of static electricity in a silo area). Transair should be installed downstream of the compressed air receiver, or after the dryer. Flexible Transair hose can be installed at the start of the system in order to eliminate any sources of vibration and to facilitate maintenance operations. When maintaining or modifying a Transair system, the relevant section should be vented prior to the commencement of any work. Installers should use only Transair components and accessories, in particular Transair pipe clips and fixture clamps. The technical properties of the Transair components, as described in the Transair catalog, must be respected.

> Pressurizing the system

Once the Transair installation has been installed and prior to pressurizing, the installer should complete all tests, inspections and compliance checks as stated in any contract and according to sound engineering practice and current local regulations.

> Transair pipe and hoses

Transair pipe should be protected from mechanical impact, particularly if exposed to collision with fork-lift trucks or when sited in an environment with moving overhead loads. Similarly, rotation of the pipe and pipe supports should be avoided. Transair pipe must not be welded. Flexible Transair hoses should be used in accordance with the recommendations of the installation guidelines.

Note: In certain situations, Transair aluminum pipe may be formed with a bend - please contact us for further information.

> Expansion / contraction

Expansion and contraction of the system should be calculated prior to installation. The system designer and installer should calculate the elongation or retraction of each Transair line according to the recommendations in this installation guide.

> Component assembly

Transair components are provided with assembly instructions for their correct use - simply follow the methods and recommendations stated in this document.

> Transair installations - situations to avoid

- > installation within a solid mass (concrete, foam, etc.)
- > the hanging of any external equipment to Transair pipe
- > the use of Transair for grounding, or as a support for electrical equipment
- > exposure to chemicals that are incompatible with Transair components (please contact us for further details)

> Sound engineering practice for the optimization of an air pipe system

> When installing a Transair system, the work should be performed in accordance with good engineering practice.

> Bends and bypasses represent sources of pressure drop. To avoid excessive pressure loss, use modular consoles to offset the network and to bypass obstacles. Keep in-line pipe diameter reductions to a minimum.

> Maintain a consistent level of good quality air by use of adequate filtration at the compressor outlet.

> The diameter of the pipe will influence pressure drop and the operation of point-of-use equipment. Select the diameter according to the required flow rate and acceptable pressure drop at the point of use.

> Position drops should be as close as possible to the point of use.

> Transair aluminum pipe

> General



Ø 16.5

Deburred and chamfered pipe

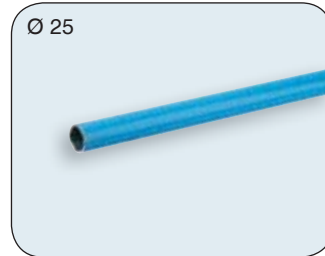

Ø 25

Deburred and chamfered pipe

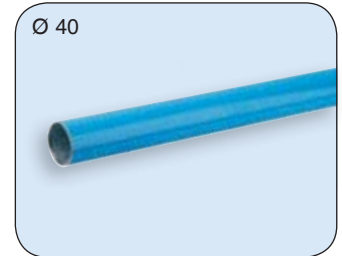

Ø 40

Deburred and chamfered pipe



Ø 63

Pipe pre-drilled at each end with two 22mm diameter holes, deburred and chamfered



Ø 76

Pipe lugged at each end, deburred and chamfered



Ø 100 and Ø 168

Pipe lugged at each end, deburred and chamfered

> Presentation

Transair aluminum pipe is supplied ready for use. No particular preparation (cutting, deburring, chamfering, etc.) is required.

Thanks to the rigidity of Transair aluminum pipe, temperature-related expansion / contraction is reduced to a minimum. The Transair system retains its straightness, and hence its performance, over time (reduction of pressure drop caused by surface friction).

Transair aluminum pipe is calibrated and fits perfectly with all Transair components. Each connection is automatically secured and the seal is optimized, which minimizes corrosion to the internal surface.

Transair aluminum pipe has a protective powder coating (Qualicoat certified) and is thus protected from external corrosion. Its color allows the system to be immediately identified and gives a clean and aesthetic overall appearance.

Standard colors available:

- blue (RAL 5012/BS1710)
 - grey (RAL 7001)
 - green (RAL 6029)
- (please contact us for other colors)

Transair aluminum pipe is available in seven diameters in 1/2" thru 6".

> Applications

Transair Ø 16.5 - Ø 25 - Ø 40 - Ø 63 - Ø 76 - Ø 100 - Ø 168 aluminum pipe has been specially designed for compressed air, vacuum and inert gases (argon, nitrogen) - please contact us for other fluids.

> Marking

Pipe calibration is a guarantee of secure connection and sealing

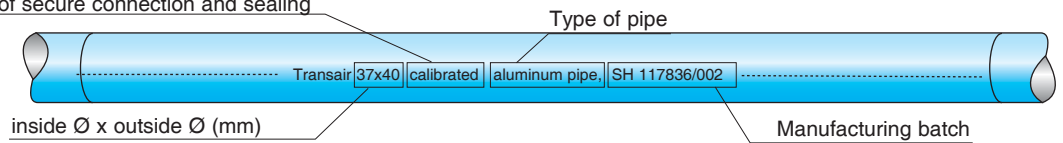

The transported fluid can be instantly identified by the color of the pipe

- ex: Blue pipe → compressed air system
- ex: Grey pipe → vacuum system
- ex: Green pipe → inert gas system

> Connection indicator

Only on Ø 16.5 - Ø 25 - Ø 40 aluminum pipe

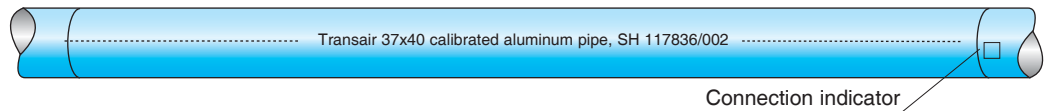

> Drilling locator: mark lines for correct drilling

Only on Ø 16.5 - Ø 25 - Ø 40 - Ø 63 aluminum pipe

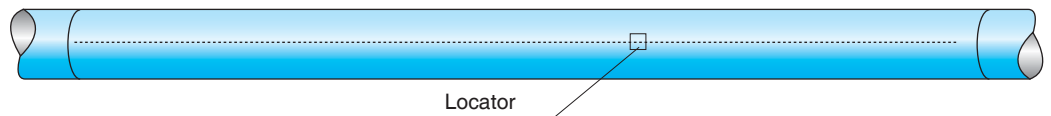

Drilling locators are used to correctly position Transair brackets onto the pipe. There are two locators on each pipe. The second locator is used to position a second bracket perpendicular to a first bracket.

> Transair aluminum pipe

> Aluminum pipe section

> Ø 16.5 - Ø 40

> Tools

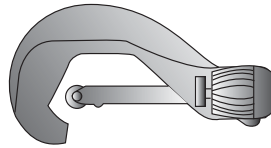

Pipe cutter for aluminum pipe
ref. 6698 03 01



Chamfer tool for aluminum pipe
ref. 6698 04 01



Deburring tool for aluminum pipe
ref. 6698 04 02



Marking tool for aluminum pipe
ref. 6698 04 03

> Procedure

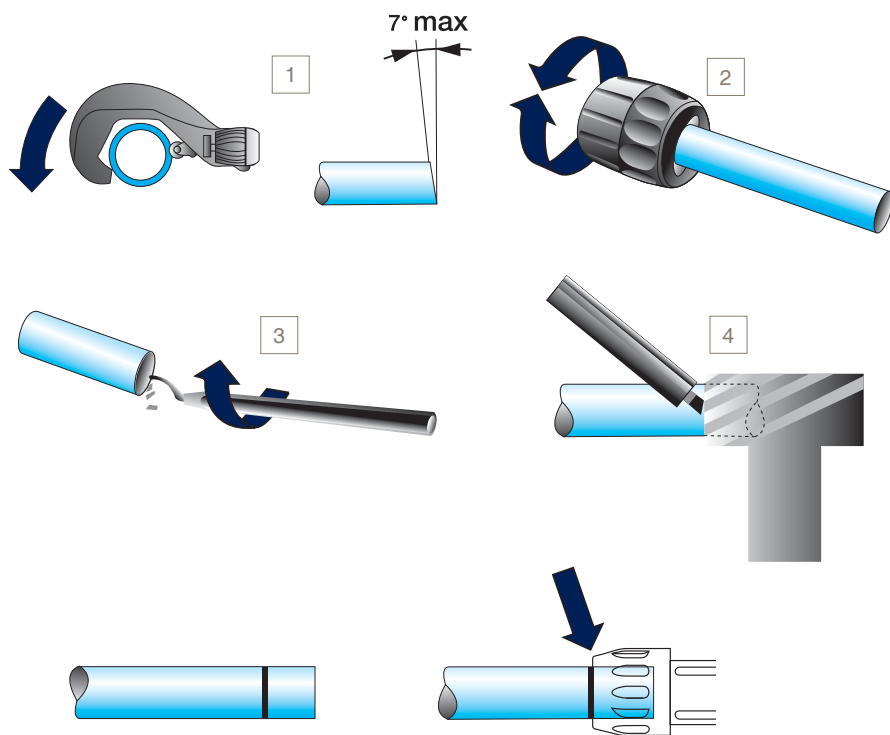

- 1 - Cutting the pipe:
- place the pipe in the pipe cutter
 - position the blade onto the pipe
 - rotate the pipe cutter around the pipe while gently tightening the wheel

- 2 - Carefully chamfer the outer edges
- 3 - Deburr the inner end of the pipe
- 4 - Trace the connection indicator using the marking tool

The insertion lengths for Ø 16.5 - Ø 25 - Ø 40 connectors are 25 mm, 27 mm and 45 mm respectively, with the exception of the end cap (6625), for which the insertion lengths are of 39 mm, 42 mm and 64 mm respectively.

> Ø 63

> Tools

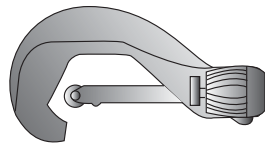

Pipe cutter for aluminum pipe
ref. 6698 03 01



Chamfer
ref. 6698 04 01



Deburring tool for aluminum pipe
ref. 6698 04 02

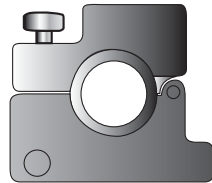

Drilling jig for aluminum pipe
ref. 6698 01 02



Drilling tool for aluminum pipe
ref. 6698 02 01

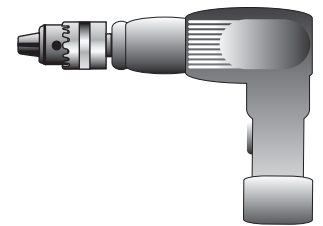

Drill

> Procedure

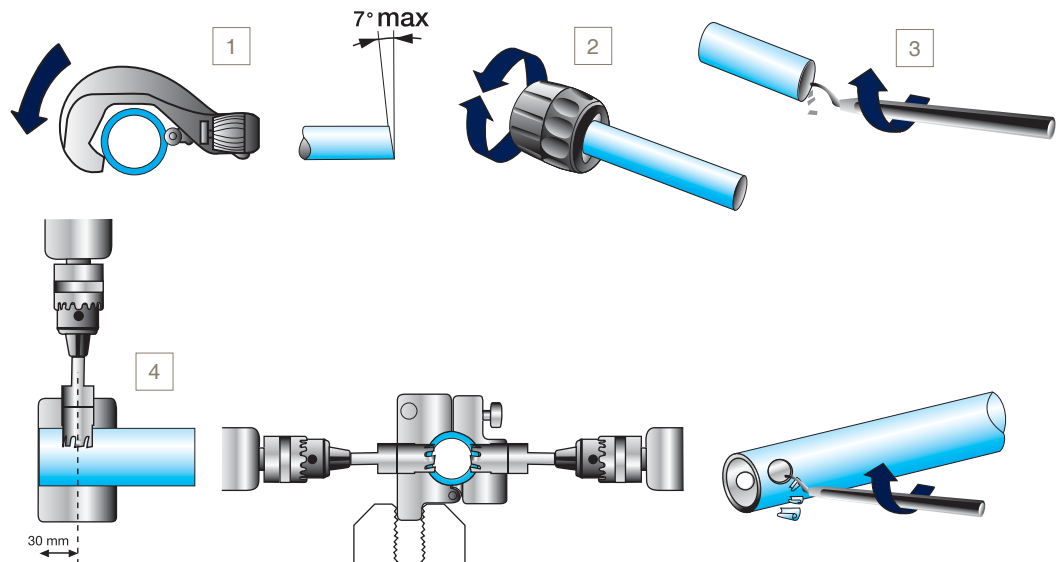

1 - Cutting the pipe:

- place the pipe in the pipe cutter
- position the blade on the pipe
- rotate the pipe cutter around the pipe while gently tightening the wheel

2 - Carefully chamfer the outer edges

3 - Deburr the inner end of the pipe

- 4 - Drill the two clamp holes using the drilling jig (6698 01 02) and the Ø 22 mm drilling tool (6698 02 01). Loosen the jig, release the pipe, then deburr both holes. Ensure that all outer and inner surfaces are smooth and clear of burrs and potential sharp edges.

> Transair aluminum pipe

> Aluminum pipe section

> Ø 76 - Ø 168

> Tools

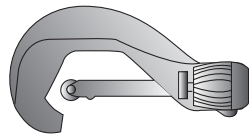

Pipe cutter for aluminum pipe ref. EW08 00 01 (Ø 76 - Ø 100) or EW08 00 03 (Ø 168)



Deburring tool ref. 6698 04 02



Portable tool kit ref. EW01 00 02



Pipe forming jaw set ref. EW02 L1 00 (Ø 76) or EW02 L3 00 (Ø 100) or EW02 L8 00 (Ø 168)

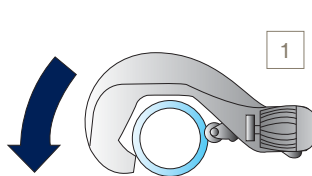

- 1 - Cutting the pipe:
- place the pipe in the pipe cutter
 - position the blade on the pipe
 - rotate the pipe cutter around the pipe while gently tightening the wheel

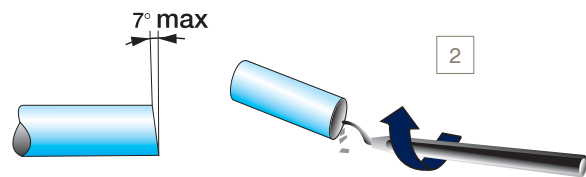

- 2 - Carefully deburr the outer and inner edges of the pipe

3

> Procedure



Open the retaining pin at the front of the machine by pressing the jaw release button



Place the jaws in the housing



Lock in position by closing the retaining pin

- 3 - Creating the lugs for Ø 76, Ø 100 or Ø 168 cut pipe

> Procedure

4

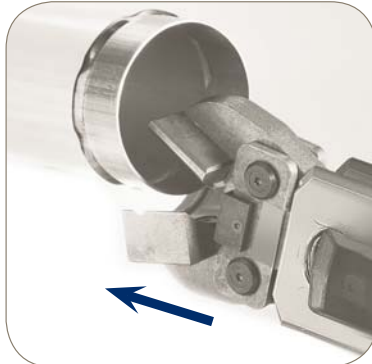

Manually open the jaws of the clamp and insert the aluminum pipe into the clamp as far as it will go

>

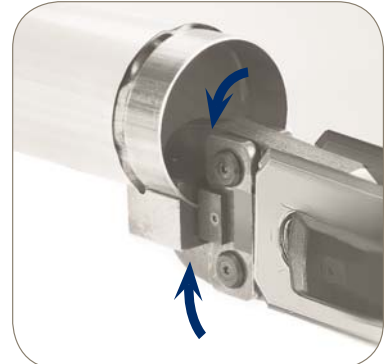

Release the jaws. Press the trigger and crimp the tube until a 'snap' sound is heard



Re-open the two jaws to remove the pipe and rotate the pipe slightly

>



Renew the operation until the required minimum number of lugs for each diameter is achieved

	Ø 76	Ø 100	Ø 168
Min. number of lugs	5	6	10

Important: Do not overlap the lugs!

> Transair connectors

> General

> Ø 16.5
Ø 25
Ø 40

Instant connection by means of a gripping ring

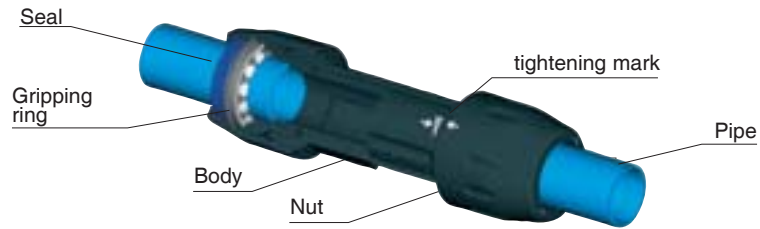

The Ø 16.5 - Ø 25 - Ø 40 connectors instantly connect to Transair aluminum pipe. Simply insert the pipe into the connector up to the connector insertion mark. The internal gripping ring is then automatically secured and the connection is complete.

> Ø 63

Double clamp quick-fit connection



The Ø 63 connectors are quickly secured to Transair aluminum pipe by means of a double clamp, which makes the connector fully integrated with the pipe. Connection is achieved by simply tightening the nut.

> Ø 76
Ø 100
Ø 168

Clamp quick-fit connection

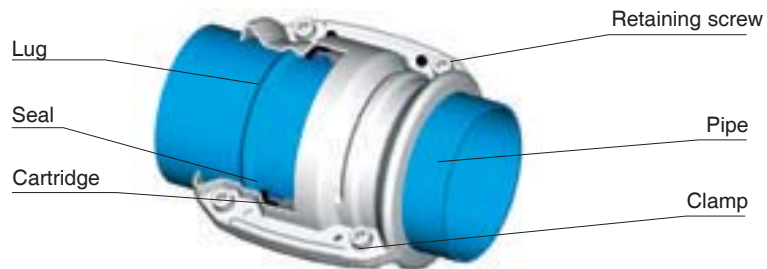

The Ø 76 - Ø 100 - Ø 168 clamps secure instantly to Transair aluminum pipe. Simply position the formed pipe within the Transair cartridge, which acts as a seal. Close the Transair clamp to secure the connection and finally tighten the four retaining screws.

> Pre-assembled tightening indicators for Ø 16.5, Ø 25 and Ø 40 connectors

There are important visual markings on the bodies and nuts of Transair Ø 16.5, Ø 25 and Ø 40 connectors. These are represented by solid and empty arrows and indicate the optimum torque. When assembling Transair connectors, the nuts are tightened to a pre-defined torque on the body of the connector. This torque guarantees the seal and safety of each connection.

There is no need to loosen the nuts prior to joining Ø 16.5, Ø 25 and Ø 40 connectors to Transair aluminum pipe.

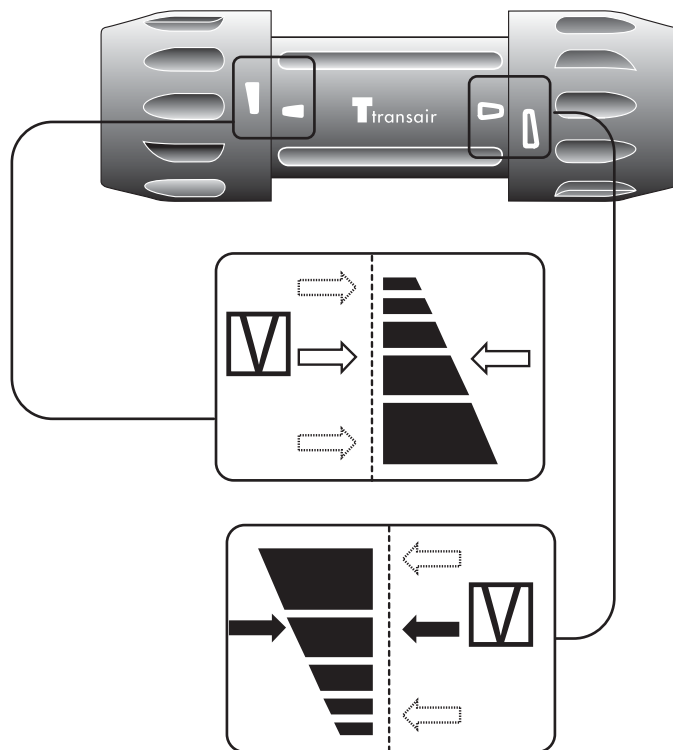

Before using Ø 16.5, Ø 25 or Ø 40 connectors, ensure that the arrow marks are correctly aligned with each other.

> Transair connectors

> Connection / disconnection

Connection

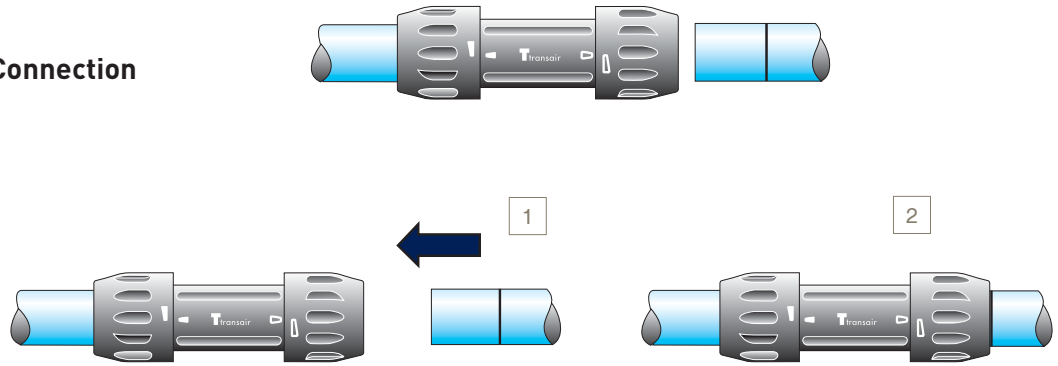

Disconnection

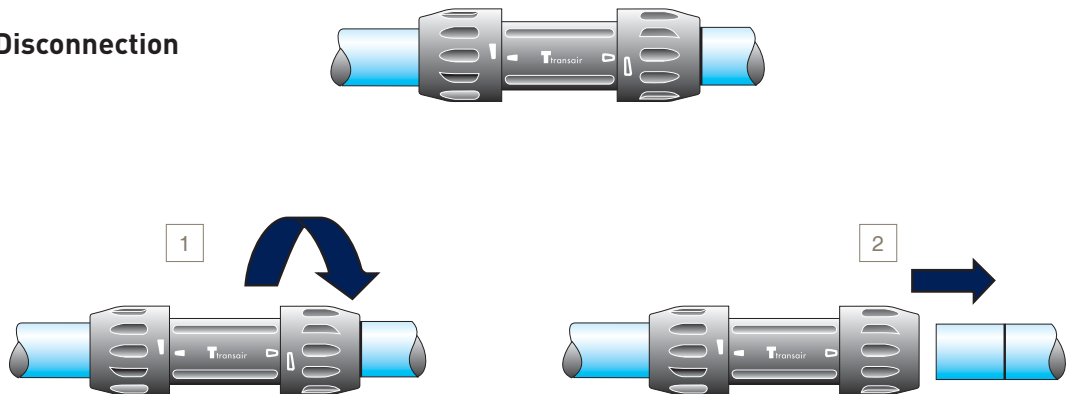

> Ø 16.5
Ø 25
Ø 40

Simply insert the pipe into the connector up to the connection mark. To disconnect, unscrew the nut by one half turn and remove the pipe.

Lateral dismantling: see page 60 of this catalog.

> Note – when using end caps (ref. 6625)

The insertion length is greater for end caps than for other Transair connectors. The connection mark should be applied to the pipe by means of a marker and tape measure, using the following values:

- Ø 16.5: 1.5 in.
- Ø 25: 1.7 in.
- Ø 40: 2.5 in.

> Ø 63

Connection

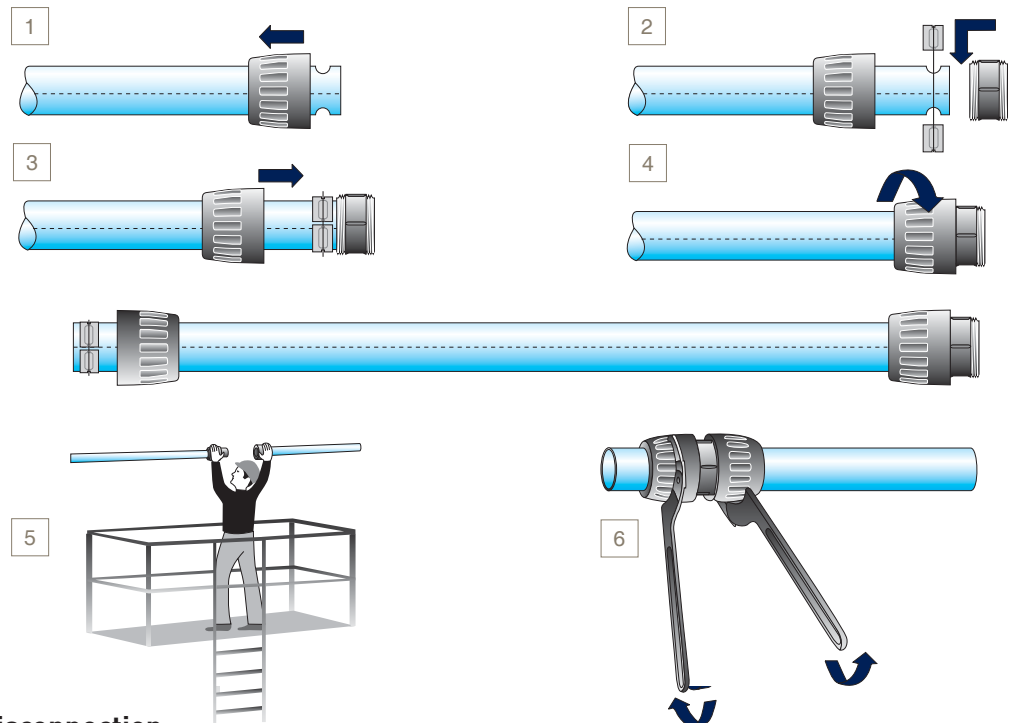

Disconnection

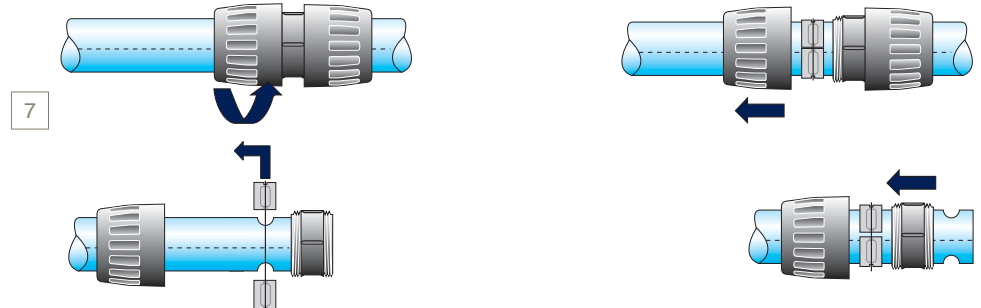

- 1 - Unscrew one of the connector nuts and fit over the pipe
- 2 - Position the double clamp ring in the appropriate housings (two holes at the end of the pipe)
- 3 - Bring the nut towards the body, which was previously positioned at the end of the pipe, until it stops against the double clamp

- 4 - Tighten the nut by hand
- 5 - Bring the two pipes together
- 6 - Complete the assembly by 1/2 rotation with Transair tightening spanners ref. 6698 05 03
- 7 - To disconnect, perform the same operations in reverse order

Lateral dismantling: see page 60 of this catalog.

> Transair connectors

> Connection / disconnection

> Ø 76
 Ø 100
 Ø 168

Connection

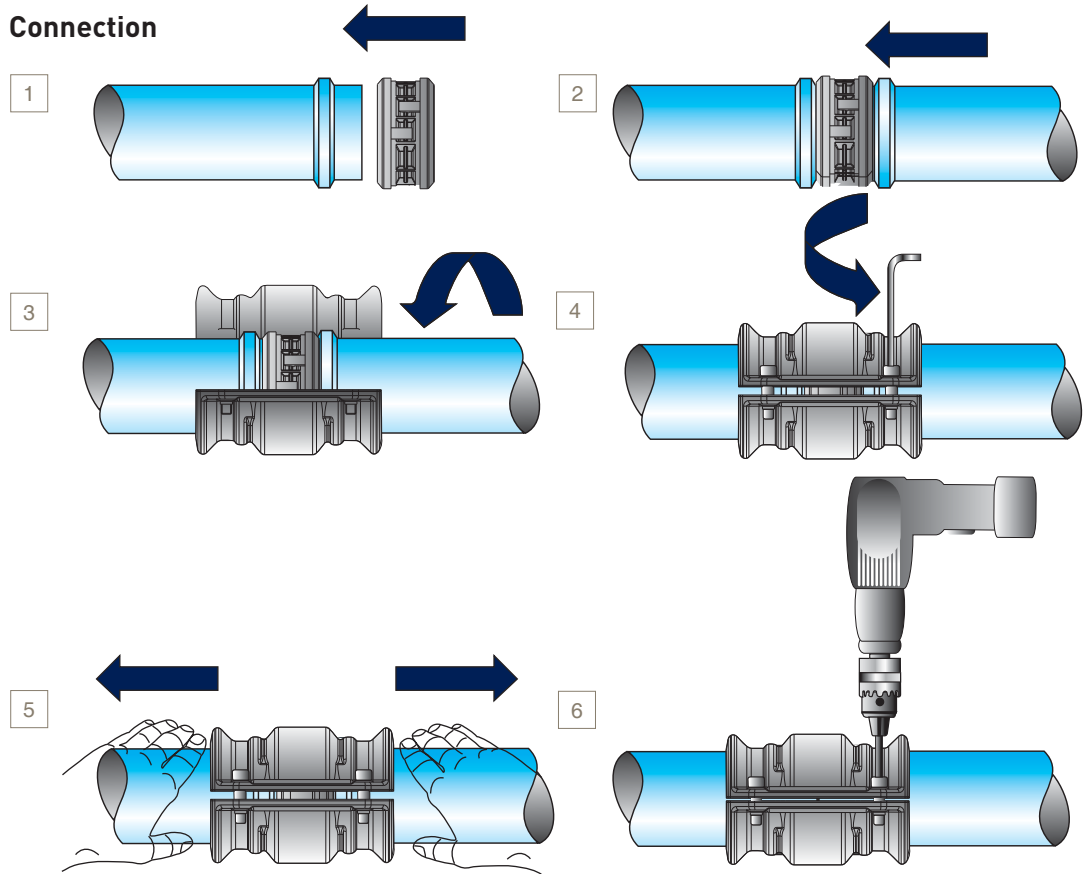

- 1 - Slip the cartridge over the end of the first pipe fully up to the shoulder
- 2 - Bring the second pipe to the cartridge and slide fully up to the shoulder
- 3 - Position the clamp over the cartridge / pipe assembly

- 4 - Hand tighten the pre-fitted screws with an Allen key
- 5 - Pull the pipes fully back towards the outside of the clamp
- 6 - Fully tighten the clamp screws (maximum tightening torque: final closure of clamps)

For effective clamp sealing, screw tightening should be performed on alternate sides of the clamp as shown below:

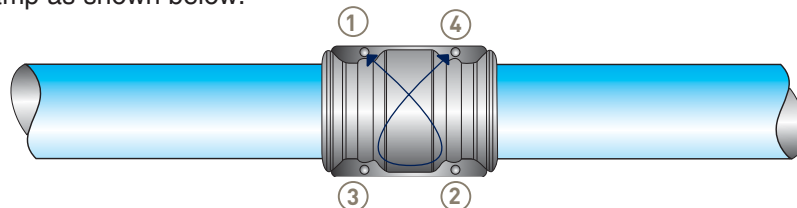

To disconnect, perform the same operations in reverse order.

> Practical examples

> Various Ø 76 and Ø 100 configurations

<p>> Changing direction with a 90° elbow</p>	<p>1 x RX02 2 x RR01</p>
<p>> Changing direction with a tee</p>	<p>1 x RX04 3 x RR01</p>
<p>> Connecting an end cap</p>	<p>1 x RX25 1 x RR01</p>
<p>> Connecting a circular flange and a connector</p>	<p>1 x EW05 1 x EW06 1 x RX30 1 x RR01</p>
<p>> Reduction from Ø 100 to Ø 76</p>	<p>Ø 100 Ø 76 1 x RR01 L3 00 1 x RX66 L3 L1 1 x RR01 L1 00</p>
<p>> Connecting a butterfly valve</p>	<p>1 x RR01 1 x RX30 1 x VR02 1 x RX30 1 x RR01</p>
<p>> Connecting a flexible hose and a circular flange</p>	<p>1 x EW05 1 x RX30 1 x RR01 1 x FP01</p>
<p> RX 24 L1 40 RX 24 L3 40 6625 40 00 RX 24 L1 40 RX 24 L3 40 4002 40 00 RX 24 L1 63 RX 24 L3 63 6625 63 00 </p>	

> Transair connectors

> Practical examples

> Connecting a Transair Ø 76 to a Transair Ø 100 system to a Transair Ø 63, Ø 40, Ø 25 or Ø 16.5 system

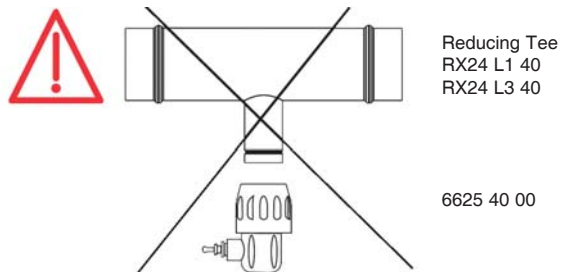
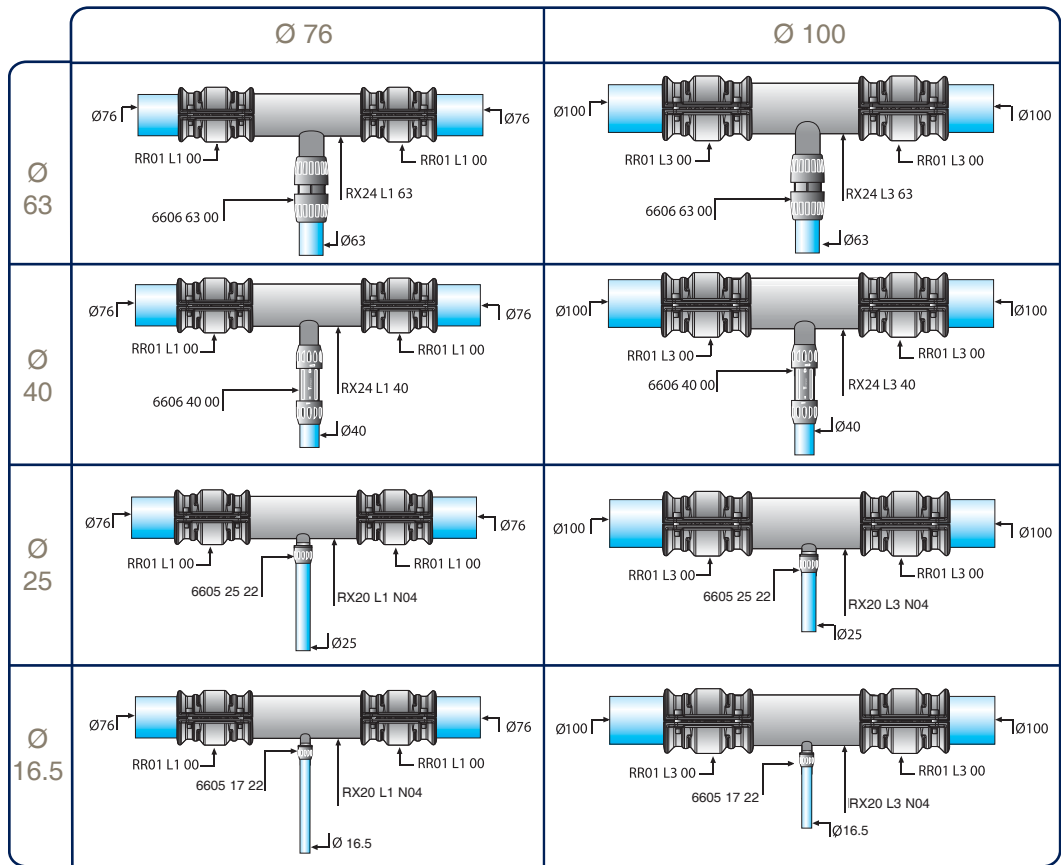

> Lateral dismantling

> Ø 16.5
Ø 25
Ø 40

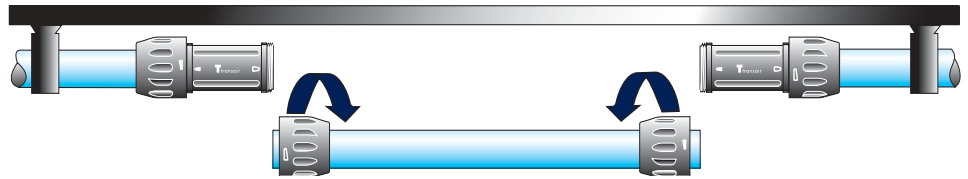

Loosen the nuts located on the side of the pipe to be removed and slide them along the pipe. Then remove the pipe.

> Ø 63

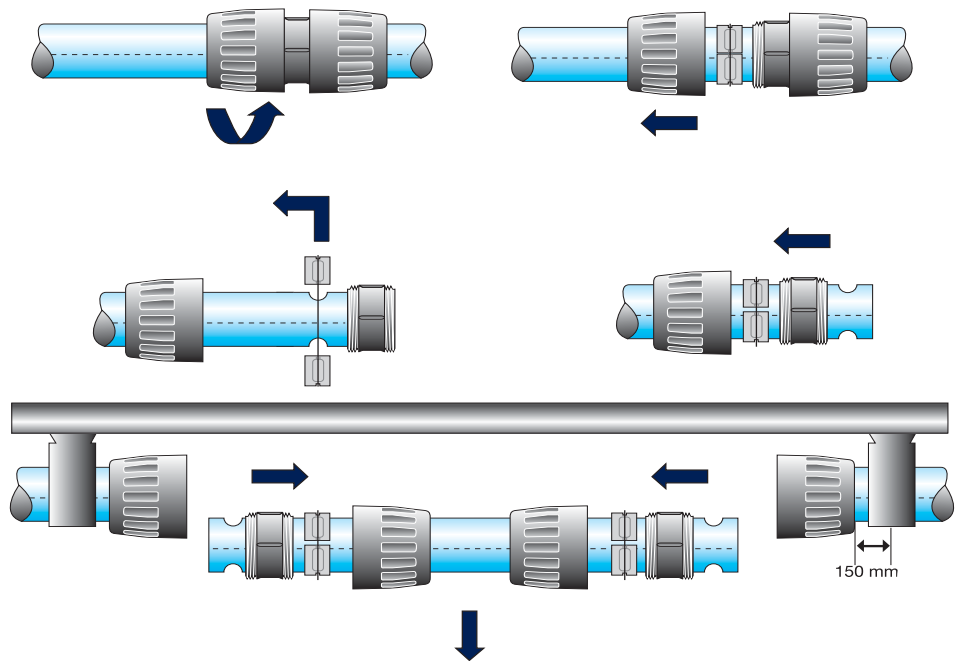

- 1 - Loosen the connector nuts on the ends of the pipe to be removed
- 2 - Slide them along the pipe
- 3 - Remove the clamp rings from their housings

- 4 - Slide the clamps and the connector body along the pipe which is to be removed
- 5 - Repeat the operation at the other end of the pipe and laterally remove the pipe, complete with the assembly components

> Transair connectors

> Practical examples

> Transair Ø 40 remote shut-off valve

> Application

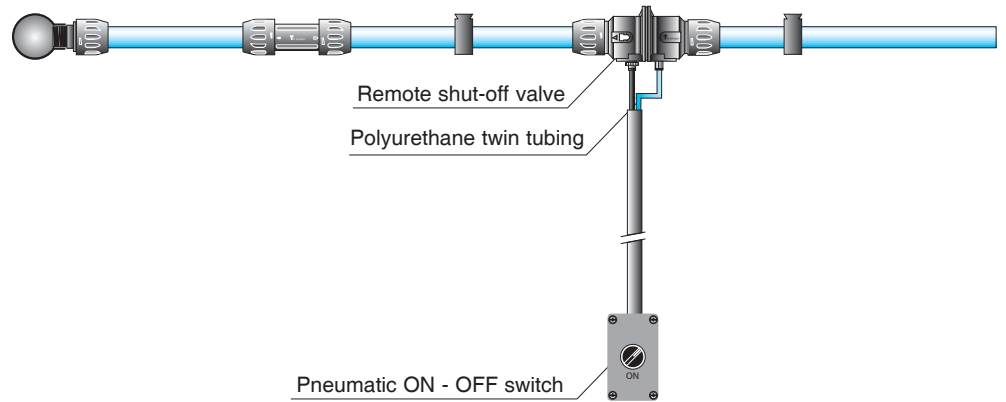

The Transair Ø 40 remote shut-off valve allows network supply to be rapidly and safely opened and closed either at ground level or by remote control.

The Transair remote shut-off valve guarantees:

- Personal safety, by eliminating all hazards related to working at heights
- Servicing speed, by removing the need for special access equipment (ladder, platform etc)

> Operating principle

Single acting valve - normally closed.

For compressed air systems:

The valve control pressure can be taken upstream of the isolating valve, with no external power supply. Control is performed through the control unit connected to the valve by means of a push-in connector.

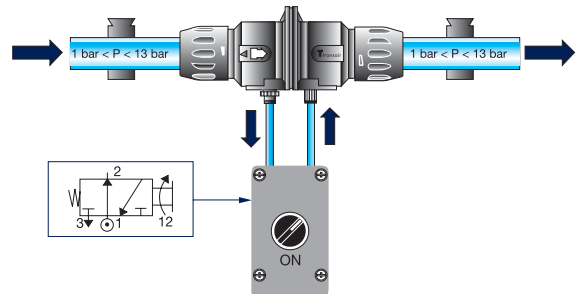

For vacuum systems:

A compressed air supply external to the control unit is required, and the corresponding valve port must be closed in order to prevent loss.

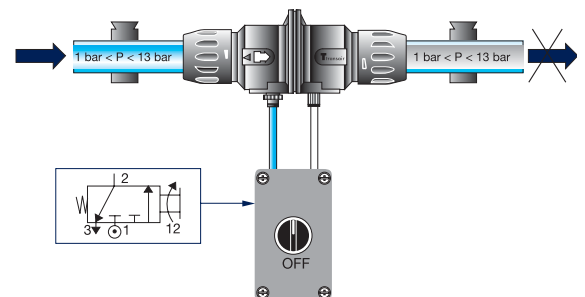

> Do's

> Connection

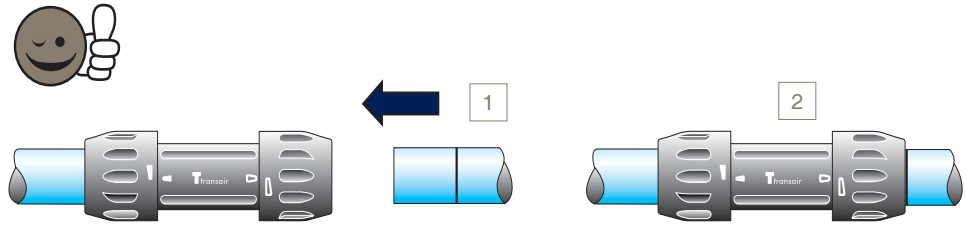

> Use a pipe cutter

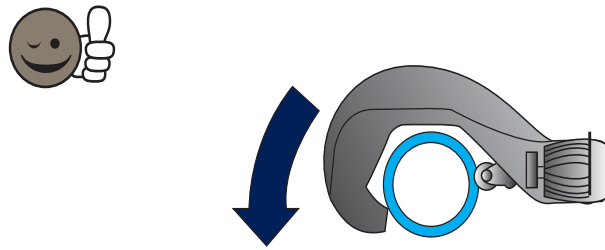

> Carefully Chamfer and deburr the pipe after cutting or drilling

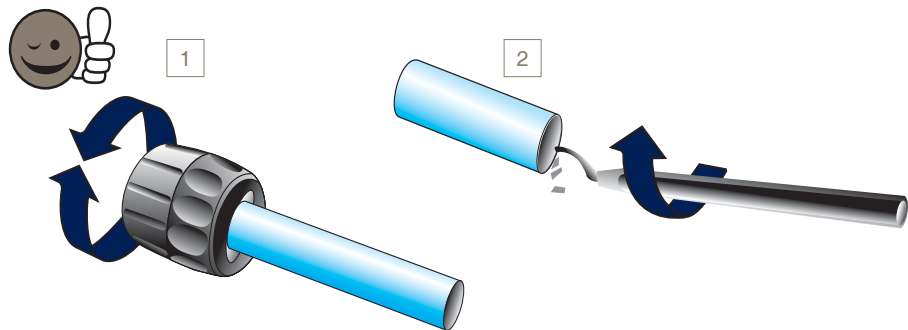

> Check that the pipe is correctly positioned in the connector

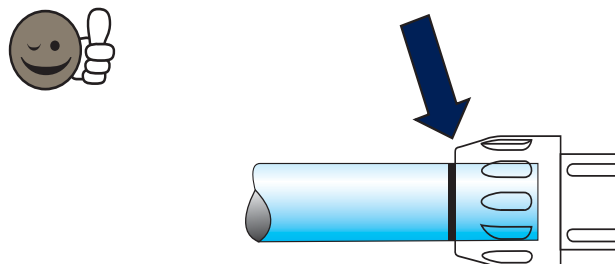

> Transair connectors

> Don'ts

> Loosen the nuts during assembly

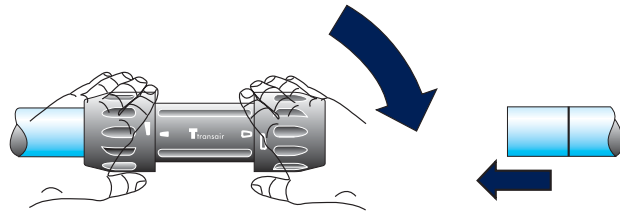

> Cut the pipe with a saw

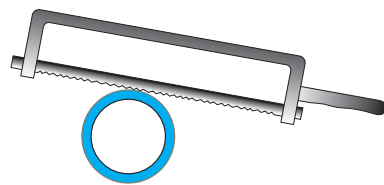

> Use non-deburred pipe

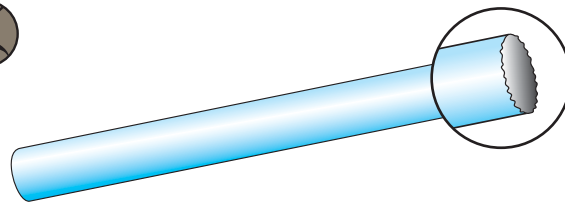

> Fail to make the pipe secure

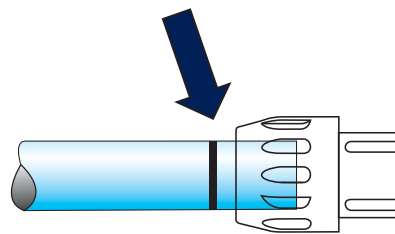

> Connect 40mm end cap to reducing tee

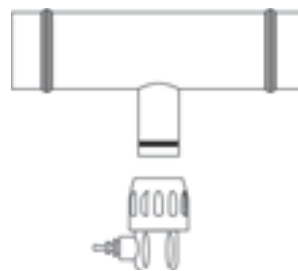

> Transair quick assembly brackets

> General

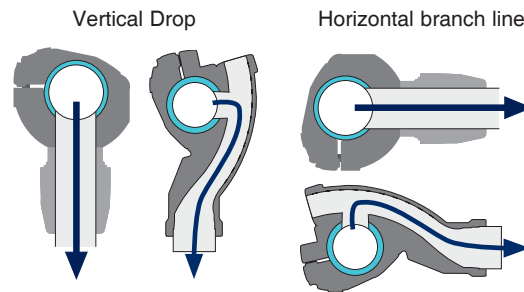

The easy addition of a new drop or bypass onto an existing length of pipe is an important consideration of any air pipe system. Transair quick assembly brackets are designed for this very purpose, without the need to cut the pipe. A "swan neck" built into the brackets retains condensate water in the main line. Thanks to its small size, the Transair quick assembly bracket facilitates new additions in the tightest places and can be used for connecting horizontal branch lines and vertical drops.

> Specific instructions for installing a bracket

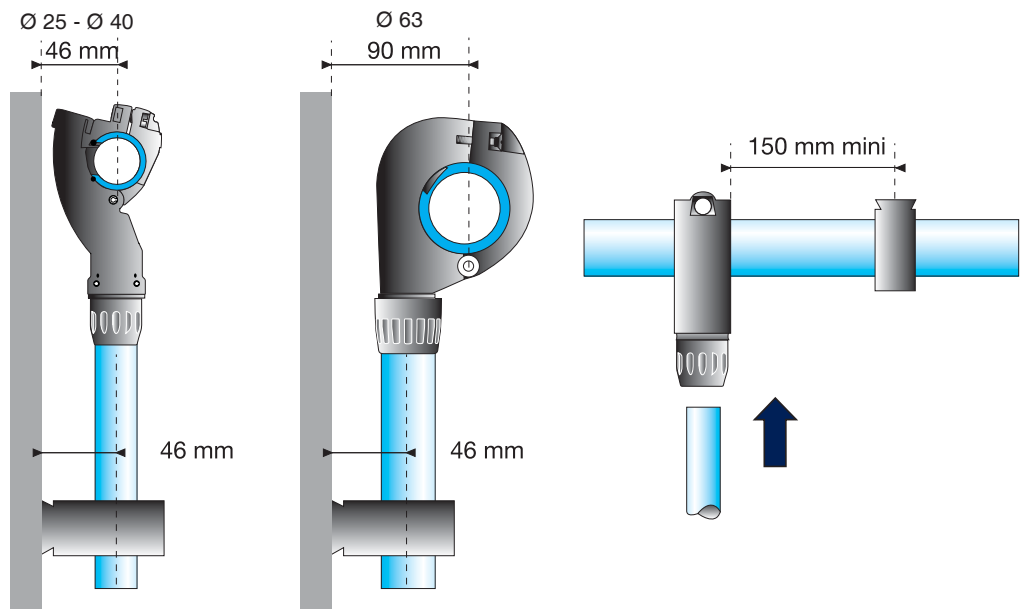

For the $\text{Ø} 25$ and $\text{Ø} 40$ Transair quick assembly brackets, the pipe center to wall distance is equal to the bracket center to wall distance, i.e. 46mm. For the $\text{Ø} 63$ Transair quick assembly brackets, the pipe center to wall distance is 90mm and the $\text{Ø} 25$ and $\text{Ø} 40$ bracket center distance is 46mm. Furthermore, Transair clips should be fitted at a distance of at least 150mm from a quick assembly bracket in order to allow for the expansion / contraction of aluminum pipe.

> Transair quick assembly brackets

> Installing a quick assembly bracket

> To
Ø 25 or Ø 40
pipe

> Tools required



Drilling tool for
aluminum pipe
ref. 6698 02 02
or 6698 02 01

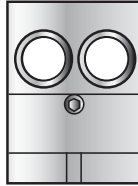

Drilling jig for
aluminum pipe
ref. 6698 01 01



Deburring tool for
aluminum pipe
ref. 6698 04 02



Permanent
marker pen



Allen key
/ Flat end
screwdriver

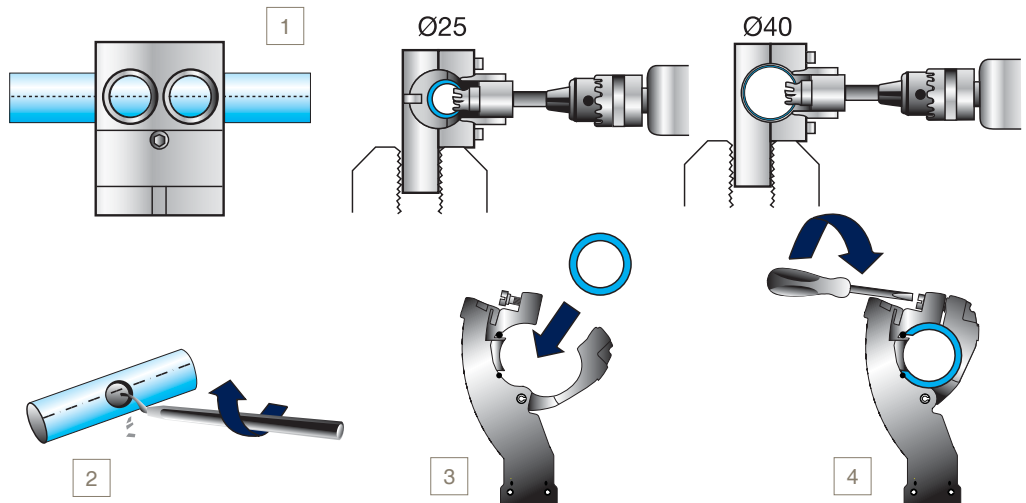

> Procedure

- 1 - Mark the pipe at the desired position for the bracket, using the same locator mark when several take-off points need to be aligned uniformly. Place the drilling jig ref. 6698 01 01 in a vice or on the floor. To drill a Ø 40 hole, remove the retaining bolt in the jig using an Allen key and place the pipe in the jig. The locator mark on the pipe should be aligned with the appropriate guide marks on the side of the jig. Two guide lines on either side of the jig provide a rapid indication of whether the pipe is correctly positioned (the guide lines match the locator marks on the pipe). Close the jig and drill a hole using the appropriate drilling tool:
 - Ø 25: Ø 16 hole > ref. 6698 02 02 drilling tool
 - Ø 40: Ø 22 hole > ref. 6698 02 01 drilling tool
 Recommended rotation speed: 650 rpm
 Note: drill without lubrication.
- 2 - Release the pipe, remove any chips and deburr the circular hole. Repeat the operation for the number of brackets that you wish to fit.
- 3 - Position the quick assembly bracket using its location pin
- 4 - Tighten the screw

Note: The jig's second drilling guide corresponds to the minimum distance for fitting two adjacent brackets.

> Installing a bracket

> On Ø 63 pipe

> Tools required



Drilling tool for aluminum pipe
ref. 6698 02 01

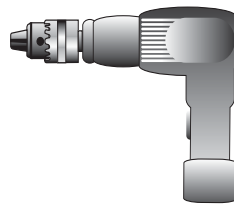

Drill

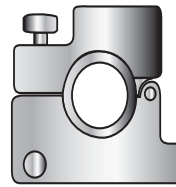

Drilling jig for aluminum pipe
ref. 6698 01 02



Deburring tool for aluminum pipe
ref. 6698 04 02



Permanent marker pen

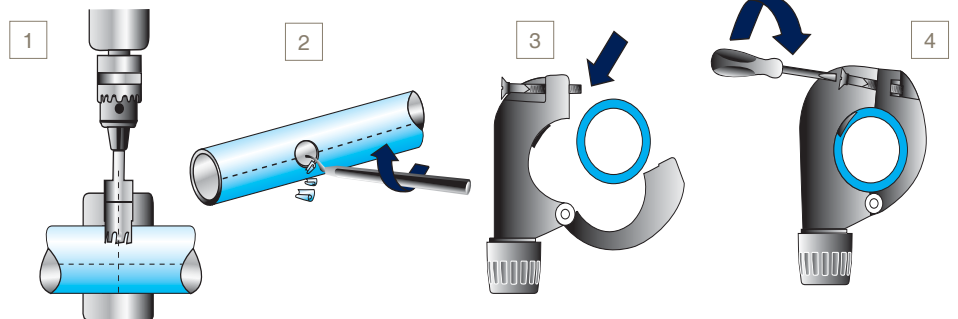

> Procedure

- 1 - Mark the pipe at the desired position for the bracket. The mark should be placed on one of the locator marks so that multiple brackets are correctly aligned, when several take-off points are required. Place the Ø 63 drilling jig in a vice or on the floor and place the pipe in the jig. Ensure that the line marked on the pipe is centred within the drilling guide: two marks on either side of the jig's upper side provide a rapid indication of the pipe's positioning. Tighten the locking clamp to secure the pipe and drill using the Ø 22 drilling tool. [Recommended rotation speed: 650 rpm]
Note: Drill without lubrication.
- 2 - Loosen the locking clamp and release the pipe, remove any chips and deburr the hole. Repeat the operation for the number of brackets that you wish to fit.
- 3 - Position the quick assembly bracket using its location hole
- 4 - Tighten the screw

> Transair quick assembly brackets

> Installing a bracket

> On \varnothing 76, \varnothing 100
or \varnothing 168 pipe

> Tools required



Drilling tool for aluminum pipe, ref. EW09 00 30 (\varnothing 76 - \varnothing 100) or EW09 00 64 / EW09 00 51 (\varnothing 168)



Deburring tool for aluminum pipe ref. 6698 04 02

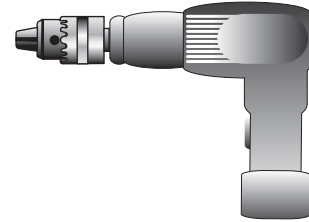

Drill

> Procedure

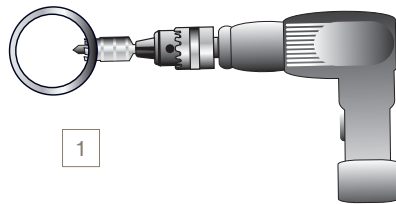

1

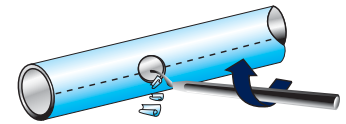

2

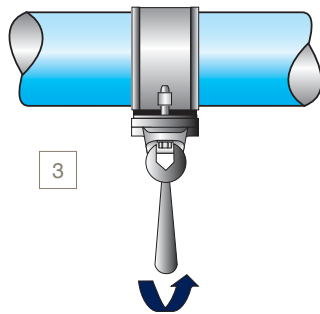

3

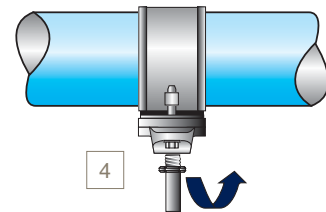

4

1 - Drill the aluminum pipe at the desired position using drilling tool ref.

2 - Carefully deburr the pipe

3 - Position bracket ref. RR61 and fully tighten the two screws

4 - Screw on male adapter

Note: Use adapter ref. 6621 25 35 in combination with bracket ref. RR63 to create a \varnothing 25 take-off point from \varnothing 76 or \varnothing 100 pipe.

> Practical examples

> Creating vertical and horizontal take-off points

Using the same locator mark

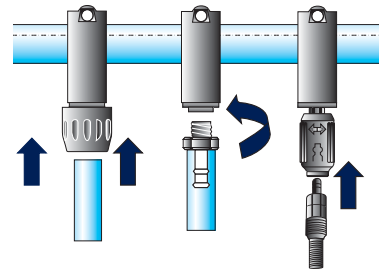

> Adding a vertical bracket

> Adding an off-set bracket

Using two locator marks

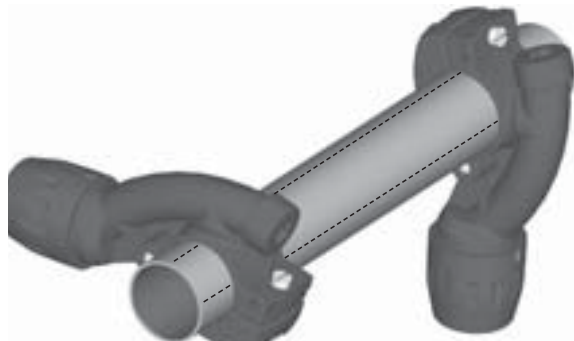
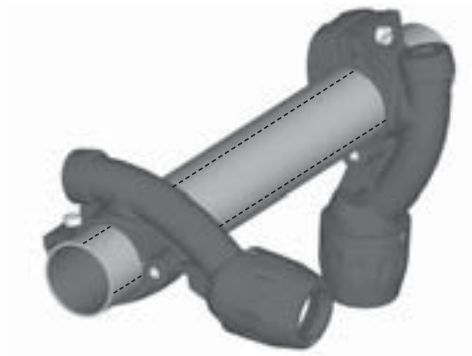

> Transair quick assembly brackets

> Installing a bracket to a pressurised system

> Tools required

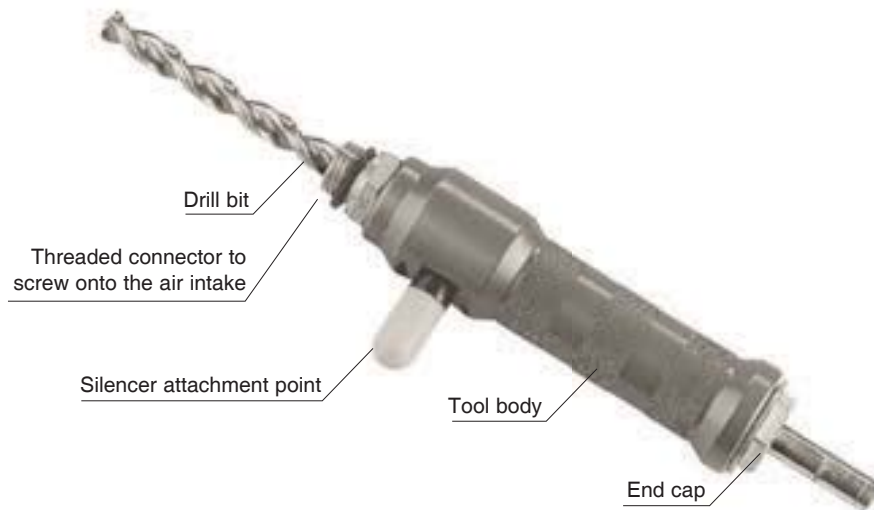

Use the under pressure drilling tool to fit a bracket to an existing pressurized system. This can be simply done with use of a standard drill.

> Procedure

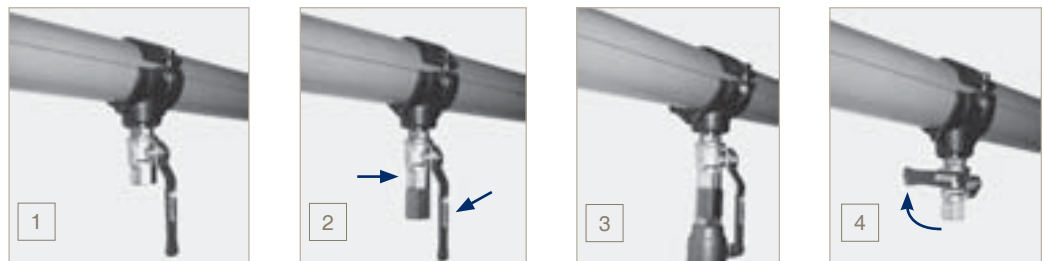

- 1 - Position the pressurized system bracket and fully tighten the two screws
- 2 - Screw the assembly onto the ball valve and ensure that the valve is open

- 3 - Screw the drilling tool onto the ball valve until complete
- 4 - Remove the drill and close the ball valve immediately and dismantle the drilling tool

> Transair flexible hose

> General

Transair flexible hose can be easily connected to other Transair components and can be rapidly installed without prior preparation or cutting. Thanks to its small bend radius, it requires minimum space and avoids mechanical stress within the system. Transair flexible hose is resistant to both compressor oils and fire.

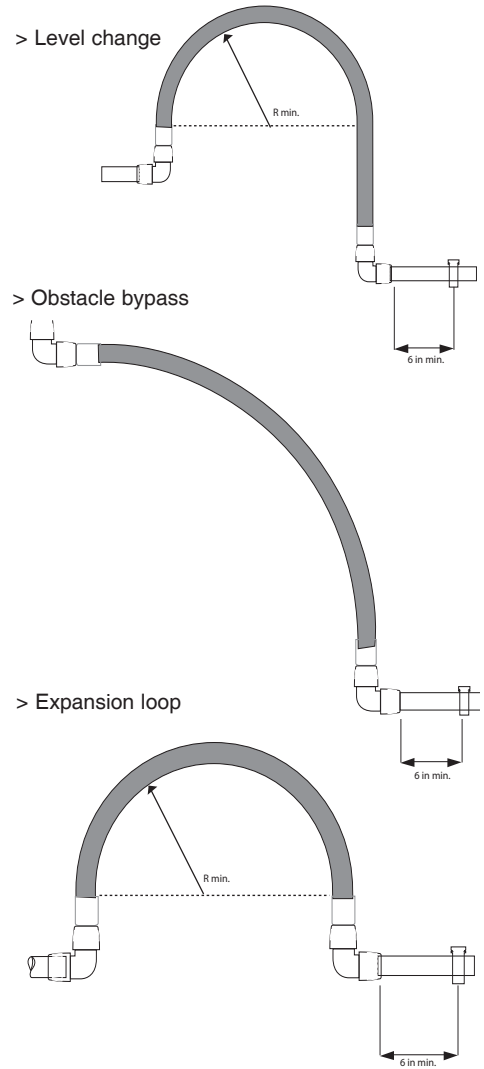

> Applications

Ø (mm)	Length (in)	Transair	R min (in)
25	22	1001E25 00 01	4
25	59	1001E25 00 03	4
25	79	1001E25 00 04	4
25	22	1001E25V00 01	3
25	59	1001E25V00 03	3
25	79	1001E25V00 04	3
40	45	1001E40 00 02	16
40	79	1001E40 00 04	16
40	118	1001E40 00 05	16
40	37	1001E40V00 07	6
40	79	1001E40V00 04	6
40	118	1001E40V00 05	6
63	55	1001E63 00 08	12
63	118	1001E63 00 05	26
63	157	1001E63 00 06	26
63	118	1001E63V00 05	10
63	157	1001E63V00 06	10
76	59	FP01 L1 01	14
76	79	FP01 L1 02	14
100	79	FP01 L3 01	18
100	118	FP01 L3 03	18

> Safety

> Anti-whiplash straps



In order to avoid the risk of whiplash accidents, Transair recommends the use of anti-whiplash straps, which are placed on either side of the connection. If Transair flexible tube is exposed to tear, the anti-whiplash assembly prevents it from snaking (safety device in accordance with ISO 4414 standard).

> Transair flexible hose

> System connection

> Ø 16.5
Ø 25
Ø 40

> Using a male threaded fitting

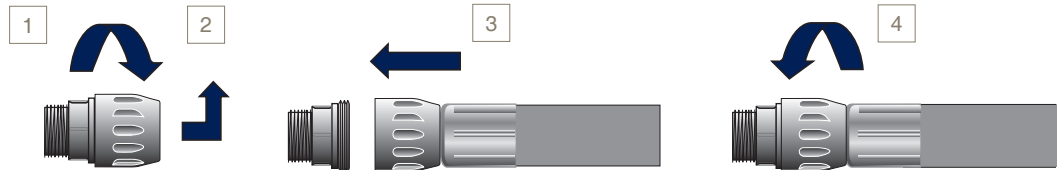

1 - Loosen the nut on the stud fitting
2 - Remove it

3 - Move the swaged end of the hose onto the exposed stud thread
4 - Tighten the nut

> Using a pipe to pipe connector

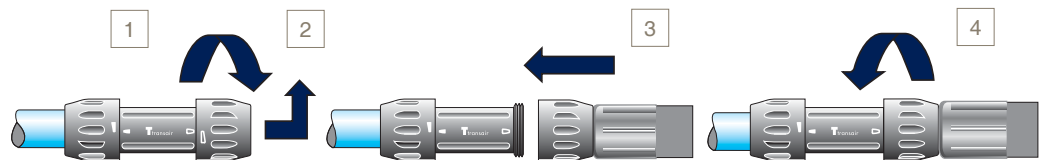

1 - Loosen the nut on the connector
2 - Remove it

3 - Move the swaged end of the hose onto the connector thread
4 - Tighten the nut

> Using a 90° elbow

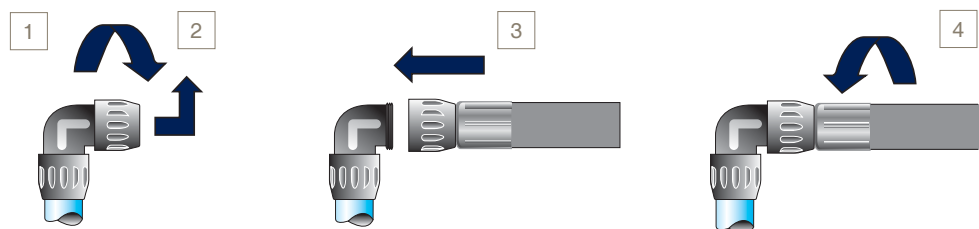

1 - Loosen the nut on the elbow
2 - Remove it

3 - Move the swaged end of the hose onto the elbow thread
4 - Tighten the nut

> Ø 63

> Using a male threaded fitting

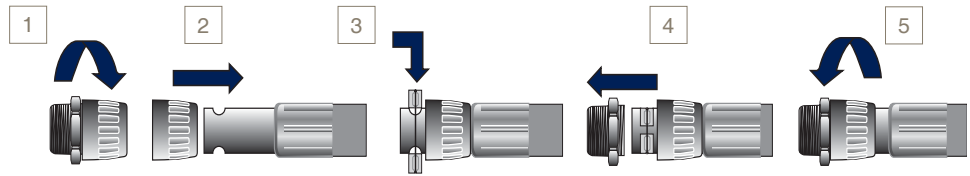

- 1 - Loosen the nut on the stud fitting and remove it
- 2 - Place the nut over the swaged end of the flexible hose
- 3 - Place the pipe connector clamps in the housings on the hose

- 4 - Slide the nut forward to the end of the flexible hose and assemble onto the male thread
- 5 - Tighten the nut using the Ø 63 spanner set

> Using a pipe to pipe connector

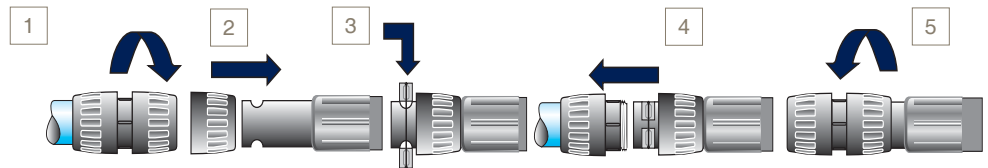

- 1 - Loosen the nut on the connector and remove it
- 2 - Fit it over the swaged end of the flexible hose
- 3 - Place the pipe connector clamps in the housings on the hose

- 4 - Slide the nut forward to the end of the flexible hose, until it touches the clamps
- 5 - Tighten the nut using the Ø 63 spanner set

> Using a 90° elbow

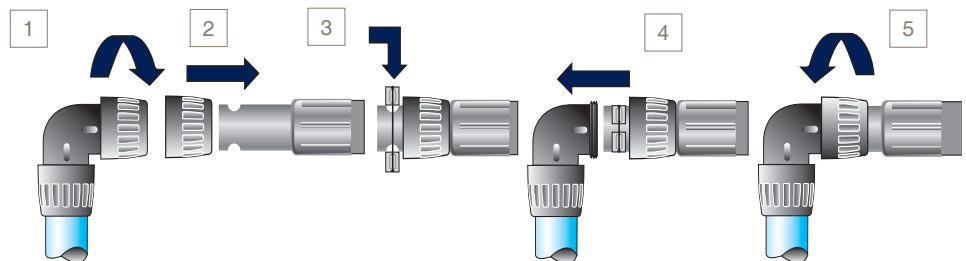

- 1 - Loosen the nut on the elbow and remove it
- 2 - Fit it over the swaged end of the flexible hose
- 3 - Place the elbow clamps in the housings on the hose

- 4 - Slide the nut forward to the end of the flexible hose, until it touches the clamps
- 5 - Tighten the nut using the Ø 63 spanner set

> System connection

> Ø 76
Ø 100
Ø 168

> Using a steel clamp

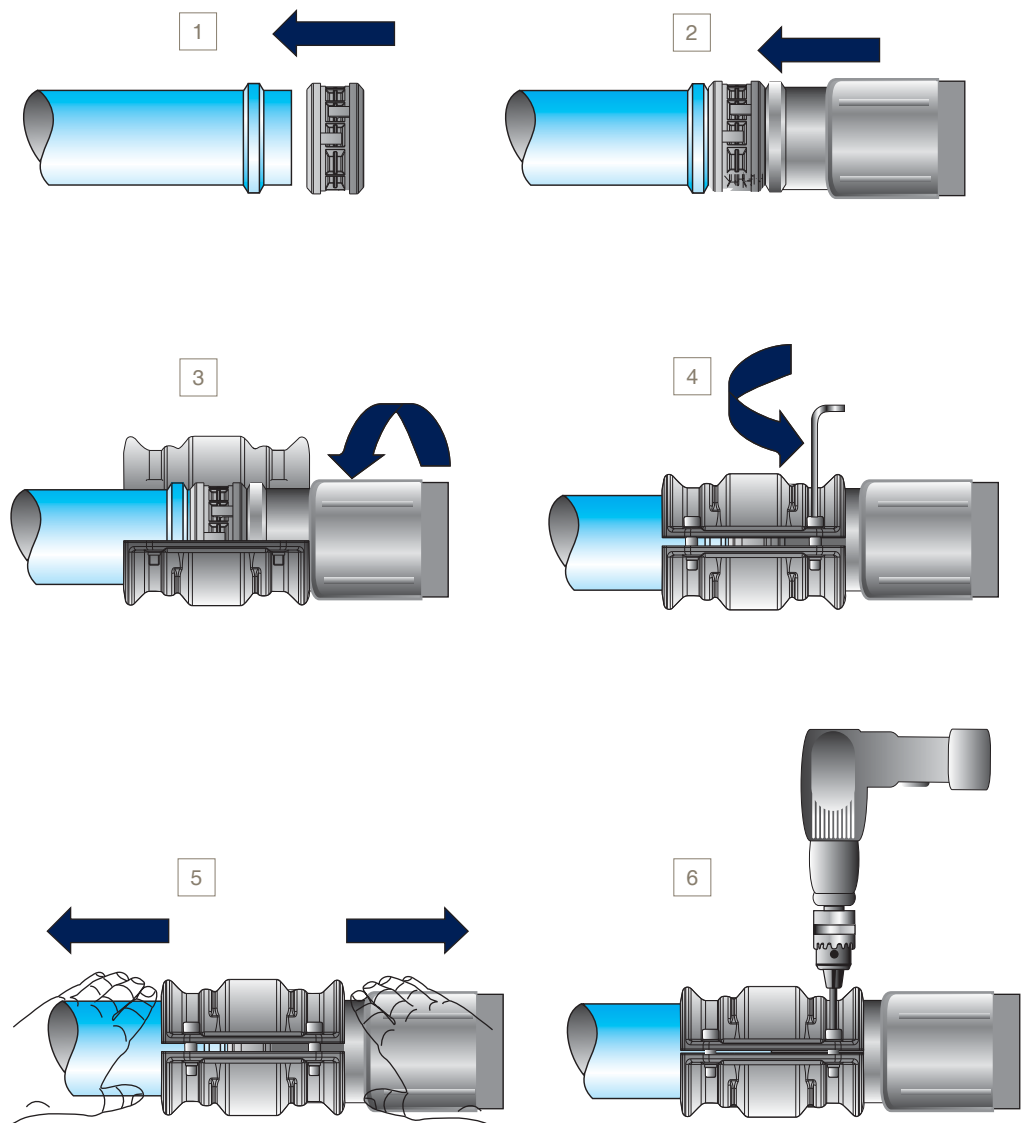

> Do's / don'ts

> Do's

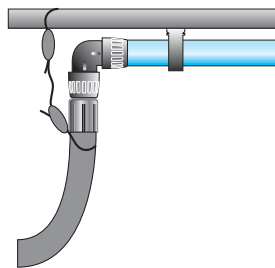
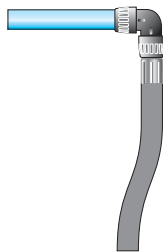
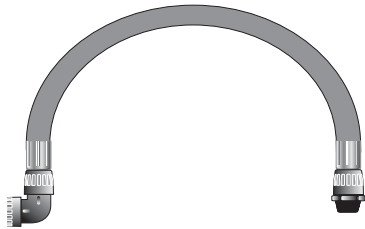
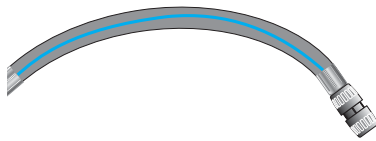
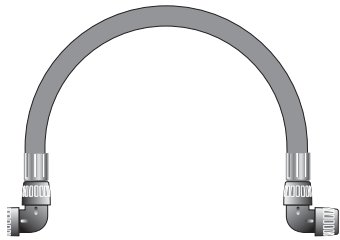
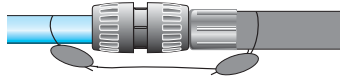

> Don'ts

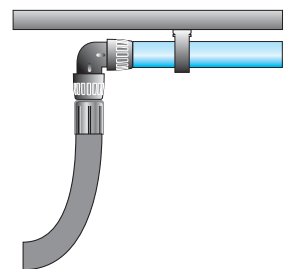
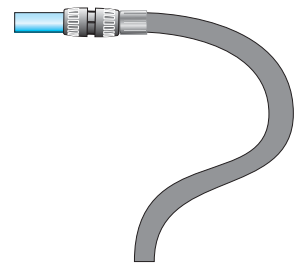
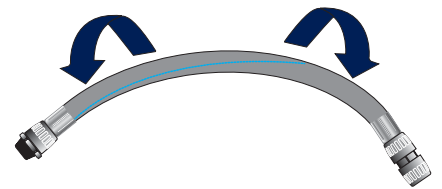
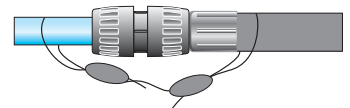

> Fixture accessories

> Transair attachments

> Transair clip for \varnothing 16.5, \varnothing 25, \varnothing 40 and \varnothing 63 rigid pipe

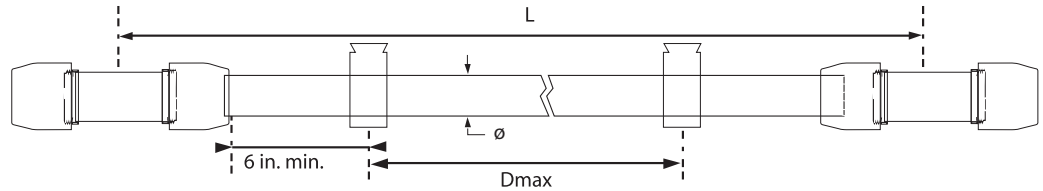

The Transair fixing clip is the basic component for mounting pipe when installing a \varnothing 16.5 – \varnothing 25 – \varnothing 40 – \varnothing 63 Transair aluminum system. This clip allows expansion and contraction of the pipe to occur freely.

To ensure good system stability, we recommend the use of at least two clips per pipe. Transair aluminum pipe should only be mounted using Transair and should not be substituted by any other type of components.

\varnothing	L (ft)	Dmax (ft)
16.5	10	8
25	10	8
25	20	10
40	10	8
40	20	10
63	20	10

> Properties

- Transair fixing clips for \varnothing 16.5 - \varnothing 25 - \varnothing 40: 1/4" nuts
- Transair fixing clips for \varnothing 63 systems: 3/8" nuts

> Procedure

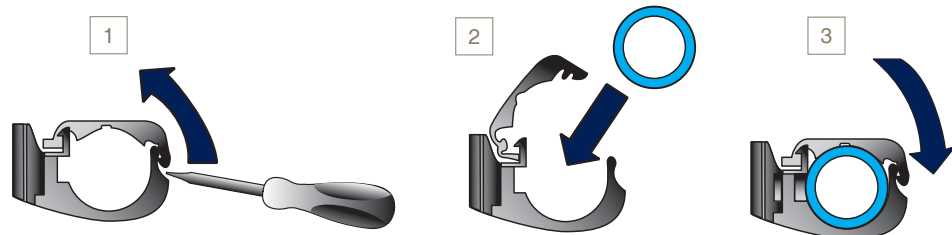

- 1 - Place the clip as required and open it using a screwdriver
- 2 - Insert the pipe into the clip
- 3 - Close the clip

> Spacer

The Transair 6697 00 03 spacer is used for adjusting a run of Transair pipe using different diameters.



Example:

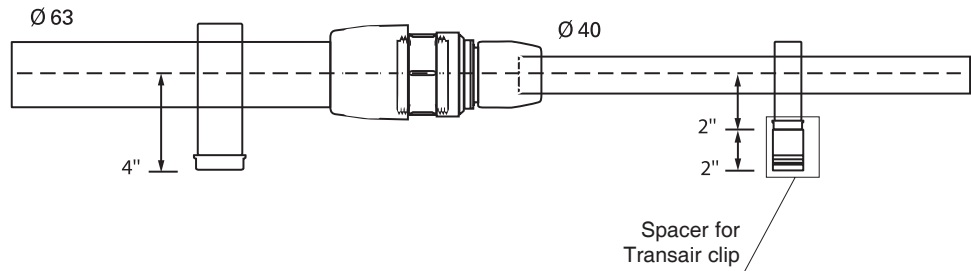

> Transair fixing clips for Ø 76 - Ø 168 systems

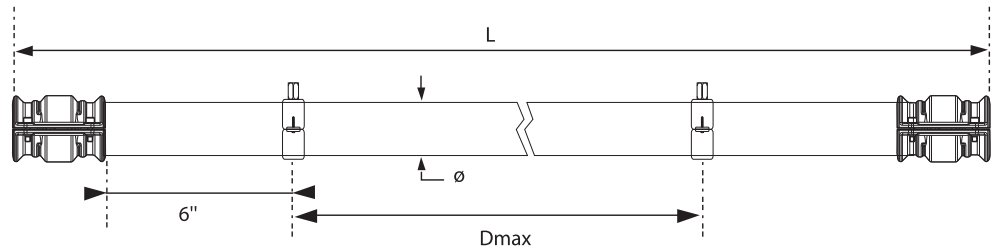

Ø	L (ft)	Dmax (ft)
76	20	16
100	20	16
168	20	16

To ensure good system stability, we recommend the use of at least two fixing clips per length of pipe. Transair fixing clips for Ø 76 - Ø 168 systems: 3/8" thread.

> Fixture accessories

> Supporting a Transair system

> Directly onto a wall

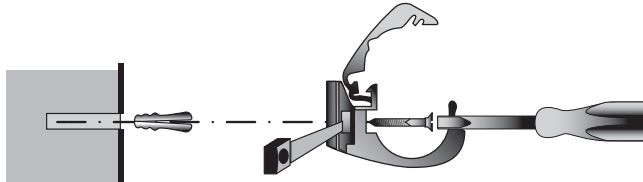

1

1 - Remove the nut at the base of the pipe clip using a screwdriver and insert the screw by passing it through the clip

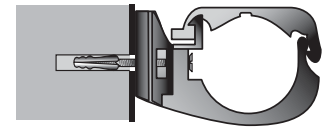

2

2 - Tighten the screw

> Offset from a wall

> U-channel type mounting bracket

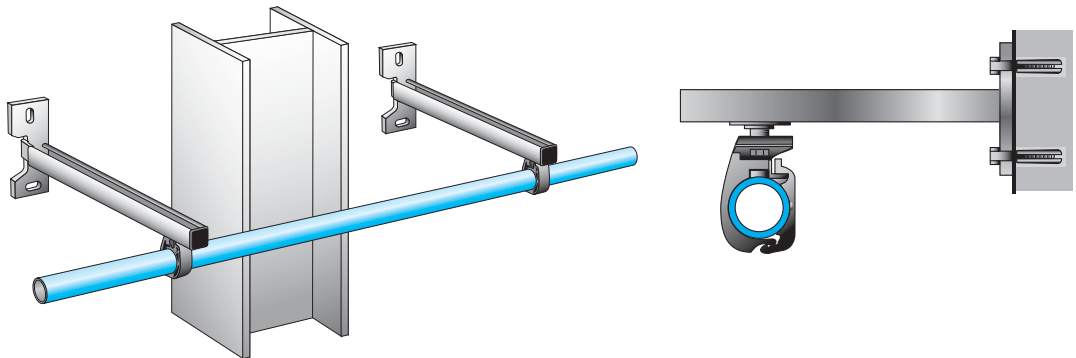

U-channel assemblies are used to offset systems and to bypass obstacles.

> Threaded rod adapter

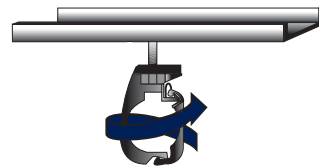

Ø 16.5 - Ø 40

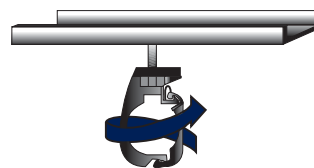

Ø 63

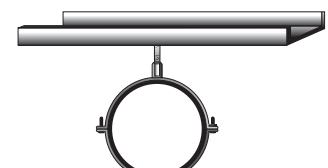

Ø 76 - Ø 168

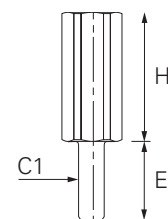

C1: 1/4"

The Transair threaded rod adaptor allows Ø 16.5, Ø 25 and Ø 40 Transair pipe clips to be easily suspended under 3/8" threaded rod.

> On a metal beam

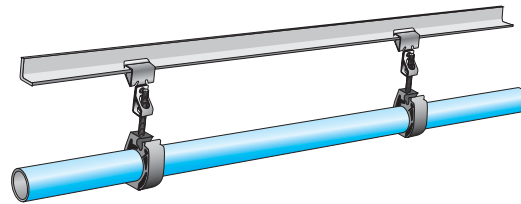

Push-on type beam clamps

> Using beam clamps

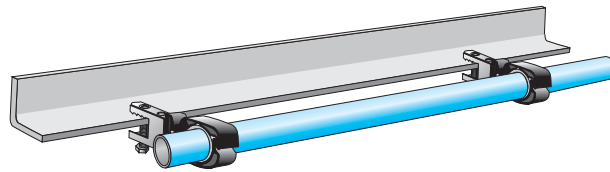

Screw type beam clamps



> Practical information

> Z dimensions

Transair	Z (mm)	Z1 (mm)	Z2 (mm)
4002 40 00	-	57	57
4002 63 00	-	84	98
4089 17 00	-	29	42
4088 25 14	-	40	55
4099 17 00	-	29	42
4099 25 00	-	40	55
4230 00 40	85	-	-
6612 25 00	29	-	-
6612 40 00	45	-	-
6602 17 00	31	-	-
6602 25 00	40	-	-
6602 40 00	62	-	-
6602 63 00	61	-	-
6604 17 00	-	34	31
6604 25 00	-	48	40
6604 40 00	-	57	57
6604 63 00	-	61	61
6604 63 40	-	61	116
6606 17 00	33	-	-
6606 25 00	48	-	-
6606 40 00	57	-	-
6606 63 00	25	-	-
6651 25 12 04	107	-	-
6651 40 12 04	150	-	-
6662 25 00	52	-	-
6662 25 17	59	-	-
6662 40 17	75	-	-
6662 40 25	68	-	-
6662 63 25	75	-	-
6666 17 25	50	-	-
6666 25 40	71	-	-
6676 17 00	33	-	-
6676 25 00	48	-	-
6676 40 00	57	-	-
6676 63 00	25	-	-
RA02 L8 00	185	-	-
RA04 L8 00	-	180	185
RA04 L8 L3	-	165	185
RA04 L8 L1	-	165	185
RA04 L8 63	-	165	220
RA66 L8 L1	210	-	-
RA66 L8 L3	210	-	-
RA69 25 17	47.5	-	-
RA69 40 25	61	-	-
RX02 L1 00	189	-	-
RX02 L3 00	221	-	-
RX04 L1 00	-	145	145
RX04 L3 00	-	155	135
RX04 L3 L1	-	155	135
RX23 L1 04	145	-	-
RX23 L3 04	155	-	-
RX24 L1 40	-	145	228
RX24 L1 63	-	145	285
RX24 L3 40	-	155	241
RX24 L3 63	-	155	298
RX64 L1 63	352	-	-
RX64 L3 63	372	-	-
RX66 L3 L1	193	-	-
VR02 L1 00	116	-	-
VR02 L3 00	123	-	-
VR02 L8 00	128	-	-

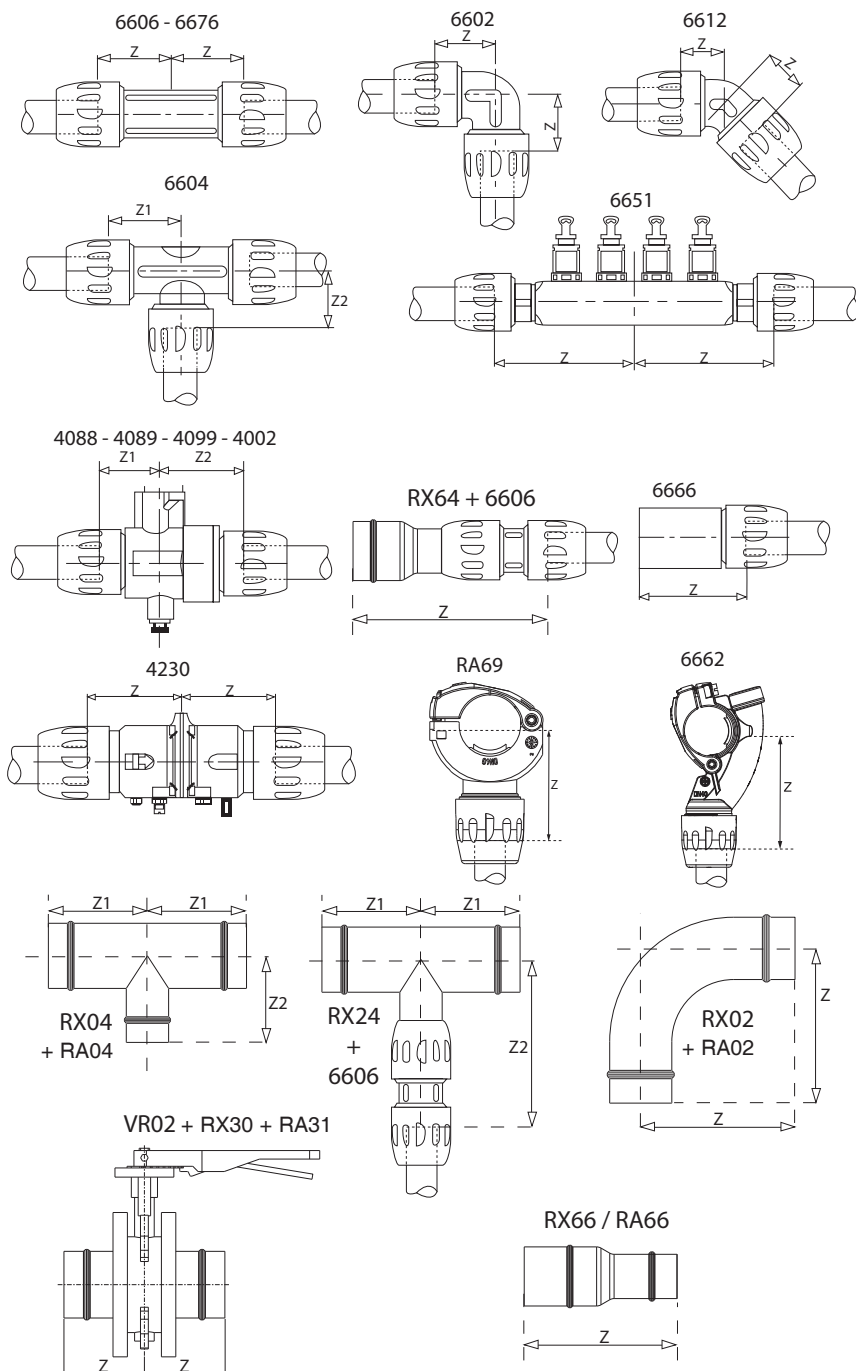

> Expansion / contraction

In order to compensate for the effects of expansion and contraction due to variations in temperature, any fluctuations in the length of the Transair aluminum pipe system should be calculated.

L: length of Transair straight line to be installed (in m)

ΔT : difference between temperature when installing and maximum operating temperature (in °C)

ΔL : line length variation (in mm)

For Transair $\varnothing 16.5 - \varnothing 25 - \varnothing 40 - \varnothing 63 - \varnothing 76 - \varnothing 100$ aluminum pipe systems:

$$\Delta L = \frac{(a \times L)}{1} + \frac{(0.024 \times L \times \Delta T)}{2}$$

1 - Expansion related to pipe retraction in the connector

2 - Expansion related to temperature variations

	$\varnothing 16.5$	$\varnothing 25$	$\varnothing 40$	$\varnothing 63$	$\varnothing 76$	$\varnothing 100$
10 ft pipe	a=0.06	a=0.20	a=0.40	a=0.73	a=1.0	a=1.0
20 ft pipe	-	a=0.10	a=0.20	a=0.38	a=0.50	a=0.50

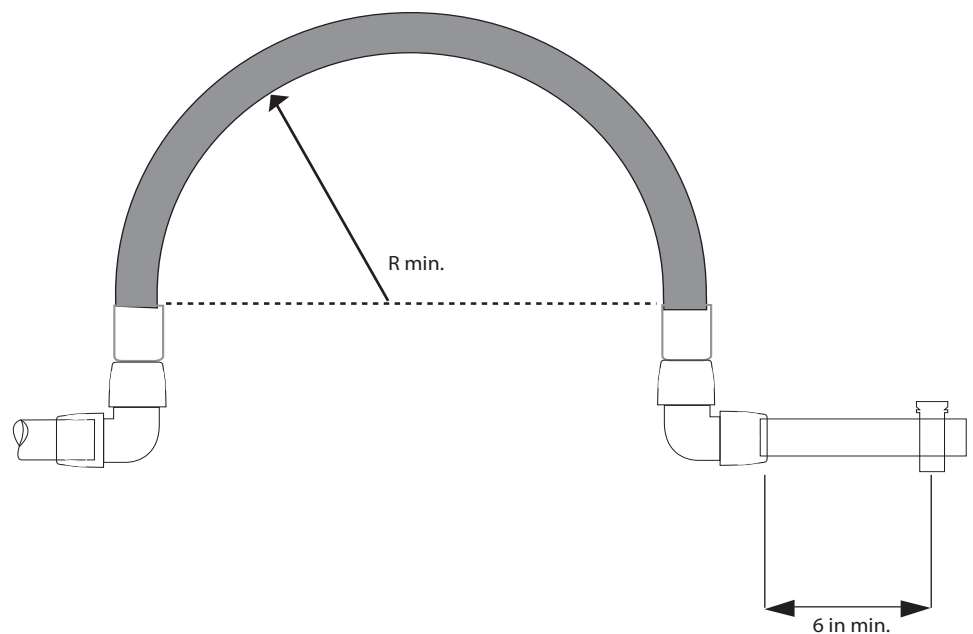

> Practical information

> Expansion / contraction

> Example

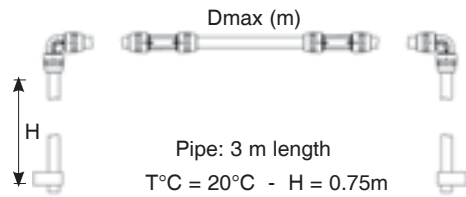

Case no. 1:
Maximum distance, without expansion loop, from a fixed point dependant on Transair diameter (2 elbows)

Ø Transair	16.5	25	40	63	76	100
Dmax. (m)	50	40	30	24	15	15

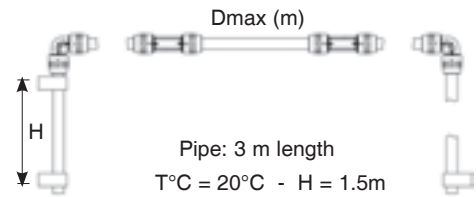

Case no. 2:
Maximum distance, without expansion loop, dependant on Transair diameter (2 elbows - 1 fixed point)

Ø Transair	16.5	25	40	63	76	100
Dmax. (m)	50	40	30	25	15	15

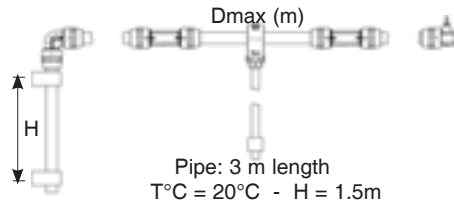

Case no. 3:
Maximum distance for installing a bracket, without expansion loop, dependant on Transair diameter (1 elbow - 1 bracket)

Ø Transair	16.5	25	40	63	76	100
Dmax. (m)	48	38	30	25	7.5	7.5

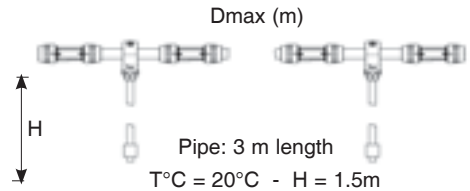

Case no. 4:
Maximum distance for installing a bracket, without expansion loop, dependant on Transair diameter (2 brackets)

Ø Transair	16.5	25	40	63	76	100
Dmax. (m)	80	70	55	40	15	15

> Direction change

In addition to expansion loops, changes of direction are another method of compensating for expansion and contraction.

> Using an elbow

> For Transair
 Ø 16.5 - Ø 25 - Ø 40 - Ø 63
 aluminum pipe systems

H= 29.5"	$\Delta L1= 0.6"$
H= 59.1"	$\Delta L1= 1.2"$

> For Transair
 Ø 76 - Ø 168
 aluminum pipe systems

H= 29.5"	$\Delta L1= 3/8"$
H= 59.1"	$\Delta L1= 6/8"$

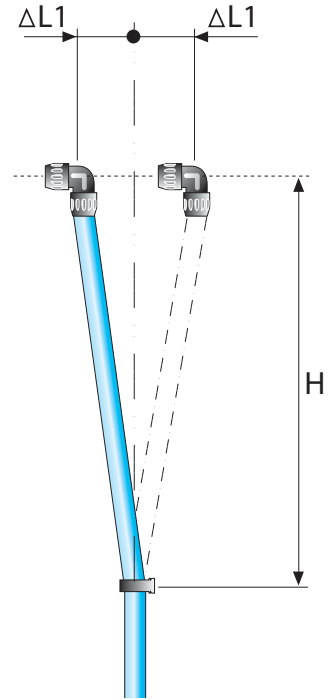

> Using a quick assembly bracket

> For Transair Ø 16.5 - Ø 25 - Ø 40 - Ø 63
 aluminum pipe systems

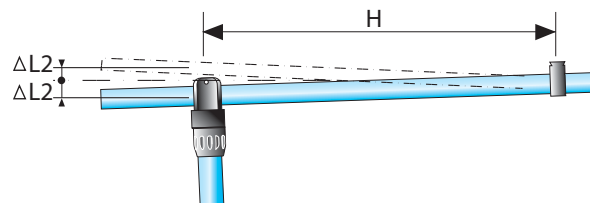

Ø1	Ø2	H (ft)	$\Delta L2$ (in)	$\Delta L3$ (in)
25	16.5	5	1/2	1
25	25	5	1/2	1
40	16.5	5	1/2	1
40	25	5	1/2	1
63	25	5	1/2	1

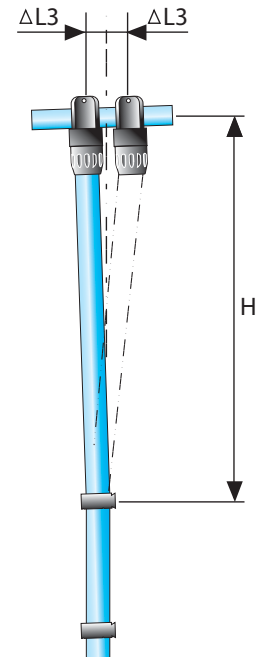

The length variation ΔL , calculated for the Transair line, must always be equal to or less than $\Delta L2$ and $\Delta L3$. If this is not the case, then an expansion loop, using Transair flexible hose, must be added.

> Practical information

> For Transair Ø 76 - Ø 168 aluminum pipe systems

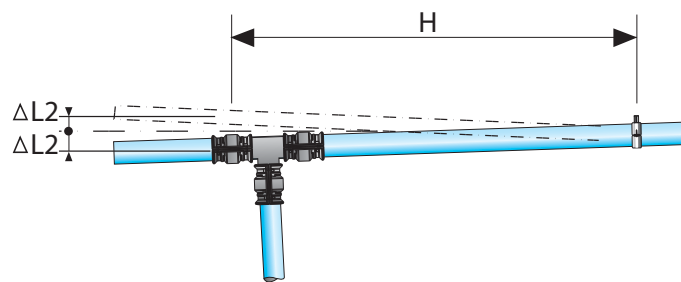

> Changing direction with a tee

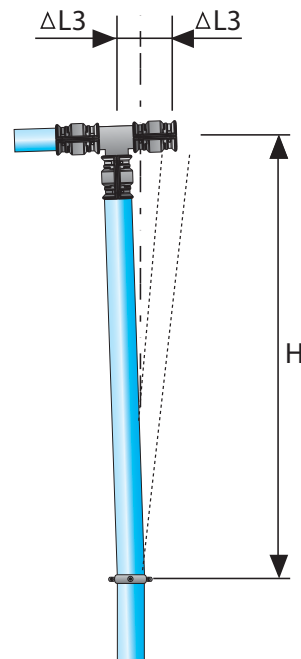

Ø	H (ft)	ΔL2 maxi (in)	ΔL3 maxi (in)
76	2 1/2	3/8	3/8
100	2 1/2	3/8	3/8
168	2 1/2	3/8	3/8

> Conversion charts

> Length

millimeter (mm)	meter (m)	inch (in)	foot (ft)	yard (yd)
10	0.01	0.39	0.03	0.01
20	0.02	0.79	0.07	0.02
30	0.03	1.18	0.10	0.03
40	0.04	1.57	0.13	0.04
50	0.05	1.97	0.16	0.05
60	0.06	2.36	0.20	0.07
70	0.07	2.76	0.23	0.08
80	0.08	3.15	0.26	0.09
90	0.09	3.54	0.30	0.10
100	0.10	3.94	0.33	0.11
150	0.15	5.91	0.49	0.16
200	0.20	7.87	0.66	0.22
250	0.25	9.84	0.82	0.27
300	0.30	11.81	0.98	0.33
350	0.35	13.78	1.15	0.38
400	0.40	15.75	1.31	0.44
450	0.45	17.72	1.48	0.49
500	0.50	19.69	1.64	0.55
550	0.55	21.65	1.80	0.60
600	0.60	23.62	1.97	0.65
700	0.70	27.56	2.30	0.76
800	0.80	31.50	2.62	0.87
900	0.90	35.43	2.95	0.98
1 000	1.00	39.37	3.28	1.09

> Pressure

Bar	Kilo Pascal (KPa)	Atmosphere (atm)	PSI	Torr (mm Hg)
1	100	0.99	14.50	750
2	200	1.97	29.00	1 500
3	300	2.96	43.50	2 250
4	400	3.95	58.00	3 000
5	500	4.93	72.50	3 750
6	600	5.92	87.00	4 500
7	700	6.91	101.50	5 250
8	800	7.90	116.00	6 000
9	900	8.88	130.50	6 750
10	1000	9.87	145.00	7 500
11	1100	10.86	159.50	8 250
12	1200	11.84	174.00	9 000
13	1300	12.83	188.50	9 750
14	1400	13.82	203.00	10 500
15	1500	14.80	217.50	11 250
16	1600	15.79	232.00	12 000
20	2000	19.74	290.00	15 000

> Practical information

> Flow rate

liters per second (l/s)	liters per minute (l/min)	cubic meters per minute (m ³ /min)	cubic meters per hour (m ³ /h)	cubic feet per minute (cfm)
10	600	0.60	36	21
20	1 200	1.20	72	42
30	1 800	1.80	108	64
40	2 400	2.40	144	85
50	3 000	3.00	180	106
60	3 600	3.60	216	127
70	4 200	4.20	252	148
80	4 800	4.80	288	169
90	5 400	5.40	324	191
100	6 000	6.00	360	212
150	9 000	9.00	540	318
200	12 000	12.00	720	424
250	15 000	15.00	900	530
300	18 000	18.00	1 080	635
350	21 000	21.00	1 260	741
400	24 000	24.00	1 440	847
450	27 000	27.00	1 620	953
500	30 000	30.00	1 800	1 059
550	33 000	33.00	1 980	1 165
600	36 000	36.00	2 160	1 271
700	42 000	42.00	2 520	1 483
800	48 000	48.00	2 880	1 694
900	54 000	54.00	3 240	1 906
1 000	60 000	60.00	3 600	2 118

> Air consumption values

Tools	Typical CFM consumption at an operating pressure of 87 psi
Small process controls, instrumentation, pneumatic logic units	4
Paint spray gun, small impact wrench, light/medium drill, blowgun	From 5 to 18
Polisher, screwdriver	25
Sheet metal cutter, large impact wrench, automatic plane	28
Small automatic machines, miscellaneous tooling	32
Large tools, power machines and associated equipment	36
Air hoist, grinder	74

> Transair systems in use



Packaging
Transair Ø 40 and Ø 25



Assembly workshop
Transair Ø 63 and Ø 25



Automotive
Transair Ø 40



Food and beverage
Transair Ø 25



Production workshop
Transair Ø 40



Alternative energy
Transair Ø 76 and Ø 63

> Transair systems in use



Waste management
Transair Ø 40



Pharmaceutical
Transair Ø 63



Industrial
Transair Ø 100



Outdoor installation
Transair Ø 168



Railways
Transair Ø 63



Inert gas
Transair Ø 25

> Part numbers index

Part Number	Pg.	Part Number	Pg.	Part Number	Pg.	Part Number	Pg.	Part Number	Pg.
0169 00 05 00	39	6605 63 44	24	6662 25 00	28	9084 30 18	42	FP01 L3 02	17
1001E25 00 01	17	6605 63 46	24	6662 25 17	28	9085 23 08	42	FP01 L3 03	17
1001E25 00 03	17	6606 17 00	18	6662 40 17	28	9085 23 56	42	RA02 L8 00	19
1001E25 00 04	17	6606 25 00	18	6662 40 25	28	9085 23 60	42	RA04 L8 00	21
1001E25V00 01	17	6606 40 00	18	6662 63 25	28	9085 30 08	42	RA04 L8 63	21
1001E25V00 03	17	6606 63 00	18	6663 25 22	28	9085 30 60	42	RA04 L8 L1	21
1001E25V00 04	17	6609 17 14	19	6663 40 22	28	9085 30 62	42	RA04 L8 L3	21
1001E40 00 02	17	6609 17 22	19	6663 63 22	28	CP05 A1N02	41	RA12 L8 00	20
1001E40 00 04	17	6609 25 22	19	6663 63 28	28	CP05 A1N03	41	RA25 L8 00	23
1001E40 00 05	17	6609 25 28	19	6666 17 25	22	CP05 A1N04	41	RA66 L8 L1	22
1001E40V00 04	17	6609 25 35	19	6666 25 40	22	CP05 U1N02	41	RA66 L8 L3	22
1001E40V00 05	17	6609 40 35	19	6666 40 63	22	CP05 U1N03	41	RA68 25N04	27
1001E40V00 07	17	6609 40 43	19	6668 25 22	28	CP05 U1N04	41	RA68 40N04	27
1001E63 00 05	17	6609 40 44	19	6668 40 22	28	CP05 U2N02	41	RA69 25 17	27
1001E63 00 06	17	6609 40 50	19	6668 63 22	28	CP05 U2N03	41	RA69 40 25	27
1001E63 00 08	17	6609 63 41	19	6668 63 28	28	CP05 U2N04	41	RP00 L1 00	18
1001E63V00 05	17	6609 63 46	19	6675 17 22	31	CP15 A1N02	41	RP00 L3 00	18
1001E63V00 06	17	6611 17 22	25	6675 25 22	31	CP15 A1N03	41	RR01 L1 00	18
1004A17 02	15	6611 25 22	25	6676 25 00	18	CP15 A1N04	41	RR01 L3 00	18
1004A17 04	15	6611 25 28	25	6676 40 00	18	CP15 U1N02	41	RR01 L8 00	18
1013A17 04 00	15	6611 25 35	25	6676 63 00	18	CP15 U1N03	41	RR21 L1N20	25
1013A17 06 00	15	6611 40 35	25	6679 17 22	31	CP15 U1N04	41	RR21 L1N24	25
1013A25 04 00	15	6611 40 43	25	6679 25 22	31	CP15 U2N02	41	RR63 L1N08	27
1013A40 04 00	15	6611 40 44	25	6684 17 22	30	CP15 U2N03	41	RR63 L3N08	27
1013A63 04	15	6611 40 50	25	6684 25 22	30	CP15 U2N04	41	RR63 L8N12	27
1016A25 02 00	15	6611 63 41	25	6688 22 22	30	CP21 A1 06	41	RR63 L8N16	27
1016A25 04 00	15	6611 63 44	25	6689 00 03	34	CP21 A1 08	41	RX02 L1 00	19
1016A25 06 00	15	6612 25 00	20	6689 17 22	30	CP21 A1 10	41	RX02 L3 00	19
1016A40 02 00	15	6612 40 00	20	6689 25 22	30	CP21 U1 06	41	RX04 L1 00	21
1016A40 04 00	15	6612 63 00	20	6691 22 22	30	CP21 U1 08	41	RX04 L3 00	21
1016A40 06 00	15	6615 25 22	24	6694 17 22	31	CP21 U1 10	41	RX04 L3 L1	21
1016A63 02	15	6615 25 28	24	6694 25 22	31	CP21 U2 08	41	RX12 L1 00	20
1016A63 04	15	6615 25 43	24	6696 25 22	31	CP21 U2 10	41	RX12 L3 00	20
1016A63 06	15	6615 40 15	24	6697 00 03	39	CP21 U2 13	41	RX20 L1N04	22
4002 40 00	32	6615 40 43	24	6697 17 01	38	EA98 06 00	29	RX20 L3N04	22
4002 63 00	32	6619 25 22	20	6697 25 01	38	EA98 06 00	36	RX24 L1 40	21
4012 63 00	32	6619 25 28	20	6697 40 01	38	EA98 06 01	29	RX24 L1 63	21
4088 25 14	32	6619 25 35	20	6697 63 01	38	EA98 06 02	29	RX24 L3 40	21
4089 17 00	32	6619 40 35	20	6698 01 01	34	EA98 06 03	29	RX24 L3 63	21
4099 17 00	32	6619 40 43	20	6698 01 02	34	ER01 L1 00	38	RX25 L1 00	23
4099 25 00	32	6619 40 44	20	6698 02 01	35	ER01 L3 00	38	RX25 L3 00	23
4230 00 40	33	6619 40 50	20	6698 02 02	35	ER01 L8 00	38	RX30 L1 00	26
4299 03 01	33	6619 63 40	20	6698 03 01	34	EW01 00 02	37	RX30 L3 00	26
6602 17 00	19	6621 17 22	25	6698 04 01	35	EW02 L1 00	37	RX31 L1 00	26
6602 25 00	19	6621 25 22	25	6698 04 02	35	EW02 L3 00	37	RX31 L3 00	26
6602 40 00	19	6621 25 28	25	6698 04 03	36	EW02 L8 00	37	RX31 L8 00	26
6602 63 00	19	6621 25 35	25	6698 05 03	36	EW03 00 01	37	RX64 L1 63	22
6604 17 00	21	6621 40 43	25	6698 11 11	40	EW05 L1 00	26	RX64 L3 63	22
6604 25 00	21	6621 40 50	25	6698 11 12	40	EW05 L3 00	26	RX66 L3 L1	22
6604 40 00	21	6625 17 00	23	6699 01 01	39	EW05 L8 00	26	TA06 L1 06	14
6604 63 00	21	6625 25 00	23	6699 01 02	39	EW06 00 01	26	TA16 L1 02	16
6604 63 40	21	6625 40 00	23	9083 22 14	42	EW06 00 05	26	TA16 L1 04	16
6605 17 14	24	6625 63 00	23	9083 22 18	42	EW08 00 01	34	TA16 L3 02	16
6605 17 22	24	6636 28 22	31	9083 23 14	42	EW08 00 03	34	TA16 L3 04	16
6605 25 22	24	6638 25 22	31	9083 23 18	42	EW09 00 22	35	TA16 L3 06	16
6605 25 28	24	6640 17 22	30	9083 30 14	42	EW09 00 30	35	TA16 L8 04	16
6605 25 35	24	6640 25 22	30	9083 30 18	42	EW09 00 51	35	VR01 L1 00	32
6605 40 35	24	6642 22 22	30	9084 22 14	42	EW09 00 64	35	VR01 L3 00	32
6605 40 43	24	6651 25 12 04	26	9084 22 18	42	EX01 L1 00	38	VR02 L1 00	33
6605 40 44	24	6651 40 12 04	26	9084 23 14	42	EX01 L3 00	38	VR02 L3 00	33
6605 40 50	24	6653 25 22 06	26	9084 23 18	42	FP01 L1 01	17	VR02 L8 00	33
6605 63 41	24	6653 40 22 06	26	9084 30 14	42	FP01 L1 02	17		

Parker's Motion & Control Product Groups

At Parker, we're guided by a relentless drive to help our customers become more productive and achieve higher levels of profitability by engineering the best systems for their requirements. It means looking at customer applications from many angles to find new ways to create value. Whatever the motion and control technology need, Parker has the experience, breadth of product and global reach to consistently deliver. No company knows more about motion and control technology than Parker. For further info call 1 800 C-Parker (1 800 272 7537).



Aerospace

Key Markets

Aftermarket services
Commercial transports
Engines
General & business aviation
Helicopters
Launch vehicles
Military aircraft
Missiles
Power generation
Regional transports
Unmanned aerial vehicles

Key Products

Control systems & actuation products
Engine systems & components
Fluid conveyance systems & components
Fluid metering, delivery & atomization devices
Fuel systems & components
Fuel tank inerting systems
Hydraulic systems & components
Thermal management
Wheels & brakes



Automation

Key Markets

Alternative energy
Conveyor & material handling
Factory automation
Food & beverage
Life sciences & medical
Machine tools
Packaging machinery
Paper machinery
Plastics machinery
Primary metals
Safety & security
Semiconductor & electronics
Transportation & automotive

Key Products

AC/DC drives & systems
Air preparation
Electric actuators, gantry robots & slides
Human machine interfaces
Inverters
Manifolds
Miniature fluidics
Pneumatic actuators & grippers
Pneumatic valves & controls
Rotary actuators
Stepper motors, servo motors, drives & controls
Structural extrusions
Vacuum generators, cups & sensors



Climate & Industrial Controls

Key Markets

Agriculture
Air conditioning
Construction Machinery
Food & beverage
Industrial machinery
Life sciences
Oil & gas
Precision cooling
Process
Refrigeration
Transportation

Key Products

Accumulators
Advanced actuators
CO₂ controls
Electronic controllers
Filter driers
Hand shut-off valves
Heat exchangers
Hose & fittings
Pressure regulating valves
Refrigerant distributors
Safety relief valves
Smart pumps
Solenoid valves
Thermostatic expansion valves



Filtration

Key Markets

Aerospace
Food & beverage
Industrial plant & equipment
Life sciences
Marine
Mobile equipment
Oil & gas
Power generation & renewable energy
Process
Transportation
Water Purification

Key Products

Analytical gas generators
Compressed air filters & dryers
Engine air, coolant, fuel & oil filtration systems
Fluid condition monitoring systems
Hydraulic & lubrication filters
Hydrogen, nitrogen & zero air generators
Instrumentation filters
Membrane & fiber filters
Microfiltration
Sterile air filtration
Water desalination & purification filters & systems



Fluid Connectors

Key Markets

Aerial lift
Agriculture
Bulk chemical handling
Construction machinery
Food & beverage
Fuel & gas delivery
Industrial machinery
Life sciences
Marine
Mining
Mobile
Oil & gas
Renewable energy
Transportation

Key Products

Check valves
Connectors for low pressure fluid conveyance
Deep sea umbilicals
Diagnostic equipment
Hose couplings
Industrial hose
Mooring systems & power cables
PTFE hose & tubing
Quick couplings
Rubber & thermoplastic hose
Tube fittings & adapters
Tubing & plastic fittings



Hydraulics

Key Markets

Aerial lift
Agriculture
Alternative energy
Construction machinery
Forestry
Industrial machinery
Machine tools
Marine
Material handling
Mining
Oil & gas
Power generation
Refuse vehicles
Renewable energy
Truck hydraulics
Turf equipment

Key Products

Accumulators
Cartridge valves
Electrohydraulic actuators
Human machine interfaces
Hybrid drives
Hydraulic cylinders
Hydraulic motors & pumps
Hydraulic systems
Hydraulic valves & controls
Hydrostatic steering
Integrated hydraulic circuits
Power take-offs
Power units
Rotary actuators
Sensors



Instrumentation

Key Markets

Alternative fuels
Biopharmaceuticals
Chemical & refining
Food & beverage
Marine & shipbuilding
Medical & dental
Microelectronics
Nuclear Power
Offshore oil exploration
Oil & gas
Pharmaceuticals
Power generation
Pulp & paper
Steel
Water/wastewater

Key Products

Analytical Instruments
Analytical sample conditioning products & systems
Chemical injection fittings & valves
Fluoropolymer chemical delivery fittings, valves & pumps
High purity gas delivery fittings, valves, regulators & digital flow controllers
Industrial mass flow meters/controllers
Permanent no-weld tube fittings
Precision industrial regulators & flow controllers
Process control double block & bleeds
Process control fittings, valves, regulators & manifold valves



Seal

Key Markets

Aerospace
Chemical processing
Consumer
Fluid power
General industrial
Information technology
Life sciences
Microelectronics
Military
Oil & gas
Power generation
Renewable energy
Telecommunications
Transportation

Key Products

Dynamic seals
Elastomeric o-rings
Electro-medical instrument design & assembly
EMI shielding
Extruded & precision-cut, fabricated elastomeric seals
High temperature metal seals
Homogeneous & inserted elastomeric shapes
Medical device fabrication & assembly
Metal & plastic retained composite seals
Shielded optical windows
Silicone tubing & extrusions
Thermal management
Vibration dampening



ENGINEERING YOUR SUCCESS.

> Offer of Sale

The items described in this document and other documents and descriptions provided by Parker Hannifin Corporation, its subsidiaries and its authorized distributors ("Seller") are hereby offered for sale at prices to be established by Seller. This offer and its acceptance by any customer ("Buyer") shall be governed by all of the following Terms and Conditions. Buyer's order for any item described in its document, when communicated to Seller verbally, or in writing, shall constitute acceptance of this offer. All goods or work described are the Parker Transair products provided solely by the Fluid Systems Division of Seller and will be referred to as "Products".

- 1. Terms and Conditions.** Seller's willingness to offer Products, or accept an order for Products, to or from Buyer is expressly conditioned on Buyer's assent to these Terms and Conditions and to the terms and conditions found on-line at www.parker.com/saleterms/. Seller objects to any contrary or additional term or condition of Buyer's order or any other document issued by Buyer.
- 2. Price Adjustments; Payments.** Prices stated on the reverse side or preceding pages of this document are valid for 30 days. After 30 days, Seller may change prices to reflect any increase in its costs resulting from state, federal or local legislation, price increases from its suppliers, or any change in the rate, charge, or classification of any carrier. The prices stated on the reverse or preceding pages of this document do not include any sales, use, or other taxes unless so stated specifically. Unless otherwise specified by Seller, all prices are F.O.B. Seller's facility, and payment is due 30 days from the date of invoice. After 30 days, Buyer shall pay interest on any unpaid invoices at the rate of 1.5% per month or the maximum allowable rate under applicable law.
- 3. Delivery Dates; Title and Risk; Shipment.** All delivery dates are approximate and Seller shall not be responsible for any damages resulting from any delay. Regardless of the manner of shipment, title to any products and risk of loss or damage shall pass to Buyer upon tender to the carrier at Seller's facility (i.e., when it's on the truck, it's yours). Unless otherwise stated, Seller may exercise its judgment in choosing the carrier and means of delivery. No deferral of shipment at Buyer's request beyond the respective dates indicated will be made except on terms that will indemnify, defend and hold Seller harmless against all loss and additional expense. Buyer shall be responsible for any additional shipping charges incurred by Seller due to Buyer's changes in shipping, product specifications or in accordance with Section 13, herein.
- 4. Warranty.** Seller warrants that the Products sold hereunder shall be free from defects in material or workmanship for a period of ten years from the date of shipment to Buyer. This warranty is made only to Buyer and does not extend to anyone to whom Products are sold after purchased from Seller. The prices charged for Seller's products are based upon the exclusive limited warranty stated above, and upon the following disclaimer: **DISCLAIMER OF WARRANTY: THIS WARRANTY COMPRISES THE SOLE AND ENTIRE WARRANTY PERTAINING TO PRODUCTS PROVIDED HEREUNDER. SELLER DISCLAIMS ALL OTHER WARRANTIES, EXPRESS AND IMPLIED, INCLUDING MERCHANTABILITY AND FITNESS FOR A PARTICULAR PURPOSE.**
- 5. Claims; Commencement of Actions.** Buyer shall promptly inspect all Products upon delivery. No claims for shortages will be allowed unless reported to the Seller within 10 days of delivery. No other claims against Seller will be allowed unless asserted in writing within 60 days after delivery or, in the case of an alleged breach of warranty, within 30 days after the date within the warranty period on which the defect is or should have been discovered by Buyer. Any action based upon breach of this agreement or upon any other claim arising out of this sale (other than an action by Seller for any amount due to Seller from Buyer) must be commenced within thirteen months from the date of tender of delivery by Seller or, for a cause of action based upon an alleged breach of warranty, within thirteen months from the date within the warranty period on which the defect is or should have been discovered by Buyer.
- 6. LIMITATION OF LIABILITY.** UPON NOTIFICATION, SELLER WILL, AT ITS OPTION, REPAIR OR REPLACE A DEFECTIVE PRODUCT, OR REFUND THE PURCHASE PRICE. IN NO EVENT SHALL SELLER BE LIABLE TO BUYER FOR ANY SPECIAL, INDIRECT, INCIDENTAL OR CONSEQUENTIAL DAMAGES ARISING OUT OF, OR AS THE RESULT OF, THE SALE, DELIVERY, NON-DELIVERY, SERVICING, USE OR LOSS OF USE OF THE PRODUCTS OR ANY PART THEREOF, OR FOR ANY CHARGES OR EXPENSES OF ANY NATURE INCURRED WITHOUT SELLER'S WRITTEN CONSENT, EVEN IF SELLER HAS BEEN NEGLIGENT, WHETHER IN CONTRACT, TORT OR OTHER LEGAL THEORY. IN NO EVENT SHALL SELLER'S LIABILITY UNDER ANY CLAIM MADE BY BUYER EXCEED THE PURCHASE PRICE OF THE PRODUCTS.
- 7. Contingencies.** Seller shall not be liable for any default or delay in performance if caused by circumstances beyond the reasonable control of Seller.
- 8. User Responsibility.** The user, through its own analysis and testing, is solely responsible for making the final selection of the system and Product and assuring that all performance, endurance, maintenance, safety and warning requirements of the application are met. The user must analyze all aspects of the application and follow applicable industry standards and Product information. If Seller provides Product or system options, the user is responsible for determining that such data and specifications are suitable and sufficient for all applications and reasonably foreseeable uses of the Products or systems.
- 9. Loss to Buyer's Property.** Any designs, tools, patterns, materials, drawings, confidential information or equipment furnished by Buyer or any other items which become Buyer's property, may be considered obsolete and may be destroyed by Seller after two consecutive years have elapsed without Buyer placing an order for the items which are manufactured using such property. Seller shall not be responsible for any loss or damage to such property while it is in Seller's possession or control.
- 10. Special Tooling.** A tooling charge may be imposed for any special tooling, including without limitation, dies, fixtures, molds and patterns, acquired to manufacture Products. Such special tooling shall be and remain Seller's property notwithstanding payment of any charges by Buyer. In no event will Buyer acquire any interest in apparatus belonging to Seller which is utilized in the manufacture of the Products, even if such apparatus has been specially converted or adapted for such manufacture and notwithstanding any charges paid by Buyer. Unless otherwise agreed, Seller shall have the right to alter, discard or otherwise dispose of any special tooling or other property in its sole discretion at any time.
- 11. Buyer's Obligation; Rights of Seller.** To secure payment of all sums due or otherwise, Seller shall retain a security interest in the goods delivered and this agreement shall be deemed a Security Agreement under the Uniform Commercial Code. Buyer authorizes Seller as its attorney to execute and file on Buyer's behalf all documents Seller deems necessary to perfect its security interest. Seller shall have a security interest in, and lien upon, any property of Buyer in Seller's possession as security for the payment of any amounts owed to Seller by Buyer.
- 12. Improper use and Indemnity.** Buyer shall indemnify, defend, and hold Seller harmless from any claim, liability, damages, lawsuits, and costs (including attorney fees), whether for personal injury, property damage, patent, trademark or copyright infringement or any other claim, brought by or incurred by Buyer, Buyer's employees, or any other person, arising out of: (a) improper selection, improper application or other misuse of Products purchased by Buyer from Seller; (b) any act or omission, negligent or otherwise, of Buyer; (c) Seller's use of patterns, plans, drawings, or specifications furnished by Buyer to manufacture Product; or (d) Buyer's failure to comply with these terms and conditions. Seller shall not indemnify Buyer under any circumstance except as otherwise provided.
- 13. Cancellations and Changes.** Orders shall not be subject to cancellation or change by Buyer for any reason, except with Seller's written consent and upon terms that will indemnify, defend and hold Seller harmless against all direct, incidental and consequential loss or damage. Seller may change product features, specifications, designs and availability with notice to Buyer.
- 14. Limitation on Assignment.** Buyer may not assign its rights or obligations under this agreement without the prior written consent of Seller.
- 15. Entire Agreement.** This agreement contains the entire agreement between the Buyer and Seller and constitutes the final, complete and exclusive expression of the terms of the agreement. All prior or contemporaneous written or oral agreements or negotiations with respect to the subject matter are herein merged.
- 16. Waiver and Severability.** Failure to enforce any provision of this agreement will not waive that provision nor will any such failure prejudice Seller's right to enforce that provision in the future. Invalidation of any provision of this agreement by legislation or other rule of law shall not invalidate any other provision herein. The remaining provisions of this agreement will remain in full force and effect.
- 17. Termination.** This agreement may be terminated by Seller for any reason and at any time by giving Buyer thirty (30) days written notice of termination. In addition, Seller may by written notice immediately terminate this agreement for the following: (a) Buyer commits a breach of any provision of this agreement (b) the appointment of a trustee, receiver or custodian for all or any part of Buyer's property (c) the filing of a petition for relief in bankruptcy of the other Party on its own behalf, or by a third party (d) an assignment for the benefit of creditors, or (e) the dissolution or liquidation of the Buyer.
- 18. Governing Law.** This agreement and the sale and delivery of all Products hereunder shall be deemed to have taken place in and shall be governed and construed in accordance with the laws of the State of Ohio, as applicable to contracts executed and wholly performed therein and without regard to conflicts of laws principles. Buyer irrevocably agrees and consents to the exclusive jurisdiction and venue of the courts of Cuyahoga County, Ohio with respect to any dispute, controversy or claim arising out of or relating to this agreement. Disputes between the parties shall not be settled by arbitration unless, after a dispute has arisen, both parties expressly agree in writing to arbitrate the dispute.
- 19. Indemnity for Infringement of Intellectual Property Rights.** Seller shall have no liability for infringement of any patents, trademarks, copyrights, trade dress, trade secrets or similar rights except as provided in this Section. Seller will defend and indemnify Buyer against allegations of infringement of U.S. patents, U.S. trademarks, copyrights, trade dress and trade secrets ("Intellectual Property Rights"). Seller will defend at its expense and will pay the cost of any settlement or damages awarded in an action brought against Buyer based on an allegation that a Product sold pursuant to this Agreement infringes the Intellectual Property Rights of a third party. Seller's obligation to defend and indemnify Buyer is contingent on Buyer notifying Seller within ten (10) days after Buyer becomes aware of such allegations of infringement, and Seller having sole control over the defense of any allegations or actions including all negotiations for settlement or compromise. If a Product is subject to a claim that it infringes the Intellectual Property Rights of a third party, Seller may, at its sole expense and option, procure for Buyer the right to continue using the Product, replace or modify the Product so as to make it noninfringing, or offer to accept return of the Product and return the purchase price less a reasonable allowance for depreciation. Notwithstanding the foregoing, Seller shall have no liability for claims of infringement based on information provided by Buyer, or directed to Products delivered hereunder for which the designs are specified in whole or part by Buyer, or infringements resulting from the modification, combination or use in a system of any Product sold hereunder. The foregoing provisions of this Section shall constitute Seller's sole and exclusive liability and Buyer's sole and exclusive remedy for infringement of Intellectual Property Rights.
- 20. Taxes.** Unless otherwise indicated, all prices and charges are exclusive of excise, sales, use, property, occupational or like taxes which may be imposed by any taxing authority upon the manufacture, sale or delivery of Products.
- 21. Equal Opportunity Clause.** For the performance of government contracts and where dollar value of the Products exceed \$10,000, the equal employment opportunity clauses in Executive Order 11246, VEVRRA, and 41 C.F.R. §§ 60-1.4(a), 60-741.5(a), and 60-250.4, are hereby incorporated.