

Dimensional Documentation

viega

ProPress®

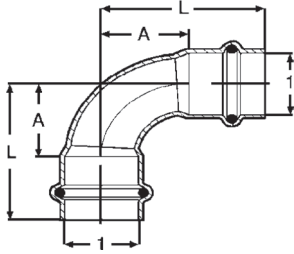

Viega ProPress 90° Elbow Copper P x P - Model 2916

Part No.	Size		A (in)	L (in)
	1	1		
77317	½"	½"	0.75	1.50
77322	¾"	¾"	1.04	1.94
77327	1"	1"	1.32	2.23
77332	1¼"	1¼"	1.65	2.68
77337	1½"	1½"	1.98	3.40
77342	2"	2"	2.54	4.13

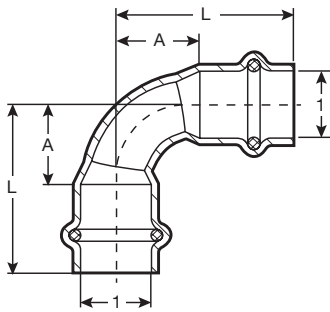

Viega ProPress 90° Elbow Copper P x P - Model 2916 Short

Part No.	Size		A (in)	L (in)
	1	1		
77317	½"	½"	0.75	1.50
77022	¾"	¾"	0.76	1.67
77027	1"	1"	1.28	2.19
77032	1¼"	1¼"	1.28	2.31
77037	1½"	1½"	1.29	2.72
77042	2"	2"	2.16	3.74

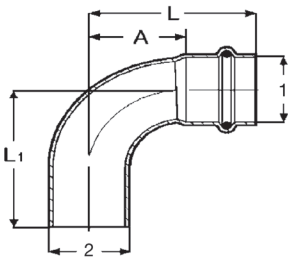

Viega ProPress 90° Street Elbow Copper P x FTG - Model 2916.1

Part No.	Size		A (in)	L (in)	L1 (in)
	1	2			
77347	½"	½"	0.75	1.50	1.54
77352	¾"	¾"	1.04	1.94	1.98
77357	1"	1"	1.32	2.23	2.27
77362	1¼"	1¼"	1.65	2.68	2.76
77367	1½"	1½"	1.98	3.40	3.48
77372	2"	2"	2.54	4.13	4.20

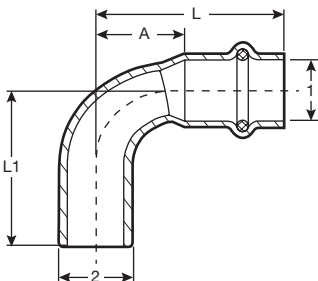

Viega ProPress 90° Street Elbow Copper P x FTG - Model 2916.1 Short

Part No.	Size		A (in)	L (in)	L1 (in)
	1	2			
77347	½"	½"	0.75	1.50	1.54
77052	¾"	¾"	0.76	1.67	1.83
77057	1"	1"	1.28	2.19	2.27
77062	1¼"	1¼"	1.28	2.31	2.48
77067	1½"	1½"	1.29	2.72	2.80
77072	2"	2"	2.16	3.74	3.78

Dimensional Documentation

viega

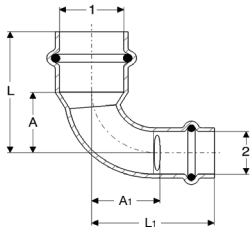

Viega ProPress 90° Reducing Elbow Copper P x P - Model 2916.3

Part No.	Size		A (in)	A1 (in)	L (in)	L1 (in)
	1	2				
77325	3/4" x 1/2"		0.91	0.94	1.81	1.69
77330	1" x 3/4"		1.20	1.30	2.11	2.21

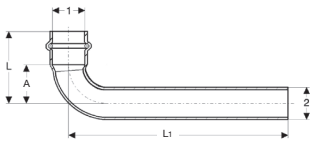

Viega ProPress 90° Extended Street Elbow Copper P x FTG - Model 2947

Part No.	Size		A (in)	L (in)	L1 (in)
	1	2			
77353	3/4" x 3/4"		1.02	1.93	5.98

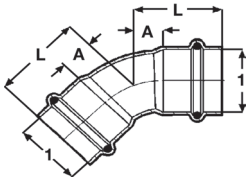

Viega ProPress 45° Elbow Copper P x P - Model 2926

Part No.	Size		A (in)	L (in)
	1	1		
77607	1/2" x 1/2"		0.30	1.04
77612	3/4" x 3/4"		0.43	1.34
77617	1" x 1"		0.55	1.46
77622	1 1/4" x 1 1/4"		0.68	1.71
77627	1 1/2" x 1 1/2"		0.81	2.24
77632	2" x 2"		1.05	2.63

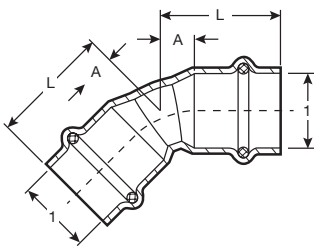

Viega ProPress 45° Elbow Copper P x P - Model 2926 Short

Part No.	Size		A (in)	L (in)
	1	1		
77607	1/2" x 1/2"		0.30	1.04
77023	3/4" x 3/4"		0.36	1.26
77028	1" x 1"		0.47	1.38
77033	1 1/4" x 1 1/4"		0.58	1.61
77038	1 1/2" x 1 1/2"		0.65	2.08
77043	2" x 2"		0.86	2.44

Dimensional Documentation

viega

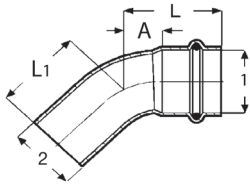

Viega ProPress 45° Street Elbow Copper P x FTG - Model 2926.1

Part No.	Size	A (in)	L (in)	L1 (in)
	1 2			
77637	1/2" x 1/2"	0.31	1.06	1.10
77642	3/4" x 3/4"	0.43	1.34	1.37
77647	1" x 1"	0.55	1.46	1.49
77652	1 1/4" x 1 1/4"	0.68	1.71	1.79
77657	1 1/2" x 1 1/2"	0.81	2.24	2.32
77662	2" x 2"	1.05	2.63	2.71

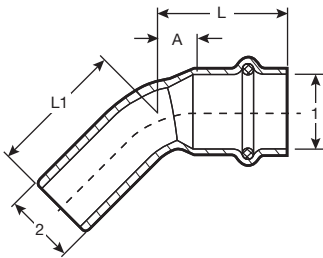

Viega ProPress 45° Street Elbow Copper P x FTG - Model 2926.1 Short

Part No.	Size	A (in)	L (in)	L1 (in)
	1 2			
77637	1/2" x 1/2"	0.31	1.06	1.10
77053	3/4" x 3/4"	0.36	1.26	1.30
77058	1" x 1"	0.47	1.38	1.49
77063	1 1/4" x 1 1/4"	0.58	1.61	1.67
77068	1 1/2" x 1 1/2"	0.65	2.08	2.04
77073	2" x 2"	0.86	2.44	2.54

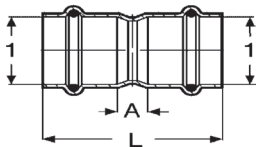

Viega ProPress Coupling with Stop Copper P x P - Model 2915

Part No.	Size	A (in)	L (in)
	1 1		
78047	1/2" x 1/2"	0.12	1.61
78052	3/4" x 3/4"	0.20	2.01
78057	1" x 1"	0.16	1.97
78062	1 1/4" x 1 1/4"	0.14	2.20
78067	1 1/2" x 1 1/2"	0.14	2.99
78072	2" x 2"	0.14	3.31

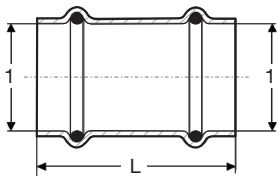

Viega ProPress Coupling No Stop Copper P x P - Model 2915.3

Part No.	Size	L (in)
	1 1	
78172	1/2" x 1/2"	1.61
78177	3/4" x 3/4"	2.01
78182	1" x 1"	1.97
78187	1 1/4" x 1 1/4"	2.20
78192	1 1/2" x 1 1/2"	2.99
78197	2" x 2"	3.31

Dimensional Documentation

viega

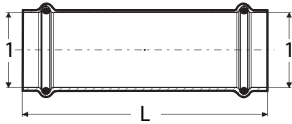

Viega ProPress Extended Coupling Copper P x P - Model 2915.5

Part No.	Size	L (in)
	1 1	
79005	1/2" x 1/2"	2.99
79010	3/4" x 3/4"	3.50
79015	1" x 1"	3.74
79020	1 1/4" x 1 1/4"	4.13
79025	1 1/2" x 1 1/2"	4.72
79030	2" x 2"	5.31

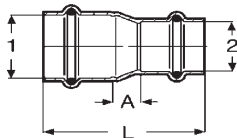

Viega ProPress Reducer Copper P x P - Model 2915.2

Part No.	Size	A (in)	L (in)
	1 2		
78147	3/4" x 1/2"	0.42	2.07
15603	1" x 1/2"	0.71	2.36
78152	1" x 3/4"	0.48	2.29
15593	1 1/4" x 3/4"	0.70	2.64
78157	1 1/4" x 1"	0.55	2.48
18473	1 1/2" x 3/4"	0.98	3.33
15588	1 1/2" x 1"	0.74	3.07
78162	1 1/2" x 1 1/4"	0.50	2.96
18468	2" x 3/4"	1.54	4.02
15608	2" x 1"	1.29	3.78
22328	2" x 1 1/4"	0.81	3.43
78167	2" x 1 1/2"	0.74	3.75

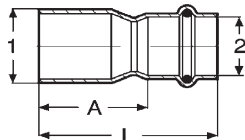

Viega ProPress Reducer Copper FTG x P - Model 2915.1

Part No.	Size	A (in)	L (in)
	1 2		
78077	3/4" x 1/2"	1.42	2.17
78082	1" x 1/2"	1.69	2.44
78087	1" x 3/4"	1.42	2.32
22333	1 1/4" x 1/2"	1.91	2.74
78092	1 1/4" x 3/4"	1.85	2.76
78097	1 1/4" x 1"	1.57	2.48
14543	1 1/2" x 3/4"	2.56	3.46
78102	1 1/2" x 1"	2.28	3.19
78107	1 1/2" x 1 1/4"	2.04	3.07
78112	2" x 1"	3.03	3.94
78117	2" x 1 1/4"	2.79	3.82
78122	2" x 1 1/2"	2.63	4.06

Dimensional Documentation

viega

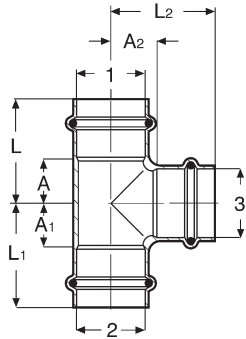

Viega ProPress Tee Copper P x P x P - Model 2918

Part No.	Size			A (in)	A1 (in)	A2 (in)	L (in)	L1 (in)	L2 (in)
	1	2	3						
77377	1/2"	1/2"	1/2"	0.75	0.75	0.50	1.50	1.50	1.25
77382	1/2"	1/2"	3/4"	0.91	0.91	0.59	1.65	1.65	1.50
15493	1/2"	1/2"	1"	1.10	1.10	0.55	1.85	1.85	1.46
77387	3/4"	3/4"	3/4"	0.85	0.85	0.59	1.75	1.75	1.50
77392	3/4"	1/2"	1/2"	0.69	0.98	0.63	1.59	1.73	1.38
77397	3/4"	1/2"	3/4"	0.85	1.14	0.59	1.75	1.89	1.50
77402	3/4"	3/4"	1/2"	0.69	0.69	0.63	1.59	1.59	1.38
77407	3/4"	3/4"	1"	0.97	0.97	0.63	1.87	1.87	1.54
77412	1"	1"	1"	0.97	0.97	0.79	1.87	1.87	1.69
22263	1"	1/2"	3/4"	0.85	1.24	0.75	1.76	1.99	1.66
94767	1"	1/2"	1"	0.97	1.52	0.79	1.87	2.26	1.69
77417	1"	3/4"	1/2"	0.69	0.89	0.79	1.59	1.79	1.54
77422	1"	3/4"	3/4"	0.85	1.04	0.75	1.75	1.95	1.65
77427	1"	3/4"	1"	0.97	1.18	0.78	1.87	2.07	1.69
77432	1"	1"	1/2"	0.69	0.69	0.79	1.59	1.59	1.54
77437	1"	1"	3/4"	0.85	0.85	0.75	1.75	1.75	1.65
15488	1"	1"	1 1/4"	1.16	1.16	0.84	2.07	2.07	1.87
77442	1 1/4"	1 1/4"	1 1/4"	1.02	1.02	0.86	2.05	2.05	1.89
22253	1 1/4"	1/2"	1 1/4"	1.02	1.77	0.87	2.05	2.52	1.89
22243	1 1/4"	3/4"	1/2"	0.64	1.13	0.93	1.68	2.03	1.68
22258	1 1/4"	3/4"	3/4"	0.76	1.30	0.87	1.80	2.21	1.78
22268	1 1/4"	3/4"	1"	0.88	1.40	0.91	1.91	2.31	1.82
22248	1 1/4"	3/4"	1 1/4"	1.02	1.54	0.86	2.05	2.45	1.89
22238	1 1/4"	1"	1/2"	0.64	0.91	0.93	1.68	1.82	1.68
94762	1 1/4"	1"	3/4"	0.76	1.14	0.87	1.79	2.05	1.77
14568	1 1/4"	1"	1"	0.88	1.28	0.91	1.91	2.19	1.81
94757	1 1/4"	1 1/4"	1/2"	0.65	0.65	0.93	1.67	1.67	1.67
77452	1 1/4"	1 1/4"	3/4"	0.77	0.77	0.89	1.79	1.79	1.77
77447	1 1/4"	1 1/4"	1"	0.88	0.88	0.90	1.91	1.91	1.81
77457	1 1/2"	1 1/2"	1 1/2"	1.13	1.13	1.13	2.56	2.56	2.56
79660	1 1/2"	1"	3/4"	0.67	1.39	1.16	2.17	2.44	2.05
15458	1 1/2"	1"	1"	0.74	1.54	1.06	2.17	2.44	1.97
15463	1 1/2"	1"	1 1/2"	1.13	1.83	1.13	2.56	2.74	2.56
22233	1 1/2"	1 1/4"	3/4"	0.67	1.08	1.15	2.09	2.11	2.05
15453	1 1/2"	1 1/4"	1"	0.74	1.29	1.18	2.17	2.32	2.09
15483	1 1/2"	1 1/4"	1 1/4"	0.86	1.33	1.13	2.28	2.36	2.17
15448	1 1/2"	1 1/2"	1/2"	0.47	0.47	1.10	1.89	1.89	1.85
77462	1 1/2"	1 1/2"	3/4"	0.66	0.66	1.14	2.09	2.09	2.05
77467	1 1/2"	1 1/2"	1"	0.74	0.74	1.18	2.17	2.17	2.09
77472	1 1/2"	1 1/2"	1 1/4"	0.86	0.86	1.13	2.28	2.28	2.17
77477	2"	2"	2"	1.37	1.37	1.37	2.95	2.95	2.95
15518	2"	1 1/4"	1 1/4"	0.94	1.84	1.33	2.52	2.87	2.36
15513	2"	1 1/2"	3/4"	0.70	1.25	1.38	2.28	2.68	2.28
15498	2"	1 1/2"	1"	0.82	1.45	1.38	2.40	2.87	2.28
15508	2"	1 1/2"	1 1/4"	0.94	1.55	1.49	2.52	2.97	2.52

Continued on next page

Dimensional Documentation

viega

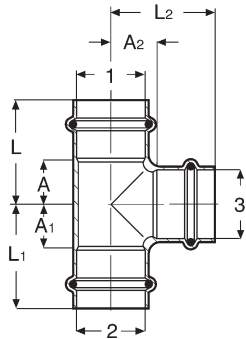

Copper Tee P x P x P - Model 2918 (continued)

Part No.	Size			A (in)	A1 (in)	A2 (in)	L (in)	L1 (in)	L2 (in)
	1	2	3						
15503	2" x 1½" x 1½"			1.13	1.65	1.37	2.72	3.07	2.80
22228	2" x 1½" x 2"			1.38	1.89	1.38	2.95	3.33	2.95
15538	2" x 2" x ½"			0.54	0.54	1.30	2.13	2.13	2.05
94777	2" x 2" x ¾"			0.79	0.79	1.26	2.37	2.37	2.17
94772	2" x 2" x 1"			0.91	0.91	1.30	2.49	2.49	2.21
77487	2" x 2" x 1¼"			1.04	1.04	1.37	2.62	2.62	2.40
77482	2" x 2" x 1½"			1.13	1.13	1.37	2.72	2.72	2.80

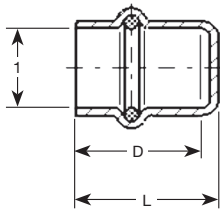

Viega ProPress Cap Copper P - Model 2956

Part No.	Size	L (in)	D (in)
	1		
77712	½"	0.92	0.79
77717	¾"	1.07	0.94
77722	1"	1.11	0.99
77727	1¼"	1.32	1.20
77732	1½"	1.62	1.49
77737	2"	1.81	1.69

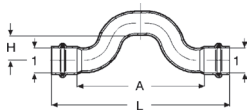

Viega ProPress Cross-Over Copper P x P - Model 2928

Part No.	Size	A (in)	L (in)	H (in)
	1 1			
77742	½" x ½"	3.62	5.12	0.77
77747	¾" x ¾"	4.49	6.30	0.90

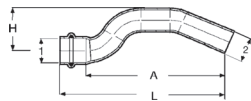

Viega ProPress Cross-Over Copper P x FTG - Model 2927

Part No.	Size	A (in)	L (in)	H (in)
	1 2			
78137	½" x ½"	3.83	4.58	1.10
78142	¾" x ¾"	4.64	5.54	1.54

Dimensional Documentation

viega

Viega ProPress Adapter Zero Lead Bronze P x MPT - Model 2911ZL

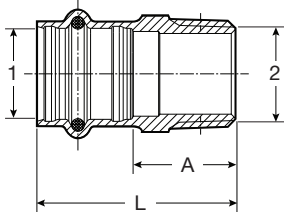

Part No.	Size		A (in)	L (in)
	1	2		
79210	1/2"	3/8" MPT	0.77	1.59
79215	1/2"	1/2" MPT	0.89	1.71
79220	1/2"	3/4" MPT	1.00	1.83
79225	3/4"	1/2" MPT	1.02	1.93
79230	3/4"	3/4" MPT	1.02	1.93
79235	3/4"	1" MPT	1.18	2.09
79240	1"	3/4" MPT	1.18	2.09
79245	1"	1" MPT	1.26	2.17
79250	1"	1 1/4" MPT	1.54	2.44
79255	1 1/4"	1" MPT	1.22	2.24
79260	1 1/4"	1 1/4" MPT	1.34	2.36
79265	1 1/4"	1 1/2" MPT	1.48	2.50
79270	1 1/2"	1 1/4" MPT	1.34	2.76
79275	1 1/2"	1 1/2" MPT	1.28	2.70
79280	1 1/2"	2" MPT	1.65	3.07
79285	2"	1 1/2" MPT	1.54	3.11
79290	2"	2" MPT	1.50	3.07

Viega ProPress Adapter Zero Lead Bronze P x FPT - Model 2912ZL

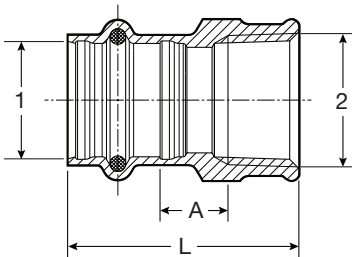

Part No.	Size		A (in)	L (in)
	1	2		
79295	1/2"	3/8" FPT	0.19	1.42
79300	1/2"	1/2" FPT	0.25	1.61
79305	1/2"	3/4" FPT	0.27	1.65
79310	3/4"	1/2" FPT	0.33	1.77
79315	3/4"	3/4" FPT	0.35	1.81
79320	1"	1/2" FPT	0.41	1.85
79325	1"	3/4" FPT	0.39	1.85
79330	1"	1" FPT	0.44	2.01
79335	1"	1 1/4" FPT	0.50	2.09
79340	1 1/4"	1/2" FPT	0.37	1.93
79345	1 1/4"	1" FPT	0.24	1.93
79350	1 1/4"	1 1/4" FPT	0.34	2.05
79355	1 1/4"	1 1/2" FPT	0.42	2.13
79360	1 1/2"	1 1/4" FPT	0.26	2.36
79365	1 1/2"	1 1/2" FPT	0.34	2.44
79370	2"	2" FPT	0.41	2.68

Dimensional Documentation

viega

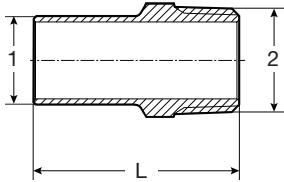

Viega ProPress Adapter Zero Lead Bronze FTG x MPT - Model 2911.1ZL

Part No.	Size		L (in)
	1	2	
79375	1/2"	3/8" MPT	1.75
79380	1/2"	1/2" MPT	1.95
79385	1/2"	3/4" MPT	2.05
79390	3/4"	1/2" MPT	1.93
79395	3/4"	3/4" MPT	2.05
79400	1"	3/4" MPT	2.05
79405	1"	1" MPT	2.22
79410	1 1/4"	1 1/4" MPT	2.54
79415	1 1/2"	1 1/2" MPT	2.89
79420	2"	2" MPT	3.33

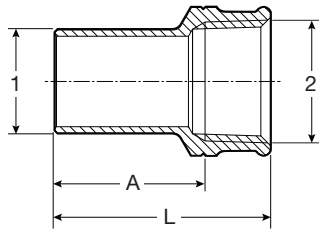

Viega ProPress Adapter Zero Lead Bronze FTG x FPT - Model 2912.1ZL

Part No.	Size		A (in)	L (in)
	1	2		
79425	1/2"	3/8" FPT	1.10	1.54
79430	1/2"	1/2" FPT	1.22	1.75
79435	1/2"	3/4" FPT	1.30	1.83
79440	3/4"	1/2" FPT	1.26	1.79
79445	3/4"	3/4" FPT	1.28	1.83
79455	1"	1/2" FPT	1.35	1.99
79450	1"	1" FPT	1.33	1.99
79460	1 1/4"	1/2" FPT	1.65	2.19
79465	1 1/4"	1 1/4" FPT	1.50	2.19
79470	1 1/2"	1 1/2" FPT	1.88	2.56
79475	2"	2" FPT	2.13	2.95

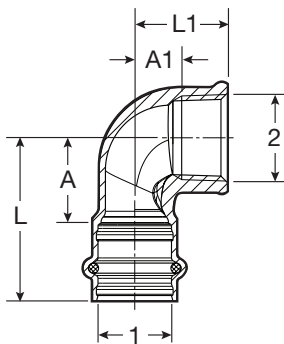

Viega ProPress 90° Elbow Zero Lead Bronze P x FPT - Model 2914.2ZL

Part No.	Size		A (in)	A1 (in)	L (in)	L1 (in)
	1	2				
79520	1/2"	3/8" FPT	0.94	0.42	1.77	0.83
79525	1/2"	1/2" FPT	0.94	0.57	1.77	1.10
79530	1/2"	3/4" FPT	1.06	0.51	1.89	1.06
79535	3/4"	1/2" FPT	1.06	0.65	1.97	1.18
79540	3/4"	3/4" FPT	1.06	0.57	1.97	1.12
79545	1"	1/2" FPT	1.06	0.72	1.97	1.26
79550	1"	1" FPT	1.34	0.76	2.24	1.42
79560	1 1/4"	1 1/4" FPT	1.54	0.89	2.56	1.57
79565	1 1/2"	1 1/2" FPT	1.69	1.05	3.11	1.73
79570	2"	2" FPT	2.17	1.35	3.74	2.05

Dimensional Documentation

viega

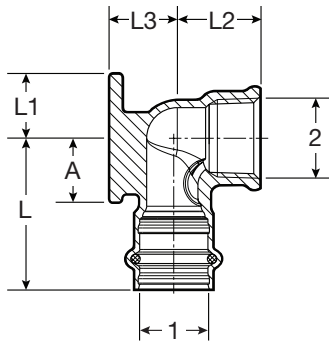

Viega ProPress 90° Drop Ear Elbow Zero Lead Bronze P X FPT - Model 2925.5ZL

Part No.	Size		A (in)	L (in)	L1 (in)	L2 (in)	L3 (in)
	1	2					
79185	1/2"	3/8" FPT	0.94	1.77	0.74	0.83	0.67
79190	1/2"	1/2" FPT	0.94	1.77	0.74	1.10	0.67
79195	3/4"	3/4" FPT	1.06	1.97	0.83	1.12	0.83

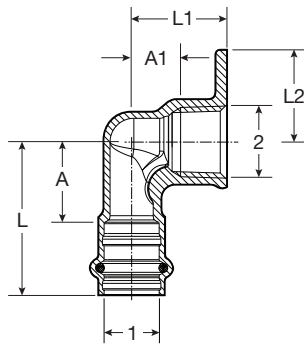

Viega ProPress 90° Hi Ear Elbow Zero Lead Bronze P x FPT - Model 2925.2ZL

Part No.	Size		A (in)	A1 (in)	L (in)	L1 (in)	L2 (in)
	1	2					
79205	1/2"	1/2" FPT	0.94	0.57	1.77	1.10	1.07

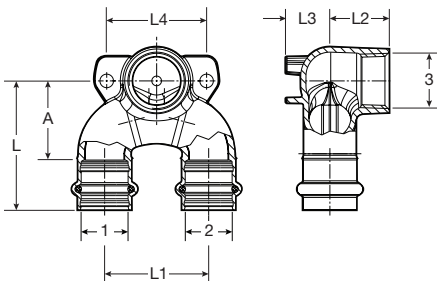

Viega ProPress Double Drop Elbow Zero Lead Bronze P x P x FPT - Model 2928.7ZL

Part No.	Size			A (in)	L (in)	L1 (in)	L2 (in)	L3 (in)	L4 (in)
	1	2	3						
78800	1/2"	1/2" x 1/2"	1/2" FNPT	1.34	2.17	1.97	1.10	0.67	1.57
78802	3/4"	3/4" x 3/4"	1/2" FNPT	1.54	2.44	1.97	1.10	0.83	2.05
78801	3/4"	3/4" x 3/4"	3/4" FNPT	1.54	2.44	1.97	1.12	0.83	1.89
78803	1"	1" x 1"	1/2" FNPT	1.77	2.68	2.36	1.10	0.87	2.52

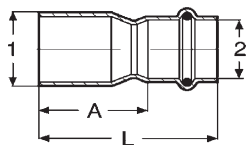

Viega ProPress Reducer Zero Lead Bronze FTG x P - Model 2915.1ZL

Part No.	Size		A (in)	L (in)
	1	2		
79850	1 1/2"	1 1/2"	1.95	2.78
79855	2"	1 1/2"	2.38	3.21
79860	2"	3/4"	2.42	3.33

Dimensional Documentation

viega

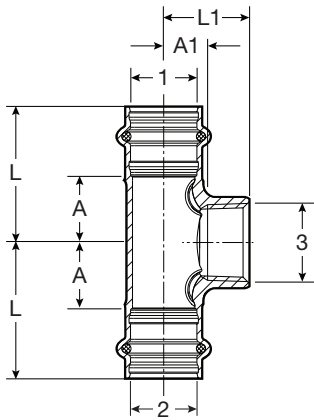

Viega ProPress Tee Zero Lead Bronze P x P x FPT - Model 2917.2ZL

Part No.	Size			A (in)	A1 (in)	L (in)	L1 (in)
	1	2	3				
79580	1/2"	1/2"	1/2" FPT	0.79	0.69	1.61	1.30
79585	3/4"	3/4"	1/4" FPT	0.67	0.79	1.57	1.18
79590	3/4"	3/4"	1/2" FPT	0.79	0.88	1.69	1.42
79595	3/4"	3/4"	3/4" FPT	0.91	0.59	1.81	1.14
79760	1"	1"	1/2" FPT	0.79	1.04	1.69	1.57
79765	1"	1"	3/4" FPT	0.91	1.06	1.81	1.61
79770	1 1/4"	1 1/4"	1/2" FPT	0.83	1.16	1.85	1.69
79775	1 1/4"	1 1/4"	3/4" FPT	0.95	1.18	1.97	1.73
79780	1 1/2"	1 1/2"	1/2" FPT	0.87	1.24	2.28	1.77
79785	1 1/2"	1 1/2"	3/4" FPT	0.94	1.30	2.36	1.85
79790	2"	2"	1/2" FPT	0.98	1.59	2.56	2.13
79795	2"	2"	3/4" FPT	1.06	1.65	2.64	2.20

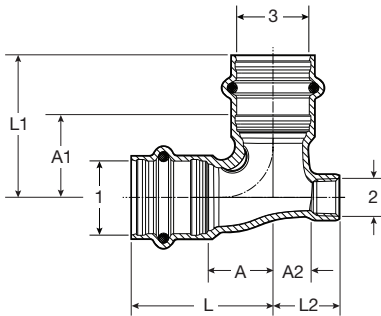

Viega ProPress Vent Tee Zero Lead Bronze P x FPT x P - Model 2917.3ZL

Part No.	Size			A (in)	A1 (in)	A2 (in)	L (in)	L1 (in)	L2 (in)
	1	2	3						
79635	1/2"	1/8" FPT	1/2"	0.67	0.67	0.44	1.50	1.50	0.71
79640	3/4"	1/8" FPT	3/4"	0.83	0.83	0.54	1.73	1.73	0.81

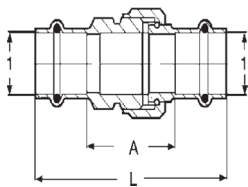

Viega ProPress Union Zero Lead Bronze P x P - Model 2960ZL

Part No.	Size		A (in)	L (in)
	1			
79125	1/2"		1.19	2.84
79130	3/4"		1.34	3.15
79135	1"		1.83	3.65
79140	1 1/4"		1.64	3.69
79145	1 1/2"		2.13	4.96
79150	2"		2.07	5.22

Dimensional Documentation

viega

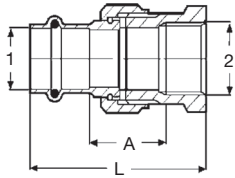

Viega ProPress Union Zero Lead Bronze P x FPT - Model 2962ZL

Part No.	Size		A (in)	L (in)
	1	2		
79700	1/2"	1/2" FPT	0.91	2.27
79705	3/4"	3/4" FPT	0.96	2.42
79710	1"	1" FPT	1.31	2.88
79715	1 1/4"	1 1/4" FPT	1.27	2.97
79720	1 1/2"	1 1/2" FPT	1.77	3.87
79725	2"	2" FPT	1.65	3.92

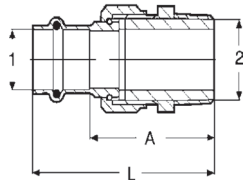

Viega ProPress Union Zero Lead Bronze P x MPT - Model 2965ZL

Part No.	Size		A (in)	L (in)
	1	2		
79730	1/2"	1/2" MPT	1.86	2.69
79735	3/4"	3/4" MPT	2.00	2.90
79740	1"	1" MPT	2.54	3.45
79745	1 1/4"	1 1/4" MPT	2.49	3.52
79750	1 1/2"	1 1/2" MPT	3.05	4.47
79755	2"	2" MPT	2.99	4.57

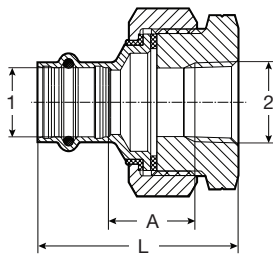

Viega ProPress Dielectric Union Zero Lead Bronze P x FPT - Model 2967ZL

Part No.	Size		A (in)	L (in)
	1	2		
79155	1/2"	1/2" FPT	0.88	2.24
79160	3/4"	3/4" FPT	1.11	2.57
79165	1"	1" FPT	1.00	2.57
79170	1 1/4"	1 1/4" FPT	0.97	2.68
79175	1 1/2"	1 1/2" FPT	1.01	3.11
79180	2"	2" FPT	1.26	3.53

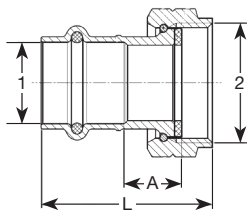

Viega ProPress Tailpiece Zero Lead Bronze P x F BSP - Model 2957ZL

Part No.	Size		A (in)	L (in)
	1	2		
79800	1/2"	1" BSP	0.39	1.57
79805	3/4"	1" BSP	0.63	1.87
79810	1"	1" BSP	0.91	2.14
79815	1"	1 1/4" BSP	0.73	2.04

Dimensional Documentation

viega

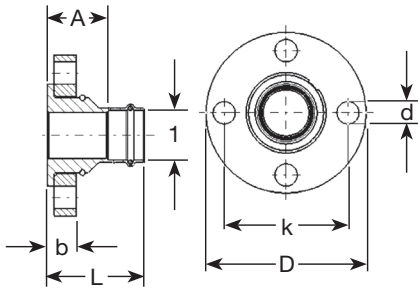

Viega ProPress Adapter Flange Zero Lead Bronze P x Flange - Model 2959.5ZL

Part No.	Size	L (in)	A (in)	b (in)	D (in)	k (in)	d (in)
	1						
79680	1"	2.76	1.85	0.84	4.33	3.11	0.63
79685	1¼"	2.76	1.73	0.84	4.53	3.50	0.63
79690	1½"	3.07	1.65	0.84	4.92	3.86	0.63
79695	2"	3.66	2.09	0.84	5.91	4.76	0.75

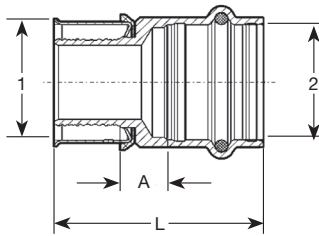

Viega PEX Press Adapter Zero Lead Bronze P x P - Model 2813PZL

Part No.	Size	A (in)	L (in)
	1 2		
99620	½" x ½"	0.29	1.61
99626	½" x ¾"	0.43	1.83
99630	¾" x ½"	0.23	1.56
99640	¾" x ¾"	0.33	1.73
99660	1" x 1"	0.45	1.97
99670	1¼" x 1¼"	0.49	2.38
99680	1½" x 1½"	0.59	2.87
99690	2" x 2"	0.58	3.21

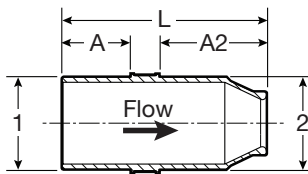

Viega ProPress Venturi Insert Zero Lead Bronze - Model 2911.5ZL

Part No.	Size	A (in)	A2 (in)	L (in)
	1 2			
78810	1¼" x 1¼"	1.02	1.60	3.07
78811	1½" x 1½"	1.43	2.10	3.98
78812	2" x 2"	1.58	2.45	4.48

Viega products are designed to be installed by licensed and trained plumbing and mechanical professionals who are familiar with Viega products and their installation. **Installation by non-professionals may void Viega LLC's warranty.**

This document subject to updates. For the most current Viega technical literature please visit www.viega.us.

Viega LLC, 12303 Airport Way, Ste. 395 • Broomfield, CO 80021 • Ph: 800-976-9819 • Fax: 800-976-9817