



SAMMYS[®]



2014 Product Catalog

TABLE OF CONTENTS

Sammys® for Wood	4
Sidewinder® for Wood.....	5
Sammys Swivel Head™ for Wood	5
Sammys® for Steel.....	6
Sidewinder® for Steel	7
Sammys Swivel Head™ for Steel	7
Sammy X-Press®	8
Sammy X-Press Sidewinder™	8
Sammy X-Press Swivel™	9
Sammy X-Press It® Installation Tool	9
Sammys® for Concrete	10
Sidewinder® for Concrete	10
Sammys Swivel Head™ for Concrete.....	11
Concrete/Wood Installation Kit	11
Sammys Toggle™	12
Ceiling Screws.....	12
Dektite® Pipe Flashing	13
Speedy Pole Tool™	13
Approvals and Listings	14
Special Notes	15

Warranty • Disclaimer of Warranty

Proper fastener connection design takes in to account where and how fasteners are used. Allowance for special characteristics in materials, differences in materials, differences in types of materials being joined, unique or unusual environmental service or installation conditions and the safety factors required by anticipating normal or short term loading conditions must be considered. Due to possible differences in specifications, applications, and interpretation of results, purchasers and specifiers must make their own evaluation of the products, to determine the suitability of these products for intended use. All warranties of Buildex products, expressed or implied, including the warranties of merchantability and fitness for particular purposes are specifically excluded except for the following: Buildex will repair or replace any product which, within twelve months after sale by Buildex or its distributors, is found by Buildex to be defective in material or workmanship - normal wear and tear accepted. This is the sole warranty of Buildex and the sole remedy available to distributor or buyer. Buildex shall not be liable for any injury, loss or damage, direct, indirect, or consequential, arising out of the use of, or the inability to use, any Buildex product.

INSTALLATION INSTRUCTIONS FOR WOOD & STEEL

INSTALLATION STEPS - VERTICAL INTO WOOD & STEEL:

1. Insert the appropriate nut driver into a 3/8" or 1/2" portable drill.
2. Insert the SAMMYS® into the #14 (black) nut driver (p/n 8113910). Drill should be in a vertical position.
3. Push the face of the nut driver tight to the member. Begin installation when the nut driver spins freely on the SAMMYS, stop drill and remove.
4. The SAMMYS is now ready to receive 1/4", 3/8", 1/2" or metric all thread rod, bolt stock. (The 1/2" requires the #14SW red nut driver)

Note: When installing DSTR, follow the above instructions, then add retainer nut and torque to 20 foot lbs. for maximum pullout in purlin steel.

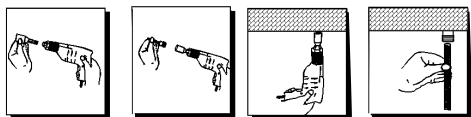

INSTALLATION STEPS - HORIZONTAL INTO WOOD & STEEL:

1. Insert the appropriate nut driver into a 3/8" or 1/2" portable drill.
2. Insert the SAMMYS into the #14SW (red) nut driver (p/n 8114910). With drill unit in a horizontal position and at a right angle to the structural member, begin installation.
3. When the nut driver spins freely on the SAMMYS, stop the drill and remove.
4. The unit is now ready to receive 1/4", 3/8", M10, M8 or metric all thread rod or bolt stock.

Note: When installing SWDR, follow the above instructions, then add retainer nut and torque to 20 foot lbs. for maximum pullout in purlin steel.

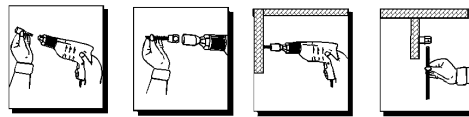

INSTALLATION INSTRUCTIONS FOR CONCRETE

INSTALLATION STEPS - VERTICAL INTO CONCRETE:

1. Using an SDS 250 carbide tip bit or a HEX RECEIVER with a #250 carbide tip bit, pre-drill the concrete member to a depth of 2" with a hammer/rotary hammer drill set on impact mode.
2. After pre-drilling has been completed, install the SLEEVE TOOL over the bit (the bit should remain in the drill), and insert the #14 (black) nut driver (p/n 8113910) into the opposite end (see Vertical Installation note above).
3. Insert the CST screw into the nut driver.
4. Place tip of screw into the pre-drilled hole, turn impact/drill unit to drill mode and begin insertion. When the nut driver spins freely on the CST screw, installation is complete. Stop and remove drill.
5. The concrete screw is ready to receive 1/4", 3/8", 1/2", or metric all thread rod or bolt stock. (#14SW red nut driver used with 1/2" screw)

Note: Use a 1200 maximum RPM drill for installation.

Note: Do not install concrete screws while the drill unit is in impact mode — doing so will destroy the pullout factor of the screw.

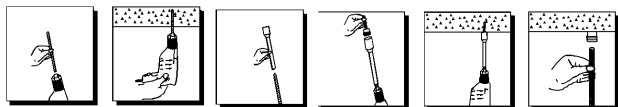

INSTALLATION STEPS - HORIZONTAL INTO CONCRETE:

1. Using an SDS 250 carbide tip bit or a HEX RECEIVER with a #250 carbide tip bit, pre-drill the concrete member to a depth of 2" with a hammer/rotary hammer drill set on impact mode.
2. After pre-drilling has been completed, install the SLEEVE TOOL over the bit (the bit should remain in the drill), and insert the #14SW (red) nut driver (p/n 8114910) into the opposite end.
3. Insert the SWC screw into the nut driver.
4. Place tip of screw into the pre-drilled hole, turn impact/drill unit to drill mode and begin insertion. When the nut driver spins free on the SWC screw, installation is complete. Stop and remove drill.
5. The SWC screw is ready to receive 1/4", 3/8" or metric all thread rod or bolt stock.

Note: Use a 1200 maximum RPM drill for installation.

Note: Do not install concrete screws while the drill unit is in impact mode — doing so will destroy the pullout factor of the fastener.

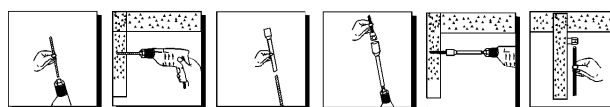

SPECIAL NUT DRIVER SYSTEM: The nut drivers were designed with a unique spin-off feature which provides a fast and safe installation each time. When the face of the driver comes into contact with the material you are installing into, continue drilling until nut driver spins free. Installation is then complete. Warranty requires the use of the appropriate nut driver for installations.

SAMMYS® FOR WOOD - Vertical Application



Application

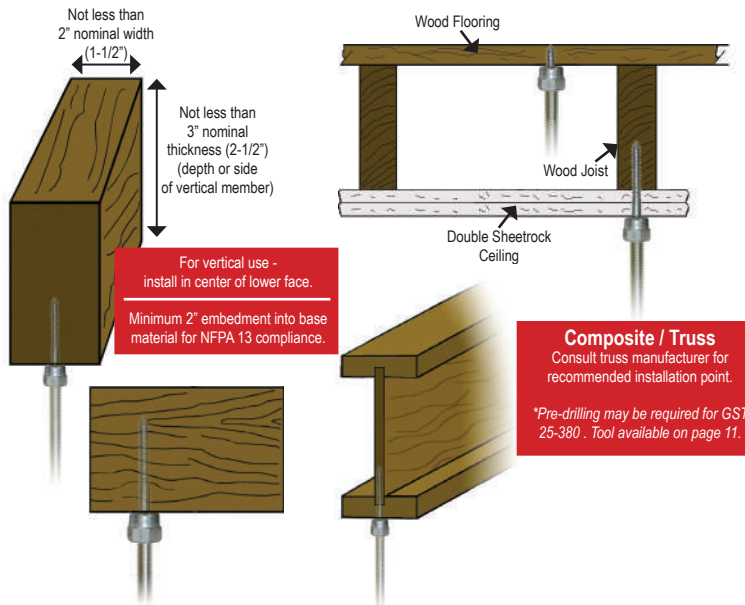

Product Features

- No pre-drilling required.
- Quick to install using the Sammy Nut Driver with an 18V cordless drill/driver.
- Saves time from traditional methods.
- Reduces installation costs.
- Manufactured in the U.S.A.



Approvals	Rod Size	Part Number	Model	Screw Descriptions	Ultimate Pullout (lbs)	UL Test Load (lbs)	FM Test Load (lbs)	Box Qty	Case Qty
VERTICAL MOUNT									
	1/4"	8002957	GST 100	1/4 x 1"	210 (7/16" OSB) 670 (3/4" Ply)			25	125
	1/4"	8003957	GST 200	1/4 x 2"	1760 (Fir)			25	125
	3/8"	8007957	GST 10	1/4 x 1"	210 (7/16" OSB) 670 (3/4" Ply)	300		25	125
	3/8"	8008957	GST 20	1/4 x 2"	1760 (Fir)	850	1475	25	125
	3/8"	8068925	GST 20-SS	1/4 x 2"	1760 (Fir)	850		25	125
	3/8"	8009925	GST 25-380	3/8 x 2-1/2"	2113 (Fir)	1500		25	125
	3/8"	8010957	GST 30	1/4 x 3"	2060 (Fir)	1500	1475	25	125
	3/8"	8069925	GST 30-SS	1/4 x 3"	2060 (Fir)			25	125
	1/2"	8013925	GST 2	1/4 x 2"	1760 (Fir)			25	125
	1/2"	8015925	GST 3	1/4 x 3"	2275 (Fir)			25	125



#14 Black Nut Driver
Part # 8113910



#14 SW Red Nut Driver
Part # 8114910



SPECIAL NUT DRIVER SYSTEM: The nut drivers were designed with a unique spin-off feature which provides a fast and safe installation each time. When the face of the driver comes into contact with the material you are installing into, continue drilling until nut driver spins free. Installation is then complete. Warranty requires the use of the appropriate nut driver for installations.

SIDEWINDER® FOR WOOD - Horizontal Application

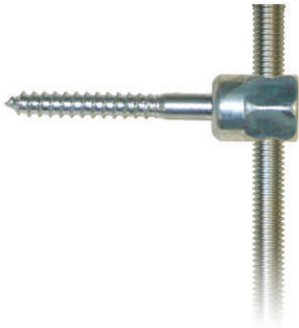

Application

Not less than 2" nominal width (1-1/2" up to 3-1/2" pipe; not less than 3" (2-1/2") nominal width 4" & 5" pipe

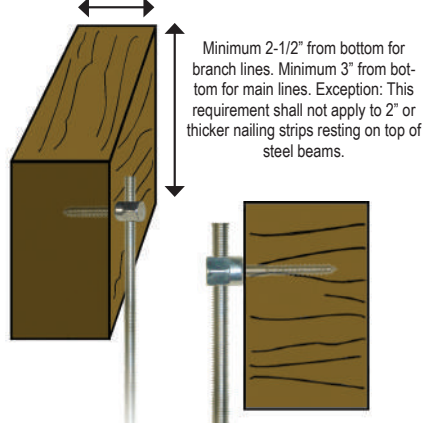

Floor Joist

Product Features

- No pre-drilling required.
- Quick to install using the Sammy Nut Driver with an 18V cordless drill/driver.
- Saves time from traditional methods.
- Reduces installation costs.
- Manufactured in the U.S.A.

Composite / Truss

Consult truss manufacturer for recommended installation point.

*Pre-drilling may be required for Model SWG 25-380. Tool available on page 11.

Watch a video demonstration at www.itwbuildex.com



#14 SW Red Nut Driver Part # 8114910

Approvals	Rod Size	Part Number	Model	Screw Descriptions	Ultimate Pullout (lbs)	UL Test Load (lbs)	Box Qty	Case Qty
HORIZONTAL MOUNT								
	1/4"	8019957	SWG 200	1/4 x 2"	1725 (Fir)		25	125
	3/8"	8020957	SWG 10	1/4 x 1"	622 (Fir)	300	25	125
	3/8"	8021957	SWG 20	1/4 x 2"	1725 (Fir)	1050	25	125
	3/8"	8073925	SWG 20-SS	1/4 x 2"	1725 (Fir)	850	25	125
	3/8**	8022925	SWG 25-380	3/8 x 2-1/2"	2249 (Fir)	1500	25	125
	3/8"	8023925	SWG 30	1/4 x 3"	1884 (Fir)		25	125

* May require pre-drilling; consult joist manufacturer.

SAMMYS SWIVEL HEAD™ FOR WOOD - Swivel Application



#14 Black Nut Driver Part # 8113910



#14 SH Orange Nut Driver Part # 8273910

Application

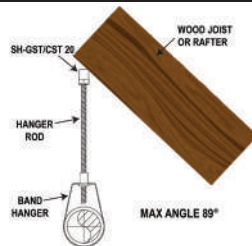

Product Features

- Eliminates distortion of threaded rod.
- Accommodates up to 3 1/2" x 12 pitch roof.
- Allows 17° deflection from vertical.
- Saves time from traditional methods.
- Reduces installation costs.
- Manufactured in the U.S.A.

Approvals	Rod Size	Part Number	Model	Screw Descriptions	Ultimate Pullout (lbs)	UL Test Load (lbs)	FM Test Load (lbs)	Min Thickness	Box Qty	Case Qty
SWIVEL MOUNT										
	3/8"	8139957	SH-GST 20	1/4 x 2"	1257 (Fir)	1050	1475		25	125
	3/8**	8269957	SH-GST/CST 20	5/16 x 1-3/4"	1903 Dim. Lumber 1406 @ 45° off vertical Dim. Lumber	1500 850 @ 45°			25	125
	1/2"	8303957	SH-GST/CST 2.0	5/16 x 1-3/4"	903 Dim. Lumber 1406 @ 45° off vertical Dim. Lumber				25	125

* May require pre-drilling; consult joist manufacturer.

SAMMYS® FOR STEEL

SAMMYS® FOR STEEL - Vertical Application



Application

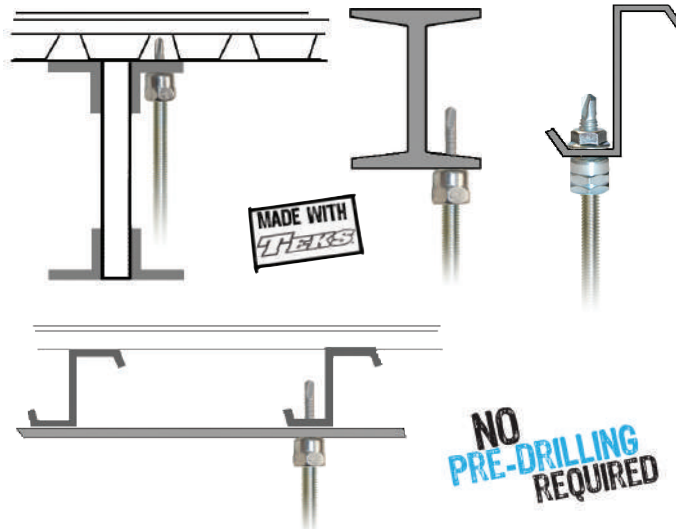

Product Features

- Made with Tek's® self-drilling fasteners - no pre-drilling required.
- Installs into steel range from 20 gauge - 1/2" thicknesses.
- Saves time from traditional methods.
- Reduces installation costs.
- Quick to install using the Sammys Nut Driver with an 18V cordless drill/driver.
- A standard screwgun with a depth sensitive nosepiece should be used to install Tek's. For optimal fastener performance, the screwgun should be a minimum of 6 amps and have an RPM range of 0-2500.
- Manufactured in the U.S.A.

Watch a video demonstration at www.itwbuildex.com

Approvals	Rod Size	Part Number	Model	Screw Descriptions	Ultimate Pullout (lbs)	UL Test Load (lbs)	FM Test Load (lbs)	Min Thick	Max Thick	Box Qty	Case Qty
VERTICAL MOUNT											
	1/4"	8024957	DSTR 100 *	1/4-20 x 1" TEKS 3	1510 (20 ga.)			.036"-20 ga	3/16"	25	125
	1/4"	8025957	DST 100	1/4-14 x 1" TEKS 3	446 (20 ga.)			.036"-20 ga	3/16"	25	125
	1/4"	8026957	DST 150	1/4-14 x 1-1/2" TEKS 3	970 (16 ga.)			.036"-20 ga	3/16"	25	125
	1/4"	8027957	DST 200	1/4-14 x 2" TEKS 3	446 (20 ga.)			.036"-20 ga	3/16"	25	125
	1/4"	8030957	TEK 500	12-24 x 1-1/2" TEKS 5	3125 (3/16")			.188"-3/16"	1/2"	25	125
	3/8"	8038957	DSTR 1 *	1/4-20 x 1" TEKS 3	1510 (20 ga.)	1500	1475	.036"-20 ga	3/16"	25	125
	3/8"	8037957	DSTR 1-1/2 *	12-24 x 1-1/2" TEKS 5	1510 (3/16")	1500	1475	.060"-16 ga.	1/2"	25	125
	3/8"	8039957	DSTR 516 *	5/16-18 x 1-1/4" TEKS 3	2200 (20 ga.)	1500	1475	.036"-20 ga	3/16"	25	125
	3/8"	8040957	DST 10	1/4-14 x 1" TEKS 3	446 (20 ga.) 970 (16 ga.)			.036"-20 ga	3/16"	25	125
	3/8"	8077925	DST 10-SS	1/4-14 x 1" TEKS 3	446 (20 ga.) 970 (16 ga.)			.036"-20 ga	3/16"	25	125
	3/8"	8041957	DST 15	1/4-14 x 1-1/2" TEKS 3	446 (20 ga.) 970 (16 ga.)			.036"-20 ga	3/16"	25	125
	3/8"	8078925	DST 15-SS	1/4-14 x 1-1/2" TEKS 3	446 (20 ga.) 970 (16 ga.)			.036"-20 ga	3/16"	25	125
	3/8"	8042957	DST 20	1/4-14 x 2" TEKS 3	446 (20 ga.) 970 (16 ga.)			.036"-20 ga	3/16"	25	125
	3/8"	8044957	DST 30	1/4-14 x 3" TEKS 3	446 (20 ga.) 970 (16 ga.)			.036"-20 ga	3/16"	25	125
	3/8"	8045957	DST 516	5/16-18 x 1-1/4" TEKS 3	1500 (3/16")	1500	1475	.125"-1/8"	3/16"	25	125
	3/8"	8046957	TEK 50	12-24 x 1-1/2" TEKS 5	3125 (3/16")	1500	1475	.250"-1/4"	1/2"	25	125
	1/2"	8031925	DST 2.0	1/4-14 x 2" TEKS 3	446 (20 ga.) 970 (16 ga.)			.188"-3/16"	1/4"	25	125
	1/2"	8033925	DSTR 1.0 *	1/4-20 x 1" TEKS 3	1510 (20 ga.)			.036"-20 ga	3/16"	25	125
	1/2"	8034925	DSTR 5.16 *	5/16-18 x 1-1/4" TEKS 3	2220 (20 ga.)			.036"-20 ga	3/16"	25	125
	1/2"	8035925	DST 5.16	5/16-18 x 1-1/4" TEKS 3	1500 (3/16")			.125"-1/8"	3/16"	25	125
	1/2"	8036925	TEK 5.0	12-24 x 1-1/2" TEKS 5	3125 (3/16")			.188"-3/16"	1/2"	25	125



#14 Black Nut Driver
Part # 8113910



#14 SW Red Nut Driver
Part # 8114910

*Includes retaining nut



SPECIAL NUT DRIVER SYSTEM: The nut drivers were designed with a unique spin-off feature which provides a fast and safe installation each time. When the face of the driver comes into contact with the material you are installing into, continue drilling until nut driver spins free. Installation is then complete. Warranty requires the use of the appropriate nut driver for installations.

SIDEWINDER® FOR STEEL - Horizontal Application



Application	Product Features
<p>NO PRE-DRILLING REQUIRED</p>	<ul style="list-style-type: none"> Made with TekS® self-drilling fasteners - no pre-drilling required. Installs into steel range from 20 gauge – 1/2" thicknesses. A standard screwgun with a depth sensitive nosepiece should be used to install TekS. For optimal fastener performance, the screwgun should be a minimum of 6 amps and have an RPM range of 0-2500. Saves time from traditional methods. Reduces installation costs. Quick to install using the Sammys Nut Driver with an 18V cordless drill/driver. Manufactured in the U.S.A.

Watch a video demonstration at www.itwbuildex.com



Approvals	Rod Size	Part Number	Model	Screw Descriptions	Ultimate Pullout (lbs)	UL Test Load (lbs)	FM Test Load (lbs)	Min Thickness	Max Thickness	Box Qty	Case Qty
HORIZONTAL MOUNT											
	1/4"	8047957	SWD 100	1/4-14 x 1" TEKS 3	1477 (16 ga.)			.060"-16 ga	3/16"	25	125
	1/4"	8049957	SWDR 100 *	1/4-20 x 1" TEKS 3	1900 (20 ga.)			.036"-20 ga	3/16"	25	125
	3/8"	8050957	SWD 10	1/4-14 x 1" TEKS 3	1477 (16 ga.)			.060"-16 ga	3/16"	25	125
	3/8"	8080925	SWD 10-SS	1/4-14 x 1" TEKS 3	1477 (16 ga.)			.060"-16 ga	3/16"	25	125
	3/8"	8052957	SWD 20	1/4-14 x 2" TEKS 3	1477 (16 ga.)			.060"-16 ga	3/16"	25	125
	3/8"	8055957	SWDR 1 *	1/4-20 x 1" TEKS 3	1900 (20 ga.)	1500	1475	.036"-20 ga	3/16"	25	125
	3/8"	8054957	SWDR 1-1/2 *	12-24 x 1-1/2" TEKS 5	2375 (3/16")	1500	1475	.188"-3/16"	1/2"	25	125
	3/8"	8056957	SWDR 516 *	5/16-18 x 1-1/4" TEKS 3	2480 (20 ga.)	1500	1475	.036"-20 ga	3/16"	25	125
	3/8"	8057957	SWT 15	12-24 x 1-1/2" TEKS 5	2375 (3/16")			.188"-3/16"	1/2"	25	125

*Includes retaining nut

SAMMYS SWIVEL HEAD™ FOR STEEL - Swivel Application



Application	Product Features
	<ul style="list-style-type: none"> Eliminates distortion of threaded rod in sloped roof applications. Accommodates 3-1/2 x 12 pitch. Installs into angled z-purlin; allows threaded rod to hang plumb. Allows 17° deflection from vertical. Manufactured in the U.S.A.

Watch a video demonstration at www.itwbuildex.com



Approvals	Rod Size	Part Number	Model	Screw Descriptions	Ultimate Pullout (lbs)	UL Test Load (lbs)	FM Test Load (lbs)	Min Thick	Max Thick	Box Qty	Case Qty
SWIVEL MOUNT											
	3/8"	8137957	SH-DSTR 1*	1/4-20 X 1" TEKS 3	3220 (3/16")	1500	1475	.035"	3/16"	25	125
	3/8"	8268957	SH-TEK 50	12-24 x 1-3/4" TEKS 5	2368 (1/2" steel Vertical) 1306 (45° off Vertical) 2281 (3/16" HSS) 1585 (3/16" HSS 45° off Vertical)	1500 (Vertical) 850 (45° off Vertical)	4" 2-1/2"	3/16"	1/2"	25	125
	1/2"	8270957	SH-TEK 5.0	12-24 x 1-3/4" TEKS 5	2368 (1/2" steel Vertical) 1306 (45° off Vertical) 2281 (3/16" HSS) 1585 (3/16" HSS 45° off Vertical)			3/16"	1/2"	25	125

*Does not comply with ROHS requirements / Includes retaining nut

SAMMY X-PRESS® - Vertical Application



Application

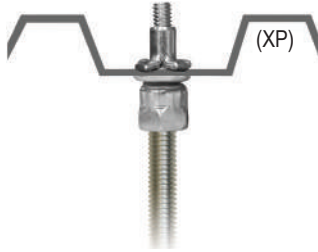

Product Features

- The **Sammy X-Press** expands to provide direct vertical attachment in:
 - light gauge steel deck or purlin (22 ga. - 1/8").
- Installs in seconds with Sammy X-Press It® Tool, saving time & installation costs.
- Use in applications where access to the back of the installed fastener is prohibited, i.e. metal roof deck, tubular steel, or vapor barrier fabric.
- Less jobsite material needed.
- No retaining nut required.
- Provides design flexibility.
- Manufactured in the U.S.A.



Approvals	Rod Size	Part Number	Model	Description	Ultimate Pullout (lbs)	UL Test Load (lbs)	UL Min Thick	FM Test Load (lbs)	FM Min Thick	Max Thick	Box Qty	Case Qty	Application
VERTICAL MOUNT													
UL	1/4"	8181922	XP 200	Sammy X-Press 200	1146 (22 ga)	185 (Luminaire) 250 (Luminaire)	.027" .056"			.125"	25	125	Metal Deck
UL, FM	3/8"	8150922	XP 20	Sammy X-Press 20	1146 (22 ga)	850 (2 1/2" Pipe) 185 (Luminaire) 250 (Luminaire) 283 (Conduit & Cable)	.027" .027" .056" .029"	940 (2" Pipe) 1475 (4" Pipe)	.029" .104"	.125"	25	125	Metal Deck
UL, FM	3/8"	8153922	XP 35	Sammy X-Press 35	1783 (16 ga)	1500 (4" Pipe) 185 (Luminaire) 250 (Luminaire) 416 (Conduit & Cable)	.060" .029" .056" .059"	940 (2" Pipe) 1475 (4" Pipe)	.029" .104"	.125"	25	125	Purlin
UL	3/8"	8150922	XP 20	Sammy X-Press 20	1146 (22 ga)	850 (2 1/2" Pipe)		Pre-Pour Structural Concrete @ 3000 psi			25	125	Metal Deck (Pre-Pour) Metal Deck (Post-Pour)
								Post-Pour Range II LWC ≤ 35 PCF (lbs/ft³)					

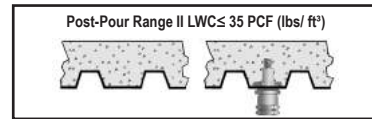
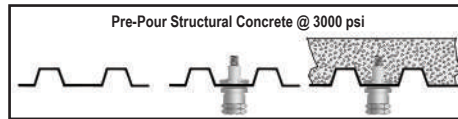
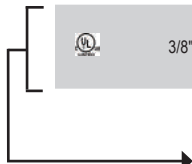

SAMMY X-PRESS SIDEWINDER™ - Horizontal Application



Application



Product Features

- The **Sammy X-Press Sidewinder** expands to provide horizontal attachment in:
 - 16 ga - 3/16" steel - purlin, tubular steel.
- Installs in seconds with Sammy X-Press It® Tool, saving time & installation costs.
- Use in applications where access to the back of the installed fastener is prohibited; i.e. metal roof deck, tubular steel, or vapor barrier fabric.
- Less jobsite material needed.
- No retaining nut required.
- Provides design flexibility.
- Manufactured in the U.S.A.



Approvals	Rod Size	Part Number	Model	Description	Ultimate Pullout (lbs)	UL Test Load (lbs)	UL Min Thick	FM Test Load (lbs)	Max Thick	Box Qty	Case Qty	Application
HORIZONTAL MOUNT												
UL	3/8"	8293957	SWXP 35	Sidewinder X-Press 35	1798 (16 ga)	1250 (3 1/2" Pipe) 80 (Luminaire) 416 (Conduit & Cable)	.059"		.125"	25	125	Purlin



SAMMY X-PRESS SWIVEL™ - Swivel Application



Application	Product Features
<p>FOR EXTREME OR VARIANT ROOF PITCHES</p>	<ul style="list-style-type: none"> The Sammy X-Press Swivel allows you to hang plumb in extreme roof pitches: <ul style="list-style-type: none"> - 89° in z-purlin - 45° in metal deck for 12/12 pitch Installs in seconds with Sammy X-Press It® Tool, saving time & installation costs. Use in applications where access to the back of the installed fastener is prohibited. ie. metal roof deck, tubular steel, or vapor barrier fabric.
	<ul style="list-style-type: none"> Less jobsite material needed. No retaining nut required. Provides design flexibility. Manufactured in the U.S.A.



Approvals	Rod Size	Part Number	Model	Description	Ultimate Pullout (lbs)	UL Test Load (lbs)	UL Min Thick	FM Test Load (lbs)	FM Min Thick	Max Thick	Box Qty	Case Qty	Application
SWIVEL MOUNT													
	3/8"	8294922	SXP 20	Swivel X-Press 20	1061 (22 ga Vert) 829 (45° Off Vert)	750 (2" Pipe) 170 Vertical (Luminaire) 80 @ 45° (Luminaire) 283 Vertical (Conduit & Cable) 233 @ 45° (Conduit & Cable)	.029"	635 (2" Pipe)	.029"	.125"	25	125	Metal Deck
	3/8"	8295922	SXP 35	Swivel X-Press 35	1675 (16 ga Vert) 1558 (89° Off Vert)	1250 (3-1/2" Pipe) 250 Vertical (Luminaire) 80 @ 90° (Luminaire) 500 Vertical (Conduit & Cable) 333 @ 89° (Conduit & Cable)	.059"	635 (2" Pipe)	.029"	.125"	25	125	Purlin
	1/2"	8272957	SXP 2.0	Swivel X-Press 2.0	1061 (22 ga Vert) 829 (45° Off Vert)		.027"	.125"			25	125	Metal Deck
	1/2"	8271957	SXP 3.5	Swivel X-Press 3.5	1675 (16 ga Vert) 1558 (89° Off Vert)		.060"	.125"			25	125	Purlin

SAMMY X-PRESS IT® Installation Tool



Application	Product Features
	<ul style="list-style-type: none"> The Sammy X-Press expands to provide direct vertical attachment in: <ul style="list-style-type: none"> - metal deck (22-16 gauge) - z-purlin (18-16 gauge) Manufactured in the U.S.A.



Part Number	Model	Description	Qty
8194910	UXPIT*	Universal X-Press It Tool	1
8152910	XPDB	25/64" Drill Bit	1

*Tool Includes: Sleeve, Bit Receiver, Hex Wrench, and 25/64" Drill Bit.

SAMMYS® FOR CONCRETE

SAMMYS® FOR CONCRETE - Vertical Application



Application

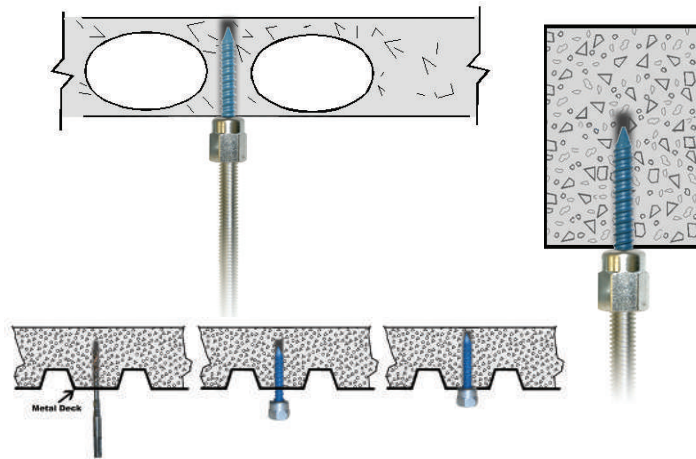

Product Features

- Easy two step process (Drill hole & drive Sammys concrete anchor).
- 1/4" pre-drilled pilot hole required.
- Concrete Installation Tool available for a one tool installation process.
- Manufactured in the U.S.A.
- **New Sammys for Cracked Concrete now available!**



Approvals	Rod Size	Part Number	Model	Screw Descriptions	Ultimate Pullout (lbs)*	FM Test Load (lbs)	Box Qty	Case Qty
VERTICAL MOUNT								
#14 Black Nut Driver Part # 8113910	1/4"	8058957	CST 200	5/16 x 1-3/4"	2400		25	125
	3/8"	8059957	CST 20	5/16 x 1-3/4"	2400	1475	25	125
#14SW Red Nut Driver Part # 8114910	3/8"	8145925	CST 20-SS	5/16 x 1-3/4"	2400		25	125
	1/2"	8060925	CST 2	5/16 x 1-3/4"	2400		25	125
ICC-ESR 2202	3/8"	8306957	CCST 516	5/16-14 x 2-1/2"	857**		25	125

For complete performance data see ICC Report ESR-2202

* Tested in 3000 PSI concrete ** Pullout strength for Cracked Concrete and Seismic Zones A-F

SIDEWINDER® FOR CONCRETE - Horizontal Application



Application

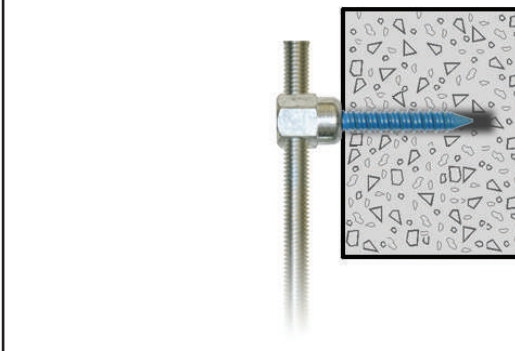

Product Features

- Easy two step process (Drill hole & drive Sammys concrete anchor).
- 1/4" pre-drilled pilot hole required.
- Concrete Installation Tool available for a one tool installation process.
- Manufactured in the U.S.A.
- **New Sammys for Cracked Concrete now available!**



Approvals	Rod Size	Part Number	Model	Screw Descriptions	Ultimate Pullout (lbs)*	FM Test Load (lbs)	Box Qty	Case Qty
HORIZONTAL MOUNT								
#14SW Red Nut Driver Part # 8114910	1/4"	8062957	SWC 200	5/16 x 1-3/4"	2450		25	125
	3/8"	8061957	SWC 20	5/16 x 1-3/4"	2450	1475	25	125
	3/8"	8307957	SW-CCST 516	5/16-14 x 2-1/2"	857**		25	125

* Tested in 3000 PSI concrete ** Pullout strength for cracked concrete and Seismic Zones A-F



SPECIAL NUT DRIVER SYSTEM: The nut drivers were designed with a unique spin-off feature which provides a fast and safe installation each time. When the face of the driver comes into contact with the material you are installing into, continue drilling until nut driver spins free. Installation is then complete. Warranty requires the use of the appropriate nut driver for installations.

SAMMYS SWIVEL HEAD™ FOR CONCRETE - Swivel Application



Application

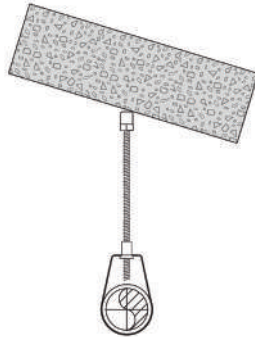

Product Features

- Installs vertically and swivels up to 89° in wood & concrete structures.
- Eliminates distortion of threaded rod.
- 1/4" pre-drilled pilot hole required.
- Concrete installation tool available for a one piece installation process.
- Manufactured in the U.S.A.
- **New Sammys for Cracked Concrete now available!**

Approvals	Rod Size	Part Number	Model	Screw Descriptions	Ultimate Pullout (lbs)*	Box Qty	Case Qty
SWIVEL MOUNT							
	3/8"	8269957	SH-GST/CST 20	5/16 x 1-3/4"	2537 in 3000 psi concrete 1459 @ 45° off vertical in 3000 psi concrete 2852 in 6000 psi concrete 1636 @ 45° off vertical in 6000 psi concrete	25	125
	1/2"	8303957	SH-GST/CST 2.0	5/16 x 1-3/4"	2537 in 3000 psi concrete 1459 @ 45° off vertical in 3000 psi concrete 2852 in 6000 psi concrete 1636 @ 45° off vertical in 6000 psi concrete	25	125
	3/8"	8308957	SH-CCST 516	5/16-14 x 2-1/2"	857**	25	125

Note: UL Listed for wood - see page 5

* Tested in 3000 PSI concrete ** Pullout strength for cracked concrete and Seismic Zones A-F

CONCRETE / WOOD INSTALLATION KIT



Application

Rotary Hammer Drill into concrete

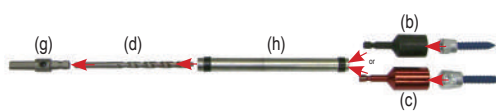

Hammer Drill into concrete

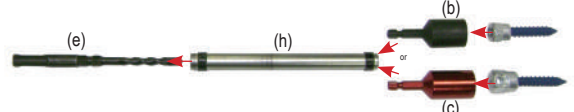

Part Number	Description	Each Qty
8122910	Concrete Installation Kit (a)	
Kit includes the following items:		
8113910	#14 Black Nut Driver (b)	1
8114910	#14 SW Red Nut Driver (c)	1
8116910	#250 Bit (1/4") (d)	1
8117910	SDS Bit (1/4") (e)	1
8118910	7/32 Wood Bit (f)	1
8120910	HEX 250 Bit Receiver (1/4") (g)	1
8098910	SL 250 Sleeve (h)	1
8121910	SDS B250 Bit Receiver (1/4")*	1

*Only sold separately - not included in kit.

ACCESSORIES

SAMMYS TOGGLE™



Application

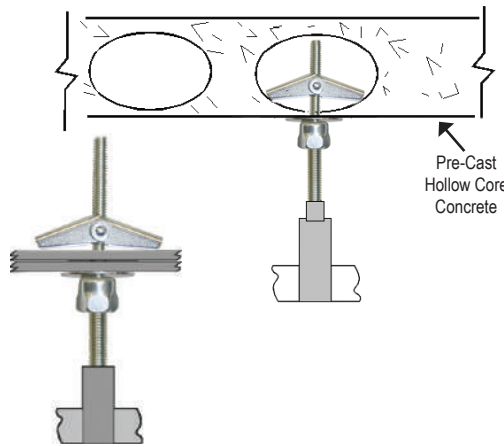

Installation Steps

1. Pre-drill a 5/8" hole with a regular drill or hole saw.
2. Insert SST screw into #14 black nut driver. With wing nut and washer on bolt, insert wing nut through surface, and begin installation.
3. When bolt is secure and nut driver spins free, stop drill motor and remove.
4. SST screw is now ready to receive 1/4", 3/8", or Metric all thread rod or bolt stock.



#14 Black Nut Driver
Part # 8113910

Rod Size	Part Number	Model	Screw Descriptions	Ultimate Pullout (lbs)	Box Qty	Case Qty
1/4"	8063925	SST 300	1/4 x 3"	450 (Lath & Plaster) 404 (2 Layers 5/8 Rock)	25	125
3/8"	8064925	SST 30	1/4 x 3"	450 (Lath & Plaster) 404 (2 Layers 5/8 Rock)	25	125

CEILING SCREWS



Application

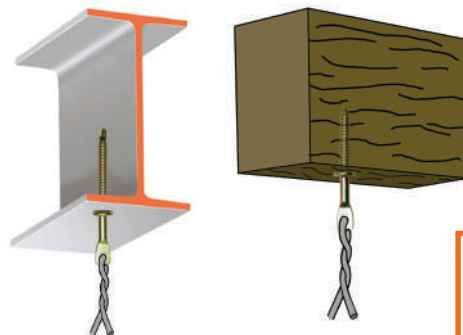

Use the **Speedy Pole Tool™** for easy installation of ceiling screws without ladders or scaffolding!
(see pg 13 for details)

Product Features

- 3/16" eyelet to accommodate common wire size.
- ICC approvals can be found at www.itwbuildex.com under Evaluation Report # ER-5367.



CWIT Installation Tool
Part # 8110910

Approvals	Substrate	Part Number	Model	Point	Description	Overall Total Length	Ultimate Pullout (lbs)	Max Gauge	ICC Test Load (lbs)	Box Qty	Case Qty
ICC	STEEL	8107957	CWSD 1*	Teks	1/4 x 1"	2"	472 (20 ga)	16 ga.	170 (20 ga.)	25	125
ICC	STEEL WOOD	8190957	CWSD 15*	Gimlet	1/4 x 1-1/2"	2-3/4"	472 (20 ga) 980 (Fir)	20 ga.	270 (20 ga.)	25	125
ICC	STEEL	8108957	CWSD 2*	Teks	1/4 x 2"	3-1/4"	472 (20 ga)	16 ga.	170 (20 ga.)	25	125
ICC		8110910	CWIT Installation Tool								1

* Does not comply with ROHS requirements

DEKTITE® PIPE FLASHING



Application

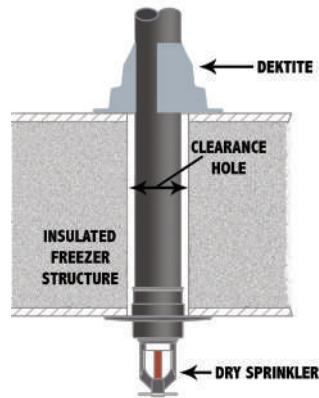

STAY UP TO CODE!
with a quicker, more efficient way to flash your refrigeration/freezer units.

Product Features

- Complies with NFPA 13 Code Changes.
- Flashing for dry pendant sprinklers subject to extreme temperature changes.
- One piece construction is easy to install.
- Pipe diameter markings ensure accurate fit.
- EPDM temperature range of -65°F to +250°F.

Part Number	Description	Pipe Outside Diameter	Dektite Base Diameter	Dektite Height	Box Qty
4001910	Mini	1/4" - 1-1/8"	3-1/2"	1-3/4"	20
4003910	1	1/4" - 2"	4-3/4"	3"	10
4004910	2	1-3/4" - 3-1/4"	6-1/4"	4"	10

SPEEDY POLE TOOL™

NEW DESIGN!
NOW COMES FULLY ASSEMBLED

Installation Instructions



Adjust the Pole Tool to length. The adjusting pin must be 18" below the base or the pin may interfere with the rod.

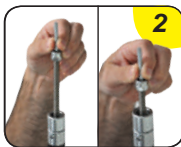

Load rod and Sammys into Pole Tool.



The socket will spin free when the screw is completely installed. Pull down to remove the Pole Tool.

Product Features

- Speed your labor by 25%
- Work from the ground up
- No scaffolding, ladders, or lifts
- Perfect for working in tight spaces, through ceiling grid, and high vaulted ceilings
- Works with any Vertical SAMMYS: Wood, Steel, or Concrete

Part Number	Description	Box Qty
SP4	Speedy Pole 4' - 12'	1
SP6	Speedy Pole 6' - 18'	1
8128910	Ceiling Wire Socket Driver	1

For Ceiling Wire Applications

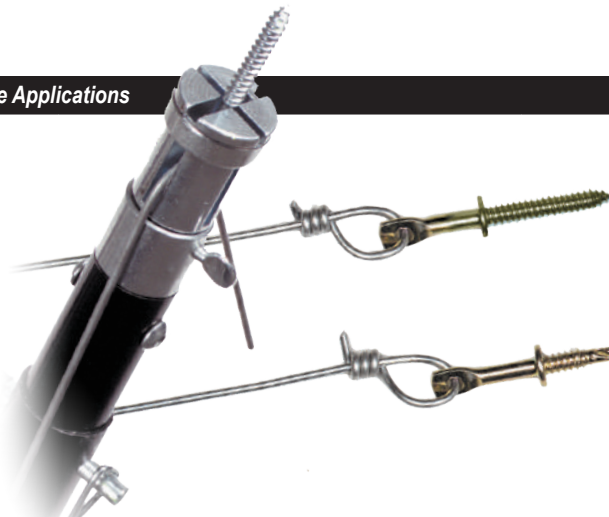

Driver hangs 12 or 9 gauge wire or jack chain



APPROVALS

Part Number	Model	Rod Size	Mount Direction	UL Max Pipe Size	UL Test Load (lbs)	UL Min Wood Thickness	FM Max Pipe Size	FM Test Load (lbs)	FM Min Wood Thickness	
SAMMYS FOR WOOD - PIPE HANGER										
8007957	GST 10	3/8"	Vertical	CPVC 1-1/2"	300	1-1/2"				
8020957	SWG 10	3/8"	Horizontal	CPVC 1-1/2"	300	1-1/2"				
8008957	GST 20	3/8"	Vertical	2-1/2"	850	1-1/2"	4"	1475	1-1/2"	
8068925	GST 20-SS	3/8"	Vertical	2-1/2"	850	1-1/2"				
8010957	GST 30	3/8"	Vertical	4"	1500	1-1/2"	4"	1475	1-1/2"	
8009925	GST 25-380	3/8"	Vertical	4"	1500	1-1/2"				
8022925	SWG 25-380	3/8"	Horizontal	3-1/2" - 4"	1500	1-1/2"				
8021957	SWG 20	3/8"	Horizontal	2-1/2" - 3"	1050	1-1/2"				
8073925	SWG 20-SS	3/8"	Horizontal	2-1/2"	850	1-1/2"				
8269957	SH-GST/CST 20	3/8"	45° Angle off Vertical	2-1/2"	850	1-1/2"				
8269957	SH-GST/CST 20	3/8"	45° Angle off Vertical	4"	1500	1-1/2"				
8139957	SH-GST 20	3/8"	17° Angle off Vertical	3"	1050	1-1/2"	4"	1475	1-1/2"	
SAMMYS FOR STEEL - PIPE HANGER										
						Min Steel Thick	Max Steel Thick			
8038957	DSTR 1	3/8"	Vertical	4"	1500	.035"	4"	1475	.105"	
8037957	DSTR 1-1/2	3/8"	Vertical	4"	1500	.035"	4"	1475	.105"	
8039957	DSTR 516	3/8"	Vertical	4"	1500	.037"	4"	1475	.105"	
8045957	DST 516	3/8"	Vertical	4"	1500	.188"	4"	1475	.188"	
8046957	TEK 50	3/8"	Vertical	4"	1500	.250"	4"	1475	.188"	
8055957	SWDR 1	3/8"	Horizontal	4"	1500	.037"	4"	1475	.060"	
8056957	SWDR 516	3/8"	Horizontal	4"	1500	.037"	4"	1475	.060"	
8054957	SWDR 1-1/2	3/8"	Horizontal	4"	1500	.037"	4"	1475	.060"	
8137957	SH-DSTR 1	3/8"	17° Angle off Vertical	4"	1500	.035"	4"	1475	.105"	
8268957	SH-TEK 50	3/8"	Vertical	2-1/2"	850					
			70° Angle off Vertical	4"	1500					
8150922	XP 20	3/8"	Vertical	2-1/2"	850	.027"	2"	940	.029"	
							4"	1475	.105"	
8153922	XP 35	3/8"	Vertical	4"	1500	.060"	2"	940	.029"	
							4"	1475	.125"	
8294922	SXP 20	3/8"	Vertical or up to 45°	2"	750	.027"	2"	635	.029"	
8295922	SXP 35	3/8"	Vertical or up to 89°	3-1/2"	1250	.060"	2"	635	.029"	
8293957	SWXP 35	3/8"	Horizontal	3-1/2"	1250	.060"				
SAMMYS FOR CONCRETE - PIPE HANGER										
8059957	CST 20	3/8"	Vertical				4"	1475	3000	
8061957	SWC 20	3/8"	Horizontal				4"	1475	3000	
8150922	XP 20	3/8"	Vertical	2-1/2"	850	Pre-Pour Structural @ 3000psi				
8150922	XP 20	3/8"	Vertical	2-1/2"	850	Post-Pour Range II LWC ≤ 35 PCF (lbs/ft³)				
SAMMYS FOR STEEL - LUMINAIRE FITTING										
						UL Load Rating (lbs)	UL Min Steel Thickness			
8150922	XP 20	3/8"	Vertical			185	.027"			
						250	.035"			
8153922	XP 35	3/8"	Vertical			185	.027"			
						250	.035"			
8181922	XP 200	1/4"	Vertical			185	.027"			
						250	.035"			
8294922	SXP 20	3/8"	Vertical			170	.027"			
			45°			80	.027"			
8295922	SXP 35	3/8"	Vertical			250	.060"			
			90°			80	.060"			
8293957	SWXP 35	3/8"	Horizontal			80	.060"			
SAMMYS FOR STEEL - CONDUIT, TUBING, AND CABLE										
						UL Load Rating (lbs)	UL Min. Steel Thickness	Listed Application		
8150922	XP 20	3/8"	Vertical	283	.027"	Max 4 trade size EMT, RMC, and IMC & 5 trade size rigid PVC conduit				
8153922	XP 35	3/8"	Vertical	500	.060"	Max 4 trade size EMT & 6 trade size RMC, IMC, and rigid PVC conduit				
8294922	SXP 20	3/8"	Vertical	283	.027"	Max 4 trade size EMT, RMC, and IMC & 5 trade size rigid PVC conduit				
8295922	SXP 35	3/8"	Vertical	500	.060"	Max 4 trade size EMT & 6 trade size RMC, IMC, and rigid PVC conduit				
8293957	SWXP 35	3/8"	Horizontal	500	.060"	Max 4 trade size EMT & 6 trade size RMC, IMC, and rigid PVC conduit				
8149957	CZ2000	1/4" or 3/8"	Onto Vertical Rod			UL Listed 4S16 - Cable Hanger, Cat. No. C-Z2000 Plenum Rated, Complies w/ NEC Standards				
Sheet Steel Gauges										
Gauge No.	22 ga.		20 ga.	18 ga.	16 ga.	14 ga.	12 ga.	1/8"	3/16"	1/4"
Nominal Decimal Equivalent	.030"		.036"	.048"	.060"	.075"	.105"	.125"	.188"	.250"
*SWG 25-380 Maximum pipe size in composite wood joist allowed by UL is 3-1/2"										
*SWG 25-380 Maximum pipe size in wood timber or joist allowed by UL is 4"										
**SWG 20 Maximum pipe size in composite wood joist allowed by UL is 2-1/2"										
**SWG 20 Maximum pipe size in wood timber or joist allowed by UL is 3"										
UL compliance with NEC Standards.										
UL and FM tests were performed in compliance with NFPA 13 Standards.										
Fastening requirement: 5 times weight of water-filled schedule 40 pipe plus 250 pounds.										

SPECIAL NOTES

Engineering Note

In 1996, the anchors listed by UL were tested in plate steel that measured .188" and .118". Subsequent testing was done for z-purlin applications in May 1997 using (.037") or 20 gauge steel. Most recently in 2008, testing with the new Sammy X-Press® was completed using (.030") or 22 gauge steel metal deck.

Sammys® Nut Drivers

Special nut drivers were designed to be used with Sammys. When the appropriate nut drivers are used for installation, the driver spins freely on the screw after installation is complete and eliminates the expected wrist snap, reduces over-torque, and prevents screw failure.

Steel Screws

Due to variations in hardness of certain metals, it should be noted that our self-drilling screws for steel will experience different drill speeds. 500-1500 RPM drill speed should be used.

Metric Products

Metric versions of the Sammy anchors are available at www.itwbuildex.com

Sammys for Seismic

Please visit www.itwbuildex.com for our current Seismic product offering.

Vibratory Environments

For attaching or anchoring in high vibratory environments, special care should be taken not just for building attachments but also for the hangers or assemblies being supported. Consult local code authorities for accepted anchoring devices.

Composite Joist/Truss

Truss manufacturers vary installation recommendations for composite joist. UL testing was completed to validate that Sammys and Sidewinders SWG 20 and SWG 25-380 can be installed into the top cord of a truss. Sammy GST 20 can be installed into the center of the lower cord of a composite joist. Penetration of the upright center web is permitted by some joist manufacturers. Consult truss manufacturer for recommended installation point.

Pre-drilling may be required by joist manufacturers. If so, pre-drill pilot hole 1/8" smaller than root diameter of fastener.

Consult the table below:

Model	Root Diameter	Hole Size
GST 20	.182"	1/8"
GST 25-380	.280"	7/32"
SWG 20	.182"	1/8"
SWG 25-380	.280"	7/32"

To increase efficiency of the installation process, sleeve tools, bit receivers, and wood bits are available for pre-drilling.

NFPA/NEC Standards

All UL and FM testing complies with NFPA 13 and NEC standards. Check with your local (AHJ) Authority Having Jurisdiction to confirm application and usage.

UL Listings / FM Approvals

UL and FM reports are available at www.itwbuildex.com



Technical Drawings

Technical drawings are available and can be downloaded at www.itwbuildex.com in the following formats: .dwg, .dxf, and .igs.

Manufactured in the U.S.A. Products

MANUFACTURED U.S.A.

Contact Information

Technical Assistance: (800) BUILDDEX Option #6 (x 3259)

Customer Service: (800) BUILDDEX Option #1

WOOD

STEEL

STEEL

CONCRETE

ACCESSORIES

APPROVALS



SAMMYS®

itwbuildex.com

National Headquarters
700 High Grove Blvd.
Glendale Heights, IL 60139
P: 630.825.7900

Customer Service
1765 Holmes Rd.
Elgin, IL 60123
P: 800.848.5611
E: orders@itwccna.com

Technical Support
P: 800.848.5611
E: technical@itwccna.com

Made in U.S.A.

Sammys, Sammy X-Press, Sammy X-Press It, Sidewinder, Sammy X-Press Swivel, Sammy X-Press Sidewinder, Tapcon, Sammy Saddle, Speedy Pole Tool, Spot-Rite Level, Dekite, Swivel Head, Sammys Toggle, and Tekts are trademarks of Illinois Tool Works, Inc. Deklite is a registered trademark of Deks Industries Pty Ltd.

© 2014 Illinois Tool Works, Inc.