

2013 CATALOG

PLUMBING SPECIALTY /// GAS SPECIALTY /// TOOLS



OUR SPECIALTY///YOUR EDGE

www.goTomahawk.com



Tomahawk wants you to gain an edge in the field. Our quality lines of plumbing specialty, gas specialty and tools will help you do just that.

Our focus on product innovation shapes new ideas for labor savings before, during or after an installation.

Our quality-tested solutions for finish plumbing provide the professional plumber peace of mind and helps you successfully build your brand, win bids and make profits.

The face of plumbing specialty is changing.

TOMAHAWK.
OUR SPECIALTY. YOUR EDGE.





TABLE OF CONTENTS

FORWARD	05
About	05
American Innovation	09
Featured Products	11
PLUMBING SPECIALTY	13
Closet Specialties & Repair	15
Tub & Shower Specialties & Repair	29
Lav/Sink Specialties & Repair	35
Tubular Specialties	47
GAS SPECIALTY	59
Log Lighter Products	61
TOOLS	69
PowerPEX™ Tools	71
Cutting Devices	77
Brushes & Abrasives	83
Wrenches	87
Other Tools & Accessories	91
APPENDIX	103
Alphabetical Index	105
Numerical Index	109
Samples	115
Reference Data	117
Sales & Reps	121
Warranty	125

PRODUCT DIRECTORY

PLUMBING SPECIALTY

- 15** **Closet Specialties & Repair**
- 16 Closet Bolts & Bolt Covers
- 19 Wedge-It
- 20 Gaskets & Cushions
- 24 Anti-Siphon Ballcock
- 24 Flush Valves & Parts
- 26 Flappers
- 27 Handles, Wires & Floats

- 29** **Tub & Shower Specialties & Repair**
- 30 Smart Spout
- 31 Standard Spout & Accessories
- 34 Shower Arm & Accessories

- 35** **Lav/Sink Specialties & Repair**
- 36 Escutcheons, Floor & Ceiling Plates
- 38 Supply Stop Valves
- 40 Supply Connectors
- 41 Washers, O-Rings & Gaskets
- 43 Other Lav/Sink Repair Accessories

- 47** **Tubular Specialties**
- 48 Plastic Tubular
- 51 Tailpiece Washers, Nuts & Adapters
- 54 Brass Tubular

GAS SPECIALTY

- 61** **Log Lighter Products**
- 63 HearthMaster™ & Accessories
- 67 Gas Ball Valve
- 67 Gas Ox Box™

TOOLS

- 71** **PowerPEX™ Tools**
- 72 F1807 & F2159
- 74 F2080
- 74 FitQuick

- 77** **Cutting Devices**
- 78 Tube Cutters
- 79 Deburring Tool
- 79 Utility Knife
- 80 Saws
- 81 Inside Pipe Cutters
- 82 Stud Punch

- 83** **Brushes & Abrasives**
- 84 Brushes
- 86 Abrasives

- 87** **Wrenches**
- 88 Slip Joint Pliers
- 88 Offset Ratchet Box Wrench
- 88 Telescopic Basin Wrench
- 89 Allen Wrench Set
- 89 Strap Wrench
- 89 Shower Arm Installation Tool
- 90 Plug Wrench
- 90 Faucet Seat Wrench
- 90 Socket Wrench Set
- 90 Water Heater Wrench

- 91** **Other Tools & Accessories**
- 92 Tools
- 96 Lubricant
- 96 PTFE Packing Rope & Tape
- 97 Duct Tape
- 97 Cement Stop Leak
- 97 Oakum
- 98 Gloves
- 99 Shoe Covers & Dust Masks
- 99 Tie Down Strap
- 100 Buckets, Boxes & Hooks

ABOUT

TOMAHAWK 07

The Idea
Why Tomahawk?
The Logo
New Communication
Customer Service

MARKS, INSIGNIA & CODES 08

List Price Disclaimer
Packaging Codes
Shipping & Packaging Disclaimer





Tomahawk – Another Sioux Chief Innovation

As a new brand in the Sioux Chief family, Tomahawk represents a more concentrated focus upon our Specialty and Tool items that are built upon the strong foundation and legacy of Sioux Chief.

Over the years, the specialty lines developed independently into three solid product categories:

- plumbing specialty
- gas specialty
- tools

These categories have been home to several respected industry mainstays, such as Plumb Perfect closet bolts, the HearthMaster Log Lighter products, and the Smart Spout replacement tub spout.

Sioux Chief set the cornerstone for success in plumbing specialty with these and other products. Tomahawk is built on that success.

Why Tomahawk?

Sioux Chief rough plumbing products often require additional Specialty items and tools to finish the installation.

For years, you have relied on Sioux Chief to produce and carry these vital extras that enable you to finish the job to a high standard. Our innovative and tested specialty plumbing products, gas products and tools have given you an edge in the field because they equal labor savings, quality and reputation building — and your business has grown. As a result, Sioux Chief has grown.

And while we have all gone about our regular business each day, our specialty plumbing and gas products and tool offerings have also quietly and consistently grown.

Today, these products represent a business in its own right, one that supports Sioux Chief's Supply, Drainage and Support categories and yet is worthy of its own name and brand — Tomahawk.

Our Tomahawk brand promise is to continue to provide and expand our offering in quality, innovative specialty plumbing and gas products and tools for you.

Our Specialty. Your Edge.

The Logo

The tomahawk is a serious tool. What you see in the Tomahawk logo is merely the head of a tomahawk, formed in the white space, connecting with its mark, which is a cutting edge — the kind of edge we want you to have as a result of relying on the Tomahawk brand.

New Communication

Tomahawk is working hard to supply you with the right information at the right time. From our new website and online catalog experience, to our information-packed posts that help build your business and brand via our social media presence on Facebook, YouTube and Twitter — you can connect with industry professionals, learn from our product videos or simply stay up-to-date.

Our Specialty + (Right Information @ the Right Time) = Your Edge.

Customer Service

The launch of Sioux Chief's new Tomahawk brand focuses on plumbing specialty, gas specialty and tools.

With this change, it is important to know that your customer service experience will remain the same.

Tomahawk, including both the new catalog and website, is fully supported by the same Sioux Chief customer service and sales processes, pricing programs, shipping services and product warranties.

Contact us anytime for additional information at 800-821-3944 or 816-779-6104, info@goTomahawk.com or www.goTomahawk.com.

MARKS, PACKAGING CODES & DISCLAIMER

List Price Disclaimer

All prices shown in the Tomahawk catalog are subject to change without notice up to time of shipment. Invoice totals and discounts will be calculated out to the fourth decimal digit. Any price discrepancies by Buyer must be brought to the attention of Seller within 60 days' notice, after which Tomahawk's invoice price calculation prevails.

Packaging Codes

The Packaging column highlights purchasing options (see Pkg column) while keeping similar products in consecutive rows. Codes for the Packaging column are repeated at the bottom of each spread.

B: Bulk | **C:** Cut Case | **D:** Dispenser Box | **T:** Tube

*: Individually Bar-Coded

Shipping & Packaging Disclaimer

Tomahawk, as a brand of Sioux Chief, is dedicated to having your experience remain consistent and transparent when ordering and communicating with us, with no change in service. Order the same way; the product will ship the same way and you will be billed the same Sioux Chief way.

Tomahawk is expanding our product line and developing packaging and promotions specific to our Tomahawk brand in the near future. During our transition, Tomahawk orders may arrive in Sioux Chief packaging.

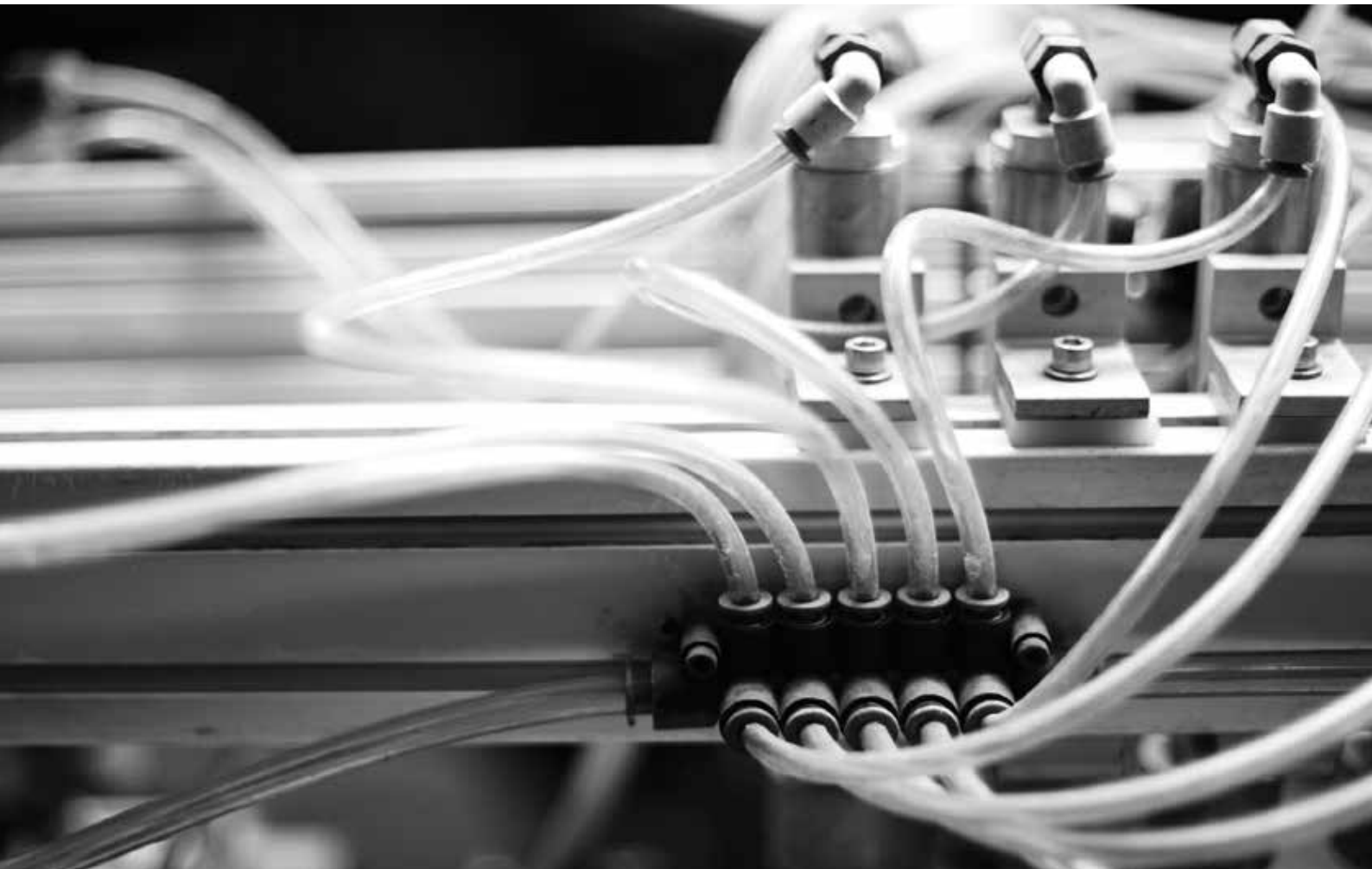

AMERICAN INNOVATION

MAKING IT IN AMERICA 10
Mission Statement
American Company
No Lead

OUR SPECIALTY///YOUR EDGE



Tomahawk Mission

Tomahawk's mission is to design, manufacture and distribute quality and innovative plumbing specialty, gas specialty and tool products while offering superior value and customer service to professional plumbing tradesmen and installers, through qualified distributors.

For plumbing professionals, Tomahawk means tested design and quality materials that embrace the Sioux Chief tradition of product development, built upon the goal to make plumbing installations easier, more effective and more efficient. For end users, this means lasting durability and peace of mind.

American Company

Tomahawk is a brand of Sioux Chief, a Buy American compliant company located in Peculiar, Missouri. We support the American worker whenever feasible by creating jobs and designing and manufacturing products in America.

Green initiative supporters should note that the total carbon footprint of a part made in America is half of that made in China and shipped to the USA.

American manufacturing generates almost 12% of the US Gross Domestic Product. It accounts for 60% of our exports and employs nearly 12 million people. 70% of US dollars spent on research and development come from the manufacturing sector.

Buy American when you can. We will succeed as Americans when you do!

No Lead

The Reduction of Lead in Drinking Water Act, a federal law enacted in 2011 and going into effect January 4, 2014, mandates the wetted surface of every pipe, fixture and fitting installed for use in potable water applications not contain more than .025% lead by weight.

Through innovation, production and inventory management processes, Tomahawk is committed to being ahead of the transition to the full implementation of this law.



FEATURED PRODUCTS

PLUMBING SPECIALTY 12

GAS SPECIALTY 12

TOOLS 12

OUR SPECIALTY///YOUR EDGE

FEATURED PRODUCTS



HearthMaster™
Log Lighter Kits
p.63



Long Branch™
Dishwasher Tailpiece
p.54



Smart Spout™
p.30



Plumb Perfect™
Closet Bolt
p.16



Smart Cap™
Closet Bolt Cover Cap
p.18



Trim Tite™
Shallow Escutcheon
p.36



Wedge-It™
Multi-Purpose Stability Wedge
p.19



PowerPEX™
F1807 Multi-Size Crimp Tool
p.72



PowerPEX™
V-Sleeve™ Compact Crimp Tool
p.73



PowerPEX™
F2080 Standard Tool Kit
p.75



Plastic Tube Cutter
p.78



Sawhorse™
Multi-Purpose Saw
p.80

PLUMBING SPECIALTY

- 15 CLOSET SPECIALTIES & REPAIR
- 29 TUB & SHOWER SPECIALTIES & REPAIR
- 35 LAV/SINK SPECIALTIES & REPAIR
- 47 TUBULAR SPECIALTIES





CLOSET SPECIALTIES & REPAIR

CLOSET SPECIALTIES	16
Closet Bolts & Bolt Covers	16
Wedge-It	19
Gaskets & Cushions	20
CLOSET REPAIR	21
Anti-Siphon Ballcock	24
Flush Valves & Parts	24
Flappers	26
Handles, Wires & Floats	27

PLUMBING



425

Plumb Perfect™ Closet Bolt

- Tensile strength exceeds 1,100 lbs. per bolt
- Thread design provides increased strength and smoother, faster threading
- 100% corrosion proof bolts are available in convenient 2½" and 3½" lengths
- Improved adaptability – open end nut now fits ½" sockets and fits under most bolt caps. Bolt base loads into any flange
- Unique design allows for quick and hassle free installation
- Pyramid base design keeps bolt upright and does not allow bolt to spin in flange, eliminating need to double nut bolt

Beware of cheap imports that can break!

Ask for the Sioux Chief original Plumb Perfect. Look for the Sioux Chief logo at the base of the bolt.

GAS

TOOLS



425-PBJ



For use with bolt caps. Fits ½" sockets.



Install over cap washer and hand tighten.



Tighten nut with wrench. (1 to 2 full turns)



Cut off excess bolt. Snap on bolt cap.

APPENDIX

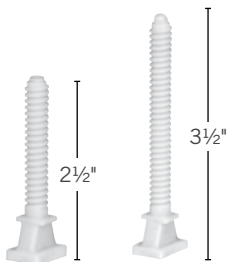

Related Product
Smart Cap

p 18



Item No	Description	Pkg	Min Qty	Case Qty	List Price
425	2½" bolt, bulk box	B	100	100	0.46 EA
425-PB	2½" bolt, 2/bag	B	25	250	0.98 PR
425-PBJ	2½" bolt, 2/bag, 50 bar-coded bags/dispenser box	D	1	1	50.50 EA
425-PBPK2	2½" bolt, 2/ bar-coded bag	C*	10	10	1.22 BG
427	3½" bolt, bulk box	B	100	100	0.54 EA
427-PB	3½" bolt, 2/bag	B	50	50	1.12 PR
427-PBJ	3½" bolt, 2/bag, 50 bar-coded bags/dispenser box	D*	1	1	62.00 EA
427-PBPK2	3½" bolt, 2/ bar-coded bag	C*	10	10	1.38 BG
425-N	Replacement Nut	B	100	500	0.35 EA

NEW

Solid Brass Closet Bolt

- Nickel-plated steel nut and zinc-plated washer included
- Nuts and washers also available separately



416



417



419

Item No	Description	Pkg	Min Qty	Case Qty	List Price
SOLID BRASS CLOSET BOLT					
410	1/4" x 20-2 1/4" bolt with nut & washer, bulk	B	100	1000	0.80 EA
410-PB	1/4" x 20-2 1/4" bolt with nut & washer, 2/bag	B	50	50	1.50 PR
411	1/4" x 20-3 1/2" bolt with nut & washer, bulk	B	100	500	1.07 EA
411-PB	1/4" x 20-3 1/2" bolt with nut & washer, 2/bag	B	50	50	2.13 PR
415	5/16" x 18-1 3/4" bolt with nut & washer, bulk	B	100	500	1.06 EA
415-PB	5/16" x 18-1 3/4" bolt with nut & washer, 2/bag	B	50	50	2.00 PR
416	5/16" x 18-2 1/4" bolt with nut & washer, bulk	B	100	500	1.19 EA
416-PB	5/16" x 18-2 1/4" bolt with nut & washer, 2/bag	B	50	50	2.48 PR
416PK2	5/16" x 18-2 1/4" bolt with nut & washer, 2/bag	C*	25	25	2.48 PR
COMPONENTS					
417	1/4" x 20, 7/16" hex, nickel-plated steel open end nut	B	100	1000	0.13 EA
418	5/16" x 18, 9/16" hex, nickelplated steel open end nut	B	100	1000	0.22 EA
419	Closet washer-zinc-plated steel (.042 thick)	B	100	5000	0.15 EA
490-11223	1/4" x 20, 7/16" hex, nickel-plated brass open end nut	B	25	2500	0.65 EA
490-11227	5/16" x 18, 9/16" hex, nickel-plated brass open end nut	B	25	2500	0.50 EA
490-11221	Closet washer-nickel-plated brass	B	25	2500	0.41 EA

Snap-It™ Brass Closet Bolt

- Nickel-plated steel nut and zinc-plated washers included

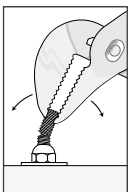

Snap off tip with pliers after installation.

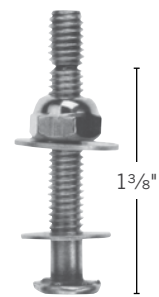

412-PB

Item No	Description	Pkg	Min Qty	Case Qty	List Price
412-PB	1/4" x 20-2 1/4" bolt with nut & washers, 2/bag	B*	50	50	1.92 PR
412-PBPK2	1/4" x 20-2 1/4" bolt with nut & washers, 2/bag	C*	25	25	2.02 BG
414-PB	5/16" x 18-2 1/4" bolt with nut & washers, 2/bag	B*	50	50	2.75 PR

Smart Cap™ Closet Bolt Cover Cap

Patent # 7,658,580 B1

- Taller cap eliminates the need to cut bolts
- Base creates a tight seal that helps provide a continuous sanitary seal between base and toilet
- Cap threads onto base and is less likely to get lost or knocked off



442-2W



Never cut brass bolts again. Bolts that are cut become too short to reuse when additional flooring is added.



Base is installed between the bowl and nut.



Cap screws onto base for a secure connection.

Related Product
Plumb Perfect

p 16



Item No	Description	Pkg	Min Qty	Case Qty	List Price
WHITE					
440-2W	Cover cap with 425-PB closet bolts, 2/bag	C*	1	25	2.75 BG
442-2W	Cover cap, 2/bag	C*	1	25	1.80 PR
BONE					
442-2B	Cover cap, 2/bag	C*	1	25	1.80 BG

Closet Bolt Cover Cap

- White polypropylene



490-11240

Item No	Description	Pkg	Min Qty	Case Qty	List Price
490-11240	White cap & snap-on washer, 2/bag	B*	1	50	1.25 PR

Wedge-It™ Multi-Purpose Stability Wedge

- Stiff polypropylene is drivable
- Soft rubber-like PVC is easy to trim and resists slipping on tile floors
- Dozens of uses on the job site, in the office, home, etc.
- Corrosion proof
- Interlocking for stability and stacking

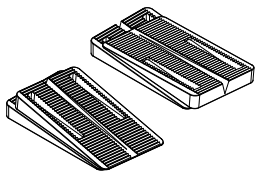

Stack in the same or opposite direction.

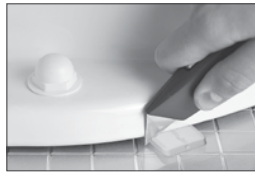

Ideal for leveling unsteady closet bowls.

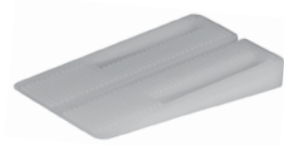

460-10

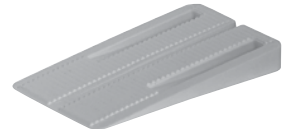

460-20



460-20J

Item No	Description	Pkg	Min Qty	Case Qty	List Price
460-10	Stiff polypro, bulk box	B	100	1000	0.26 EA
460-10J	Stiff polypro, 10/bag, 20 bags/dispenser box	D*	1	1	58.00 EA
460-11300	Stiff polypro job pack, 10/bag	B	1	10	3.12 BG
460-20	Soft PVC, bulk box	B	100	1000	0.35 EA
460-20J	Soft PVC, 10/bag, 20 bags/dispenser box	D*	1	1	74.00 EA
460-11310	Soft PVC job pack, 10/bag	B	1	10	3.95 BG

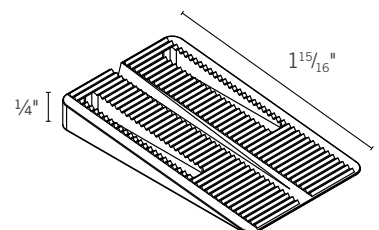

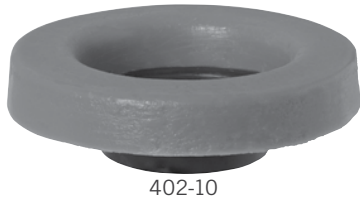

402-10

Wax Gaskets

- Plastic flange extends discharge opening
- Gasket forms a watertight, gas-tight and odor-tight seal
- Fits 3" and 4" waste lines
- Meets Fed spec TT-P-1536A

PLUMBING

GAS

TOOLS

APPENDIX

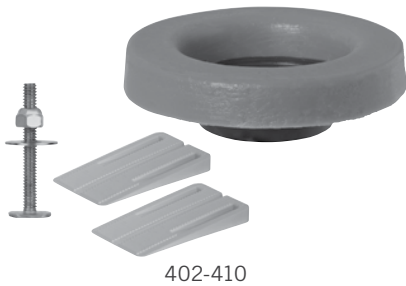

402-410

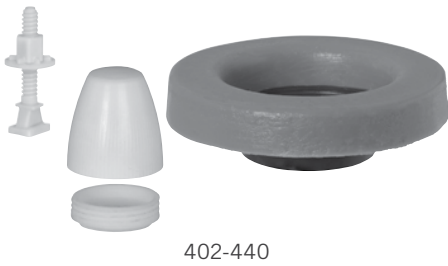

402-440

Item No	Description	Pkg	Min Qty	Case Qty	List Price
402-10	Wax gasket with poly flange	B	24	24	2.25 EA
402-410	Wax gasket with 410-PB 3/4" x 2 1/4" brass bolt with two 460-20	B*	24	24	3.88 EA
402-427	Wax gasket with 427-PB open nut 3 1/2" bolt	B*	24	24	3.75 EA
402-440	Wax gasket with 425 and 442-2W smart cap	B*	24	24	5.50 EA

Closet Bowl Cushion

- Bowl setting alternative material to wax
- Pre-drilled holes on wide flange model hold bolts upright, eliminating need to double nut



490-10540



490-10545

Item No	Description	Pkg	Min Qty	Case Qty	List Price
SPONGE RUBBER - RING TYPE					
490-10540	5 3/8" O.D. x 3 3/8" I.D. x 9/16" high	B	10	10	4.08 EA
490-10541	5 1/4" O.D. x 3 7/16" I.D. x 1/2" high	B	10	10	3.44 EA
490-10542	5 3/8" O.D. x 3 1/2" I.D. x 3/4" high	B	10	10	3.72 EA
490-10543	5 5/8" O.D. x 3 1/2" I.D. x 1" high	B	10	10	4.36 EA
SPONGE RUBBER - WIDE FLANGE					
490-10545	6 3/4" O.D. x 3 1/2" I.D. x 3/8" high	B	10	10	3.70 EA
490-10546	6 3/4" O.D. x 3 1/2" I.D. x 9/16" high	B	10	10	4.59 EA
490-10547	6 3/4" O.D. x 3 1/2" I.D. x 3/4" high	B	10	10	5.11 EA
490-10548	6 3/4" O.D. x 3 1/2" I.D. x 1" high	B	10	10	6.85 EA

Tank Bowl Kits

Universal

- 3/4" high universal sponge gasket with deluxe tank-to-bowl bolts

American Standard†

- 1 1/8" high recessed gasket with deluxe brass tank-to-bowl bolts

Gerber†

- 1 3/16" high gasket with deluxe brass tank-to-bowl bolts

Kohler†

- 3/4" high molded rubber gasket with three deluxe brass tank-to-bowl bolts
- 3/4" high sponge gasket with deluxe brass tank-to-bowl bolts

Eljer†

- 7/16" high gasket with deluxe brass tank-to-bowl bolts

Mansfield†

- Sponge gasket with three deluxe solid brass tank-to-bowl bolts
- Also used for American Standard* gasket (our 490-10660)



490-10555

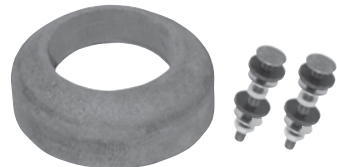

490-10560

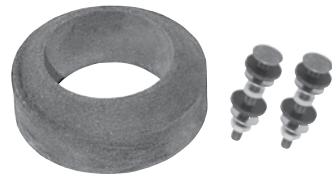

490-10565

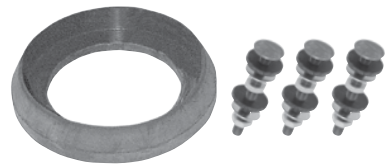

490-10570



490-10572



490-10575

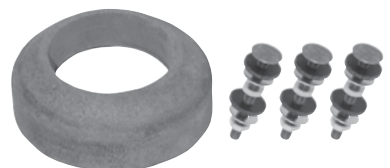

490-10585

Item No	Description	Pkg	Min Qty	Case Qty	List Price
UNIVERSAL					
490-10555	3/4" high universal tank bowl kit	B*	1	25	7.75 EA
AMERICAN STANDARD†					
490-10560	1 1/8" high tank bowl kit	B*	1	25	7.75 EA
GERBER†					
490-10565	1 3/16" high tank bowl kit	B*	1	25	7.75 EA
KOHLER†					
490-10570	3/4" high tank bowl kit	B*	1	25	10.25 EA
490-10572	Tank bowl kit with "sponge" gasket	B*	1	25	10.85 EA
ELJER†					
490-10575	7/16" high tank bowl kit	B*	1	25	7.75 EA
MANSFIELD†					
490-10585	Tank bowl kit with 3 tank bolts and sponge gasket	B*	1	25	10.50 EA

† Indicates the part was not made by original manufacturer, but manufactured to the same specifications as original part.

PLUMBING



490-10656

GAS



490-10661

TOOLS



490-10666

APPENDIX



490-10671



490-10673



490-10676

Tank-to-Bowl Gaskets

Universal

- 3⁵/₈" O.D. × 2¹/₄" I.D. × 3/4" high

American Standard† / Mansfield†

- 3¹/₂" O.D. × 2¹/₈" I.D. × 1¹/₈" high

Gerber†

- 3¹/₄" O.D. × 2¹/₈" I.D. × 1³/₁₆" high

Kohler†

- Molded rubber: 3³/₄" O.D. × 2¹/₂" I.D. × 3/4" high
- Sponge: 3¹/₄" O.D. × 2" I.D. × 3/4" high

Eljer†

- 3¹/₈" O.D. × 2¹/₄" I.D. × 7/16" high

Item No	Description	Material	Pkg	Min Qty	Case Qty	List Price
UNIVERSAL						
490-10656	3/4" high gasket	molded rubber	B	25	25	1.21 EA
AMERICAN STANDARD†/MANSFIELD†						
490-10661	1 1/8" high gasket	sponge	B	25	25	1.54 EA
GERBER†						
490-10666	1 3/16" high gasket	sponge	B	25	25	1.78 EA
KOHLER†						
490-10671	3/4" high gasket	molded rubber	B	25	25	1.58 EA
490-10673	3/4" high gasket	sponge	B	25	25	1.31 EA
ELJER†						
490-10676	7/16" high gasket	molded rubber	B	25	25	1.75 EA

† Indicates the part was not made by original manufacturer, but manufactured to the same specifications as original part.

Tank Bolt Set

- Cloth inserted washers
- 7/8" truss head with deep slot

Item No	Description	Pkg	Min Qty	Case Qty	List Price
452-PB	Solid brass bolts with ²³ / ₃₂ " head and hex nuts; plated washers and wing nut; cloth inserted washers, 2/bag	B	50	50	5.25 PR
490-10500	Solid brass bolts with 7/8" head and hex nuts; brass washers and cloth inserted washers, 2/bag	B*	1	50	7.74 PR
490-10502	Cloth inserted washer for tank bolt	B	25	250	0.32 EA
490-10505	Brass hex nut for 490-10500	B	25	200	1.11 EA



452-PB



490-10500



490-10502

Spud Gasket

- Installs on flush valve spud
- Seals brass spud to china
- Natural rubber



490-11520

Item No	Description	Pkg	Min Qty	Case Qty	List Price
490-11520	1 1/4" urinal spud gasket	B	5	25	0.98 EA
490-11522	1 1/2" closet spud gasket	B	5	25	1.00 EA
490-11530	1" x 3/4" closet spud gasket	B	5	25	1.25 EA

Sloan Vacuum Breaker

- Three-piece vacuum breaker kit

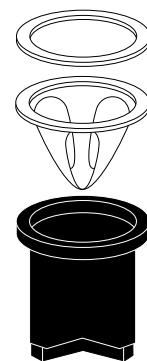

490-10700

Item No	Description	Pkg	Min Qty	Case Qty	List Price
490-10700	Sloan† vacuum breaker kit	B*	1	12	2.44 EA

† Indicates the part was not made by original manufacturer, but manufactured to the same specifications as original part.

PLUMBING

GAS

TOOLS

APPENDIX

Anti-Siphon Ballcock

- 8½" Hoov-R-Line† Replacement
- Rebuild kit includes spare screw (reuse original brass screws when repairing)
- Conforms to ASSE 1002



Item No	Description	Pkg	Min Qty	Case Qty	List Price
490-10465	8½" anti-siphon ballcock assembly	B	1	12	14.50 EA
490-10466	Ballcock rebuild kit, includes 1 spare screw	B	1	12	2.98 EA
490-10467	Ballcock top assembly kit	B	1	12	4.15 EA

† Indicates the part was not made by original manufacturer, but manufactured to the same specifications as original part.

Plastic Flush Valve

- Complete replacement plastic flush valve with flapper
- Blue vinyl chemical-resistant flapper
- Stainless steel chain



Item No	Description	Pkg	Min Qty	Case Qty	List Price
490-11150	8" flush valve with chemical-resistant flapper	B*	1	12	7.66 EA
490-11151	10⅝" flush valve with chemical-resistant flapper	B*	1	12	7.90 EA
490-11152	Gasket only for 490-11150	B	5	25	1.88 EA

American Standard† Flush Valve Seal

- For American Standard† (N-3055)



Item No	Description	Pkg	Min Qty	Case Qty	List Price
490-10320	Flush valve replacement seal	B*	1	50	1.63 EA

† Indicates the part was not made by original manufacturer, but manufactured to the same specifications as original part.

American Standard† Flush Valve Disc Without Helmet

- Genuine American Standard – snap-on or screw-on

With Helmet

- Snap-on or screw-on

Item No	Description	Attachment Method	Pkg	Min Qty	Case Qty	List Price
WITHOUT HELMET						
490-10302	A. S. #33643-07	snap-on	B*	1	25	4.16 EA
490-10312	A. S. #73383-07	screw-on	B*	1	25	4.18 EA
WITH HELMET						
490-10306	Flush valve disc†	snap-on	B	25	25	1.74 EA
490-10316	Flush valve disc†	screw-on	B	25	25	2.10 EA

† Indicates the part was not made by original manufacturer, but manufactured to the same specifications as original part.



490-10312



490-10316

Mansfield Flush Valve Gasket

- Genuine Mansfield, old and new styles

Item No	Description	Pkg	Min Qty	Case Qty	List Price
490-10340	Mansfield gasket – old style	B*	1	25	4.26 EA
490-10341	Mansfield gasket – new style	B*	1	25	2.22 EA

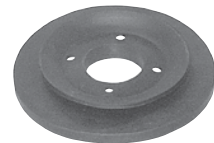

490-10340



490-10341

Flush Valve Balls For Douglas† and Eljer†

Item No	Description	Pkg	Min Qty	Case Qty	List Price
490-10206	3" replacement flush valve tank ball for Douglas models	B*	1	25	4.21 EA
490-10211	Replacement flush valve tank ball for Eljer models	B*	1	50	2.08 EA

† Indicates the part was not made by original manufacturer, but manufactured to the same specifications as original part.



490-10206



490-10211



490-10125



490-10115



490-10108



490-10110



490-10120

Flappers

- Replacement flappers for most popular closet brands
- Produced with high quality co-polymer vinyl or ABS materials
- Chemical-resistant flappers prevent warping
- Stainless steel (Type 303) chains will not rust

Item No	Description	Pkg	Min Qty	Case Qty	List Price
ELJER "LOW BOY"					
490-10125	Plastic with styrofoam cone - Genuine Eljer Flapper for Patrician, Windsor and Canterbury Aqualine models	B*	1	20	4.31 EA
KOHLER† ROUND					
490-10115	Vinyl with 8" stainless steel chain and hook	B*	1	25	5.46 EA
CHEMICAL RESISTANT - VINYL RESISTS WARPING					
490-10108	Blue vinyl with 9" stainless steel chain and hook	B*	1	25	4.11 EA
490-10112	Clear vinyl with 9" chain. 1.6 GPF with 4 orifices	B*	1	25	7.28 EA
490-10110	Clear vinyl with 9" stainless steel chain and hook, 3-way, co-polymer	B*	1	25	4.04 EA
STANDARD STYLE					
490-10120	ABS with TPR seal - fits Kohler†, Am. Standard† and Coast†, with 9" chain and hook	B*	1	25	5.42 EA
490-10121	TPR seal for 1.6 GPF models, 9" stainless steel chain and hook	B*	1	25	6.27 EA
490-10122	TPR replacement seal only	B*	1	25	1.21 EA

† Indicates the part was not made by original manufacturer, but manufactured to the same specifications as original part.

PLUMBING

GAS

TOOLS

APPENDIX

Tank Handles

Metal Tank Handle

- 8" brass arm

American Standard†/Eljer†

- 4" arm

American Standard† Neo Angle Mount

- 45° arm for Cadet II series

Kohler† Neo Angle Mount

- For Wellworth II series

Eljer† Side Mount

- New Emblem series

Mansfield ABS

- Non-bendable arm for water saver flush valve

Item No	Description	Pkg	Min Qty	Case Qty	List Price
METAL HANDLE WITH 8" BRASS ARM					
490-11100	Chrome metal handle, die cast nut, & cushion washer, 1/bag	B*	1	25	4.17 EA
490-11101	Chrome metal handle, die cast nut, & cushion washer	B	50	50	3.29 EA
490-11120	Chrome metal handle, brass nut, & cushion washer, 1/bag	B*	1	15	8.25 EA
AMERICAN STANDARD†/ELJER†					
490-11130	Chrome-plated ABS tank handle with 4" arm, 1/bag	B*	1	12	2.95 EA
AMERICAN STANDARD† NEO MOUNT					
490-11157	Chrome-plated ABS, 1/bag	B*	1	12	6.05 EA
KOHLER† NEO ANGLE MOUNT					
490-11155	Chrome-plated die-cast with ABS arm, 1/bag	B*	1	12	12.02 EA
ELJER† SIDE MOUNT					
490-11159	Chrome-plated die cast with brass arm	B*	1	12	8.10 EA
MANSFIELD ABS					
490-11140	Chrome-plated ABS	B*	1	12	6.36 EA

† Indicates the part was not made by original manufacturer, but manufactured to the same specifications as original part.



490-11100

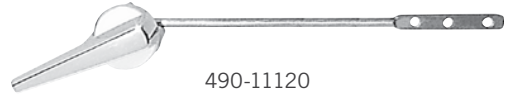

490-11120



490-11130



490-11157



490-11155

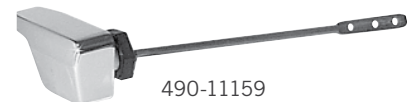

490-11159

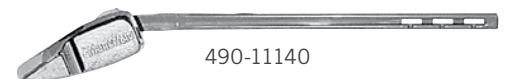

490-11140

PLUMBING

GAS

TOOLS

APPENDIX

Eljer Touch-Flush Tank Ball & Handle Set

- Clip style handle lock

Item No	Description	Pkg	Min Qty	Case Qty	List Price
490-10325	Eljer† Flush valve tank ball & handle set	B*	1	12	10.31 EA

† Indicates the part was not made by original manufacturer, but manufactured to the same specifications as original part.



490-10325

TUB & SHOWER SPECIALTIES & REPAIR

SMART SPOUT	30
STANDARD SPOUT & ACCESSORIES	31
SHOWER ARM & ACCESSORIES	34

PLUMBING



972-32

GAS



972-36

TOOLS



972-3RA

APPENDIX



972-3RAKIT

Smart Spout™

Replacement Tub Spout for 1/2" Copper Tube

Patent # 7,373,674

- Installs directly onto 1/2" copper stub out with #2 Phillips screwdriver
- Slip-fit convenience; secure, clean, tight to finished wall eliminating the need to caulk
- 5 1/4" overall length in three finish options
- Free Dry Seal Pipe Collar included with every Smart Spout
- Optional copper extension adapter available

Smart Spout™ Extension Adapter

1/2" CTS Extension Nipple

- Reduced end fits inside Type M or Type L copper to extend the length of the stub out



Tightens firm and flush to the finished wall.

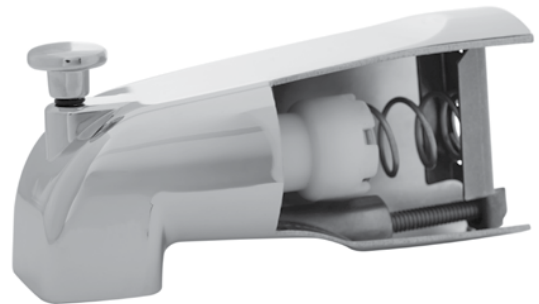

See installation video on YouTube: thvideo.us/your_edge



972-361PK2

Related Product
Dry Seal Pipe Collar

p 31



Item No	Description	Finish	Pkg	Min Qty	Case Qty	List Price
972-32	Smart Spout	chrome	B*	1	18	16.15 EA
972-32RB	Smart Spout	oil-rubbed bronze	B*	1	18	18.25 EA
972-32SN	Smart Spout	satin nickel	B*	1	18	18.25 EA
972-36	Smart Spout with shower diverter	chrome	B*	1	18	21.10 EA
972-36RB	Smart Spout with shower diverter	oil-rubbed bronze	B*	1	18	24.25 EA
972-36SN	Smart Spout with shower diverter	satin nickel	B*	1	18	24.25 EA
NEW 972-361PK2	Smart Spout with shower diverter & repair adapter kit, clamshell	chrome	B*	1	6	27.67 EA
NEW 972-362PK2	Smart Spout with shower diverter & repair adapter kit, clamshell	satin nickel	B*	6	6	30.25 EA
REPAIR ADAPTER						
NEW 972-3RA	1/2" CTS Extension 5/BG		B*	1	10	11.25 BG
NEW 972-3RAKIT	1/2" CTS Extension Repair Kit 1/BG**		B*	1	10	6.90 BG

**Kit includes: Extension adapter, sand cloth, 2-part epoxy, applicator stick and instruction sheet.

Tub Spout

- Chrome-plated zinc
- 5¼" overall length
- Tapered threads

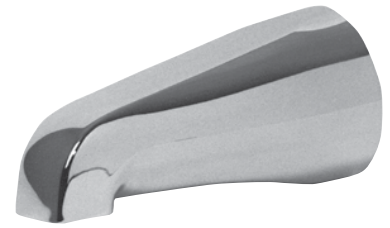

972-10

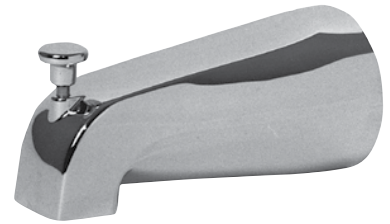

972-15

Item No	Connection	Pkg	Min Qty	Case Qty	List Price
WITH FRONT DIVERTER					
972-15	½" FIP nose end	B*	1	50	15.37 EA
972-35	Slip connects to ⅝" O.D. with 1⅜" adjustment	B*	1	50	19.48 EA
NO DIVERTER					
972-10	½" FIP nose end	B*	1	50	8.61 EA
972-20	¾" or ½" FIP nose end with ½" × ¾" bushing	B*	1	50	8.46 EA
972-30	Slip connects to ⅝" O.D. with 1⅜" adjustment	B*	1	50	15.24 EA

Dry Seal Pipe Collar™ Water/Moisture Barrier

Patent # 7,197,777

- Creates a watertight seal around pipe or tube
- Thin, tapered design compresses tightly to wall
- Helps keep moisture out of wall cavity which helps prevent mold growth



928-2

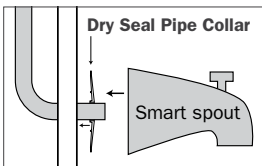

Related Product
Smart Spout

p 30

Item No	Description	Pkg	Min Qty	Case Qty	List Price
928-12	½" IPS	B	50	500	0.23 EA
928-125	½" shower arm	B	50	500	0.23 EA
928-13	¾" IPS	B	50	500	0.23 EA
928-2	½" CTS	B	50	500	0.23 EA
928-3	¾" CTS	B	50	500	0.23 EA

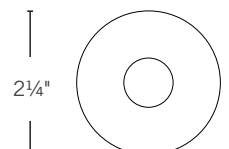

PLUMBING

GAS

TOOLS

APPENDIX



972-100

Tub Spout Escutcheon

- For use with 1/2" CTS, 1/2" or 3/4" IPS
- Chrome-plated brass with foam gasket
- Helps protect against leaks between spout and wall

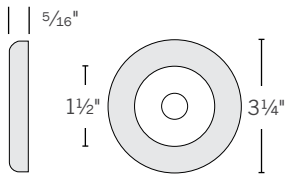
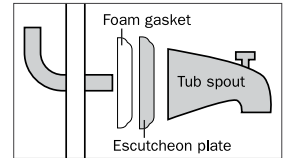

Item No	Description	Pkg	Min Qty	Case Qty	List Price
972-100	Tub spout seal escutcheon - chrome	B*	1	12	9.97 EA



974-60102

Tub Faceplate Blank

- Two hole chrome-plated steel blank faceplate with two chrome-plated screws



974-60100

Trip Lever

- Two hole tub faceplate with two 2" chrome-plated screws and one 3/32" x 3/4" brass cotter key

Item No	Description	Pkg	Min Qty	Case Qty	List Price
BLANK					
974-60102	Blank tub faceplate, two hole, chrome-plated steel with 2" chrome screws/bag	B*	1	12	4.01 EA
TRIP LEVER FACEPLATE					
974-60100	Chrome-plated Zamac, two hole with spring, two chrome screws and brass cotter key/bag	B*	1	20	5.69 EA
TRIP LEVER FACEPLATE ACCESSORIES					
974-60105	Screw - 2" chrome-plated brass for faceplate	B	6	120	1.80 EA

Tub Overflow Gasket

- Molded sponge



974-60116

Item No	Description	Pkg	Min Qty	Case Qty	List Price
974-60116	Molded tub overflow gasket	B	12	120	1.00 EA

Shower WallNut™ Shower Arm Adapter

Patent # 6,378,912

- Stub out to shower arm connection is made outside the finished wall. No hidden leaks behind the wall that promote mold growth
- Stub out with copper tube, just like other fixtures
- No pipe seal tape or pipe joint compound needed on shower arm threads

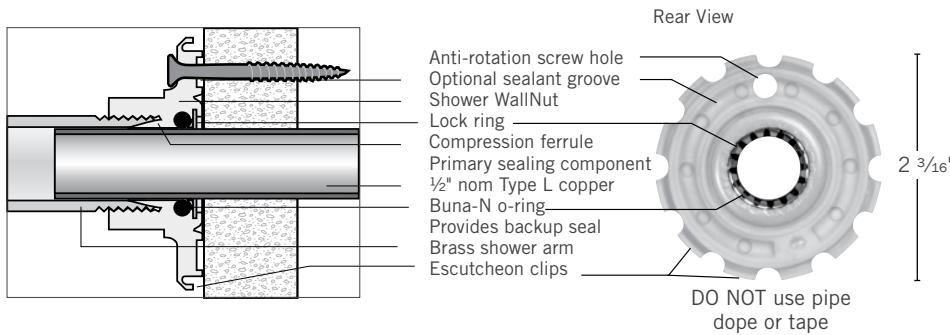

307-625
Patent # 6,460,432



307-616

Required components for warranty

Sioux Chief's **Shower WallNut System** carries a Limited Lifetime Warranty only when all of the following Sioux Chief components are used and installed per manufacturer's instructions:

1. Sioux Chief copper stub out elbow or preformed copper shower riser
2. Strong Arm Bracket with WallNut Lock Block
3. Shower WallNut Shower Arm Adapter



SATIN NICKEL AND OIL RUBBED BRONZE ESCUTCHEON FINISHES

Satin Nickel matches	Delta® Satin Nickel Kohler® Vibrant Brushed Nickel Price Pfister® Brushed Nickel Moen® Brushed Nickel
Oil Rubbed Bronze matches	Moen® Oil Rubbed Bronze Delta® Venetian Bronze Danze® Oil Rubbed Bronze Price Pfister® Oil Rubbed Bronze

Item No	Description	Escutcheon Finish	Pkg	Min Qty	Case Qty	List Price
SHOWER WALLNUT KITS						
616-02C	WallNut with escutcheon, bagged	chrome	B*	25	25	4.75 EA
616-02P	WallNut with escutcheon, bagged	polished brass	B*	25	25	4.75 EA
616-02RB	WallNut with escutcheon, bagged	oil-rubbed bronze	B*	1	25	18.00 EA
616-02SN	WallNut with escutcheon, bagged	satin nickel	B*	1	25	16.75 EA
616-02W	WallNut with escutcheon, bagged	white enamel	B*	25	25	4.35 EA
TOOLS & ACCESSORIES						
307-625	Shower Arm Installation Tool, individually bagged		B*	1	6	7.55 EA
307-616	WallNut Removal Tool, bagged		B*	1	10	16.25 EA



Shower Arm Installation Tool

Patent # 6,460,432

- Easier shower arm installations
- Allows shower arm installation with no external damage
- Wrench locks into shower arm for secure, no slip installation
- Can be used on all brass shower arms
- Heavy-duty malleable iron wrench with galvanized finish

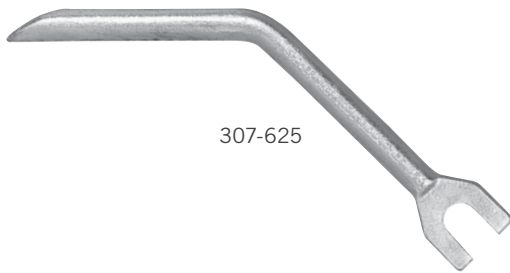

307-625



Item No	Description	Pkg	Min Qty	Case Qty	List Price
307-625	Shower arm installation tool, individually bagged	B	1	6	7.55 EA

Shower Arm and Accessories

- Chrome-plated finish

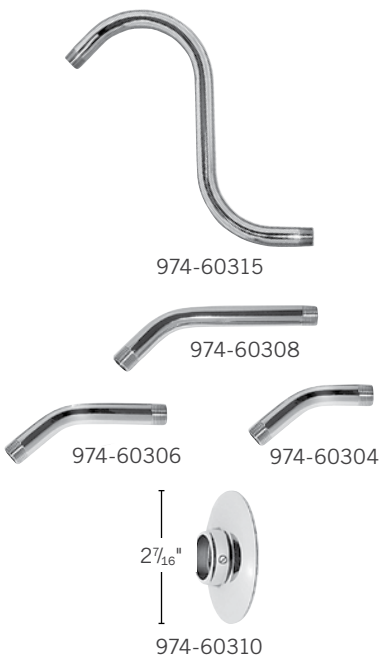

974-60315

974-60308

974-60306

974-60304

2 7/16"

974-60310

Item No	Description	Pkg	Min Qty	Case Qty	List Price
STANDARD SHOWER ARM					
974-60304	4" long x 1/2" MIP	B*	1	25	5.81 EA
974-60306	6" long x 1/2" MIP	B*	1	25	6.86 EA
974-60308	8" long x 1/2" MIP	B*	1	25	7.88 EA
"S" TYPE SHOWER ARM					
974-60315	"S" type, 1/2" MIP, 10" rise	B*	1	10	29.70 EA
SHOWER ARM ACCESSORIES					
974-60310	Flange with set screw	B*	1	10	3.65 EA

Shower Head Adjustable Spray

- 1 3/4" diameter
- Chrome-plated brass
- 2.5 GPM

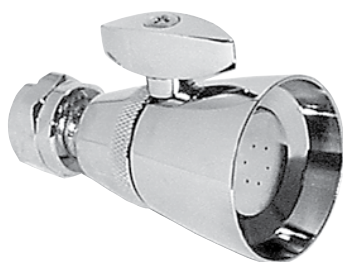

974-60300

Item No	Description	Pkg	Min Qty	Case Qty	List Price
974-60300	Shower head	B*	1	6	23.00 EA

LAV/SINK SPECIALTIES & REPAIR

ESCUTCHEONS, FLOOR & CEILING PLATES	36
SUPPLY STOP VALVES	38
SUPPLY CONNECTORS	40
WASHERS, O-RINGS, GASKETS	41
OTHER LAV/SINK REPAIR ACCESSORIES	43

PLUMBING



920-2W



921-6W



922-5W

GAS

TOOLS

APPENDIX

Trim Tite™

Shallow Escutcheon

- Corrosion proof. Will never rust or pit
- Will not come loose. Molded-in “memory” retains a permanent grip on pipe or tube
- Will not scratch the tube and disrupt compression connections
- Low cost and attractive appliance white color makes the Trim Tite an excellent substitution for chrome-plated or stainless steel escutcheons
- IPS sizes available for steel, PVC and ABS Sch. 40
- 1" CTS and 1" through 2" IPS sizes have deluxe 3½" O.D.

Deep Tubular Escutcheon

- 3" deep, extra wide 4" base
- Perfect for pedestal lavatory installations
- Perfect for covering waste-arm adapters



No more rust, corrosion or pitting.



Give all your stub outs the professional look of the Trim Tite.

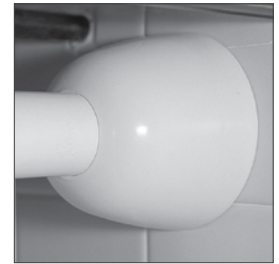

Covers most wall openings. Perfect for pedestal lavatory installations.

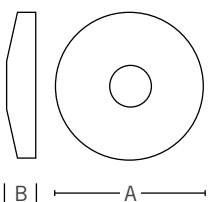

Item No	Description	Dimensions		Pkg	Min Qty	Case Qty	List Price
		A	B				
ESCUTCHEON							
920-1W	¾" CTS	2½"	9/16"	B	50	500	0.16 EA
920-2W	½" CTS	2½"	9/16"	B	25	250	0.18 EA
920-2WPK2	½" CTS, 2/bag	2½"	9/16"	C*	10	10	0.65 BG
920-3W	¾" CTS	2½"	9/16"	B	25	250	0.20 EA
920-3WPK2	¾" CTS, 2/bag	2½"	9/16"	C*	10	10	0.68 BG
920-4W	1" CTS	3½"	9/16"	B	20	100	0.45 EA
920-4WPK2	1" CTS, 2/bag	3½"	9/16"	C*	10	10	1.20 BG
921-2W	½" IPS	2½"	½"	B	50	500	0.20 EA
921-2WPK2	½" IPS, 2/bag	2½"	½"	C*	10	10	0.69 BG
921-3W	¾" IPS	2½"	½"	B	50	500	0.22 EA
921-3WPK2	¾" IPS, 2/bag	2½"	½"	C*	10	10	0.74 BG
921-4W	1" IPS	3½"	9/16"	B	20	100	0.41 EA
921-4WPK2	1" IPS, 2/bag	3½"	9/16"	C*	10	10	1.22 BG
921-6W	1½" IPS	3½"	9/16"	B	20	100	0.39 EA
921-6WPK2	1½" IPS, 1/bag	3½"	9/16"	C*	10	10	0.63 BG
921-7W	2" IPS	3½"	9/16"	B	20	100	0.41 EA
921-7WPK2	2" IPS, 1/bag	3½"	9/16"	C*	10	10	0.65 BG
DEEP ESCUTCHEON							
922-5W	1¼" tubular	4"	3"	B	25	25	0.65 EA
922-5WPK2	1¼" tubular	4"	3"	C*	10	10	0.93 EA
922-6W	1½" tubular	4"	3"	B	25	25	0.65 EA
922-6WPK2	1½" tubular	4"	3"	C*	10	10	0.93 EA

Snap One™ Floor and Ceiling Plate

- Available in white or chrome-plated polypropylene
- Split for pre-piped jobs
- 100% rust proof

Item No	Description	Dimensions		Pkg	Min Qty	Case Qty	List Price
		A	B				
CHROME-PLATED ABS							
926-2	½" CTS	2½"	⅜"	B	12	120	1.09 EA
926-2PK2	½" CTS, 1/bag	2½"	⅜"	C*	12	12	1.35 BG
926-3	¾" CTS	2¾"	⅜"	B	12	120	1.12 EA
926-3PK2	¾" CTS, 1/bag	2¾"	⅜"	C*	12	12	1.40 BG
926-4	1" CTS	3"	⅜"	B	12	120	1.23 EA
926-4PK2	1" CTS, 1/bag	3"	⅜"	C*	12	12	1.51 BG
927-2	½" IPS	2¾"	⅜"	B	12	120	1.09 EA
927-2PK2	½" IPS, 1/bag	2¾"	⅜"	C*	12	12	1.40 BG
927-3	¾" IPS	3"	⅜"	B	12	120	1.21 EA
927-3PK2	¾" IPS, 1/bag	3"	⅜"	C*	12	12	1.60 BG
927-4	1" IPS	3⅜"	⅜"	B	12	120	1.30 EA
927-4PK2	1" IPS, 1/bag	3⅜"	⅜"	C*	12	12	1.51 BG
927-5PK2	1¼" IPS, 1/bag	3⅝"	⅜"	C*	12	12	2.19 BG
927-6	1½" IPS	3⅝"	⅜"	B	12	120	1.83 EA
927-6PK2	1½" IPS, 1/bag	3⅝"	⅜"	C*	12	12	2.28 BG
927-7	2" IPS	4⅜"	⅜"	B	12	120	2.03 EA
927-7PK2	2" IPS, 1/bag	4⅜"	⅜"	C*	12	12	2.55 BG
WHITE ABS							
926-2W	½" CTS	2½"	⅜"	B	12	120	0.73 EA
926-3W	¾" CTS	2¾"	⅜"	B	12	120	0.77 EA
926-4W	1" CTS	3"	⅜"	B	12	120	0.88 EA
927-2W	½" IPS	2¾"	⅜"	B	12	120	0.76 EA
927-3W	¾" IPS	3"	⅜"	B	12	120	0.77 EA
927-4W	1" IPS	3⅜"	⅜"	B	12	120	0.87 EA
927-6W	1½" IPS	3⅝"	⅜"	B	12	120	1.05 EA
927-7W	2" IPS	4⅜"	⅜"	B	12	120	1.04 EA
927-8W	3" IPS	4⅝"	⅜"	B	12	120	1.97 EA



926-2



926-2W

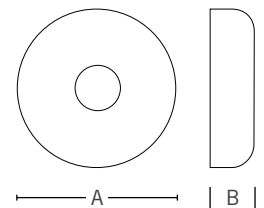

Shallow Escutcheon

- Chrome-plated Steel
- Sure grip fit

Item No	Description	Dimensions		Pkg	Min Qty	Case Qty	List Price
		A	B				
910-2	½" CTS	2½"	⅜"	B	25	250	0.32 EA
910-2PK2	½" CTS, 2/bag	2½"	⅜"	C*	10	10	1.06 EA
910-3	¾" CTS	2½"	½"	B	25	250	0.34 EA
910-3PK2	¾" CTS, 2/bag	2½"	½"	C*	10	10	1.10 EA
911-2	½" IPS	2½"	½"	B	25	250	0.36 EA
911-2PK2	½" IPS, 2/bag	2½"	½"	C*	10	10	1.10 EA
911-3	¾" IPS	2½"	½"	B	25	250	0.40 EA
911-3PK2	¾" IPS, 2/bag	2½"	½"	C*	10	10	1.15 EA
911-4	1" IPS	2 ¹³ / ₁₆ "	½"	B	25	250	0.46 EA
911-4PK2	1" IPS, 2/bag	2 ¹³ / ₁₆ "	½"	C*	10	10	1.25 EA
911-6	1½" IPS (Sch. 40 DWV)	3"	½"	B	25	250	0.55 EA
911-6PK2	1½" IPS (Sch. 40 DWV), 1/bag	3"	½"	C*	10	10	0.83 EA
911-6D	1½" IPS (Sch. 40 DWV)	3½"	¾"	B	25	250	0.76 EA
911-7	2" IPS (Sch. 40 DWV)	3½"	⅝"	B	25	250	0.91 EA
911-7PK2	2" IPS (Sch. 40 DWV), 1/bag	3½"	⅝"	C*	10	10	1.16 EA

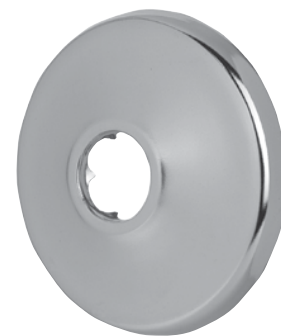

910-2



PLUMBING

GAS

TOOLS

APPENDIX

Floor & Ceiling Plate

- Chrome-plated steel
- Split for pre-piped jobs



916-2

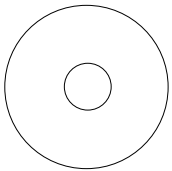

A

Item No	Description	Dia. A	Pkg	Min Qty	Case Qty	List Price
916-2	1/2" CTS	2 3/8"	B	12	120	1.10 EA
916-2PK2	1/2" CTS, 1/bag	2 3/8"	C*	12	12	1.45 BG
916-3	3/4" CTS	2 3/8"	B	12	120	1.12 EA
916-3PK2	3/4" CTS, 1/bag	2 3/8"	C*	12	12	1.49 BG
916-4	1" CTS	2 3/8"	B	12	120	1.18 EA
916-4PK2	1" CTS, 1/bag	2 3/8"	C*	12	12	1.51 BG
917-2	1/2" IPS	2 3/8"	B	12	120	1.01 EA
917-2PK2	1/2" IPS, 1/bag	2 3/8"	C*	12	12	1.29 BG
917-3	3/4" IPS	2 3/8"	B	12	120	1.10 EA
917-3PK2	3/4" IPS, 1/bag	2 3/8"	C*	12	12	1.41 BG
917-4	1" IPS	3 5/8"	B	12	120	1.20 EA
917-4PK2	1" IPS, 1/bag	3 5/8"	C*	12	12	1.49 BG
917-6	1 1/2" IPS	3 5/8"	B	12	120	1.28 EA
917-6PK2	1 1/2" IPS, 1/bag	3 5/8"	C*	12	12	1.58 BG

Fit Quick Quarter-Turn Stop Valve

- Chrome plated
- Valves tested to 200 PSI at 200°F
- 1/4-turn ball valve operation



TH648QB220A



TH648QBD220A



TH648QB220S



Individually bagged with tube stiffeners



Item No	Description	Pkg	Min Qty	Case Qty	List Price
TH648QB220A	1/2" Push-Fit x 3/8" O.D. angle stop	C*	12	12	12.16 EA
TH648QB220S	1/2" Push-Fit x 3/8" O.D. straight stop	C*	12	12	12.65 EA
TH648QBD220A	1/2" Push-Fit x 3/8" O.D. dual angle stop	C*	12	12	18.25 EA

1/4-Turn Stops

- Angle
- Straight
- Dual Outlet

- Chrome-plated brass
- 1/4-turn positive on and off
- Oval handle for ease of operation
- Individually boxed
- UPC/IAPMO listed

Item No	Description	Pkg	Min Qty	Case Qty	List Price
1/4-TURN ANGLE STOP					
110-SA21	1/2" sweat x 3/8" compression	B	10	150	9.60 EA
110-A31	5/8" x 3/8" compression	B	10	150	9.10 EA
110-XA21	1/2" PEX x 3/8" compression	B	10	150	9.60 EA
110-CA21	1/2" CPVC x 3/8" compression	B	10	150	9.35 EA
110-FA21	1/2" FIP x 3/8" compression	B	10	150	10.10 EA
1/4-TURN STRAIGHT STOP					
109-S21	1/2" sweat x 3/8" compression	B	10	150	6.92 EA
109-31	5/8" x 3/8" compression	B	10	150	7.94 EA
109-X21	1/2" PEX x 3/8" compression	B	10	150	7.06 EA
109-C21	1/2" CPVC x 3/8" compression	B	10	150	8.57 EA
109-F21	1/2" FIP x 3/8" compression	B	10	150	7.34 EA
DUAL OUTLET STOP					
109-310	5/8" x 3/8" x 1/4" compression	B	10	100	9.96 EA
109-311	5/8" x 3/8" x 3/8" compression	B	10	100	10.03 EA



110-FA21



109-S21



109-310

Standard Supply Stop Compression Connection

- Chrome-plated brass
- Individually bagged

Item No	Connection	Pkg	Min Qty	Case Qty	List Price
290-20400	3/8" O.D. x 3/8" O.D. compression	B*	1	20	8.75 EA

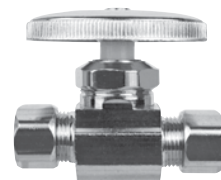

290-20400

PEX Standard Supply Stop Angle and Straight

- Poly and brass ferrule included
- Chrome-plated brass

Item No	Connection	Pkg	Min Qty	Case Qty	List Price
ANGLE					
648X2FA	1/2" PEX x 3/8" O.D. compression	B	5	60	9.13 EA
STRAIGHT					
648X2FS	1/2" PEX x 3/8" O.D. compression	B	5	60	10.37 EA

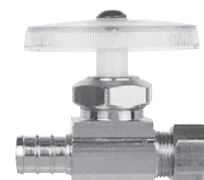

648X2FS

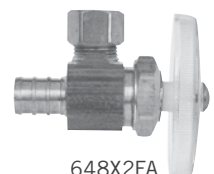

648X2FA

PLUMBING

GAS

TOOLS

APPENDIX

PLUMBING

GAS

TOOLS

APPENDIX

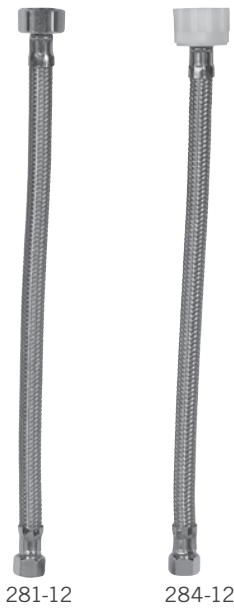

281-12

284-12



Stainless Steel Supply Connectors Lavatory or Closet

- Lavatory connectors have Santoprene inner core
- Closet connectors have PVC inner core
- 304 stainless steel braided outer material
- Flexible for ease of installation
- Connectors crimped on for positive seal
- UPC/IAPMO listed

Item No	Description	Pkg	Min Qty	Case Qty	List Price
SS ICE MAKER CONNECTOR					
281-072	72" long x 1/4" comp. x 1/4" FIP	B	1	12	8.48 EA
SS LAV CONNECTORS					
281-12	12" long x 3/8" comp. x 1/2" FIP	B	100	100	4.29 EA
281-16	16" long x 3/8" comp. x 1/2" FIP	B	100	100	4.78 EA
281-20	20" long x 3/8" comp. x 1/2" FIP	B	100	100	4.61 EA
281-30	30" long x 3/8" comp. x 1/2" FIP	B	100	100	6.65 EA
SS CLOSET CONNECTORS					
284-09	9" long x 3/8" comp. x 7/8" FIP	B	100	100	3.14 EA
284-12	12" long x 3/8" comp. x 7/8" FIP	B	100	100	3.38 EA
284-20	20" long x 3/8" comp. x 7/8" FIP	B	100	100	4.30 EA

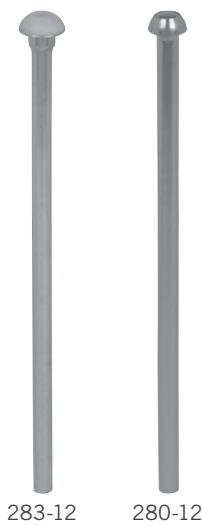

283-12

280-12

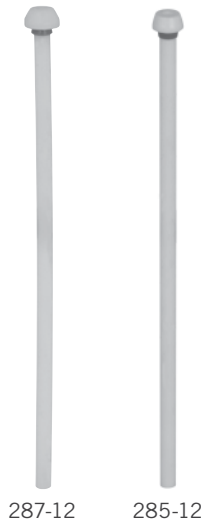

287-12

285-12



Supply Tube Lavatory Sink

- Chrome-plated copper or PEX
- Copper tubes are one piece with nylon insert
- 100% PEX tubes have molded head and bagged nylon ferrules

Closet

- Chrome-plated copper or PEX
- Copper closet tubes include rubber nose piece

Ferrules

- Brass for copper tubes
- Poly for PEX tubes

Item No	Description	Material	Pkg	Min Qty	Case Qty	List Price
LAV-SINK SUPPLY TUBE						
280-12	3/8" O.D. x 12"	copper	✓ B	100	100	4.73 EA
280-20	3/8" O.D. x 20"	copper	✓ B	100	100	8.35 EA
280-36	3/8" O.D. x 36"	copper	✓ B	50	50	11.85 EA
285-12	3/8" O.D. x 12" with nylon ferrules	PEX	B	100	100	0.96 EA
285-20	3/8" O.D. x 20" with nylon ferrules	PEX	B	100	100	1.25 EA
285-30	3/8" O.D. x 30" with nylon ferrules	PEX	B	100	100	1.75 EA
285-36	3/8" O.D. x 36" with nylon ferrules	PEX	B	100	100	1.99 EA
CLOSET SUPPLY TUBE						
283-12	3/8" O.D. x 12" with rubber nose piece	copper	B	50	50	6.40 EA
283-20	3/8" O.D. x 20" with rubber nose piece	copper	B	50	50	9.45 EA
287-12	3/8" O.D. x 12" with nylon ferrules	PEX	B	100	100	1.00 EA
287-20	3/8" O.D. x 20" with nylon ferrules	PEX	B	100	100	1.39 EA
FERRULES						
280-100	3/8" nominal	brass	B	100	2000	0.50 EA
285-100	3/8" nominal	poly	B	100	10000	0.10 EA

Supply Tube Extension Copper – 3/8" O.D. Male Sweat x Female Sweat

- Soft copper tube
- Great for faucet change-outs or supply tube extensions

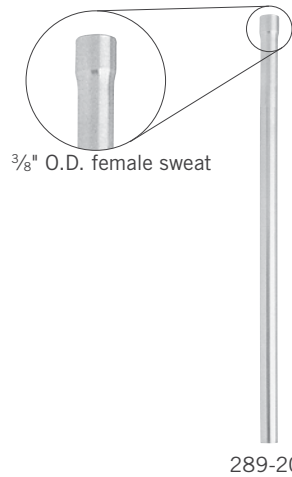

289-20

Item No	Length	Description	Pkg	Min Qty	Case Qty	List Price
289-12	12"	3/8" O.D. male sweat x female sweat	B	100	100	2.34 EA
289-20	20"	3/8" O.D. male sweat x female sweat	B	100	100	3.70 EA

Supply Step Washer for Lavatory or Closet

- Deluxe rubber lavatory supply washer with brass friction ring

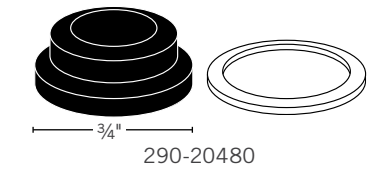

290-20480

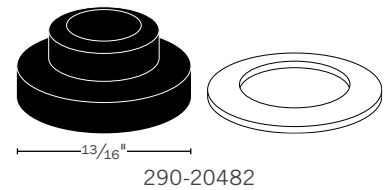

290-20482

Item No	Description	Pkg	Min Qty	Case Qty	List Price
290-20480	Lavatory 3/8" tall	B	50	500	0.50 EA
290-20482	Closet 7/16" tall	B	50	500	0.50 EA

SBR Bibb Washer Flat

- SBR (synthetic blended rubber)
- Includes 150 assorted washers with six 10-24 bibb screws
- Washer chest includes 270 washers in plastic chest complete with snap-in chrome wire holders

Beveled

- SBR (synthetic blended rubber)
- Includes 150 assorted washers with six 10-24 bibb screws
- Washer chest includes 170 washers in plastic chest complete with snap-in chrome wire holders

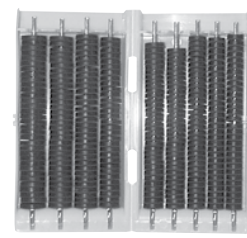

291-30126



291-30125



291-30226



291-30225

Item No	Description	Pkg	Min Qty	Case Qty	List Price
FLAT WASHER					
291-30125	SBR flat bibb washer kit	B*	1	10	22.18 EA
291-30126	SBR flat bibb washer chest	B*	1	10	40.30 EA
BEVELED WASHER					
291-30225	SBR beveled bibb washer kit	B*	1	10	29.00 EA
291-30226	SBR beveled bibb washer chest	B*	1	10	35.25 EA

PLUMBING

GAS

TOOLS

APPENDIX

Buna-N O-Ring

- Kit includes 150 assorted o-rings in a 12-compartment plastic box



291-30380

Item No	Description	Pkg	Min Qty	Case Qty	List Price
291-30380	Buna-N o-ring kit	B*	1	10	29.50 EA

Hose Washer

- Standard rubber hose washer



291-30500

Item No	Description	Pkg	Min Qty	Case Qty	List Price
291-30500	Washer	B	12	240	0.25 EA

Aerators

Faucet

- Chrome-plated brass
- 2.2 GPM maximum
- Complies with ANSI A112.18.1M

Adapter

- Chrome-plated brass



290-21100



290-21110

Item No	Description	 Pkg	Min Qty	Case Qty	List Price
AB 1953					
FAUCET AERATORS					
290-21100	Standard combo male/female non-slotted	✓ B	6	48	2.75 EA
290-21104	¹³ / ₁₆ " × 27 male threaded non-slotted	✓ B	6	48	2.93 EA
ADAPTER					
290-21110	Dual thread (¹⁵ / ₁₆ "-27 female thread / ⁵⁵ / ₆₄ " male thread) × ³ / ₄ " male thread	B	5	250	4.75 EA

Kitchen Hose Spray Kit and Accessories

- Universal coupling connection:
1/8" MIP with 1/8" FIP x 1/4" FIP
- Accessories available in black or white



242-10



242-20

Item No	Description	Color	Pkg	Min Qty	Case Qty	List Price
242-10	Kit with universal coupling connection	black	B*	1	10	11.52 EA
242-20	Plastic hose guide with stainless steel skirt	black	B*	1	100	2.00 EA
242-25	Universal spray head only	black	B*	1	10	5.73 EA
242-20102	Kit with universal coupling connection	white	B*	1	10	12.80 EA
242-20116	Plastic hose guide with stainless steel skirt	white	B*	1	25	1.85 EA

Dishwasher Air Gap

- Heavy-duty model has a solid brass chrome-plated cap
- Economy model has a chrome-plated plastic cap
- Inlet 1/2" hose barb; outlet 3/4" hose barb
- Molded polypropylene body, full 3/8" passageway
- Uniquely designed inlet tube and inner cup eliminates spitting/dischage action



249

249-20135



Item No	Description	Pkg	Min Qty	Case Qty	List Price
249	Heavy-duty air gap with chrome-plated brass cap	B	25	25	9.85 EA
249-20135	Economy air gap with chrome-plated poly cap	B*	1	10	5.15 EA

Faucet Hole Cover

- Available in chrome-plated steel or ABS
- 2" cover includes putty cup
- ABS material will not corrode



961-6



961-7



961-20155

Item No	Description	Pkg	Min Qty	Case Qty	List Price
961-6	1 3/4" cover, chrome-plated steel, toggle nut	B	25	25	1.35 EA
961-7	2" cover, chrome-plated steel, wing nut	B	25	25	1.73 EA
961-20150	2" cover, chrome-plated steel, wing nut	B*	1	25	2.09 EA
961-20155	1 3/4" white ABS, o-ring seal, wing nut	B*	1	25	3.05 EA
961-20158	1 3/4" bone ABS, o-ring seal, wing nut	B*	1	25	2.96 EA

PLUMBING

GAS

TOOLS

APPENDIX



901



902

Dishwasher Drain Connector

Item No	Description	Pkg	Min Qty	Case Qty	List Price
901	Black elastomer adapter only – bulk pack	B	100	100	0.93 EA
902	Black elastomer adapter with 100% stainless steel hose clamps – slotted/hex screws	B	50	50	3.15 EA



905

Dishwasher Drain Hose

- 5/8" connects dishwasher pump to air gap inlet, directly to our Long Branch tailpiece or to a disposal tap-in (with a connector kit)
- 7/8" connects the air gap outlet to branch tailpiece or disposal tap-in
- Maximum Temperature: 225°F at 20 PSI

Related Products

Long Branch Tailpiece p 51



Item No	Description	Pkg	Min Qty	Case Qty	List Price
905	5/8" I.D. × 50 ft. coil	B*	1	1	62.00 CL
905-PK	5/8" I.D. × 50 ft. (full coils only)	B	1	1	1.24 FT
906	7/8" I.D. × 50 ft. coil	B*	1	1	86.50 CL
906-PK	7/8" I.D. × 50 ft. (full coils only)	B	1	1	1.73 FT



Hose Clamp

- 300 series stainless steel band and housing
- 1/2" wide × 0.025 thick steel band for strength
- Finished edges prevent hose damage



901-10

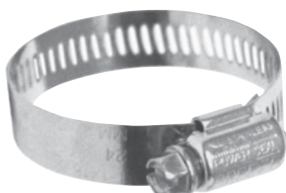

901-12

Item No	Description	Pkg	Min Qty	Case Qty	List Price
901-10	9/16" min – 1 1/16" max	B	10	100	0.97 EA
901-12	1 1/16" min – 1 1/4" max	B	10	100	1.07 EA
901-16	1 3/16" min – 1 1/2" max	B	10	100	1.10 EA
901-20	1 3/16" min – 1 3/4" max	B	10	100	1.11 EA
901-24	1 1/2" min – 2" max	B	10	100	1.20 EA
901-28	1 5/16" min – 2 1/4" max	B	10	100	1.23 EA
901-32	1 9/16" min – 2 1/2" max	B	10	100	1.27 EA

Garbage Disposal Replacement Parts



290-20185



290-20180

Item No	Description	Pkg	Min Qty	Case Qty	List Price
290-20180	Replacement In-Sink-Erator† drain ell gasket, bagged	B*	5	25	0.75 EA
290-20185	7" long poly disposal elbow	B*	1	12	3.32 EA

† Not made by original manufacturer, but manufactured to same specifications as original part.

Anti-Siphon Auto Vent

- For secondary venting only. Each drainage system must have a main vent stack
- To be installed in a readily accessible location with free flow of air, never in a sealed wall cavity
- Sealing disc of auto vent must be located at least 6" above the top of the trap arm
- Two fixtures may be drained by a common 1½" drain pipe. Three or more fixtures will require a 2" drain pipe
- ABS material



239

Item No	Description	Pkg	Min Qty	Case Qty	List Price
239	1½" MIP vent	B	50	50	3.92 EA
239PK2	1½" MIP vent, bag	C*	10	10	4.66 EA

TUBULAR SPECIALTIES

PLASTIC TUBULAR	48
TAILPIECE WASHERS, NUTS, & ADAPTERS	51
BRASS TUBULAR	54

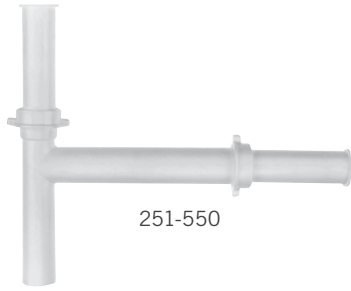

Disposal Waste Kit End Outlet

- Telescopic with baffle tee and 6" sink tailpiece
- Available in white or black polypropylene

Item No	Description	Color	Pkg	Min Qty	Case Qty	List Price
251-550	Disposal waste kit	white	B	25	25	7.11 EA
251-550B	Disposal waste kit	black	B	25	25	7.30 EA



Dishwasher Tailpiece

- One piece polypropylene body with baffle

Item No	Dimensions	Tubular Connection	Branch Connection	Color	Pkg	Min Qty	Case Qty	List Price
231-2	1½" × 8"	direct	½" hose barb	white	B	25	25	2.60 EA
231-3	1½" × 8"	direct	¾" hose barb	white	B	25	25	2.61 EA
232-2	1½" × 8"	slip joint	½" hose barb	white	B	25	25	2.88 EA
232-3	1½" × 8"	slip joint	¾" hose barb	white	B	25	25	2.88 EA
232-3B	1½" × 8"	slip joint	¾" hose barb	black	B	25	25	2.89 EA



Traps

S Traps

- 1½" tube body × 18" long
- Tubular polypropylene
- Wing nuts and washers included

P Traps

- Tubular polypropylene
- Wing nuts and washers included



Item No	Size	Description	Color	Pkg	Min Qty	Case Qty	List Price
S TRAPS							
234-2	1½"	PVC adapter, slip joint connection	white	B	25	25	7.02 EA
P TRAPS							
234-5	1¼"	P trap	white	B	25	25	3.08 EA
234-5B	1¼"	P trap	black	B	25	25	3.08 EA
234-10	1½"	P trap with trap adapter	white	B	25	25	2.07 EA
234-10B	1½"	P trap with trap adapter	black	B	25	25	2.07 EA

End Outlet Waste

Direct Connect

- Telescopic 12" to 16" with baffle tee
- Available in white or black polypropylene

Universal

- Telescopic 12" to 16" with baffle tee
- Slip joint with two direct connect adapters
- Available in white or black polypropylene

Wye Branch – Direct Connect

- Telescopic 12" to 16" with baffle tee
- 1/2" or 3/4" "Y" branch connection
- Available in white or black polypropylene

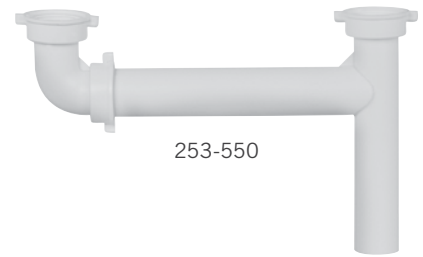

253-550

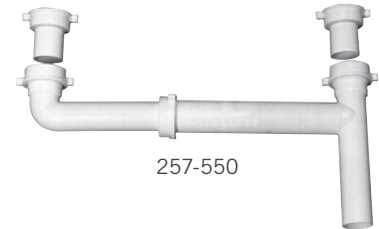

257-550

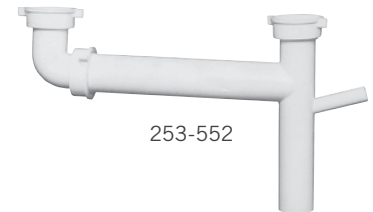

253-552

Item No	Color	"Y" Size	Pkg	Min Qty	Case Qty	List Price
DIRECT CONNECT						
253-550	White	—	B	25	25	5.95 EA
253-550B	Black	—	B	25	25	5.99 EA
UNIVERSAL						
257-550	White	—	B	25	25	6.94 EA
257-550B	Black	—	B	25	25	6.87 EA
WYE BRANCH – DIRECT CONNECT						
253-552	White	1/2"	B	15	15	7.43 EA
253-552B	Black	1/2"	B	15	15	7.46 EA
253-553	White	3/4"	B	15	15	7.47 EA

Center Outlet Waste

Universal

- 16" baffle tee
- Slip joint with two direct connect adapters
- White polypropylene

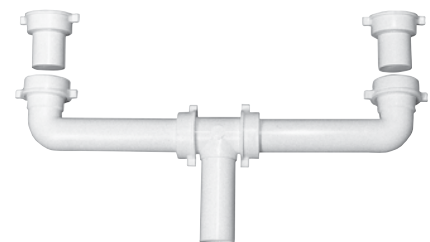

258-160

Item No	Description	Pkg	Min Qty	Case Qty	List Price
258-160	Universal center outlet waste	B	25	25	7.43 EA

PLUMBING

GAS

TOOLS

APPENDIX

PLUMBING

GAS

TOOLS

APPENDIX

Poly Sink Tailpiece

Single Flange or Double Flanged

- Available in white or black polypropylene

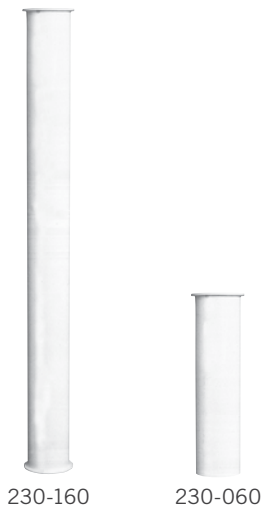

Item No	Dimensions	Color	Pkg	Min Qty	Case Qty	List Price
230-040	1½" × 4" flanged one end	white	B	25	25	0.95 EA
230-040B	1½" × 4" flanged one end	black	B	25	25	0.90 EA
230-060	1½" × 6" flanged one end	white	B	25	25	0.90 EA
230-080	1½" × 8" flanged one end	white	B	25	25	1.15 EA
230-120	1½" × 12" flanged one end	white	B	25	25	1.80 EA
230-160	1½" × 16" double flanged	white	B	25	25	3.10 EA
230-160B	1½" × 16" double flanged	black	B	25	25	3.10 EA

Extension Tube

Slip Joint or Solvent Weld

- Available in white or black polypropylene and white PVC

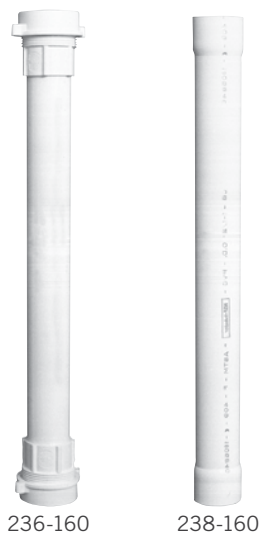

Item No	Dimensions	Connection	Material	Pkg	Min Qty	Case Qty	List Price
236-060	1½" × 6"	slip joint	white polypro	B	25	25	2.00 EA
236-080	1½" × 8"	slip joint	white polypro	B	25	25	2.10 EA
236-120	1½" × 12"	slip joint	white polypro	B	25	25	2.40 EA
236-160	1½" × 16"	double slip joint	white polypro	B	25	25	3.80 EA
236-160B	1½" × 16"	double slip joint	black polypro	B	25	25	3.98 EA
238-120	1½" × 12"	solvent weld	white PVC	B	25	25	2.75 EA
238-160	1½" × 16"	double solvent weld	white PVC	B	25	25	3.90 EA

Slip Nut

- Rough Brass
- Chrome-Plated Brass
- Chrome-Plated Zinc
- White Poly

Item No	Size	Material	Finish	Pkg	Min Qty	Case Qty	List Price
980-5	1¼" × 1¼"	solid brass	chrome plated	B	100	100	1.68 EA
980-6	1½" × 1½"	solid brass	chrome plated	B	100	100	1.95 EA
980-8	1½" × 1¼"	solid brass	chrome plated	B	100	100	2.16 EA
981-5	1¼" × 1¼"	solid brass	rough brass	B	100	100	1.62 EA
981-6	1½" × 1½"	solid brass	rough brass	B	100	100	1.64 EA
985-5	1¼" × 1¼"	zinc	chrome plated	B	100	100	0.67 EA
985-6	1½" × 1½"	zinc	chrome plated	B	100	100	1.05 EA
985-8	1½" × 1¼"	zinc	chrome plated	B	100	100	1.50 EA
986-6	1½" × 1½"	zinc	brass plated	B	100	100	0.67 EA
988-6	1½" × 1½"	polypro	white	B	100	100	0.33 EA



980-5



985-5



988-6

Tailpiece & Slip Washer

- Cloth-Inserted Rubber
- Rubber
- Polyethylene

Item No	Description	Material	Pkg	Min Qty	Case Qty	List Price
990-7	1½" cloth-inserted tailpiece washer	C.I. rubber	B	100	1000	0.36 EA
991-6	1½" flanged tailpiece washer	poly	B	100	1000	0.18 EA
995-5	1¼" × 1¼" slip washer	rubber	B	100	1000	0.25 EA
995-6	1½" × 1½" slip washer	rubber	B	100	1000	0.22 EA
995-8	1½" × 1¼" slip washer	rubber	B	100	1000	0.31 EA
996-6	1½" × 1½" slip washer, beveled	poly	B	100	1000	0.17 EA
996-8	1½" × 1¼" slip washer, beveled	poly	B	100	1000	0.20 EA
JOB PACK						
990-20385	1½" cloth-inserted tailpiece washer, job pack	C.I. rubber	B	25	300	0.39 EA
995-20320	1¼" square-cut slip washer, job pack	rubber	B	25	200	0.27 EA
995-20330	1½" square-cut slip washer, job pack	rubber	B	25	200	0.40 EA
995-20335	1½" × 1¼" square-cut slip washer, job pack	rubber	B	25	200	0.25 EA
995-20340	2" square-cut slip washer, job pack	rubber	B	25	200	0.17 EA



995-6



990-7



996-6



991-6



290-20300



290-20310



290-20313



290-20380

Drip-Free™ Washer Slip Joint Washer Combo Washer Tailpiece Washer

- Beveled design provides a better seal when used with standard slip nut
- Perfect washer for basket strainer installations

Item No	Description	Material	Color	Pkg	Min Qty	Case Qty	List Price
SLIP JOINT WASHERS							
290-20300	1¼" washer	soft PVC	white	B	25	300	0.48 EA
290-20301	1¼" washer	soft PVC	white	B	100	1000	0.44 EA
290-20310	1½" washer	soft PVC	black	B	25	300	0.48 EA
290-20311	1½" washer	soft PVC	black	B	100	1000	0.44 EA
COMBO WASHERS							
290-20313	1½" × 1¼" reducing slip joint washer	thermoplastic rubber	—	B	50	500	0.55 EA
TAILPIECE WASHERS							
290-20380	1½" washer	urethane	—	B	25	300	0.48 EA
290-20381	1½" washer	urethane	—	B	100	1000	0.44 EA

No-Putty Gasket™

- Replaces plumbers putty, won't dry out, stain or smudge
- Self adhesive eliminates mess
- Creates a tight seal on all finishes and materials
- Fits all standard drain attachments
- Stands up to the toughest commercial cleaners
- Allows you to pre-fab fixtures

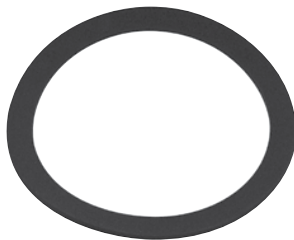

290-20320



290-20322



290-20324

Item No	Description	Pkg	Min Qty	Case Qty	List Price
290-20320	4¼" O.D. × 3⅜" I.D. gasket for kitchen basket strainer	B	100	1000	1.05 EA
290-20322	2" O.D. × 1½" I.D. gasket for lavatory drain, kitchen spray hose guide	B	100	1000	0.82 EA
290-20324	2¾" O.D. × 2" I.D. gasket for laundry sink, bar sink, tub drain	B	100	1000	0.82 EA
290-20320PK2	4¼" O.D. × 3⅜" I.D. gasket for kitchen basket strainer 4/bag, 12 bar-coded bags/box	C*	1	12	4.20 BG
290-20322PK2	2" O.D. × 1½" I.D. gasket for lavatory drain, kitchen spray hose guide, 4/bag, 12 bar-coded bags/box	C*	1	12	3.52 BG
290-20324PK2	2¾" O.D. × 2" I.D. gasket for laundry sink, bar sink, tub drain, 4/bag, 12 bar-coded bags/box	C*	1	12	3.52 BG

**Brass DWV Connector
Desanco Fitting**

- Solid brass body and nut
- Male and female connections

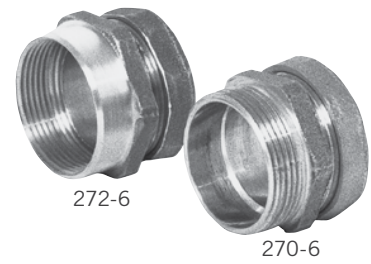

Item No	Description	Pkg	Min Qty	Case Qty	List Price
270-6	1½" tube × 1½" MIP connection—with brass ferrule	B	25	25	7.48 EA
272-6	1½" tube × 1½" FIP connection—with brass ferrule	B	25	25	7.88 EA

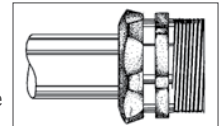

Connects tubular pipe to drainage pipe.

**DWV Slip Joint Adapter
Brass Marvel Thread**

- Sweat on to copper DWV pipe to make slip joint connections



Item No	Description	Pkg	Min Qty	Case Qty	List Price
274-5	1¼" female sweat × 1¼" slip joint thread	B	10	100	6.20 EA
274-6	1½" female sweat × 1½" slip joint thread	B	10	100	6.42 EA
274-7	2" female sweat × 2" slip joint thread	B	10	100	6.52 EA

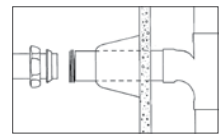

Slip joint thread for copper DWV pipe.

Industrial Sink Plug

- All brass industrial sink plug complete as shown with 1" tailpiece and brass stopper

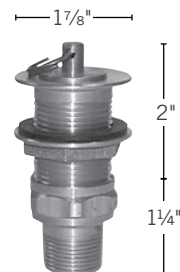

290-20200

Item No	Description	Pkg	Min Qty	Case Qty	List Price
290-20200	Brass sink plug with 1" tailpiece and brass stopper	B*	1	10	23.90 EA

Lavatory Drain

- Comes standard with brass nut and grid strainer
- 17 gauge brass tailpiece

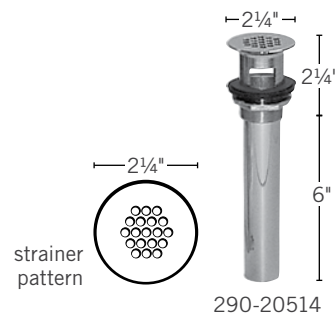

Item No	Description	Pkg	Min Qty	Case Qty	List Price
290-20514	6" tailpiece with grid strainer and brass lock nut	B*	1	12	21.75 EA

PLUMBING

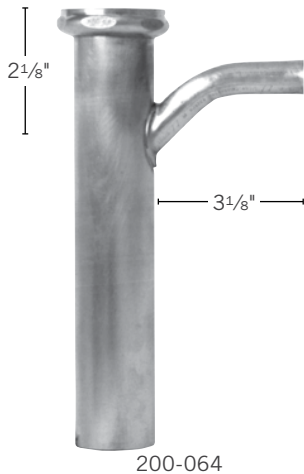

200-064

Long Branch™ Dishwasher Tailpiece

- Downward inlet eliminates splash up
- Faster installation – fewer pieces
- Long 1/2" nominal copper branch provides work space for easy sweat or hose clamp connection
- No connector kits needed
- Quality copper and brass construction

GAS

TOOLS

APPENDIX



204-068



206-064

Item No	Dimensions	Gauge	Nut Type	Branch Connection	Finish	Pkg	Min Qty	Case Qty	List Price
DIRECT CONNECTION									
200-062	1 1/2" x 6"	22	Zinc die cast	1/2" CTS	unfinished	B	25	25	10.60 EA
200-064	1 1/2" x 6"	22	Solid brass	1/2" CTS	unfinished	B	25	25	11.21 EA
200-066	1 1/2" x 6"	22	Solid brass	1/2" CTS	chrome plated	B	25	25	14.25 EA
200-082	1 1/2" x 8"	22	Zinc die cast	1/2" CTS	unfinished	B	25	25	11.19 EA
200-084	1 1/2" x 8"	22	Solid brass	1/2" CTS	unfinished	B	25	25	13.19 EA
200-122	1 1/2" x 12"	22	Zinc die cast	1/2" CTS	unfinished	B	25	25	14.77 EA
200-124	1 1/2" x 12"	22	Solid brass	1/2" CTS	unfinished	B	25	25	15.38 EA
200-124PK	1 1/2" x 12"	22	Solid brass	1/2" CTS	unfinished	C*	25	25	15.59 EA
FINE THREAD CONNECTION									
204-068	1 1/2" x 6"	20	—	1/2" CTS	chrome plated	B	25	25	16.00 EA
SLIP JOINT CONNECTION									
206-064	1 1/2" x 6"	22	Solid brass	1/2" CTS	unfinished	B	25	25	13.23 EA
206-066	1 1/2" x 6"	22	Solid brass	1/2" CTS	chrome plated	B	25	25	16.89 EA
206-084	1 1/2" x 8"	22	Solid brass	1/2" CTS	unfinished	B	25	25	14.26 EA

Dishwasher Tailpiece

- 1½" tube body – 22 gauge brass
- 7/8" O.D. copper branch

Item No	Dimensions	Nut Type	Branch Connection	Finish	Pkg	Min Qty	Case Qty	List Price
DIRECT CONNECT								
210-064	1½" × 6"	Solid brass	7/8" O.D.	Unfinished	B	25	25	11.74 EA
210-066	1½" × 6"	Solid brass	7/8" O.D.	Chrome plated	B	25	25	15.52 EA
210-084	1½" × 8"	Solid brass	7/8" O.D.	Unfinished	B	25	25	13.11 EA
210-086	1½" × 8"	Solid brass	7/8" O.D.	Chrome plated	B	25	25	16.53 EA
210-122	1½" × 12"	Zinc die cast	7/8" O.D.	Unfinished	B	25	25	15.20 EA
SLIP JOINT CONNECTION								
216-084	1½" × 8"	Solid brass	7/8" O.D.	Unfinished	B	25	25	14.23 EA
216-086	1½" × 8"	Solid brass	7/8" O.D.	Chrome plated	B	25	25	17.85 EA



Major Tee™ Brass Condensate Tailpiece

- 1¼" tube body – 20 gauge
- Branch is higher than standard tailpieces – keeps drain line high and out of sight
- Improves looks and adds storage space
- Eliminates extension tailpiece

Item No	Dimensions	Tubular Connection	Branch Connection	Finish	Pkg	Min Qty	Case Qty	List Price
213-067	1¼" × 6"	Fine thread	¾" MIPv	Unfinished	B	25	25	14.61 EA
213-069	1¼" × 6"	Fine thread	7/8" O.D.	Unfinished	B	25	25	11.12 EA

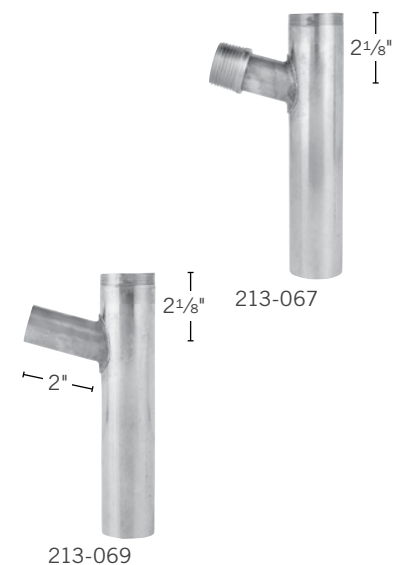

Lavatory Branch Tailpiece

- For condensate drain
- 1¼" tubular brass body
- 7/8" O.D. copper branch

Item No	Dimensions	Gauge	Tubular Connection	Finish	Pkg	Min Qty	Case Qty	List Price
213-060	1¼" × 6"	20	Fine thread	Unfinished	B	25	25	11.24 EA
213-061	1¼" × 6"	20	Fine thread × fine thread	Unfinished	B	25	25	12.79 EA
213-068	1¼" × 6"	20	Fine thread	Chrome plated	B	25	25	14.87 EA
215-064	1¼" × 6"	22	Slip joint	Unfinished	B	25	25	12.47 EA
215-066	1¼" × 6"	22	Slip joint	Chrome plated	B	25	25	16.14 EA



PLUMBING

GAS

TOOLS

APPENDIX



220-168

Brass Sink Tailpiece Single or Double Flange

- 22 gauge
- 1½" tube body

Item No	Dimensions	Finish	Pkg	Min Qty	Case Qty	List Price
220-040	1½" × 4"	Unfinished	B	50	50	4.06 EA
220-048	1½" × 4"	Chrome	B	48	48	5.66 EA
220-068	1½" × 6"	Chrome	B	24	24	6.31 EA
220-088	1½" × 8"	Chrome	B	24	24	7.73 EA
220-120	1½" × 12"	Unfinished	B	25	25	8.97 EA
220-128	1½" × 12"	Chrome	B	24	24	10.96 EA
220-168	1½" × 12" – double flange	Chrome	B	24	24	15.15 EA



223-128

Brass Threaded Tube–T.B.E.

- 20 gauge
- Fine threads on both ends

Item No	Dimensions	Finish	Pkg	Min Qty	Case Qty	List Price
223-128	1¼" × 12"	Satin	B	24	24	14.19 EA
224-128	1½" × 12"	Satin	B	24	24	16.78 EA

Slip Joint Extension Tube

- 22 gauge brass
- Die cast chrome nut with poly washer



226-068

Item No	Dimensions	Pkg	Min Qty	Case Qty	List Price
225-068	1¼" × 6"	B	24	24	10.74 EA
225-088	1¼" × 8"	B	24	24	11.56 EA
225-128	1¼" × 12"	B	24	24	14.77 EA
226-068	1½" × 6"	B	24	24	11.19 EA
226-088	1½" × 8"	B	24	24	12.77 EA
226-128	1½" × 12"	B	24	24	16.36 EA

Notes

PLUMBING
GAS
TOOLS
APPENDIX

GAS SPECIALTY

61 LOG LIGHTER PRODUCTS



www.goTomahawk.com



LOG LIGHTER PRODUCTS

HEARTHMASTER™ & ACCESSORIES	63
GAS BALL VALVE	67
GAS OX BOX™	67



Important Note

Gas Valve Deep Set Installations

- Alignment bushings are **REQUIRED*** for installations where valve is set in the wall, and flange is not directly connected to the valve.
- Measure distance from male threads of the valve to finished wall (or where finished wall will be) and subtract 1/2". This distance will determine the length of the 3/4" male thread steel pipe nipple (not included).
- Install a 3/4" female thread steel coupling (not included) on to one end of male thread steel pipe nipple. Install alignment bushings over the male (non-socket) end of the stem extension. Position one bushing against socket of stem extension, and the other bushing 1" from end of pipe nipple.
- If necessary, cut the stem extension flush with the end of the male thread steel pipe nipple. After wall is finished, insert the flange through the wall and thread on to pipe nipple. Tighten flange to the wall.
- Alignment bushings are included with all Sioux Chief stem extensions.

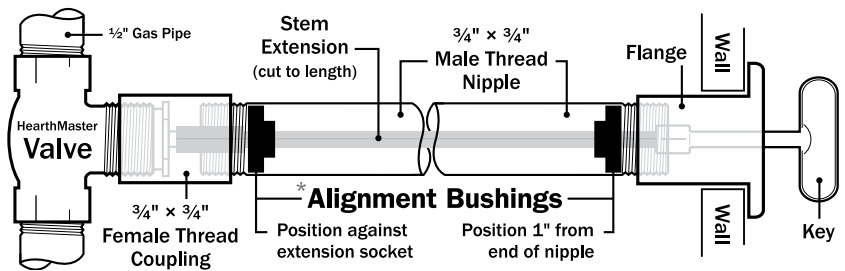

Temperature Ratings of HearthMaster Log Lighter Valves:

Minimum: 32°F / 0°C
 Maximum: 125°F / 51.6°C

HearthMaster™

Log Lighter Kits

- Angle and straight ball valve kits
- Log lighter bar, valve, flange and key – everything you need for installation in one convenient box
- Quarter-turn style ball valves
- Log lighter bars available in two or three FIP inlets
- Each chrome-plated component is individually bagged
- Our kits can be customized to fit the specific needs of most any job
- Log lighter bar is for NATURAL GAS ONLY

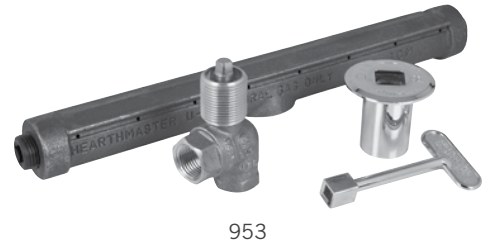

PLUMBING

GAS

TOOLS

APPENDIX

Item No	Description	Finish	Pkg	Min Qty	Case Qty	List Price
ANGLE BALL VALVE KITS						
953	3 FIP inlets, 16 flame outlets	chrome-plated flange, 3¾" cast zinc key	B*	1	6	32.01 EA
953-12	2 FIP inlets, 16 flame outlets	chrome-plated flange, 3¾" cast zinc key	B*	1	6	31.44 EA
STRAIGHT BALL VALVE KITS						
955	3 FIP inlets, 16 flame outlets	chrome-plated flange, 3¾" cast zinc key	B*	1	6	32.01 EA
955-12	2 FIP inlets, 16 flame outlets	chrome-plated flange, 3¾" cast zinc key	B*	1	6	31.44 EA



Log Lighter

PLUMBING



940-10



940-10PK1

GAS

TOOLS

APPENDIX

HearthMaster™

Log Lighter Bar

- 90,000 BTU/hour at ½ PSI (16 outlet model)
- Durable cast iron bars for NATURAL GAS ONLY
- Ash shield prevents ash and other debris from clogging flame outlets. To install upright, be sure the ash shield slopes downward. The words “HEARTHMASTER” and “NATURAL GAS ONLY” will read upright

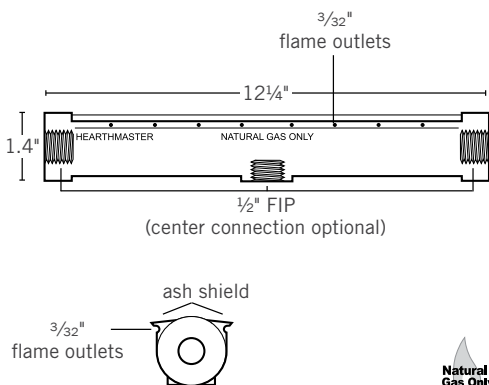

Item No	Description	Pkg	Min Qty	Case Qty	List Price
LOG LIGHTER BAR - 3 FIP INLETS					
940-10	16 flame outlets (8 per side)	B	6	6	13.22 EA
940-11	8 flame outlets (one side)	B	6	6	13.22 EA
940-10PK1	16 flame outlets (8 per side)	C*	1	10	14.78 EA
LOG LIGHTER BAR - 2 FIP INLETS					
940-12	16 flame outlets (8 per side)	B	6	6	13.12 EA
940-13	8 flame outlets (one side)	B	6	6	13.12 EA

HearthMaster™

Gas Ball Valve

- ¼-turn angle or ¼-turn straight ball valves
- Cast brass bodies with P.T.F.E. seats
- Available in bulk or with flange and key included
- ½" FIP × ½" FIP with ¾" NPSM flange thread
952: 150,000 BTU/hr @ ½ PSI
954: 350,000 BTU/hr @ ½ PSI
- For use with both natural gas and LP gas
- Manufactured in compliance with ANSI Z21.15b-2006

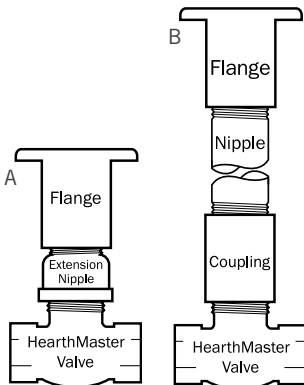

When valve-to-flange connections need extending, use our 948-EX extension piece (A), or for custom extensions, use a ¾" IPS coupling and nipple (B).

Temperature Ratings of HearthMaster Log Lighter Valves:

Minimum: 32°F / 0°C

Maximum: 125°F / 51.6°C

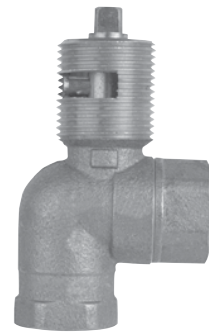

952

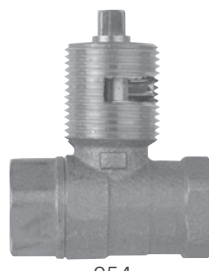

954



954-PK1

Item No	Description	Pkg	Min Qty	Case Qty	List Price
ANGLE BALL VALVE					
952	Bagged kit: valve, chrome-plated flange, 949 key	B	1	24	21.66 EA
952-P	Bagged kit: valve, polished brass flange, 949-P key	B	1	6	24.22 EA
952-V	Bulk: angle ball valve only	B	1	12	13.36 EA
952-PK1	Kit: valve, chrome-plated flange, 949 key	C*	1	6	23.37 EA
952-PPK1	Kit: valve, polished brass flange, 949-P key	C*	1	6	25.82 EA
STRAIGHT BALL VALVE					
954	Bagged kit: valve, chrome-plated flange, 949 key	B	1	24	20.75 EA
954-P	Bagged kit: valve, polished brass flange, 949-P key	B	1	6	23.85 EA
954-V	Bulk: straight ball valve only	B	1	12	12.87 EA
954-PK1	Kit: valve, chrome-plated flange, 949 key	C*	1	6	24.11 EA
954-PPK1	Kit: valve, polished brass flange, 949-P key	C*	1	6	25.22 EA





948



949-F



948-EX



949-K09



949-P

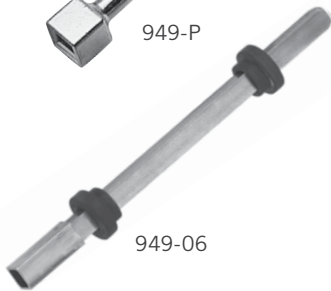

949-06

HearthMaster™

Log Lighter Accessories

- Flanges available in chrome-plated or polished brass finish
- Keys available with polished brass or zinc-coated finish
- Longer keys and stem extensions available for applications when the valve must be installed too deep in the wall or floor for standard keys

948-EX (PVC) extension is perfect when valve/flange connections need to be extended. Extends (A) to between 5⁵/₈" and 6³/₁₆".

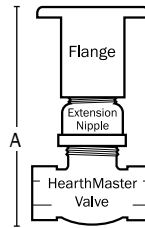

Adapter/key combo tool enables fast, easy installation or replacement of flanges without scratching.

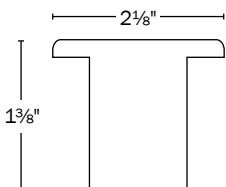
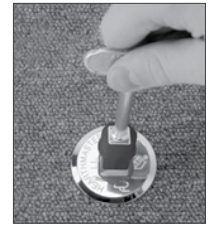

Item No	Description	Pkg	Min Qty	Case Qty	List Price
FLANGE					
948	Chrome plated	B	12	12	4.49 EA
948-P	Polished brass	B	1	12	5.09 EA
948-EX	Flange extension: 3/4" FIP x 3/4" MIP x 1.58" long, PVC	B	12	120	2.02 EA
949-F	Flange Installation Tool, includes key	B	1	25	3.52 EA
948PK2	Chrome plated, 1/bag	C*	10	10	5.56 EA
948-PPK2	Polished brass, 1/bag	C*	1	10	6.46 EA
KEY					
949	5/16" x 1/4" dual socket, 3 3/4" long, chrome	B	12	120	1.58 EA
949-P	5/16" x 1/4" dual socket, 3 3/4" long, polished brass	B	1	12	2.66 EA
949-K09	5/16" x 1/4" dual socket, 9 1/2" long, cast zinc	B	1	1	3.94 EA
949-K09P	5/16" x 1/4" dual socket, 9 1/2" long, polished brass	B	1	1	6.36 EA
949-K12	5/16" x 1/4" dual socket, 12" long, cast zinc	B	1	1	6.12 EA
949-CP	5/16" socket, 2 7/8" long, chrome, 1/bag	B*	12	120	2.47 EA
949-1PK2	1/4" socket, 2 7/8" long, cast zinc, 1/bag	C*	1	10	1.61 EA
949PK2	5/16" socket, 2 7/8" long, cast zinc, 1/bag	C*	1	10	2.15 EA
949-PPK2	5/16" socket, 2 7/8" long, polished brass, 1/bag	C*	1	10	3.22 EA
949-K09PK2	5/16" socket, 9 1/2" long, cast zinc, 1/bag	C*	1	10	5.10 EA
949-K12PK2	5/16" socket, 12" long, cast zinc, 1/bag	C*	1	10	7.96 EA
STAINLESS STEEL STEM EXTENSION					
949-06	5/16" socket, 6" long, with alignment bushings	B	1	10	4.19 EA
949-10	5/16" socket, 10" long, with alignment bushings	B	1	50	4.80 EA
949-12	5/16" socket, 12" long, with alignment bushings	B	1	50	5.25 EA
949-21	5/16" socket, 21" long, with alignment bushings	B	1	50	7.24 EA
949-12PK2	5/16" socket, 12" long, 1/bag	C*	1	10	5.56 EA

Gas Ball Valve

- Solid brass body
- Teflon® packing and seats
- Complies with ANSI Z21.15 manual valve and AGA 3-88
- ¼-turn valve



108-13

Item No	Description	Pkg	Min Qty	Case Qty	List Price
108-12	½" FIP gas ball valve	B	12	144	8.22 EA
108-12PK	½" FIP gas ball valve	C*	12	12	10.61 EA
108-13	¾" FIP gas ball valve	B	12	72	11.64 EA
108-13PK	¾" FIP gas ball valve	C*	12	12	12.82 EA
108-14	1" FIP gas ball valve	B	6	60	23.94 EA

Excludes 1" model
 SPEC SHEET

Ox Box™

Gas Valve Outlet Box & Fire-Rated Gas Valve Outlet Box

Patent #7,360,553 & #7,735,511

- ¼-turn ball valve for easy, secure, accessible operation
- Box is available for ½" or ¾" iron-pipe applications or ½" CSST applications in both standard and fire-rated products
- Recessed box is made of high-impact ABS, providing the strongest finished installation for all gas appliance needs
- Valve has CSA certification to ANSI Z21.15-1997 / CGA 9.1-M97

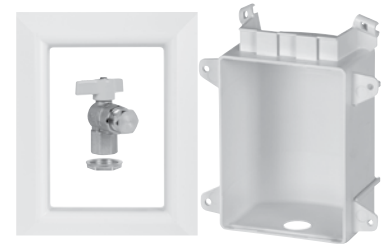

TH696-1020GF

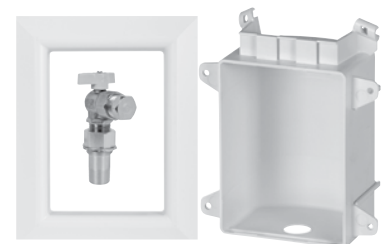

TH696-1021GF

Item No	Connection	Pkg	Min Qty	Case Qty	List Price
GAS OX BOX					
TH696-1021GF	½" NPT valve and adapter for iron pipe, bagged	B*	6	6	30.25 EA
TH696-1031GF	¾" NPT valve and adapter for iron pipe, bagged	B*	6	6	33.40 EA
TH696-1020GF	½" FIP valve for CSST connection, bagged	B*	6	6	27.75 EA
FIRE-RATED GAS OX BOX					
TH696R1021GF	½" NPT valve and adapter for iron pipe, bagged	B*	10	10	74.47 EA
TH696R1031GF	¾" NPT valve and adapter for iron pipe, bagged	B*	10	10	77.62 EA
TH696R1020GF	½" FIP valve for CSST connection, bagged	B*	10	10	71.97 EA



TOOLS

- 71 POWERPEX™ TOOLS
- 77 CUTTING DEVICES
- 83 BRUSHES & ABRASIVES
- 87 WRENCHES
- 91 OTHER TOOLS & ACCESSORIES



PowerPEX™ TOOLS

F1807 & F2159 72

F2080 74

FIT QUICK™ 76

OUR SPECIALTY///YOUR EDGE



305-40



305-23CPK



305-92PK



305-100PK1



305-95



305-41CKIT

PowerPEX™ Crimp Tools

Complete Line of F1807 Crimp Tool Options

- Steel or Composite handles
- Composite handles are strong and durable, yet lightweight
- Compact tools allow one-hand crimping
- Combo tool for the most common crimp connections and added cost savings
- Free Go/No-Go gauge provided with every model
- Also work on PB 1380 tube and fittings

PLUMBING

GAS

TOOLS

APPENDIX

Item No	Description	Length	Pkg	Min Qty	Case Qty	List Price
COMPOSITE HANDLE						
NEW 305-20CPK	1/2"	14"	B*	1	10	170.00 EA
NEW 305-30CPK	3/4"	14"	B*	1	10	170.00 EA
305-23CPK	1/2" over 3/4" combo	14"	B*	1	10	170.00 EA
305-40CPK	1"	14"	B*	1	10	180.00 EA
COMPOSITE HANDLE KIT						
NEW 305-41CKIT	3/8", 1/2", 3/4" & 1"	16"	B*	1	10	258.88 EA
COMPACT OFFSET WITH STEEL HANDLE						
305-91PK	3/8" with carrying case	11"	B*	1	12	130.00 EA
305-92PK	1/2" with carrying case	11"	B*	1	10	130.00 EA
305-93PK	3/4" with carrying case	11.5"	B*	1	10	130.00 EA
MULTI-SIZE BLOCK STYLE						
305-100PK1	3/8"-1" economical model	—	C*	1	10	45.13 EA
GO/NO-GO GAUGE						
305-95	Gauge 3/8", 1/2", 3/4" & 1"	—	C*	12	12	6.96 EA

PowerPEX™ Crimp Ring Removal Tool F1807 PEX Tool

- Two cuts on copper ring allows user to reclaim fitting
- Cutting blade only penetrates the copper ring and pipe
- Suitable for use on ½" through 1" PEX pipe sizes
- Allows fitting recovery without damaging the sealing surfaces of the fitting
- Do not use on Copper F1807 PEX or AccuCrimp fittings



305-99

Item No	Description	Pkg	Min Qty	Case Qty	List Price
305-99	Crimp ring removal tool	B*	1	10	58.00 EA

PowerPEX™ V-Sleeve™ Stainless Steel PEX Compression Tools

Patent Pending

- Exclusively for installing Sioux Chief's V-Sleeve stainless steel PEX compression system
- Steel handle



Unique jaw design for stainless steel sleeves reduces chances of confusion with common *crimp ring* tools.



305-83TX

305-92TX

Item No	Description	Pkg	Min Qty	Case Qty	List Price
305-82TX	½" press tool	B*	1	10	220.00 EA
305-83TX	¾" press tool	B*	1	10	220.00 EA
305-84TX	1" press tool	B*	1	10	270.00 EA
305-85TX	Go/No-Go gauge ½", ¾" & 1"	B*	1	12	9.15 EA
305-92TX	½" offset tool	B*	1	10	185.00 EA

NEW



305-A139592-0

NEW PowerPEX™
Expander Tool
F2080 PEX Tool

• Expander heads sold separately

Item No	Description	Pkg	Min Qty	Case Qty	List Price
305-A139592-0	F2080 Pipe Expander Tool	B	1	1	300.94 EA



305-A261866-2

NEW PowerPEX™
Expander Head
F2080 PEX Tool



305-A235417-5

Item No	Description	Pkg	Min Qty	Case Qty	List Price
305-A261856-1	3/8"	B	1	1	196.11 EA
305-A261866-2	1/2"	B	1	1	168.98 EA
305-A261886-3	3/4"	B	1	1	171.93 EA
305-A261896-4	1"	B	1	1	176.84 EA
305-A235417-5	1 1/4"	B	1	1	191.58 EA
305-A235427-6	1 1/2" for H2 Tool	B	1	1	290.11 EA
305-A235437-7	2" for H2 Tool	B	1	1	317.34 EA



305-A243737

NEW PowerPEX™
Compression Tool
F2080 PEX Tool

• Compression jaw set sold separately

Item No	Description	Pkg	Min Qty	Case Qty	List Price
305-A243737	1/2" - 1 1/4"	B	1	1	572.92 EA

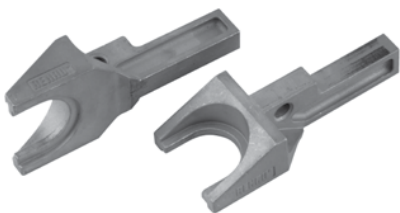

305-A243787

NEW PowerPEX™
Compression Jaw Set
F2080 PEX Tool

Item No	Description	Pkg	Min Qty	Case Qty	List Price
305-A243767	3/8", 1/2", 5/8", 3/4" Jaw (Set), 4-in-1	B	1	1	123.79 EA
305-A243787	1" Jaw (Set)	B	1	1	109.94 EA
305-A243797	1 1/4" Jaw (Set)	B	1	1	112.08 EA
305-A137964	1 1/2" Jaw (Set) for H2 Tool	B	1	1	1,237.00 EA
305-A235497	2" Jaw (Set) for H2 Tool	B	1	1	1,317.79 EA

PowerPEX™

NEW Combo Tool: Compression & Expansion
F2080 PEX Tool

- Expander heads sold separately
- Use to expand 3/8" – 1" PEX tube
- Use to compress 3/8" – 1/2" PEX tube only



305-A243107

Item No	Description	Pkg	Min Qty	Case Qty	List Price
305-A243107	3/8" – 1"	B	1	1	423.41 EA

PowerPEX™

NEW Tool Kit
F2080 PEX Tool

- Standard Kit:
 - One 305-A139592-0, pipe expander tool
 - One 305-A261866-2, 1/2" expander head
 - One 305-A261886-3, 3/4" expander head
 - One 305-A243107, 1/2" & 3/8" compression/expansion tool
 - One 305-A243737, compression tool
 - One 305-A243767, 4-in-1 compression jaw set
 - One 304-12, pipe cutter
 - One tool box
- Basic Kit:
 - One 305-A139592-0, pipe expander tool
 - One 305-A261866-2, 1/2" expander head
 - One 305-A261886-3, 3/4" expander head
 - One 305-A243737, compression tool
 - One 305-A243767, 4-in-1 compression jaw set
 - One 304-12, pipe cutter
 - One tool box
- Deluxe Kit:
 - One 305-A139592-0, pipe expander tool
 - One 305-A261866-2, 1/2" expander head
 - One 305-A261886-3, 3/4" expander head
 - One 305-A243107, 1/2" & 3/8" compression/expansion tool
 - One 305-A243737, compression tool
 - One 305-A243767, 4-in-1 compression jaw set
 - One 304-12, pipe cutter
 - One 304-11, ratchet pipe cutter
 - One 305-A261896-4, 1" expander head
 - One 305-A243787, 1" compression Jaw set



305-A261216
Standard



305-A261246
Basic



305-A261256
Deluxe

Item No	Description	Pkg	Min Qty	Case Qty	List Price
305-A261216	F2080 Standard Tool Kit	B	1	1	1,990.40 EA
305-A261246	F2080 Basic Tool Kit	B	1	1	1,374.81 EA
305-A261256	F2080 Deluxe Tool Kit	B	1	1	2,232.65 EA

PLUMBING

GAS

TOOLS

APPENDIX

PLUMBING

GAS

TOOLS

APPENDIX



305-A235407

NEW PowerPEX™
**H2 Hydraulic Tool and Head
 for Compression & Expansion
 F2080 PEX Tool**

Item No	Description	Pkg	Min Qty	Case Qty	List Price
305-A235407	F2080 H2 Hydraulic Tool Kit: 1½" & 2"	B	1	1	8,008.13 EA



305Q4

Fit Quick™ Disconnect Tool

- Quickly and easily disconnects push fittings
- 1¼" – 2" disconnect tools are unique to their sizes and come with special instructions on use

Item No	Description	Pkg	Min Qty	Case Qty	List Price
305Q2	½" disconnect tool	C*	1	24	1.74 EA
305Q3	¾" disconnect tool	C*	1	24	1.74 EA
305Q4	1" disconnect tool	C*	1	12	1.95 EA
305Q5	1¼" disconnect tool	B	1	1	19.25 EA
305Q6	1½" disconnect tool	B	1	10	20.50 EA
305Q7	2" disconnect tool	B	1	1	20.50 EA

CUTTING DEVICES

Tube Cutters	78
Deburring Tool	79
Utility Knife	79
Saws	80
Inside Pipe Cutters	81
Stud Punch	82



304-08

Plastic Tube Cutter

- Quickly cut PEX, PVC, CPVC and other poly pipe or non-metallic hose
- For 1¹/₈" O.D. tube or smaller

Item No	Description	Pkg	Min Qty	Case Qty	List Price
304-08	Plastic tube and hose cutter - 2 ¹ / ₄ " blade length	C*	12	72	16.70 EA
304-1	Stainless steel replacement blade for 304-08	B	1	50	5.50 EA
304-12	Plastic tube and hose cutter - 3 ¹ / ₄ " blade length	C*	1	12	16.70 EA
304-12B	Stainless steel replacement blade for 304-12	B	1	12	6.75 EA



304-11

Ratchet Tube Cutter

- For use with PVC and polyethylene piping
- Easy ratchet cutting action



305-A139092

Item No	Description	Pkg	Min Qty	Case Qty	List Price
304-11	Cuts 3/8" thru 1 ¹ / ₄ " diameter tube/pipe	C*	1	12	20.72 EA
305-A139092	Cuts 1 ¹ / ₄ " thru 2" diameter tube/pipe	B	1	10	235.00 EA
305-A139092B	Replacement blade	B	1	25	27.85 EA



304-20

Copper Tube Cutters

Mini Cutter

- 1/8"-5/8" capacity
- Large ribbed feed screw knob

Internal Adjustment Cutter

- 1/8"-1¹/₈" capacity
- Extra cutter wheel in body
- Body and knob made of lightweight aluminum
- Telescoping feed mechanism keeps turning radius constant

Zip Action Cutter

- 3/16"-1¹/₄" capacity
- Aluminum alloy die cast body with zip adjustable action
- Spare cutter wheel in knob



304-25



Built-in deburring tool.



304-30

Item No	Description	Pkg	Min Qty	Case Qty	List Price
304-20	Mini cutter	B*	1	24	7.50 EA
304-25	Internal adjustment cutter with deburring tool	B*	1	10	21.90 EA
304-30	Zip action cutter with deburring tool	B*	1	10	35.20 EA
304-32	Replacement wheel for 304-25/304-30	B*	1	20	3.95 EA

Deburring Tool

- Plastic body
- High carbon steel blade
- Blade storage in body



304-06

Item No	Description	Pkg	Min Qty	Case Qty	List Price
304-06	Deburring tool, includes one spare blade	B*	1	24	7.65 EA
304-6B	Replacement blades, 5 blades/bag	B*	1	50	10.00 EA

Utility Knife

- Uses standard double pointed blades



315-10

Item No	Description	Pkg	Min Qty	Case Qty	List Price
315-10	Utility knife with one blade	B	12	60	8.00 EA
315-1	Replacement blades, 5 blades/card	B*	10	100	1.45 EA

PLUMBING
GAS
TOOLS



300-12



300-20

Sawhorse™ Multi-Purpose Saw

- High-quality, hardened-steel blade remains sharp through thousands of cuts
- Perfect for plastic pipe, wood and many other materials
- 12" model has 13 teeth/inch for fine cutting. Teeth are on the nose for notching in tight areas and starting cuts in the middle of floor or wall
- 20" model has 10 teeth/inch for faster cutting
- Both include plastic teeth protector

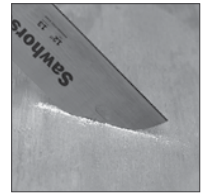

APPENDIX

Item No	Description	Pkg	Min Qty	Case Qty	List Price
300-12	12" with plastic teeth protector	B	12	12	16.10 EA
300-20	20" with plastic teeth protector	B	4	4	37.14 EA
300-12B	Replacement blade for 300-12	B	1	25	12.98 EA
300-20B	Replacement blade for 300-20	B	6	6	25.53 EA



301-062



301-065

Mini Hacksaw Pistol Grip & Standard

- Separate screw sets the 6" blade tension
- Good for fine work in small areas. Six inch steel blade cuts copper and brass tube, bolts, steel, wood and plaster
- Pistol Grip is easier to hold and grasp

Item No	Description	Pkg	Min Qty	Case Qty	List Price
301-062	Deluxe pistol grip, 6" blade	B	10	10	12.97 EA
301-065	Standard D-type, 6" blade	B	20	20	2.71 EA
301-061	6" carbon steel replacement blade 32 teeth/inch, pin ends	B	5	100	0.72 EA

Wire Cable Saw

- Cuts PVC pipe in tight spaces
- Disposable, good for approximately 40 cuts

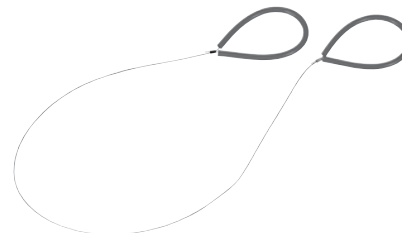

390-50105

Item No	Description	Pkg	Min Qty	Case Qty	List Price
390-50105	Wire cable saw for plastic pipe	B*	1	25	3.10 EA

Inside Pipe Cutter

- Steel blade for plastic pipe
- Abrasive disc for plastic or steel pipe

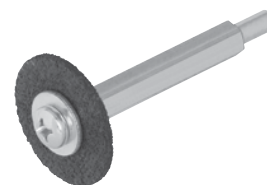

390-50153

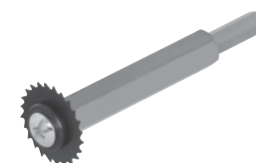

390-50163

Item No	Description	Pkg	Min Qty	Case Qty	List Price
390-50153	Inside pipe cutter with two 1 ⁹ / ₁₆ " abrasive discs	B*	1	100	9.00 EA
390-50154	Replacement kit: 3 discs, 1 bolt, 1 washer	B*	1	100	7.80 EA
NEW 390-50155	Replacement discs only, 10/bg	B	1	5	24.50 BG
390-50163	Inside pipe cutter with 1 ¹ / ₄ " steel blade	B*	1	10	14.10 EA
390-50164	1 ¹ / ₄ " hardened steel replacement blade	B*	1	100	3.20 EA

BRUSHES & ABRASIVES

BRUSHES 84

ABRASIVES 86

OUR SPECIALTY///YOUR EDGE

PLUMBING

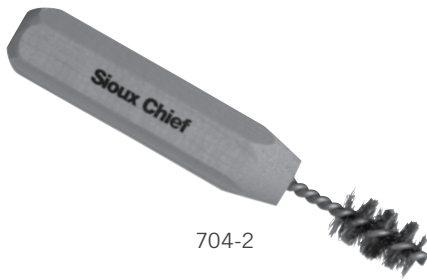

704-2

GAS



705-3

TOOLS

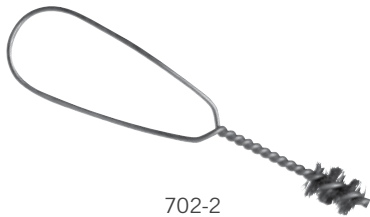

702-2

APPENDIX



706-4

Fitting Brushes

Deluxe Wood Handle

- Solid wood, screwdriver type handle is easy to hold and turn
- Stainless steel bristles

Plastic Handle

- Carbon or stainless steel bristles

Open-Loop Handle

- Carbon or stainless steel bristles

Drill Attachment

- Stem fits all power drill chucks
- Carbon or stainless steel bristles

Item No	Description	Bristles	Pkg	Min Qty	Case Qty	List Price
DELUXE WOOD HANDLE						
704-2	1/2" CTS	stainless steel	B	12	72	1.91 EA
704-3	3/4" CTS	stainless steel	B	12	72	1.99 EA
704-4	1" CTS	stainless steel	B	12	72	2.22 EA
PLASTIC HANDLE						
700-0	1/4" CTS	carbon steel	B	12	120	1.83 EA
700-1	3/8" CTS	carbon steel	B	12	120	1.83 EA
700-2	1/2" CTS	carbon steel	B	12	120	1.83 EA
700-3	3/4" CTS	carbon steel	B	12	120	1.90 EA
700-4	1" CTS	carbon steel	B	12	120	2.08 EA
700-5	1 1/4" CTS	carbon steel	B	6	60	2.26 EA
700-6	1 1/2" CTS	carbon steel	B	6	60	2.47 EA
700-7	2" CTS	carbon steel	B	6	60	2.87 EA
705-2	1/2" CTS	stainless steel	B	12	120	4.80 EA
705-3	3/4" CTS	stainless steel	B	12	120	4.98 EA
705-4	1" CTS	stainless steel	B	12	120	5.05 EA
OPEN-LOOP HANDLE						
702-2	1/2" CTS	carbon steel	B	24	240	1.10 EA
702-3	3/4" CTS	carbon steel	B	24	240	1.14 EA
702-4	1" CTS	carbon steel	B	24	240	1.30 EA
703-2	1/2" CTS	stainless steel	B	24	240	1.26 EA
703-3	3/4" CTS	stainless steel	B	24	240	1.29 EA
703-4	1" CTS	stainless steel	B	24	240	1.47 EA
703-5	1 1/4" CTS	stainless steel	B	12	120	2.26 EA
703-6	1 1/2" CTS	stainless steel	B	6	60	2.47 EA
703-7	2" CTS	stainless steel	B	6	60	2.79 EA
DRILL ATTACHMENT						
706-2	1/2" CTS	carbon steel	B	6	60	1.10 EA
706-3	3/4" CTS	carbon steel	B	6	60	1.15 EA
706-4	1" CTS	carbon steel	B	6	60	1.30 EA
707-2	1/2" CTS	stainless steel	B	6	60	1.20 EA
707-3	3/4" CTS	stainless steel	B	6	60	1.25 EA
707-4	1" CTS	stainless steel	B	6	60	1.37 EA

Acid Brush

- Metal handle
- 100% horse hair bristles
- Available in 3/8" or 1/2" wide

Item No	Description	Pkg	Min Qty	Case Qty	List Price
771	# 1 metal handle acid brush: 3/8" wide, 6" long, 100% horse hair, 144/bag	B	1	12	21.25 GR
772	# 2 metal handle acid brush: 1/2" wide, 6" long, 100% horse hair, 144/bag	B	1	12	26.85 GR



771

Pipe Dope/Cement Brush

- Wood handle
- Horse hair or natural bristles
- Available from 3/4" to 2" widths

Item No	Description	Bristles	Pkg	Min Qty	Case Qty	List Price
773	3/4" wide	Horse hair	B	36	360	1.30 EA
774	1" wide	Natural	B	36	36	2.02 EA
776	1 1/2" wide	Natural	B	24	24	2.97 EA
777	2" wide	Natural	B	24	24	3.32 EA

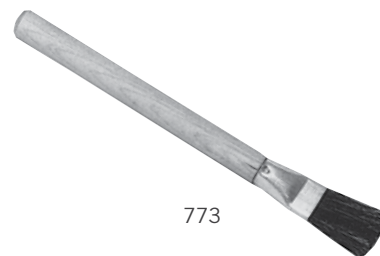

773



777

Safe-Flame™

Flame Protection Pad

- Absorbs heat
- No smoke or odor
- Non asbestos
- 9" x 12" blanket

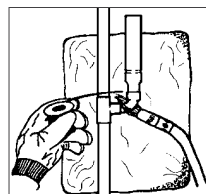

Use when soldering or brazing near wood, paint or other flammable materials.



390-50160

Item No	Description	Pkg	Min Qty	Case Qty	List Price
390-50160	Flame protection blanket	B*	1	25	16.90 EA

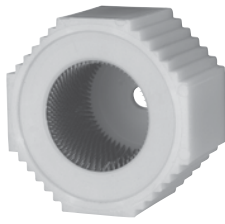

710-4

Tube O.D. Brush

- High impact, hex body for better grip
- Carbon steel bristles

Item No	Description	Pkg	Min Qty	Case Qty	List Price
710-2	1/2" CTS	B	6	120	4.10 EA
710-3	3/4" CTS	B	6	120	4.60 EA
710-4	1" CTS	B	6	120	5.21 EA

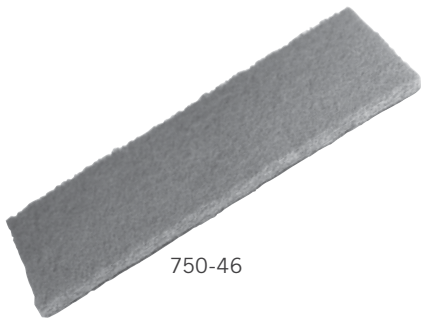

750-46

Copper Cleaning Pad

- Cleans copper tube and fittings for soldering
- Great general purpose cleaning pad
- Use wet or dry

Item No	Description	Pkg	Min Qty	Case Qty	List Price
750-46	4" x 6" x 1/4" fine grit, red nylon pad, 10 pads/bag	B	1	14	7.72 EA
750-69	6" x 9" x 1/4" fine grit, tight weave, red nylon pad, 5 pads/bag	B	1	12	6.55 EA
752-69	6" x 9" x 1/4" medium grit, loose weave, green nylon pad, 5 pads/bag	B	1	12	4.97 EA



730-10

Abrasive Mesh

- 180 grit open mesh is waterproof
- Rinse when mesh gets loaded with debris



740-10

Sand Cloth

- 120 grit brown cloth is water resistant



743-10

Wet-Proof Cloth

- 120 grit blue-green cloth is 100% waterproof
- Unaffected by water, cutting oils, grease, etc.

Item No	Description	Grit	Pkg	Min Qty	Case Qty	List Price
ABRASIVE MESH						
730-05	5 yard roll in dispenser box	180	B*	1	24	5.27 EA
730-10	10 yard roll in dispenser box	180	B*	1	24	8.82 EA
730-25	25 yard roll in dispenser box	180	B*	1	12	19.65 EA
SAND CLOTH						
740-02	2 yard roll in bag	120	B*	1	50	1.64 EA
740-05	5 yard roll in dispenser box	120	B*	1	24	2.89 EA
740-10	10 yard roll in dispenser box	120	B*	1	24	5.41 EA
740-25	25 yard roll in dispenser box	120	B*	1	12	12.05 EA
WET-PROOF CLOTH						
743-05	5 yard roll in dispenser box	120	B*	1	24	4.20 EA
743-10	10 yard roll in dispenser box	120	B*	1	24	7.49 EA
743-25	25 yard roll in dispenser box	120	B*	1	12	17.79 EA

WRENCHES

Slip Joint Pliers	88
Offset Ratchet Box Wrench	88
Teleopic Basin Wrench	88
Allen Wrench Set	89
Strap Wrench	89
Shower Arm Installation Tool	89
Plug Wrench	90
Faucet Seat Wrench	90
Socket Wrench Set	90
Water Heater Wrench	90

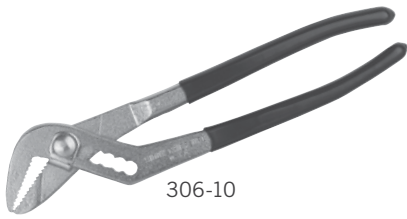

306-10

Slip Joint Pliers

Milled Jaw

- Nickel-plated finish with plastic grips
- Angle-nose pliers have Grip Tight clip

Item No	Description	Max. Opening	Pkg	Min Qty	Case Qty	List Price
306-10	10" angle-nose pliers	1½"	B*	10	50	21.50 EA



316-2

Offset Ratchet Box Wrench

- 25° offset angle
- Reach tight situations without scraping your knuckles
- Speed and convenience of ratcheting box wrench
- Reverse by flipping lever

Item No	Description	Pkg	Min Qty	Case Qty	List Price
316-1	¾" x 7/16" box wrench	C	1	12	5.45 EA
316-2	½" x 9/16" box wrench	C	1	12	7.61 EA



390-50197

Telescopic Basin Wrench

- Jaw capacity: ¾" – 1½"
- Nickel-plated finish for long life
- 6" long leverage bar
- Length adjusts to 9½", 12", 14" and 16½"

Item No	Description	Pkg	Min Qty	Case Qty	List Price
390-50197	Telescopic basin wrench	B*	1	20	18.75 EA

Allen Wrench Set

- Nine different hex key sizes



318-9

Item No	Description	Pkg	Min Qty	Case Qty	List Price
318-9	1/4" - 5/64" hex key set	B*	1	10	6.50 EA

Strap Wrench

- Reinforced rubber strap
- Works in tight areas
- Adjust to fit any irregular shape
- 8" handle

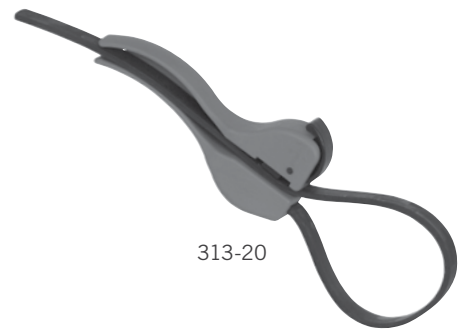

313-20

Item No	Description	Pkg	Min Qty	Case Qty	List Price
313-20	Strap wrench	B*	1	12	18.00 EA

Shower Arm Installation Tool

Patent # 6,460,432

- Easier shower arm installations
- Allows shower arm installation with no external damage
- Wrench locks into shower arm for secure, no slip installation
- Can be used on all brass shower arms
- Heavy-duty malleable iron wrench with galvanized finish

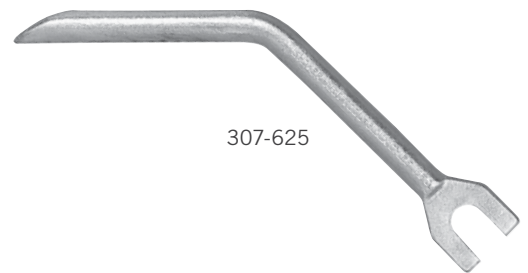

307-625



Related Product
Shower Arms

p 34

Item No	Description	Pkg	Min Qty	Case Qty	List Price
307-625	Shower Arm Installation Tool, individually bagged	B	1	6	7.55 EA

PLUMBING

GAS

TOOLS

APPENDIX

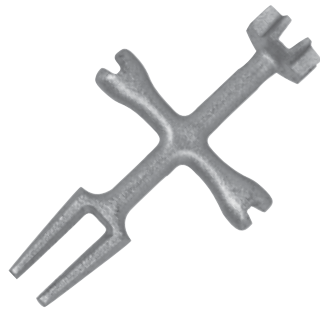

390-50198

P.O. Plug Wrench

- Malleable iron
- Holds P.O. plug and basket straight during installation

Item No	Description	Pkg	Min Qty	Case Qty	List Price
390-50198	Pop-up & overflow plug wrench	B*	1	20	7.15 EA



390-50133

Faucet Seat Wrench

- Ratchet wrench set has two square and one hex wrench plus a ratchet



390-50132



390-50130 comes in resealable case

Item No	Description	Pkg	Min Qty	Case Qty	List Price
390-50130	Ratchet wrench set	B*	1	25	25.50 EA
390-50132	Straight wrench tool	B*	1	12	6.20 EA
390-50133	Angle wrench tool	B*	1	12	8.40 EA



311-10

Socket Wrench Set for Tub/Shower Valves

- Each set includes the following wrenches:
 $2\frac{1}{32}'' \times 2\frac{7}{32}''$, $2\frac{9}{32}'' \times 3\frac{1}{32}''$, $1\frac{1}{32}'' \times 1\frac{3}{32}''$,
 $1\frac{5}{32}'' \times 1\frac{9}{32}''$, $1\frac{11}{32}'' \times 1\frac{7}{16}''$, and one 5" turning bar
- Wrenches are $4\frac{3}{8}''$ deep

Item No	Description	Pkg	Min Qty	Case Qty	List Price
311-10	Set with carrier handle	B*	1	5	15.25 EA

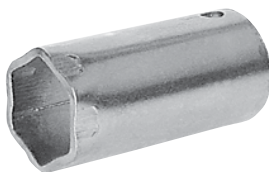

390-50185

Water Heater Element Wrench

- $1\frac{1}{2}''$ hex, heavy-duty plated steel with turning bar
- $\frac{1}{8}''$ wall thickness, $3\frac{3}{4}''$ long
- Hole is $1\frac{1}{32}''$ for leverage bar (not included)

Item No	Description	Pkg	Min Qty	Case Qty	List Price
390-50185	Water heater element wrench	B*	1	10	9.50 EA

PLUMBING

GAS

TOOLS

APPENDIX

OTHER TOOLS & ACCESSORIES

Tools	92
Lubricant	96
PTFE Packing Rope & Tape	96
Duct Tape	97
Cement Stop Leak	97
Oakum	97
Gloves	98
Shoe Covers & Dust Masks	99
Tie Down Strap	99
Buckets, Boxes & Hooks	100

PLUMBING

GAS

TOOLS

APPENDIX

6-in-1 Screwdriver

- Includes one dual ended slotted bit, one dual ended Phillips bit and one 5/16" x 1/4" nut driver shank
- Replacement bits available



314-12



314-10



314-20

Item No	Description	Pkg	Min Qty	Case Qty	List Price
314-10	Six-in-one screwdriver, red handle – display pack	B	12	12	8.50 EA
314-12	Six-in-one with easy grip rubber handle	C*	12	12	9.00 EA
314-20	Combo replacement bit pack, slotted and Phillips, 2 bits/bag	B	1	25	4.50 BG

Faucet Stem Key

- Fits: 1/4", 9/32", 5/16" and 11/32" faucet and sillcock stems



390-50134

Item No	Description	Pkg	Min Qty	Case Qty	List Price
390-50134	Four-way faucet stem key	B*	1	12	4.75 EA

Moen Cartridge Puller

- Removes Moen† #1200 and #1225 cartridges
- Includes adapter for Posi-temp valves



390-50128



Posi-temp adapter

Item No	Description	Pkg	Min Qty	Case Qty	List Price
390-50128	Puller for Moen†	B*	1	12	10.25 EA

† The part is not made by original manufacturer but manufactured to same specifications as original part.

Faucet Handle Puller

- Removes larger handles with longer adjustable puller arms
- One piece cast cross bar for strength and durability
- Puller features notches to ensure positive and equal positioning of puller arms on cross bar
- Alloy steel components

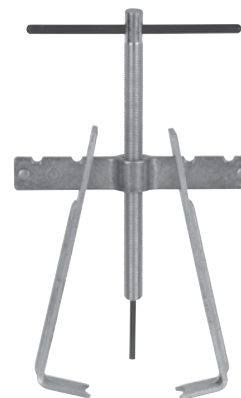

318-4

Item No	Description	Pkg	Min Qty	Case Qty	List Price
318-4	Faucet handle puller	B*	1	5	15.64 EA

Flaring Tool Deluxe "Papco" Style Tool

- Single-lap 45° flares thin wall tubing such as copper, brass or aluminum
- 3/16" O.D. to 5/8" O.D.

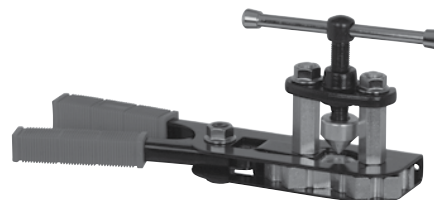

308-2

Item No	Description	Pkg	Min Qty	Case Qty	List Price
308-2	Deluxe flaring tool	B*	1	12	39.00 EA

O-Ring Pick

- Easy grip handle



390-50138

Item No	Description	Pkg	Min Qty	Case Qty	List Price
390-50138	Deluxe o-ring pick	C*	1	12	4.60 EA

PLUMBING

GAS

Flexible Grabber

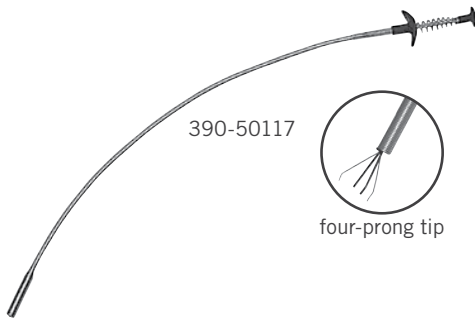

Item No	Description	Pkg	Min Qty	Case Qty	List Price
390-50117	23" flexible grabber	B*	1	25	3.00 EA

TOOLS

Inspection Mirror

- 1" x 2" oval mirror with angle ball joint
- Powerful long life magnetic tip
- Pocket clasp
- Extends 5 $\frac{1}{2}$ " – 18 $\frac{3}{4}$ "



Item No	Description	Pkg	Min Qty	Case Qty	List Price
390-50115	Extendable inspection mirror with magnetic tip	B*	1	24	9.75 EA

APPENDIX

Match Holder

- Extends 6" – 25"
- Pocket clasp



Item No	Description	Pkg	Min Qty	Case Qty	List Price
390-50110	Extendable match holder with pocket clasp	B*	1	25	7.65 EA

Levels

Surface

- Levels horizontal and vertical at the same time
- 1¾" O.D.

Torpedo

- Durable, 10" aluminum frame
- Strong magnetic holding power



310-10
Surface



310-12
Torpedo

Item No	Description	Pkg	Min Qty	Case Qty	List Price
310-10	Surface level	B*	1	24	3.00 EA
310-12	10" aluminum level, magnetic	B*	1	10	14.60 EA

Locking Tape Measure

- Heavy-duty 1" wide tape
- High-impact poly case with rubberized grips
- Thumb lock with power return
- Reinforced end catch
- Belt clip



310-05

Item No	Description	Pkg	Min Qty	Case Qty	List Price
310-05	25' locking tape measure	B*	1	12	11.00 EA

Plunger

- 312-2 has a funnel-shaped cap that is retractable for use in flat sinks
- 390-50148 has an extra large bulb for extra thrust

Item No	Description	Pkg	Min Qty	Case Qty	List Price
312-2	Funnel type rubber plunger - 20" handle	B	1	12	7.65 EA
390-50148	Bulb type rubber plunger - 18" handle	B*	1	12	18.25 EA



312-2



390-50148

PLUMBING

GAS

TOOLS

APPENDIX

Silicone Lubricant for O-Rings & Valve Stems

- FDA approved
- Does not deteriorate o-rings and other EPDM, buna or rubber seats/seals
- Temperature range -40°F to 400°F



963-01

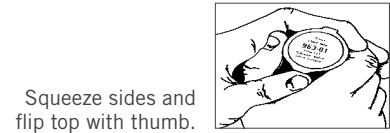

Item No	Description	Pkg	Min Qty	Case Qty	List Price
963-01	Silicone lubricant - ¼ oz. tub	B	24	240	1.99 EA

PTFE Packing Rope

- PTFE (Polytetrafluoroethylene)
- Replaces worn out packing

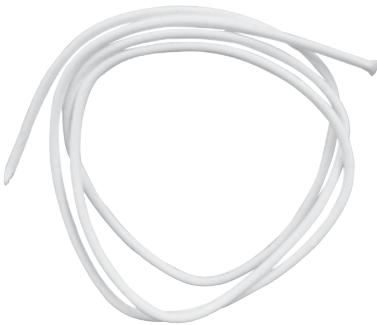

291-30400

Item No	Description	Pkg	Min Qty	Case Qty	List Price
291-30400	24" x 3/32" PTFE packing rope	B	24	240	1.85 EA

PTFE Pipe Thread Tape

- PTFE (Polytetrafluoroethylene)
- ½" and ¾" widths



335-260

Item No	Description	Pkg	Min Qty	Case Qty	List Price
335-260	½" x 260" (21.66 ft) spool	B	100	100	0.35 EA
335-520	½" x 520" (43.33 ft) spool	B	100	500	0.55 EA
335-263	¾" x 260" (21.66 ft) spool	B	70	350	0.54 EA
335-523	¾" x 520" (43.33 ft) spool	B	70	350	0.90 EA



Duct Tape

Industrial and HVAC Grades

- HVAC grade has more adhesive
- HVAC grade is tested in accordance with UL 723
Flame Spread Index 5, Smoke Development Index 5



330-260



332-260

Item No	Description	Pkg	Min Qty	Case Qty	List Price
330-260	2" wide x 60 yard roll, industrial grade 9 mil	B	24	24	8.27 EA
332-260	2" wide x 60 yard roll, HVAC grade 11.5 mil	B	24	24	22.25 EA

Cement Stop Leak

- Perfect for patching sewer outlet, water service and around drains
- Sets up in just five minutes
- Mixing cup included in each jar
- 5 lb. plastic jar



963-05

Item No	Description	Pkg	Min Qty	Case Qty	List Price
963-05	Cement stop leak, 5 lb. plastic jar	B	5	5	15.99 EA

Oakum

- Use to pack spigot type cast iron pipe, cracks around doors, windows, driveways, etc.
- Does not irritate skin



963-15PK2

Item No	Description	Pkg	Min Qty	Case Qty	List Price
963-15PK2	Brown oakum 1 lb/bag	B	20	20	15.25 EA



961-20



961-22



961-30



961-32



961-50

Work Gloves

- 961-20: 100% cotton, medium weight (9 oz.) with knit wrist
- 961-22: Seamless, 100% cotton knit with rubber gripper dots, fits either hand
- 961-30: Leather, seamless “gun cut” palm area, waterproof cuff, elastic wrist
- 961-32/961-34: All leather, elastic wrist, available in large or x-large
- 961-50: Seamless, 100% cotton knit, with non-slip palm and fingertips

Item No	Description	Pkg	Min Qty	Case Qty	List Price
961-20	Brown jersey gloves	B	24	24	2.50 PR
961-22	Knit gloves with gripping dots	B	24	24	2.97 PR
961-30	Leather palm gloves with cuff	B	6	6	9.50 PR
961-32	All leather gloves, large	B	1	12	9.85 PR
961-34	All leather gloves, extra large	B	1	12	9.85 PR
961-50	Knit gloves with non-slip palm	B	10	160	3.99 PR

Disposable Latex Glove

- Extra large disposable latex gloves
- Powder-free, fits right or left hand
- This product contains natural rubber latex that may cause allergic reactions in some individuals



390-50178

Item No	Description	MIL	Pkg	Min Qty	Case Qty	List Price
390-50178	Standard weight, XL, job pack, 5/bag	5	B	1	10	4.50 BG
390-50179	Standard weight, XL, 100/box	5	B	1	5	31.50 BX
390-50177	Heavy-duty, XL, 50/box	10	B	1	5	31.25 BX

Disposable Shoe Covers

- Covers dirty work boots – saves clean up time
- Blue-spun polypropylene, non-waterproof
- Fits over shoe sizes 5 – 15



390-50175

Item No	Description	Pkg	Min Qty	Case Qty	List Price
390-50175	Shoe covers - job pack, 1 pair/bag	B	1	20	1.64 PR
390-50176	Shoe covers - bulk, 50 pair/box	B	50	50	0.75 PR

Dust Masks

- Comfortable, contour shape
- Non irritating – fiberglass free
- Fluid resistant
- Not for protection against asbestos, silica, cotton dust, gasses, mists, vapors or spray paint operations



390-50180

Item No	Description	Pkg	Min Qty	Case Qty	List Price
390-50180	Dust mask - job pack, 2/bag	B	2	20	0.55 EA
390-50181	Dust mask - bulk, 10/bag	B	10	50	0.50 EA

Tie-Down Strap

- Super-strong 100% EPDM material with 2½" galvanized S hooks



319-15

Item No	Description	Length	Maximum Length	Pkg	Min Qty	Case Qty	List Price
319-15	EPDM tie-down strap	15"	22"	B	50	50	2.40 EA
319-20	EPDM tie-down strap	20"	30"	B	50	50	2.58 EA
319-31	EPDM tie-down strap	31"	45"	B	50	50	3.38 EA



968-04

Multi-Purpose Square Bucket

- Heavy-duty plastic, 4.25 gallon
- Great for carrying tools, fittings, etc.
- Tight-fitting lid is included

Item No	Description	Pkg	Min Qty	Case Qty	List Price
968-04	Bucket, 4.25 gallon	B	8	8	10.80 EA

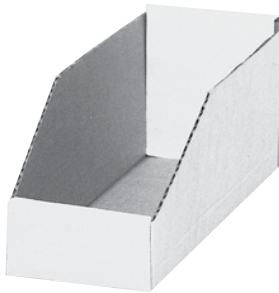

965-204

Corrugated Bin Box

- Perfect for warehouse, fab shop, on the truck, in the office or at home
- Fits standard 12" or 18" deep shelving

Item No	Description	Pkg	Min Qty	Case Qty	List Price
965-204	12" deep x 4" wide x 4½" high	B	25	25	1.80 EA
965-208	12" deep x 8" wide x 4½" high	B	25	25	2.35 EA
965-212	12" deep x 12" wide x 4½" high	B	25	25	3.00 EA
965-804	18" deep x 4" wide x 4½" high	B	25	25	2.50 EA
965-808	18" deep x 8" wide x 4½" high	B	25	25	3.00 EA
965-812	18" deep x 12" wide x 4½" high	B	25	25	3.25 EA

Peg Board Display Hook

- 8" long x 3/16" wire
- Works with 1/4" or 5/16" holes



390-50200

Item No	Description	Pkg	Min Qty	Case Qty	List Price
390-50200	Peg board hook	B	10	50	0.75 EA

APPENDIX

105 ALPHABETICAL INDEX

109 NUMERICAL INDEX

115 SAMPLES

117 REFERENCE DATA

121 SALES & REPS

125 WARRANTY





ALPHABETICAL INDEX

A - R 106

S - Z 107

A

Abrasive mesh 86
 Access box (see Ox Box)
 gas outlet box 67
 Acid brush 85
 Aerator adapter 42
 Aerator, faucet 42
 Air gap, dishwasher 43
 Allen wrench set 89
 Anti-siphon auto vent 45
 Anti-siphon ballcock 24
 Auto vent, anti-siphon 45

B

Ball valve, brass
 gas ball valve 65, 67
 Ballcock, anti-siphon 24
 Bar sink drain and strainer 53
 Basin wrench, telescopic 88
 Bibb washer, SBR 41
 Bin box, corrugated 100
 Box wrench, offset ratchet 88
 Box, corrugated bin 100
 Bucket, multi-purpose square 100
 Buna-N O-ring 42
 Bungee cord (see tie-down strap) 99

C

Cartridge puller, Moen 92
 Ceiling and floor plate 38
 Cement stop leak 97
 Closet bolt (see Plumb Perfect) 16–17
 Closet bolt cover (see Smart Cap) 18
 Closet bowl cushion 20
 Closet flange gasket, wax 20
 Combo washer, slip 52
 Compression Tools
 PowerPEX F2080 combo tool 75
 H2 hydraulic tool 75
 PowerPEX F2080 jaw set 74
 PowerPEX F2080 tool 74
 Condensate tailpiece, brass 55
 Copper cleaning pad 86
 Corrugated bin box 100
 Crimp ring removal tool 73
 Crimp tools
 PB F1380 72
 PowerPEX F1807 72–73
 PowerPEX V-Sleeve 73

D

Deburring tool 79
 DeSanko fitting 53
 Disconnect tool, Fit Quick 76
 Dishwasher air gap 43
 Dishwasher drain connector kit 44
 Dishwasher drain hose 44
 Dishwasher tailpiece 48, 54–55
 Disposal parts 45
 Disposal waste kit 48
 Drain connector kit for dishwasher 44
Drip-Free 52

Dry Seal Pipe Collar 31
 Duct tape 97
 Dust mask 99
 DWV connector, brass 53
 DWV slip joint adapter 53

E

Escutcheon 36–37
 Escutcheon, tub spout 32
 Expansion tools
 PowerPEX F2080 combo tool 75
 H2 hydraulic tool 75
 PowerPEX F2080 head 74
 PowerPEX F2080 tool 74
 Extension tube 50, 56

F

Faucet aerator 42
 Faucet handle puller 93
 Faucet hole cover 43
 Faucet seat wrench 90
 Faucet stem key 92
Fire Rated Ox Box 67
Fit Quick
 disconnect tool 76
 quarter-turn stop valve 38
 Fitting brushes 84
 Fittings
 Fit Quick 38, 76
 Flame protection pad 85
 Flange
 CTS 38
 log lighter 66
 Flappers 26
 Flaring tool 93
 Float ball, poly tank 28
 Float ball rod 28
 Floor and ceiling plate 38
 Flush valve balls 25
 Flush valve disc, American Standard 25
 Flush valve gasket, Mansfield 25
 Flush valve seal, American Standard 24
 Flush valve, plastic 24

G

Garbage disposal replacement parts 45
 Gas ball valve 65, 67
 Gas outlet boxes (see Ox Box) 67
 Gasket
 no putty 52
 spud 23
 tank-to-bowl 22
 wax 20
 Gauges, go/no-go 72–73
 Gloves
 disposable latex 98
 work 98
 Go/no-go gauge 72–73
 Grabber, flexible 94

H

Hacksaw 80
HearthMaster 63–66
 Hex key set (see Allen wrench) 89
 Hose clamp 44
 Hose washer 42

I

Industrial sink plug 53
 Inside pipe cutter 81
 Inspection mirror 94
 Internal adjustment cutter 78

K

Kitchen hose 43
 Knife, utility 79

L

Latex gloves, disposable 98
 Lavatory branch tailpiece 55
 Lavatory drain 53
 Levels 95
 Log lighter accessories 66
 Log lighter bar 64
 Log lighter kits 63
Long Branch 54

M

Major Tee 55
 Match holder 94
 Metal stud punch 82
 Mirror, inspection 94
 Moen cartridge puller 92

N

No-Putty Gasket 52

O

Oakum 97
 O-ring pick 93
 O-ring, Buna-N 42
 Outlet waste, center 49
 Outlet waste, end 49
Ox Box
 fire-rated gas box 67

P

P traps 48
 Packing rope, PTFE 96
 Peg board display hook 100
 Pipe collar 31
 Pipe dope/cement brush 85
 Pipe thread tape, PTFE 96
 Plastic tube cutter 78

Plate, floor and ceiling 38
 Pliers, slip joint 88
 Plug, industrial sink 53
Plumb Perfect 16
 Plumber's tape 96
 Plunger 95
 Poly sink tailpiece 50

R

Ratchet box wrench, offset 88
 Ratchet tube cutter 78

S

S traps 48
Safe-Flame 85
 Sand cloth 86
 Saw 80–81
Sawhorse 80
 SBR bibb washer 41
 Screwdriver, 6-in-1 92
 Shoe covers 99
 Shower arm and accessories 34
 Shower arm installation tool 34, 89
 Shower head 34
Shower WallNut 33
 Silicone lubricant 96
 Sink plug, industrial 53
 Sink tailpiece, brass 56
 Slip joint extension tube 56
 Slip joint pliers 88
 Slip nut 51
Smart Cap 18
Smart Spout 30
Snap One 37
Snap-It 17
 Socket wrench set 90
 Stainless steel supply connectors 40
 Strap, tie-down 99
 Strap wrench 89
 Stud punch, metal 82
 Supply step washer 41
 Supply stop
 compression 39
 Fit Quick 38
 PEX F1807 39
 sweat 39
 Supply tube 40
 Supply tube extension 41

T

Tailpiece and slip washer 51
 Tailpiece washer 51
 Tailpiece
 brass condensate 55
 brass sink 56
 dishwasher 48, 54–55
 lavatory branch 55
 poly sink 50
 Tank-to-bowl gaskets 22
 Tank ball and handle set 27
 Tank ball wire, brass 28
 Tank bolt set 23
 Tank bowl kits 21

Tank flappers 26
 Tank float ball, poly 28
 Tank handles 27
 Tape
 duct 97
 plumber's 96
 Tape measure 95
 Threaded tube, brass 56
 Tie-down strap 99
 Tool kit, PowerPEX F2080 75
 Tools 34, 72–100
 Touch-flush Eljer tank ball & handle set 27
 Trap
 P trap 48
 S trap 48
Trim Tite 36
 Tub faceplate 32
 Tub overflow gasket 32
 Tub spout 30–31
 Tub spout escutcheon 32
 Tube cutter
 copper 78
 internal adjustment 78
 mini 78
 plastic 78
 ratchet 78
 zip action 78
 Tube O.D. brush 86

U

Utility knife 79

V

Vacuum breaker, Sloan 23

W

WallNut 33
 Washer
 combo washer 52
 slip joint washer 52
 tailpiece washer 52
 Washer kits
 bibb 41
 O-ring 42
 Water heater element wrench 90
 Wax gasket 20
 Wedge, stability 19
Wedge-It 19
 Wet-proof cloth 86
 Wire cable saw 81
 Wobble Wedge (see Wedge It) 19
 Wrenches
 Allen/hex set 89
 faucet seat 90
 P.O. plug 90
 ratchet box 88
 shower arm installation tool 34, 89
 socket set 90
 strap 89
 telescopic basin 88
 water heater element 90

Z

Zip action cutter 78

NUMERICAL INDEX

Numerical Index

PLUMBING

GAS

TOOLS

APPENDIX

Item No.	Page No.	Min. Qty	Case Qty	List Price	UPC Bar-Coded	UPC 6-Digit 739236	Weight (lbs.)	Item No.	Page No.	Min. Qty	Case Qty	List Price	UPC Bar-Coded	UPC 6-Digit 739236	Weight (lbs.)
108-12	67	12	144	8.22		510167	0.3700	234-5B	48	25	25	3.08		501059	0.2560
108-12PK	67	12	12	10.61	✓	808028	0.3911	236-060	50	25	25	2.00		501066	0.1200
108-13	67	12	72	11.64		510174	0.5500	236-080	50	25	25	2.10		501073	0.1440
108-13PK	67	12	12	12.82	✓	808042	0.5773	236-120	50	25	25	2.40		501080	0.1920
108-14	67	6	60	23.94		808066	0.8780	236-160	50	25	25	3.80		501097	0.2786
109-31	39	10	150	7.94		519269	0.2624	236-160B	50	25	25	3.98		501103	0.3120
109-310	39	10	100	9.96		519276	0.3426	238-120	50	25	25	2.75		501110	0.2240
109-311	39	10	100	10.03		519283	0.3395	238-160	50	25	25	3.90		501127	0.3040
109-C21	39	10	150	8.57		519290	0.2822	239	45	50	50	3.92		518996	0.0761
109-F21	39	10	150	7.34		519306	0.2491	239PK2	45	10	10	4.66	✓	302007	0.1254
109-S21	39	10	150	6.92		519313	0.2242	242-10	43	1	10	11.52	✓	501141	0.5589
109-X21	39	10	150	7.06		519320	0.2192	242-20	43	1	100	2.00	✓	501158	0.0709
110-A31	39	10	150	9.10		500335	0.2844	242-20102	43	1	10	12.80	✓	501165	0.6129
110-CA21	39	10	150	9.35		556301	0.2998	242-20116	43	1	25	1.85	✓	501189	0.0787
110-FA21	39	10	150	10.10		556318	0.2818	242-25	43	1	10	5.73	✓	501196	0.1616
110-SA21	39	10	150	9.60		556332	0.2310	249	43	25	25	9.85		501202	0.2800
110-XA21	39	10	150	9.60		556349	0.2466	249-20135	43	1	10	5.15	✓	501219	0.3246
200-062	54	25	25	10.60		500472	0.3580	251-550	48	25	25	7.11		501226	0.4640
200-064	54	25	25	11.21		500489	0.4080	251-550B	48	25	25	7.30		501233	0.4920
200-066	54	25	25	14.25		500496	0.4080	253-550	49	25	25	5.95		501240	0.4240
200-082	54	25	25	11.19		500502	0.4301	253-550B	49	25	25	5.99		501257	0.4280
200-084	54	25	25	13.19		500519	0.4801	253-552	49	15	15	7.43		501264	0.4530
200-122	54	25	25	14.77		500540	0.5573	253-552B	49	15	15	7.46		501271	0.4530
200-124	54	25	25	15.38		518965	0.6073	253-553	49	15	15	7.47		501288	0.4797
200-124PK	54	25	25	15.59	✓	500557	0.6276	257-550	49	25	25	6.94		501295	0.5840
204-068	54	25	25	16.00		500380	0.4069	257-550B	49	25	25	6.87		501301	0.5440
206-064	54	25	25	13.23		500397	0.4740	258-160	49	25	25	7.43		501318	0.6240
206-066	54	25	25	16.89		500588	0.4640	270-6	53	25	25	7.48		501325	0.3735
206-084	54	25	25	14.26		500595	0.6946	272-6	53	25	25	7.88		501349	0.5219
210-064	55	25	25	11.74		500601	0.3841	274-5	53	10	100	6.20		501356	0.0635
210-066	55	25	25	15.52		500618	0.3841	274-6	53	10	100	6.42		501363	0.0698
210-084	55	25	25	13.11		500625	0.4563	274-7	53	10	100	6.52		501370	0.0620
210-086	55	25	25	16.53		500632	0.4563	280-12	40	100	100	4.73		501394	0.1260
210-122	55	25	25	15.20		500649	0.5334	280-20	40	100	100	8.35		501400	0.2020
213-060	55	25	25	11.24		504838	0.3166	280-36	40	50	50	11.85		501417	0.3680
213-061	55	25	25	12.79		509550	0.3240	280-100	40	100	2000	0.50		501387	0.0038
213-067	55	25	25	14.61		500670	0.3378	281-072	40	1	12	8.48		556615	0.4745
213-068	55	25	25	14.87		509574	0.3166	281-12	40	100	100	4.29		566744	0.1602
213-069	55	25	25	11.12		509567	0.2911	281-16	40	100	100	4.78		566751	0.1852
215-064	55	25	25	12.47		500700	0.3503	281-20	40	100	100	4.61		566768	0.2185
215-066	55	25	25	16.14		500717	0.3503	281-30	40	100	100	6.65		566775	0.2646
216-084	55	25	25	14.23		500724	0.4306	283-12	40	50	50	6.40		501424	0.1320
216-086	55	25	25	17.85		500731	0.4480	283-20	40	50	50	9.45		501431	0.2300
220-040	56	50	50	4.06		500748	0.1461	284-09	40	100	100	3.14		566782	0.1340
220-048	56	48	48	5.66		500755	0.1290	284-12	40	100	100	3.38		556790	0.1539
220-068	56	24	24	6.31		500762	0.1900	284-20	40	100	100	4.30		519337	0.2231
220-088	56	24	24	7.73		500779	0.2480	285-100	40	100	10000	0.10		501448	0.0011
220-120	56	25	25	8.97		500786	0.4209	285-12	40	100	100	0.96		501455	0.0350
220-128	56	24	24	10.96		500793	0.3920	285-20	40	100	100	1.25		501462	0.0532
220-168	56	24	24	15.15		500809	0.4960	285-30	40	100	100	1.75		501479	0.0880
223-128	56	24	24	14.19		500403	0.4400	285-36	40	100	100	1.99		501486	0.0946
224-128	56	24	24	16.78		500410	0.5280	287-12	40	100	100	1.00		501493	0.0351
225-068	56	24	24	10.74		500427	0.2045	287-20	40	100	100	1.39		501509	0.0600
225-088	56	24	24	11.56		500434	0.2880	289-12	41	100	100	2.34		501516	0.1110
225-128	56	24	24	14.77		500854	0.3496	289-20	41	100	100	3.70		501523	0.1863
226-068	56	24	24	11.19		500861	0.2720	290-20180	45	5	25	0.75	✓	501530	0.0350
226-088	56	24	24	12.77		500878	0.3440	290-20185	45	1	12	3.32	✓	501554	0.1813
226-128	56	24	24	16.36		500885	0.4640	290-20200	53	1	10	23.90	✓	501561	0.8028
230-040	50	25	25	0.95		500892	0.0548	290-20300	52	25	300	0.48		501585	0.0069
230-040B	50	25	25	0.90		500908	0.5208	290-20301	52	100	1000	0.44		501592	0.0068
230-060	50	25	25	0.90		500359	0.0880	290-20310	52	25	300	0.48		509581	0.0069
230-080	50	25	25	1.15		500458	0.1120	290-20311	52	100	1000	0.44		501615	0.0061
230-120	50	25	25	1.80		500465	0.1440	290-20313	52	50	500	0.55		501639	0.0103
230-160	50	25	25	3.10		500946	0.1924	290-20320	52	100	1000	1.05		501646	0.0053
230-160B	50	25	25	3.10		500953	0.1900	290-20320PK2	52	1	12	4.20	✓	566157	0.0531
231-2	48	25	25	2.60		500960	0.1520	290-20322	52	100	1000	0.82		501653	0.0020
231-3	48	25	25	2.61		500977	0.1520	290-20322PK2	52	1	12	3.52	✓	566164	0.0334
232-2	48	25	25	2.88		500984	0.1504	290-20324	52	100	1000	0.82		501660	0.0040
232-3	48	25	25	2.88		500991	0.1680	290-20324PK2	52	1	12	3.52	✓	566171	0.0414
232-3B	48	25	25	2.89		501004	0.1680	290-20380	52	25	300	0.48		501684	0.0069
234-10	48	25	25	2.07		501011	0.3760	290-20381	52	100	1000	0.44		501691	0.0068
234-10B	48	25	25	2.07		501028	0.3440	290-20400	39	1	20	8.75	✓	501707	0.2647
234-2	48	25	25	7.02		501035	0.8802	290-20480	41	50	500	0.50		501714	0.0165
234-5	48	25	25	3.08		501042	0.2640	290-20482	41	50	500	0.50		501721	0.0245

Item No.	Page No.	Min. Qty	Case Qty	List Price	UPC Bar-Coded	UPC 6-Digit 739236	Weight (lbs.)	Item No.	Page No.	Min. Qty	Case Qty	List Price	UPC Bar-Coded	UPC 6-Digit 739236	Weight (lbs.)
290-20514	53	1	12	21.75	✓	501745	0.8759	306-10	88	10	50	21.50	✓	504340	0.9490
290-21100	42	6	48	2.75		501974	0.0542	307-616	33	1	10	16.25	✓	400321	0.3955
290-21104	42	6	48	2.93		501998	0.0435	307-625	89	1	6	7.55	✓	400130	0.9597
290-21110	42	5	250	4.75		502018	0.0844	308-2	93	1	12	39.00	✓	556257	2.5488
291-30125	41	1	10	22.18	✓	502230	0.8006	310-05	95	1	12	11.00	✓	290007	0.7973
291-30126	41	1	10	40.30	✓	502247	0.8800	310-10	95	1	24	3.00	✓	556325	0.1206
291-30225	41	1	10	29.00	✓	502377	1.0209	310-12	95	1	10	14.60	✓	566126	0.4762
291-30226	41	1	10	35.25	✓	502384	1.3316	311-10	90	1	5	15.25	✓	504388	2.1313
291-30380	42	1	10	29.50	✓	502650	0.5450	312-2	95	1	12	7.65		504395	1.4057
291-30400	96	24	240	1.85		502667	0.0281	313-20	89	1	12	18.00	✓	566379	0.5983
291-30500	42	12	240	0.25		502834	0.0052	314-10	92	12	12	8.50		504418	0.3363
300-12	80	12	12	16.10		500120	0.4982	314-12	92	12	12	9.00	✓	566324	1.9400
300-12B	80	1	25	12.98		500137	0.3401	314-20	92	1	25	4.50		566096	0.1040
300-20	80	4	4	37.14		500205	1.0800	315-1	79	10	100	1.45	✓	504432	0.0150
300-20B	80	6	6	25.53		504173	1.1031	315-10	79	12	60	8.00		504449	0.4566
301-061	80	5	100	0.72		500373	0.0396	316-1	88	1	12	5.45		566409	0.2168
301-062	80	10	10	12.97		500267	0.3760	316-2	88	1	12	7.61		566416	0.3469
301-065	80	20	20	2.71		500366	0.1700	318-4	93	1	5	15.64	✓	566430	0.6511
304-06	79	1	24	7.65	✓	520432	0.1364	318-9	89	1	10	6.50	✓	566447	0.3638
304-08	78	12	72	16.70	✓	510150	0.2760	319-15	99	50	50	2.40		504463	0.3000
304-1	78	1	50	5.50		500571	0.0726	319-20	99	50	50	2.58		504470	0.3400
304-11	78	1	12	20.72	✓	567161	0.6750	319-31	99	50	50	3.38		504487	0.3168
304-12	78	1	12	16.70	✓	566119	0.3379	330-260	97	24	24	8.27		504494	1.5500
304-12B	78	1	12	6.75		566102	2.4279	332-260	97	24	24	22.25		504500	2.0563
304-20	78	1	24	7.50	✓	566461	0.2411	335-260	96	100	100	0.35		504517	0.0240
304-25	78	1	10	21.90	✓	566201	0.5630	335-263	96	70	350	0.54		504524	0.0384
304-30	78	1	10	35.20	✓	556219	0.8366	335-520	96	100	500	0.55		509253	0.0280
304-32	78	1	20	3.95	✓	556226	0.0988	335-523	96	70	350	0.90		504548	0.0428
304-6B	79	1	50	10.00	✓	556233	0.0377	390-50105	81	1	25	3.10	✓	500243	0.0517
305-100PK1	72	1	10	45.13	✓	520425	1.1796	390-50110	94	1	25	7.65	✓	504609	0.0848
305-20CPK	72	1	10	170.00	✓	500823	2.6786	390-50115	94	1	24	9.75	✓	504616	0.1860
305-23CPK	72	1	10	170.00	✓	566829	3.2000	390-50117	94	1	25	3.00	✓	504623	0.2227
305-30CPK	72	1	10	170.00	✓	500830	3.0665	390-50128	92	1	12	10.25	✓	504678	0.3167
305-40CPK	72	1	10	180.00	✓	566836	3.6000	390-50130	90	1	25	25.50	✓	504685	1.1512
305-41CKIT	72	1	10	252.88	✓	505132	6.1855	390-50132	90	1	12	6.20	✓	504692	0.2742
305-521PK	82	1	1	280.00	✓	566737	8.9000	390-50133	90	1	12	8.40	✓	504708	0.4203
305-521PKB	82	1	10	16.25	✓	566812	0.3900	390-50134	92	1	12	4.75	✓	507341	0.3890
305-82TX	73	1	10	220.00	✓	500175	4.6495	390-50138	93	1	12	4.60	✓	504739	0.0725
305-83TX	73	1	10	220.00	✓	501134	4.6495	390-50148	95	1	12	18.25	✓	504777	1.6950
305-84TX	73	1	10	270.00	✓	501677	5.3950	390-50153	81	1	100	9.00	✓	500687	0.1733
305-85TX	73	1	12	9.15	✓	501738	0.1808	390-50154	81	1	100	7.80	✓	500694	0.0512
305-91PK	72	1	12	130.00	✓	566669	3.2187	390-50155	81	1	5	24.50		202338	1.1468
305-92PK	72	1	10	130.00	✓	566676	3.4107	390-50160	85	1	25	16.90	✓	501608	0.4343
305-92TX	73	1	10	185.00	✓	501905	2.6300	390-50163	81	1	10	14.10	✓	500656	0.2977
305-93PK	72	1	10	130.00	✓	566683	3.5908	390-50164	81	1	100	3.20	✓	500663	0.0327
305-95	72	12	12	6.96	✓	504333	0.0813	390-50175	99	1	20	1.64		504883	0.0822
305-99	73	1	10	58.00	✓	566454	0.8168	390-50176	99	50	50	0.75		504890	0.0567
305-A137964	74	1	1	1237.00		500168	5.2500	390-50177	98	1	5	31.25		504906	2.3310
305-A139092	78	1	10	235.00		566874	2.5287	390-50178	98	1	10	4.50		504913	0.1900
305-A139092B	78	1	25	27.85		566089	0.3930	390-50179	98	1	5	31.50		504920	2.0000
305-A139592-0	74	1	1	300.94		566881	1.6512	390-50180	99	2	20	0.55		504937	0.0325
305-A235407	75	1	1	8,008.13		566898	75.0000	390-50181	99	10	50	0.50		504944	0.0181
305-A235417-5	74	1	1	191.58		566997	0.4645	390-50185	90	1	10	9.50	✓	504951	0.4570
305-A235427-6	74	1	1	290.11		567000	0.0000	390-50197	88	1	20	18.75	✓	504999	1.8151
305-A235437-7	74	1	1	317.34		567017	2.1500	390-50198	90	1	20	7.15	✓	505002	0.5243
305-A235497	74	1	1	1,317.79		566904	5.8100	390-50200	100	10	50	0.75		505026	0.1101
305-A243107	75	1	1	423.41		566911	2.9375	402-10	20	24	24	2.25		566638	0.4877
305-A243737	74	1	1	572.92		566955	3.4167	402-410	20	24	24	3.88	✓	519344	0.6074
305-A243767	74	1	1	123.79		566928	0.9000	402-427	20	24	24	3.75	✓	519405	0.5381
305-A243787	74	1	1	109.94		566935	1.3500	402-440	20	24	24	5.50	✓	508935	0.6621
305-A243797	74	1	1	112.08		566942	1.2120	410	17	100	1000	0.80		505040	0.0470
305-A261216	75	1	1	1,990.40		566843	15.6700	410-PB	17	50	50	1.50		519009	0.0960
305-A261246	75	1	1	1,374.81		566966	12.6000	411	17	100	500	1.07		505064	0.0575
305-A261256	75	1	1	2,232.65		566973	18.3000	411-PB	17	50	50	2.13		519061	0.1179
305-A261856-1	74	1	1	196.11		567024	0.3395	412-PB	17	50	50	1.92	✓	519016	0.0987
305-A261866-2	74	1	1	168.98		567031	0.3593	412-PBPK2	17	25	25	2.02	✓	304162	0.1022
305-A261886-3	74	1	1	171.93		567048	7.6850	414-PB	17	50	50	2.75	✓	519023	0.1445
305-A261896-4	74	1	1	176.84		567055	0.4079	415	17	100	500	1.06		505101	0.0694
305Q2	76	1	24	1.74	✓	400468	0.0179	415-PB	17	50	50	2.00		505118	0.1425
305Q3	76	1	24	1.74	✓	400482	0.0292	416	17	100	500	1.19		505125	0.0604
305Q4	76	1	12	1.95	✓	400499	0.0421	416-PB	17	50	50	2.48		519030	0.1245
305Q5	76	1	1	19.25		408006	0.3450	416PK2	17	25	25	2.48	✓	304063	0.1280
305Q6	76	1	10	20.50		408013	0.3650	417	17	100	1000	0.13		505149	0.0095
305Q7	76	1	1	20.50		407979	0.4380	418	17	100	1000	0.22		505156	0.0125

PLUMBING

GAS

TOOLS

APPENDIX

A 10% surcharge will be applied to any item NOT purchased in multiples of the stated Minimum Quantity, except on drop ship orders. Items that are bold in the Min Qty column may NEVER be broken

Numerical Index

CATALOG 2013

PLUMBING

GAS

TOOLS

APPENDIX

Item No.	Page No.	Min. Qty	Case Qty	List Price	UPC Bar-Coded	UPC 6-Digit 739236	Weight (lbs.)	Item No.	Page No.	Min. Qty	Case Qty	List Price	UPC Bar-Coded	UPC 6-Digit 739236	Weight (lbs.)
419	17	100	5000	0.15		505163	0.0061	490-11150	24	1	12	7.66	✓	506405	0.6612
425	16	100	100	0.46		304100	0.0199	490-11151	24	1	12	7.90	✓	506412	0.3766
425-N	16	100	500	0.35		501912	0.0071	490-11152	24	5	25	1.88		506429	0.0889
425-PB	16	25	250	0.98		505262	0.0420	490-11155	27	1	12	12.02	✓	506436	0.2838
425-PBJ	16	1	1	50.50		520364	2.6668	490-11157	27	1	12	6.05	✓	506450	0.1481
425-PBPK2	16	10	10	1.22	✓	304124	0.0567	490-11159	27	1	12	8.10	✓	506474	0.3451
427	16	100	100	0.54		505316	0.0238	490-11221	17	25	2500	0.41		506535	0.0083
427-PB	16	50	50	1.12		510136	0.0505	490-11223	17	25	2500	0.65		506542	0.0153
427-PBJ	16	1	1	62.00	✓	510136	3.1075	490-11227	17	25	2500	0.50		506559	0.0133
427-PBPK2	16	10	10	1.38	✓	304346	0.0647	490-11240	18	1	50	1.25	✓	506566	0.0378
440-2W	18	1	25	2.75	✓	556608	0.0094	490-11520	23	5	25	0.98		506610	0.0779
442-2B	18	1	25	1.80	✓	506467	0.0094	490-11522	23	5	25	1.00		506627	0.0609
442-2W	18	1	25	1.80	✓	566584	0.0621	490-11530	23	5	25	1.25		506634	0.0589
452-PB	23	50	50	5.25		304247	0.2289	616-02C	33	25	25	4.75	✓	506894	0.1147
460-10	19	100	1000	0.26		505354	0.0118	616-02P	33	25	25	4.75	✓	506917	0.1806
460-10J	19	1	1	58.00	✓	519047	2.1200	616-02RB	33	1	25	18.00	✓	403551	0.1113
460-11300	19	1	10	3.12		315106	0.1350	616-02SN	33	1	25	16.75	✓	506931	0.1113
460-11310	19	1	10	3.95		315120	0.1349	616-02W	33	25	25	4.35	✓	506948	0.1776
460-20	19	100	1000	0.35		505408	0.0118	648X2FA	39	5	60	9.13		485328	0.1757
460-20J	19	1	1	74.00	✓	519054	2.8350	648X2FS	39	5	60	10.37		506979	0.2273
490-10108	26	1	25	4.11	✓	505484	0.1126	700-0	84	12	120	1.83		507044	0.0750
490-10110	26	1	25	4.04	✓	505507	0.1224	700-1	84	12	120	1.83		507051	0.0800
490-10112	26	1	25	7.28	✓	505521	0.6314	700-2	84	12	120	1.83		507068	0.0815
490-10115	26	1	25	5.46	✓	505538	0.1468	700-3	84	12	120	1.90		403735	0.0960
490-10120	26	1	25	5.42	✓	505552	0.1036	700-4	84	12	120	2.08		403742	0.0927
490-10121	26	1	25	6.27	✓	505569	0.1264	700-5	84	6	60	2.26		507099	0.1110
490-10122	26	1	25	1.21	✓	505576	0.0205	700-6	84	6	60	2.47		507105	0.1098
490-10125	26	1	20	4.31	✓	505583	0.1015	700-7	84	6	60	2.87		507112	0.1167
490-10206	25	1	25	4.21	✓	505637	0.1672	702-2	84	24	240	1.10		507150	0.0530
490-10211	25	1	50	2.08	✓	505651	0.1298	702-3	84	24	240	1.14		507167	0.0550
490-10302	25	1	25	4.16	✓	505668	0.0904	702-4	84	24	240	1.30		507174	0.0640
490-10306	25	25	25	1.74		505699	0.1172	703-2	84	24	240	1.26		507181	0.0540
490-10312	25	1	25	4.18	✓	505705	0.0904	703-3	84	24	240	1.29		507198	0.0560
490-10316	25	25	25	2.10		505736	0.1064	703-4	84	24	240	1.07		507204	0.0630
490-10320	24	1	50	1.63	✓	505743	0.0382	703-5	84	12	120	2.26		507211	0.0793
490-10325	27	1	12	10.31	✓	505750	0.3030	703-6	84	6	60	2.47		507228	0.1033
490-10340	25	1	25	4.26	✓	505781	0.0951	703-7	84	6	60	2.79		507235	0.1090
490-10341	25	1	25	2.22	✓	505798	0.0238	704-2	84	12	72	1.91		507242	0.0960
490-10411	28	25	100	1.03		505910	0.0359	704-3	84	12	72	1.99		507259	0.0960
490-10415	28	25	200	0.88		505934	0.0201	704-4	84	12	72	2.22		507266	0.0980
490-10451	28	24	24	1.19		505965	0.2623	705-2	84	12	120	4.80		507273	0.1100
490-10465	24	1	12	14.50		505989	1.2447	705-3	84	12	120	4.98		507280	0.1270
490-10466	24	1	12	2.98		505996	0.0925	705-4	84	12	120	5.05		507297	0.1220
490-10467	24	1	12	4.15		506009	0.1214	706-2	84	6	60	1.10		507303	0.0420
490-10500	23	1	50	7.74	✓	506016	0.2806	706-3	84	6	60	1.15		507310	0.0726
490-10502	23	25	250	0.32		506023	0.0273	706-4	84	6	60	1.30		507327	0.0770
490-10505	23	25	200	1.11		506580	0.0117	707-2	84	6	60	1.20		507334	0.0681
490-10540	20	10	10	4.08		506047	0.3037	707-3	84	6	60	1.25		509505	0.0712
490-10541	20	10	10	3.44		506054	0.1857	707-4	84	6	60	1.37		507358	0.0738
490-10542	20	10	10	3.72		506061	0.2347	710-2	86	6	120	4.10		404022	0.0580
490-10543	20	10	10	4.36		506078	0.4110	710-3	86	6	120	4.60		404039	0.0573
490-10545	20	10	10	3.70		506092	0.3215	710-4	86	6	120	5.21		507389	0.0674
490-10546	20	10	10	4.59		304469	0.4445	730-05	86	1	24	5.27	✓	405968	0.3080
490-10547	20	10	10	5.11		506115	0.4730	730-10	86	1	24	8.82	✓	403025	0.5680
490-10548	20	10	10	6.85		506122	0.7435	730-25	86	1	12	19.65	✓	405975	1.1000
490-10555	21	1	25	7.75	✓	506139	0.3507	740-02	86	1	50	1.64	✓	406019	0.0840
490-10560	21	1	25	7.75	✓	506146	0.3544	740-05	86	1	24	2.89	✓	405982	0.2360
490-10565	21	1	25	7.75	✓	506153	0.4241	740-10	86	1	24	5.41	✓	403056	0.4260
490-10570	21	1	25	10.25	✓	506160	0.5304	740-25	86	1	12	12.05	✓	405951	1.1971
490-10572	21	1	25	10.85	✓	506177	0.5624	743-05	86	1	24	4.20	✓	405999	0.3640
490-10575	21	1	25	7.75	✓	506184	0.3517	743-10	86	1	24	7.49	✓	403353	0.5680
490-10585	21	1	25	10.50	✓	506191	0.5460	743-25	86	1	12	17.79	✓	406002	1.0817
490-10656	22	25	25	1.21		506214	0.0719	750-46	86	1	14	7.72		507495	0.3029
490-10661	22	25	25	1.54		506238	0.1114	750-69	86	1	12	6.55		507501	0.3580
490-10666	22	25	25	1.78		506252	0.1402	752-69	86	1	12	4.97		507518	0.3797
490-10671	22	25	25	1.58		506276	0.1406	771	85	1	12	21.25		507525	2.1940
490-10673	22	25	25	1.31		506290	0.1479	772	85	1	12	26.85		507532	2.4330
490-10676	22	25	25	1.75		506313	0.0729	773	85	36	360	1.30		507549	0.0360
490-10700	23	1	12	2.44	✓	506320	0.0650	774	85	36	36	2.02		507556	0.0353
490-11100	27	1	25	4.17	✓	506337	0.2702	776	85	24	24	2.97		507563	0.0710
490-11101	27	50	50	3.29		506344	0.2180	777	85	24	24	3.32		507570	0.0790
490-11120	27	1	15	8.25	✓	506351	0.2833	901	44	100	100	0.93		507617	0.0569
490-11130	27	1	12	2.95	✓	506368	0.1018	901-10	44	10	100	0.97		507624	0.0585
490-11140	27	1	12	6.36	✓	506375	0.1681	901-12	44	10	100	1.07		507631	0.0595

Item No.	Page No.	Min. Qty	Case Qty	List Price	UPC Bar-Coded	UPC 6-Digit 739236	Weight (lbs.)	Item No.	Page No.	Min. Qty	Case Qty	List Price	UPC Bar-Coded	UPC 6-Digit 739236	Weight (lbs.)
901-16	44	10	100	1.10		507648	0.0630	927-3W	37	12	120	0.77		508096	0.0228
901-20	44	10	100	1.11		507655	0.0635	927-4	37	12	120	1.30		430236	0.0279
901-24	44	10	100	1.20		507662	0.0664	927-4PK2	37	12	12	1.51	✓	430229	0.0444
901-28	44	10	100	1.23		507679	0.0709	927-4W	37	12	120	0.87		508119	0.0230
901-32	44	10	100	1.27		507686	0.0566	927-5PK2	37	12	12	2.19	✓	430427	0.0611
902	44	50	50	3.15		507693	0.1972	927-6	37	12	120	1.83		430274	0.0380
905	44	1	1	62.00	✓	507709	10.8000	927-6PK2	37	12	12	2.28	✓	430267	0.0541
905-PK	44	1	1	1.24		500564	10.8000	927-6W	37	12	120	1.05		508133	0.0330
906	44	1	1	86.50	✓	507716	18.6000	927-7	37	12	120	2.03		430298	0.0446
906-PK	44	1	1	1.73		200266	18.6000	927-7PK2	37	12	12	2.55	✓	430281	0.0613
910-2	37	25	250	0.32		408068	0.0286	927-7W	37	12	120	1.04		508157	0.0410
910-2PK2	37	10	10	1.06	✓	408044	0.0795	927-8W	37	12	120	1.97		508164	0.0452
910-3	37	25	250	0.34		408143	0.0230	928-12	31	50	500	0.23		508171	0.0067
910-3PK2	37	10	10	1.10	✓	408129	0.0815	928-125	31	50	500	0.23		508188	0.0055
911-2	37	25	250	0.36		408105	0.0286	928-13	31	50	500	0.23		508195	0.0064
911-2PK2	37	10	10	1.10	✓	408082	0.0795	928-2	31	50	500	0.23		508201	0.0063
911-3	37	25	250	0.40		408181	0.0226	928-3	31	50	500	0.23		508218	0.0116
911-3PK2	37	10	10	1.15	✓	408167	0.0676	940-10	64	6	6	13.22		508232	2.4522
911-4	37	25	250	0.46		408235	0.0284	940-10PK1	64	1	10	14.78	✓	600127	2.5268
911-4PK2	37	10	10	1.25	✓	408228	0.0791	940-11	64	6	6	13.22		508249	2.5422
911-6	37	25	250	0.55		408273	0.0297	940-12	64	6	6	13.12		508256	2.4922
911-6D	37	25	250	0.76		507785	0.0469	940-13	64	6	6	13.12		508263	2.6082
911-6PK2	37	10	10	0.83	✓	408266	0.0520	948	66	12	12	4.49		508270	0.2279
911-7	37	25	250	0.91		408297	0.0459	948-EX	66	12	120	2.02		508287	0.0514
911-7PK2	37	10	10	1.16	✓	408280	0.0700	948-P	66	1	12	5.09		508294	0.2382
916-2	38	12	120	1.10		409065	0.0467	948PK2	66	10	10	5.56	✓	603203	0.2514
916-2PK2	38	12	12	1.45	✓	409041	0.0524	948-PPK2	66	1	10	6.46	✓	603265	0.2514
916-3	38	12	120	1.12		409140	0.0448	949	66	12	120	1.58		508317	0.1427
916-3PK2	38	12	12	1.49	✓	409126	0.0552	949-1PK2	66	1	10	1.61	✓	604705	0.1641
916-4	38	12	120	1.18		409218	0.0459	949-06	66	1	10	4.19		508324	0.2471
916-4PK2	38	12	12	1.51	✓	409201	0.0652	949-10	66	1	50	4.80		605108	0.3324
917-2	38	12	120	1.01		409102	0.0429	949-12	66	1	50	5.25		508355	0.3329
917-2PK2	38	12	12	1.29	✓	409089	0.0622	949-12PK2	66	1	10	5.56	✓	605122	0.3523
917-3	38	12	120	1.10		409188	0.0509	949-21	66	1	50	7.24		605214	0.6310
917-3PK2	38	12	12	1.41	✓	409164	0.0702	949-CP	66	12	120	2.47	✓	508386	0.1427
917-4	38	12	120	1.20		409232	0.0609	949-F	66	1	25	3.52		603500	0.1526
917-4PK2	38	12	12	1.49	✓	409225	0.0587	949-K09	66	1	1	3.94		508409	0.2281
917-6	38	12	120	1.28		409270	0.0596	949-K09P	66	1	1	6.36		508416	0.2481
917-6PK2	38	12	12	1.58	✓	409263	0.0887	949-K09PK2	66	1	10	5.10	✓	604293	0.2563
920-1W	36	50	500	0.16		407030	0.0151	949-K12	66	1	1	6.10		508423	0.2684
920-2W	36	25	250	0.18		407061	0.0156	949-K12PK2	66	1	10	7.96	✓	604323	0.2963
920-2WPK2	36	10	10	0.65	✓	407047	0.0463	949-P	66	1	12	2.66		508430	0.1426
920-3W	36	25	250	0.20		407146	0.0154	949PK2	66	1	10	2.15	✓	604200	0.1641
920-3WPK2	36	10	10	0.68	✓	407122	0.0459	949-PPK2	66	1	10	3.22	✓	604262	0.1641
920-4W	36	20	100	0.45		407214	0.0429	952	65	1	24	21.66		508447	0.9731
920-4WPK2	36	10	10	1.20	✓	407207	0.1014	952-P	65	1	6	24.22		508454	0.9884
921-2W	36	50	500	0.20		407108	0.0149	952-PK1	65	1	6	23.37	✓	612809	1.1484
921-2WPK2	36	10	10	0.69	✓	407085	0.0483	952-PPK1	65	1	6	25.82	✓	612861	1.1484
921-3W	36	50	500	0.22		407184	0.0152	952-V	65	1	12	13.36		622822	0.6032
921-3WPK2	36	10	10	0.74	✓	407160	0.0488	953	63	1	6	32.01	✓	508478	3.7755
921-4W	36	20	100	0.41		407238	0.0429	953-12	63	1	6	31.44	✓	508485	3.8158
921-4WPK2	36	10	10	1.22	✓	407221	0.1293	954	65	1	24	20.75		508515	0.9400
921-6W	36	20	100	0.39		407276	0.0379	954-P	65	1	6	23.85		508522	0.9553
921-6WPK2	36	10	10	0.63	✓	407269	0.0541	954-PK1	65	1	6	24.11	✓	612304	1.1152
921-7W	36	20	100	0.41		407290	0.0349	954-PPK1	65	1	6	25.22	✓	612366	0.9985
921-7WPK2	36	10	10	0.65	✓	407283	0.0511	954-V	65	1	12	12.87		622327	0.5701
922-5W	36	25	25	0.65		507983	0.1038	955	63	1	6	32.01	✓	508546	3.7423
922-5WPK2	36	10	10	0.93	✓	407320	0.1091	955-12	63	1	6	31.44	✓	508553	3.7827
922-6W	36	25	25	0.65		507990	0.1028	961-20	98	24	24	2.50		508584	0.1617
922-6WPK2	36	10	10	0.93	✓	407344	0.1081	961-20150	43	1	25	2.09	✓	508591	0.1373
926-2	37	12	120	1.09		430069	0.0157	961-20155	43	1	25	3.05	✓	508607	0.0485
926-2PK2	37	12	12	1.35	✓	430045	0.0283	961-20158	43	1	25	2.96	✓	508614	0.0300
926-2W	37	12	120	0.73		508010	0.0145	961-22	98	24	24	2.97		508645	0.1960
926-3	37	12	120	1.12		430144	0.0210	961-30	98	6	6	9.50		508652	0.6736
926-3PK2	37	12	12	1.40	✓	430120	0.0444	961-32	98	1	12	9.85		508669	0.2745
926-3W	37	12	120	0.77		508034	0.0165	961-34	98	1	12	9.85		508676	0.6495
926-4	37	12	120	1.23		430212	0.0250	961-50	98	10	160	3.99		508683	0.2813
926-4PK2	37	12	12	1.51	✓	430205	0.0444	961-6	43	25	25	1.35		508690	0.0887
926-4W	37	12	120	0.88		508058	0.0220	961-7	43	25	25	1.73		508706	0.1287
927-2	37	12	120	1.09		495426	0.0190	963-01	96	24	240	1.99		508751	0.0310
927-2PK2	37	12	12	1.40	✓	430083	0.0444	963-05	97	5	5	15.99		508768	5.2760
927-2W	37	12	120	0.76		508072	0.0250	963-15PK2	97	20	20	15.25		517012	1.0020
927-3	37	12	120	1.21		430182	0.0250	965-204	100	25	25	1.80		508836	0.2000
927-3PK2	37	12	12	1.60	✓	430168	0.0444	965-208	100	25	25	2.35		508843	0.3140

PLUMBING

GAS

TOOLS

APPENDIX

A 10% surcharge will be applied to any item NOT purchased in multiples of the stated Minimum Quantity, except on drop ship orders. Items that are bold in the Min Qty column may NEVER be broken

Numerical Index

CATALOG 2013

PLUMBING

GAS

TOOLS

APPENDIX

Item No.	Page No.	Min. Qty	Case Qty	List Price	UPC Bar-Coded	UPC 6-Digit 739236	Weight (lbs.)
965-212	100	25	25	3.00		508850	0.3800
965-804	100	25	25	2.50		508867	0.2520
965-808	100	25	25	3.00		508874	0.4160
965-812	100	25	25	3.25		508881	0.4240
968-04	100	8	8	10.80		508898	1.9270
972-10	31	1	50	8.61	✓	508942	0.5353
972-100	32	1	12	9.97	✓	508959	0.1319
972-15	31	1	50	15.37	✓	508973	0.6496
972-20	31	1	50	8.46	✓	508997	0.7796
972-30	31	1	50	15.24	✓	509000	0.6816
972-32	30	1	18	16.15	✓	566140	0.8378
972-32RB	30	1	18	18.25	✓	509239	0.8408
972-32SN	30	1	18	18.25	✓	509055	0.8396
972-35	31	1	50	19.48	✓	509024	0.7194
972-36	30	1	18	21.10	✓	556806	0.9376
972-361PK2	30	6	6	27.67	✓	501868	1.1533
972-362PK2	30	6	6	30.25	✓	501875	1.1617
972-36RB	30	1	18	24.25	✓	509109	0.9161
972-36SN	30	1	18	24.25	✓	509123	0.8114
972-3RA	30	1	10	11.25	✓	501837	0.3013
972-3RAKIT	30	1	10	6.90	✓	501882	0.1010
974-60100	32	1	20	5.69	✓	509048	0.2689
974-60102	32	1	12	4.01	✓	509062	0.1920
974-60105	32	6	120	1.80		509079	0.0397
974-60116	32	12	120	1.00		509093	0.0549
974-60300	34	1	6	23.00	✓	509130	0.5823
974-60304	34	1	25	5.81	✓	509147	0.2038
974-60306	34	1	25	6.86	✓	509161	0.2651
974-60308	34	1	25	7.88	✓	509185	0.4074
974-60310	34	1	10	3.65	✓	509208	0.1176
974-60315	34	1	10	29.70	✓	509215	0.8650
980-5	51	100	100	1.68		504531	0.0825
980-6	51	100	100	1.95		509260	0.0925
980-8	51	100	100	2.16		509277	0.1425
981-5	51	100	100	1.62		509284	0.0822
981-6	51	100	100	1.64		509291	0.1025
985-5	51	100	100	0.67		509307	0.0542
985-6	51	100	100	1.05		509314	0.0625
985-8	51	100	100	1.50		509321	0.0725
986-6	51	100	100	0.67		509338	0.0525
988-6	51	100	100	0.33		509345	0.0290
990-20385	51	25	300	0.39		509352	0.0095
990-7	51	100	1000	0.36		509376	0.0086
991-6	51	100	1000	0.18		509383	0.0058
995-20320	51	25	200	0.27		509390	0.0097
995-20330	51	25	200	0.40		509406	0.0111
995-20335	51	25	200	0.25		509413	0.0151
995-20340	51	25	200	0.17		509420	0.0093
995-5	51	100	1000	0.25		509437	0.0086
995-6	51	100	1000	0.22		509444	0.0106
995-8	51	100	1000	0.31		509451	0.0148
996-6	51	100	1000	0.17		509468	0.0058
996-8	51	100	1000	0.20		509475	0.0078
TH648QB220A	38	12	12	12.16	✓	406606	0.2925
TH648QB220S	38	12	12	12.65	✓	406613	0.2788
TH648QBD220A	38	12	12	18.25	✓	406644	0.3200
TH696-1020GF	67	6	6	27.75	✓	154354	1.6133
TH696-1021GF	67	6	6	30.25	✓	154361	1.6133
TH696-1031GF	67	6	6	33.40	✓	154378	2.0762
TH696R1020GF	67	10	10	71.97	✓	154385	1.4511
TH696R1021GF	67	10	10	74.47	✓	154392	1.8168
TH696R1031GF	67	10	10	77.62	✓	154408	2.1842

SAMPLES

TRY ME PACKS 116

TRY ME PACKS

You do not always want to buy first. Sometimes you need to field test a product to get a hands-on experience, to see if Tomahawk offers the quality, innovation and tested solutions that we say we do. Experience the Tomahawk edge by ordering a Try Me Pack, at no charge, for your real life on-the-job needs.



Try Me Pack No.	Item Description	Contents
SPECIALTIES		
X1291	Drip Free Washer	3 × 290-20301, 290-20311, 290-20313, 290-20381
X1292	Wedge-It	2 × 460-10, 460-20
X1295	Dry Seal Pipe Collar moisture barrier	5 × 928-2
X1296	Shower WallNut	1 × 614-8L, 622-L08, 616-02C, 523-2414
X1401	Plumb Perfect closet bolt	6 × 425 (nut), 430 (bolt)
X1901	Trim Tite escutcheon	5 × 920-2W
X1902	No Putty Gasket	2 × 290-20320, 290-20322, 290-20324
X1910	Smart Cap	2 × 440-2W, 440-2WPK, 442-2W, 442-2WPK
TOOLS		
X1300	Handsaws	1 × 300-12, 301-062

REFERENCE DATA

TECHNICAL 118

Pipe & Tube Dimensions

Hanger Spacing

Labor Cost Savings

MARKS & INSIGNIA 120

PIPE & TUBE DIMENSIONS

- 1 cubic ft of water weighs 62.41 lbs.
- 1 cubic meter of water weighs 100 kg.
- 1 gallon (US) of water weighs 8.335 lbs.
- 1 liter of water weighs 1 kg.

Copper water tube and copper sweat fittings are referenced by their nominal (nom) size, which approximates the inside diameter (I.D.) waterway of the tube (1/2" nom, 3/4" nom, etc.). Compression fittings are referenced by the outside diameter (O.D.) of the tube they connect to (5/8" O.D., 7/8" O.D., etc.). Copper water tube is manufactured to conform to ASTM Standard B 88.

Nominal Tube Size	O.D. Size (in.)	Wall Thickness (in.)	Weight of Tube (lbs/ft)	Weight of Pipe Full of Water (lbs/ft)
SCHEDULE 40 STEEL				
1/8"	0.405	0.068	0.2	0.4
1/4"	0.540	0.088	0.4	0.5
3/8"	0.675	0.091	0.6	0.7
1/2"	0.840	0.109	0.8	0.9
3/4"	1.050	0.113	1.1	1.3
1"	1.315	0.133	1.7	2.1
1 1/4"	1.660	0.140	2.3	2.9
1 1/2"	1.900	0.145	2.7	3.6
2"	2.375	0.154	3.6	5.0
2 1/2"	2.875	0.203	5.8	7.9
3"	3.500	0.216	7.6	10.8
3 1/2"	4.000	0.226	9.1	13.4
4"	4.500	0.237	10.8	16.3
SCHEDULE 40 PVC				
1/8"	0.405	0.068	0.04	0.06
1/4"	0.540	0.088	0.07	0.11
3/8"	0.675	0.091	0.10	0.18
1/2"	0.840	0.109	0.15	0.25
3/4"	1.050	0.113	0.20	0.40
1"	1.315	0.133	0.30	0.70
1 1/4"	1.660	0.140	0.40	1.00
1 1/2"	1.900	0.145	0.50	1.40
2"	2.375	0.154	0.60	2.00
2 1/2"	2.875	0.230	1.00	3.10
3"	3.500	0.216	1.30	4.50
3 1/2"	4.000	0.226	1.60	5.90
4"	4.500	0.237	1.90	7.40
SCHEDULE 40 CPVC				
1/4"	0.540	0.088	0.09	0.12
1/2"	0.840	0.109	0.19	0.28
3/4"	1.050	0.113	0.25	0.43
1"	1.315	0.133	0.38	0.76
1 1/4"	1.660	0.140	0.51	1.08
1 1/2"	1.900	0.145	0.61	1.49
2"	2.375	0.154	0.82	2.12
2 1/2"	2.875	0.230	1.29	3.29
3"	3.500	0.216	1.69	4.75
4"	4.500	0.237	2.33	7.68

Nominal Tube Size	O.D. Size (in.)	Wall Thickness (in.)	Weight of Tube (lbs/ft)	Weight of Pipe Full of Water (lbs/ft)
SCHEDULE 80 STEEL				
1/8"	0.405	0.095	0.3	0.4
1/4"	0.540	0.119	0.5	0.6
3/8"	0.675	0.126	0.7	0.8
1/2"	0.840	0.147	1.1	1.2
3/4"	1.050	0.154	1.5	1.7
1"	1.315	0.179	2.2	2.5
1 1/4"	1.660	0.191	3.0	3.5
1 1/2"	1.900	0.200	3.6	4.3
2"	2.375	0.218	5.0	6.3
2 1/2"	2.875	0.276	7.6	9.4
3"	3.500	0.300	10.2	13.0
3 1/2"	4.000	0.318	12.5	16.3
4"	4.500	0.337	15.0	20.0
SCHEDULE 80 PVC				
1/8"	0.405	0.095	0.05	0.06
1/4"	0.540	0.119	0.09	0.12
3/8"	0.675	0.126	0.10	0.16
1/2"	0.840	0.147	0.10	0.20
3/4"	1.050	0.154	0.20	0.40
1"	1.315	0.179	0.40	0.70
1 1/4"	1.660	0.191	0.50	1.00
1 1/2"	1.900	0.200	0.60	1.30
2"	2.375	0.218	0.90	2.20
2 1/2"	2.875	0.276	1.30	3.10
3"	3.500	0.300	1.80	4.60
3 1/2"	4.000	0.318	2.20	6.00
4"	4.500	0.337	2.60	7.60
SCHEDULE 80 CPVC				
1/4"	0.540	0.119	0.12	0.16
1/2"	0.840	0.147	0.24	0.31
3/4"	1.050	0.154	0.33	0.48
1"	1.315	0.179	0.49	0.85
1 1/4"	1.660	0.191	0.67	1.18
1 1/2"	1.900	0.200	0.81	1.61
2"	2.375	0.218	1.09	2.26
2 1/2"	2.875	0.276	1.65	3.49
3"	3.500	0.300	2.21	5.02
4"	4.500	0.337	3.23	8.08
SCHEDULE 80 POLYPRO				
1/2"	0.840	0.147	0.14	0.19
3/4"	1.050	0.154	0.19	0.33
1"	1.315	0.179	0.27	0.49
1 1/4"	1.660	0.191	0.38	0.85
1 1/2"	1.900	0.200	0.45	1.18
2"	2.375	0.218	0.62	1.61
SCHEDULE 80 PVDF				
1/2"	0.840	0.147	0.24	0.31
3/4"	1.050	0.154	0.33	0.48
1"	1.315	0.179	0.49	0.85
1 1/4"	1.660	0.191	0.67	1.18
1 1/2"	1.900	0.200	0.81	1.61
2"	2.375	0.218	1.13	2.26
COPPER TYPE K				
1/4"	0.375	0.035	0.14	0.17
3/8"	0.500	0.049	0.27	0.32

Nominal Tube Size	O.D. Size (in.)	Wall Thickness (in.)	Weight of Tube (lbs/ft)	Weight of Pipe Full of Water (lbs/ft)
½"	0.625	0.049	0.34	0.43
⅝"	0.750	0.049	0.42	0.56
¾"	0.875	0.065	0.64	0.83
1"	1.125	0.065	0.84	1.18
1 ¼"	1.375	0.065	1.04	1.57
1 ½"	1.625	0.072	1.36	2.10
2"	2.125	0.083	2.06	3.37
2 ½"	2.625	0.095	2.92	4.92
3"	3.125	0.109	4.00	6.96
3 ½"	3.625	0.120	5.12	9.02
4"	4.125	0.134	6.51	11.57
COPPER TYPE L				
¼"	0.375	0.030	0.12	0.15
⅜"	0.500	0.035	0.20	0.26
½"	0.625	0.040	0.28	0.38
⅝"	0.750	0.042	0.36	0.51
¾"	0.875	0.045	0.45	0.66
1"	1.125	0.050	0.65	1.01
1 ¼"	1.375	0.055	0.88	1.42
1 ½"	1.625	0.060	1.14	1.91
2"	2.125	0.070	1.75	3.09
2 ½"	2.625	0.080	2.48	4.54
3"	3.125	0.090	3.33	6.28
3 ½"	3.625	0.100	4.29	8.28
4"	4.125	0.110	5.38	10.57
COPPER TYPE M				
½"	0.625	0.028	0.204	0.314
¾"	0.875	0.032	0.328	0.551
1"	1.125	0.035	0.465	0.843
1 ¼"	1.375	0.042	0.682	1.25
1 ½"	1.625	0.049	0.940	1.73
2"	2.125	0.058	1.460	2.83
2 ½"	2.625	0.065	2.030	4.14
3"	3.125	0.072	2.680	5.70
3 ½"	3.625	0.083	3.580	7.64
4"	4.125	0.095	4.660	9.83
COPPER TYPE DWV				
1 ¼"	1.375	0.040	0.65	1.22
1 ½"	1.625	0.042	0.81	1.62
2"	2.125	0.042	1.07	2.48
3"	3.125	0.045	1.69	4.81
4"	4.125	0.058	2.87	7.88
CAST IRON EXTRA WEIGHT				
2"	2.38	0.190	5.0	6.6
3"	3.50	0.250	9.0	12.7
4"	4.50	0.250	12.0	18.5
CAST IRON SERVICE WEIGHT				
2"	2.25	0.17	4	5.5
3"	3.25	0.17	6	9.4
4"	4.25	0.18	8	14.2
NO-HUB CAST IRON				
1 ½"	1.90	0.16	2.7	6.2
2"	2.35	0.16	3.6	8.6
3"	3.35	0.16	5.2	13.5
4"	4.38	0.19	7.4	20.2

Hanger Spacing

Data from 2012 International Plumbing Code, Table 308.5.

Piping Material	Maximum Horizontal Spacing (ft)	Maximum Vertical Spacing (ft)
ABS pipe	4	10 ²
aluminum tubing	10	15
brass pipe	10	10
cast-iron pipe	5 ¹	15
copper or copper-alloy pipe	12	10
copper or copper alloy tubing, ≤ 1 ¼" diameter	6	10
copper or copper alloy tubing, ≥ 1 ½" diameter	10	10
PEX pipe	2.67	10 ²
PEX-AL-PEX pipe	2.67	4
CPVC pipe or tubing, ≤ 1"	3	10 ²
CPVC pipe or tubing, ≥ 1 ¼"	4	10 ²
steel pipe	12	15
lead pipe	continuous	4
PE-AL-PE pipe	2.67	4
PE-RT pipe	2.67	10 ²
PP pipe or tubing, ≤ 1"	2.67	10 ²
PP pipe or tubing, ≥ 1 ¼"	4	10 ²
PVC pipe	4	10 ²
stainless steel drainage systems	10	10 ²

- ¹ The maximum horizontal spacing of cast-iron pipe hangers shall be increased to 10 ft where 10-ft lengths of pipe are installed.
- ² Midstory guide for sizes 2" and smaller.

Labor Cost Savings

Money retained when saving time.

	2 min.	4 min.	6 min.	8 min.	10 min.
Labor Cost Per Hour Per Worker (wage + overhead + benefits + taxes) \$20.00	0.66	1.32	1.98	2.64	3.30
\$26.00	0.86	1.72	2.58	3.44	4.30
\$32.00	1.06	2.12	3.18	4.24	5.30
\$38.00	1.26	2.52	3.78	5.04	6.30
\$44.00	1.46	2.92	4.38	5.84	7.30
\$48.00	1.60	3.20	4.80	6.40	8.00
\$54.00	1.80	3.60	5.40	7.20	9.00
\$60.00	2.00	4.00	6.00	8.00	10.00
\$66.00	2.20	4.40	6.60	8.80	11.00
\$72.00	2.40	4.80	7.20	9.60	12.00

MARKS & INSIGNIA



No Lead

A mark used to signify items, categories or subsections that comply with the material requirements of the California Lead Plumbing Law and/or NSF-61 Annex G.



IPC

A mark used to signify items, categories or subsections that are in compliance with the International Plumbing Code.



ASSE

A mark used to signify items, categories or subsections that have been tested to and certified by ASSE to the applicable ASSE product standard.



UPC

A mark used to signify items, categories or subsections that have been listed by IAPMO and are in compliance with the Uniform Plumbing Code.



cUPC

A mark used to signify items, categories or subsections that have been listed by IAPMO and are in compliance with the Uniform Plumbing Code and the National Plumbing Code of Canada.



cIAPMO

A mark used to signify items, categories or subsections that have achieved a classified listing from IAPMO, for products that lie outside the scope of the Uniform Plumbing Code.



CSA

A mark used to signify items, categories or subsections that are certified by CSA to applicable national standards.



NSF

A mark used to signify items, categories or subsections that are certified by NSF to applicable national standards.



FGG/BM/CZ

A mark used to signify items, categories or subsections that are tested and monitored by NSF to assure chemical compatibility with FlowGuard Gold®, BlazeMaster® and Corzan®, registered trademarks of Lubrizol Corporation.



WH

A mark used to signify items, categories or subsections that are certified by Interetek/Warnock Hersey to applicable American and Canadian standards.

SALES & REPS

TOMAHAWK SERVICE TEAM 122

Customer Service
Sales

REPRESENTATIVES MAP & SHIPPING MAP 123

REPRESENTATIVES 124

TOMAHAWK SERVICE TEAM

Customer Service



Deanna
Dir CS & RS
x324



Michelle
CS Mgr
x231



Jane
Sales Admin Mgr
x315



Gina
CS Rep
x281



Mai
CS Rep
x211



Micah
CS Rep
x270



Jennifer
Sales Admin
x224



Evette
CS Rep
x249



Rebecca
CS Rep
x239



Crystal
CS Rep
x210



Marie
EDI Coord
x280



Pam
Retail Admin Asst
x312



Keri
Sales Admin
x228

Para servicio en Español favor de marcar la extensión 249.

P 1.800.821.3944
F 1.800.758.5950

Sales



Ed
VP - Sales & Mkt
x325



Wade
Nat'l Sales Mgr
x259



Michael
Regional Sales Mgr
x227



Mike
Regional Sales Mgr



Mitch
Regional Sales Mgr
x248



Brandon
Regional Sales Mgr
x327



Doug
Regional Sales Mgr
x306



Lilliard
Commercial
x251



Eric
Int'l & OEM
x326



Derrick
Retail
x314



Kirk
Factory Rep



Paul
Factory Rep



Kris
Inside Sales
x250



Jake
Inside Sales
x271



Randy
Inside Sales
x273



Rachel
Retail Sales
x341



John
Inside Sales
x282



Michael
Inside Sales
x337

P 816.779.6104
F 816.758.5950

PLUMBING

GAS

TOOLS

APPENDIX

REPRESENTATIVES MAP & SHIPPING MAP

PLUMBING

GAS

TOOLS

APPENDIX

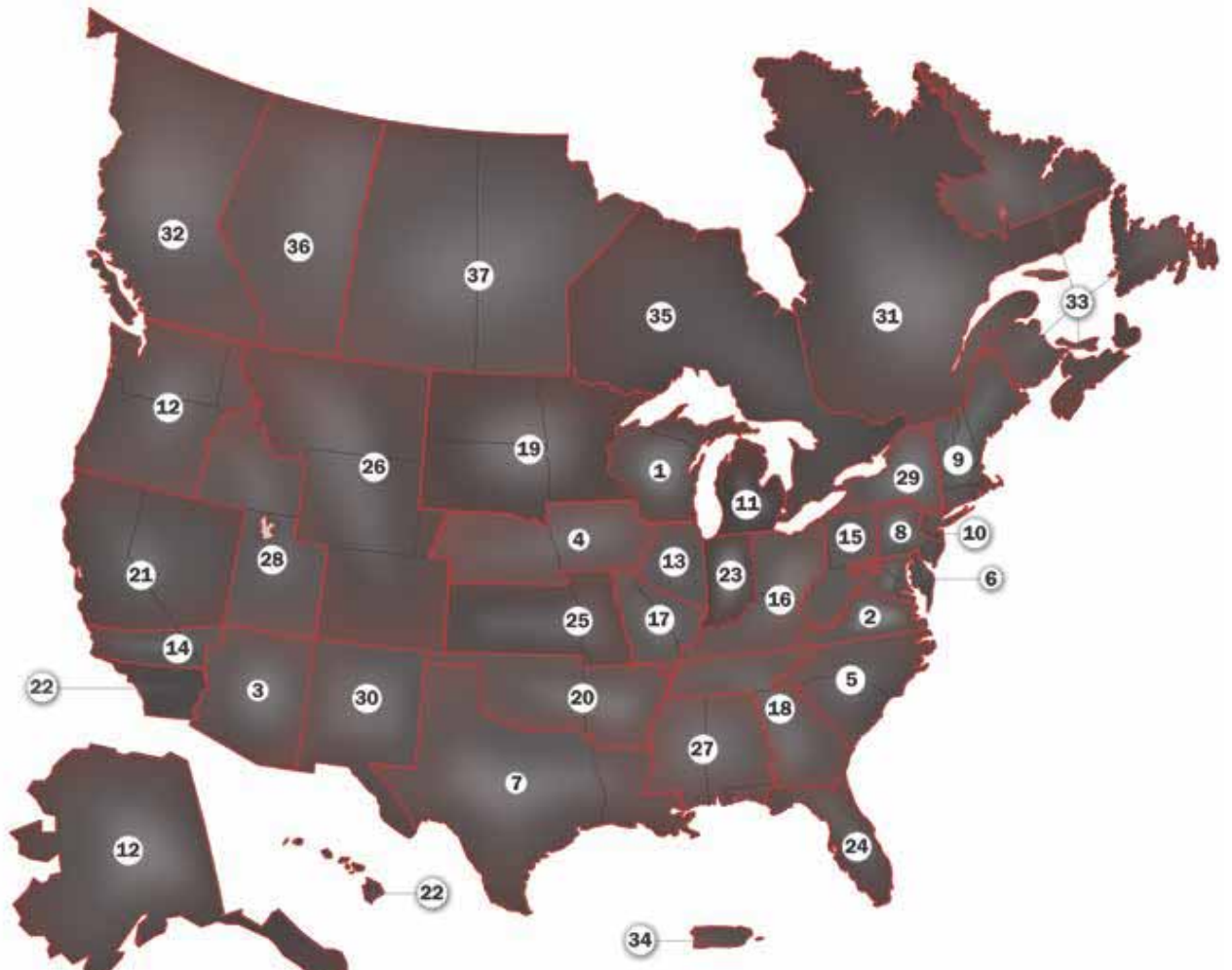

**FOR REPRESENTATIVE CONTACT INFO
SEE NEXT PAGE**

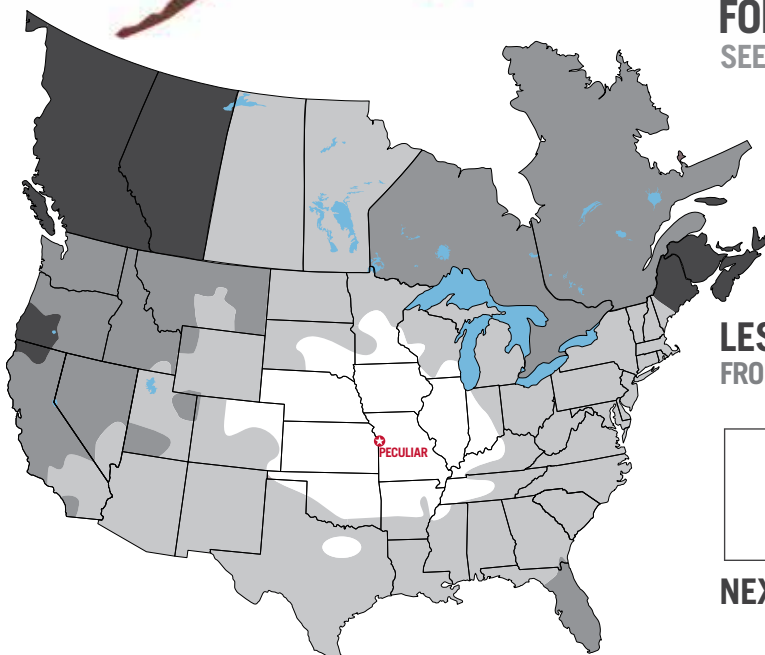

**LESS THAN TRUCKLOAD SHIPPING TIMES
FROM PECULIAR, MISSOURI**

1

NEXT DAY

2

2ND DAY

3

3RD DAY

4

4TH DAY

TOMAHAWK REPRESENTATIVES

COMPANY	PHONE	FAX	TERRITORY	WEBSITE OR EMAIL
USA				
01 Badgerland Trading of Wisconsin	(262) 827-3177	(262) 827-3176	upper MI, WI	badgerlandtrading.com
02 Barger Associates	(757) 873-4574	(757) 873-9530	southern VA	tolson@barger-assoc.com
03 Bobier Sales, Inc.	(602) 304-0001	(602) 304-0005	AZ	bobiersales.com
04 Bull's I Sales	(913) 649-8391	(913) 649-8594	IA, eastern and central NE	bullsisales.com
05 Carolina Sales Associates	(803) 831-7227	(803) 831-2565	NC, SC	carolinasalesassoc.com
06 Cathell & Associates	(410) 323-9881	(410) 433-1548	southern DE, DC, MD, northern VA	cathell.com
07 Champions Marketing	(281) 955-6580	(281) 351-1125	LA, TX (except El Paso)	championsmarketing.net
08 Cope-Wardell-Ammon Assoc., Inc.	(610) 485-2828	(610) 485-7171	southern NJ, eastern PA, northern DE	cwaassociates.com
09 Davenport Associates	(800) 875-2389	(800) 451-5941	CT, MA, ME, NH, RI, VT	davenportassociates.com
10 Dellon Sales Company, Inc.	(516) 625-2626	(516) 625-3030	New York, NY, northern NJ	dellonsales.com
11 Exceptional Product Sales	(586) 286-3240	(586) 286-3241	lower MI	expsa.com
12 Gordon & Associates	(360) 566-1470	(360) 566-1478	AK, northern ID, OR, WA	gordonandassoc.com
13 Hart, Travers & Associates	(800) 535-8525	(630) 261-1818	northern IL, northwest IN	harttraversassoc.com
14 Kirk Livernash	(702) 235-7635	(702) 476-3056	southern CA, southern NV (Bakersfield, Las Vegas) North of the Simi Valley and the San Fernando Valley	Kirk.Livernash@siouxchief.com
15 L & R Associates, Inc.	(412) 461-2476	(412) 461-2476	western PA, WV	landrassocinc.com
16 Lowder Sales, Inc.	(614) 451-7255	(614) 451-0450	KY, OH	lowdersales.com
17 M R Associates, Inc.	(314) 962-8960	(314) 962-2104	southern IL, eastern MO	marrassocinc.com
18 McKee-Nix & Associates, Inc.	(770) 934-8061	(770) 934-3233	GA, TN	mckeenix.com
19 Northland Reps	(952) 854-3905	(952) 854-5210	MN, ND, SD	northlandreps.com
20 NSC Marketing	(405) 602-2800	(405) 602-2824	AR, OK	N/A
21 Paramount Sales	(925) 373-0817	(925) 373-1048	northern CA, NV	paramountsales.biz
22 Paul Adelman	(760) 583-5726	(800) 758-5950	Los Angeles, CA, San Diego, CA, HI	Paul.Adelman@siouxchief.com
23 RL Sales, LLC	(317) 690-2269	N/A	IN	rlsales.net
24 RSL Sales Associates	(800) 538-4792	(352) 237-0438	FL peninsula	rslsales.com
25 SFE Enterprises, Inc.	(816) 322-2206	(816) 322-5560	KS, western MO	mmoore@sfe.cc
26 T M Sales	(303) 375-1515	(303) 375-0305	CO, MT, western NE, WY	tmsalesinc.com
27 Tim Morales & Associates, Inc.	(251) 602-8333	(251) 602-8339	AL, FL panhandle, MS	timmorales.com
28 Tony Sutherland	(801) 916-9853	(801) 290-2513	ID, UT	tonyevent@aol.com
29 Twin "D" Associates	(518) 862-9500	(518) 464-3410	upstate NY	twindassociates.com
30 W W Sales Company	(505) 878-0636	(505) 878-0638	NM, western TX (El Paso)	don@wwsalesco.com
CANADA/PUERTO RICO				
31 Can-Aqua International	(450) 625-3088	(450) 625-8617	QC	can-aqua.ca
32 Hy-Line Sales Ltd.	(604) 856-8684	(604) 831-2869	BC	hylinesales.com
33 MMS Mechanical Sales	(902) 826-2482	(902) 830-2353	NL, NB, NS, PE	munrobert@eastlink.ca
34 Reliable Sales Agency, Inc.	(787) 752-6690	(787) 752-6920	Puerto Rico	josereliablesales@gmail.com
35 TriSon Sales, Inc.	(289) 337-6012	(289) 337-6012	ON	trisonsales.com
36 Viper Sales & Marketing	(403) 663-5797	(403) 265-5779	AB	vipersales.ca
37 WestCan Mechanical Sales Ltd.	(306) 347-2700	(306) 359-3515	SK, MB	westcanmechanical@sasktel.net

WARRANTY

WARRANTY 126
Limited Lifetime Warranty
Terms & Conditions

ORDER FORM 128

WARRANTY

Limited Lifetime Warranty

Sioux Chief Mfg. Co., Inc. ("Seller" or "the Seller") warrants its products to be free from defects in material and workmanship under normal usage for the lifetime of the plumbing system in which they were originally incorporated. In the event of such defects within the warranty period, the Company will, at its option, replace or recondition the product without charge.

This remedy shall be effective only if the product was installed in accordance with supplied instructions, common installation or use practices and existing building and plumbing codes and legal requirements; has not been subjected to misuse or abuse; was at all times used in a manner consistent with its intended use; was at all times used in installations and environments acceptable to its material and design specifications; was never modified, altered or repaired by anyone other than the Seller; was properly subjected to and passed common testing methods (including pressure testing for potable water and drainage systems) immediately after the product's installation and before the product is put into service; was not damaged by freezing, corrosion, degradation or other adverse water, atmospheric or other natural conditions; was never subjected to improper protection during the installation or exposure to water pressures or temperatures outside acceptable operating conditions. In addition, Seller shall not be responsible for any incidental, special or consequential damages, including without limitation, lost profits or the cost of repairing or replacing other property which is damaged, other costs resulting from labor charges, delays, vandalism, negligence, fouling caused by foreign material, chemical or any other circumstances over which the Seller has no control. This warranty excludes all costs arising from routine maintenance, including the replacement of any parts required by such maintenance and the replacement of parts required by normal wear and tear. The Seller also reserves the right to modify, alter or improve its product, or parts thereof, at any time without incurring an obligation to notify or modify, alter, improve or replace any product, or parts thereof, previously sold. If, on any occasion, Seller waives any term or condition, this waiver is not to be construed as a continuing waiver. For the purposes of this warranty, the lifetime of the original plumbing system is defined as the lesser of 25 years or the time before the plumbing system was replaced or materially changed; all products with automatically or manually moving parts are excluded from the limited lifetime warranty and carry a 3-year limited warranty, subject to the remaining terms, conditions and limitations of the warranty. Some States do not allow or have other parameters governing limitations on how long an implied warranty lasts, and some States do not allow the exclusion or limitation of incidental or consequential damages. This Limited Warranty gives you specific legal rights, and you may have other rights that vary from State to State. You

should consult applicable state laws to determine your rights. THE WARRANTY SET FORTH HEREIN ABOVE AND BELOW IS GIVEN EXPRESSLY AND IS THE ONLY WARRANTY GIVEN BY THE COMPANY WITH RESPECT TO THE PRODUCT. THE COMPANY MAKES NO OTHER WARRANTIES, EXPRESS OR IMPLIED. THE COMPANY HEREBY SPECIFICALLY DISCLAIMS ALL OTHER WARRANTIES, EXPRESS OR IMPLIED, INCLUDING BUT NOT LIMITED TO THE IMPLIED WARRANTIES OF MERCHANTABILITY AND FITNESS FOR A PARTICULAR PURPOSE.

Terms & Conditions

All sales are subject to the Standard Terms and Conditions set forth on Sioux Chief's website at www.siouxchief.com. These terms include the following:

Returned Goods No material shall be returned without authorization. When credit is issued it will be at the price charged, less handling charges based on costs of reconditioning, boxing, etc. Products that are obsolete or made to special order are not returnable. No merchandise will be accepted by Seller as a return unless such return is authorized in writing by Seller.

Returned Goods & Warranty Service

In order to return product or receive warranty service, customers must obtain a Return Goods Authorization ("RGA") by contacting Seller using the following information:

MAIL: Customer Service Manager, Sioux Chief Manufacturing Company, Inc., P.O. Box 397, Peculiar, Missouri 64078

PHONE: 816-779-6104

FAX: 816-758-5950

EMAIL: info@siouxchief.com

Returned Goods Procedure

- RGA requests must reference Seller's order number, invoice number or the customer's P.O. number, and must be less than twelve months old.
- In order to be received, all returned material must be in multiples of the stated catalog minimum order quantity and in original condition.
- Specials or custom-made products are not considered normal stock and therefore cannot be returned, except in case of manufacturer's defect.
- Customers will be charged 25% of invoice price for product restocking.
- RGA is invalid if referenced product is not received within 90 days of an RGA issue date.
- Issuance of the RGA does not authorize the customer to deduct the value of the return; once product is received by Seller and found to be in acceptable condition, Seller will issue a credit memo for returned product when applicable.
- Seller reserves the right to deny, nullify or cancel an RGA at its discretion.
- Seller will only supply product credit for a return or warranty claim.
- Seller can reject a return for any reason at any time.

Warranty Procedure — Product & Property

- If there is a warranty claim on a part that involves property or other damage, Seller should be contacted by phone or in writing directly following the loss, and in no case later than 15 days of the date of alleged claim or failure and before any remediation or alteration of the loss site has been started; any notice beyond this time frame or after work has taken place to repair or change the loss site will materially affect the Seller's ability to adjudicate the claim and will void the warranty.
- The product in claim and/or its installation should not be modified before review by Seller; alteration of the alleged product or installation materially affects the Seller's ability to establish fault and voids the warranty.
- Upon submitting the claim according to this procedure and timing, claimant will receive a RGA number from Seller.
- With the RGA number, claimant should submit a formal report of the claim, including the date of the installation, a description of the problem and damage and pictures of the product and damage (if possible). This information should be sent to the above address at claimant's expense. Seller will not receive or process a claim without an RGA number.
- Seller will contact claimant with next steps, which may include a visit from a site investigator or other representatives of Seller, as Seller reserves the right to investigate all alleged loss sites.
- Seller shall not be responsible for shipping errors reported 10 days after receipt of material.
- Seller shall not be responsible for shipment shortages that are signed for as clear.

Full Freight Allowance

Sioux Chief will pay freight on all orders to single destinations totaling at least \$2,500 list price to locations within the 48 contiguous states (United States of America), at least \$3,500 list price to locations within Hawaii, Alaska and Canada and at least \$4,500 list price to locations within Puerto Rico.

Processing of Orders

All orders are processed immediately upon receipt and acceptance by Seller. Seller reserves the right to charge back to Buyer costs incurred from order cancellations or changes, and to consider additions as separate orders.

Price Changes

All prices quoted from time to time by Seller are subject to change without notice up to time of shipment. Invoice totals and discounts will be calculated out to the fourth decimal digit. If Buyer fails to give written notice of objection to Sioux Chief's order confirmation within ten (10) days after Buyer's receipt of Sioux Chief's confirmation of the purchase order, the order confirmation pricing becomes binding.

Minimum Order Quantities

A 10% surcharge will be applied to any item not purchased in multiples of the stated Minimum Quantity, except on drop-ship orders. Items with bold Minimum Quantities in the Numerical Index (back of catalog) can never be broken.





Please COPY this form for future orders

DATE		
PAGE	OF	

INSTRUCTIONS

1. Fill in all Bill to and Ship to information.
2. Complete one line for each item ordered and fully extend for item total. Add all lines for order total.
3. Fax or mail page(s) to factory, representative or wholesaler.

BILL TO

new address

Qualified wholesale distributors only

Purchase order no.		
Contact name		
Company		
Street address		
City		
State	Zip	
Phone	Fax	
Special instructions		

SHIP TO

new address

Leave blank if same as "bill to"

Purchase order no.		
Contact name		
Company		
Street address		
City		
State	Zip	
Phone	Fax	
Special instructions		

ORDER

	Item No.	Description	Qty.	List Price Each	List Price Total	Mult.	Net Price Total
	1						
	2						
	3						
	4						
	5						
	6						
	7						
	8						
	9						
	10						
	11						
	12						
	13						
	14						
	15						
Signature / Date			Order Totals				

www.goTomahawk.com

Tomahawk
 P.O. Box 397 24110 South Peculiar Drive
 Peculiar, Missouri 64078 USA
P 1.800.821.3944 or 816.779.6104
F 1.800.758.5950 or 816.758.5950
 www.goTomahawk.com
 info@goTomahawk.com





CONSIDER **GO TOMAHAWK.COM** AS YOUR **SPECIALTY PLUMBING INFORMATION EDGE.**

Tomahawk is working hard to supply you with the right information at the right time. From our new website and online catalog experience, information-packed posts that help build your business and brand via our social media presence on Facebook, YouTube and Twitter – you can connect with industry professionals, learn from our product videos and simply stay up-to-date. Our Specialty + (Right Information @ the Right Time) = Your Edge.

WEB /// FACEBOOK /// YOUTUBE /// TWITTER



Tomahawk 24110 South Peculiar Drive Peculiar, Missouri 64078
P 1.800.821.3944 | F 1.800.758.5950 | www.goTomahawk.com